



ASIM Instruments

A SOURCE OF QUALITY INSTRUMENTS

MESSAGE FROM C.E.O

Our aim is customer satisfaction by providing them quality products, prompt services and in time deliveries.

We are fully equipped to manufacture wide range of quality surgical instruments. We will continue to strive to improve quality of our products and ask ourselves, "How can we do it better".

To achieve the heights and peaks of everlasting success, we are providing our valued customers the quality products, timely services and related technical services. The contentment of our customers as well as our employees is a major part of our mission.

We are delighted to bring you our latest catalogue. This catalogue is just one part of our dynamic program of worldwide growth and expansion aimed at delivering quality products and services.

Regards,

ASIM INSTRUMENTS
C.E.O



Mian Asim Razzaq
Chief Executive



Profile

We at ASIM INSTRUMENTS Sialkot Pakistan, are the world-renowned manufacturers and exporters of the top-quality Surgical and Dental Instruments.

We have been exporting our instruments all over the world to amount to hundreds and thousands of instruments each year. In a very short amount of time, our company has grown immensely to offer a diverse product range as well as acquire international certifications proving to our customers that our words and our products, both are of the highest quality.

PRODUCT'S LINE

We are the original equipment manufacturers (OEM) for surgical and dental instruments. Our product depth covers thousands of instruments ranging from the typical instruments used in the clinic to sophisticated instruments required during surgeries. We deem, however, pertinent to submit further that the range and scope of our production activities is not limited only to our product literature. We can produce instruments even if not depicted in our catalogues provided we receive samples or photos or references from the world-renowned company's catalogue.

QUALITY / INNOVATION

At ASIM INSTRUMENTS, the quality is set in motion through motivated specifications planning by trained technical personnel. The computer aided designing and imaging provide visual instruments a set configuration, which simplifies each aspect of instrument manufacturing.

FUTURE ORIENTED

We are a forward-looking company, and are determined to cover more milestones so as to be the world leaders in our field in the days to come. We shall cooperate with you every way possible, and assure you to serve your business interests the best way possible.

COMMITMENT

Our commitment is to meet the changing needs of healthcare systems and to lead the industry by providing quality surgical instruments at competitive cost.

We understand the diverse needs of our customers and know that quality along with delivery times are the most important and common requirements of our customers from both the segments. This realization allows us to serve our customers in the most efficient and cost effective manner.

We are looking forward to serve you.

Quality Certifications

We are ISO 9001:2008, ISO 13485:2003 certified.
CE Mark approved.

- ☑ ISO 9001:2008
- ☑ ISO 13485:2008
- ☑ CE Mark



GUARANTEE

We have become an internationally recognizable name in many countries. This is because we believe in our quality. Hence, our products are 100% guaranteed to be free of all kind of defects in craftsmanship and materials.



OUR MISSION

Our mission is customer satisfaction by providing them quality products, prompt services and in time deliveries.

We are fully equipped to manufacture wide range of quality surgical instruments. We will continue to strive to improve quality of our products and ask ourselves, "How can we do it better".

To achieve the heights and peaks of everlasting success, we are providing our valued customers the quality products, timely services and related technical services. The contentment of our customers as well as our employees is a major part of our mission.





Latest Technologies

Our production departments are well equipped with the latest, machinery imported from Germany, Japan, Korea, USA and England, and well staffed with the expert technicians trained from our strategic joint venture network.



Forging to Finish

Asim Instruments has its own forging section that is responsible for manufacturing of quality dies and forgings for its products.

Production Capacity

Producing millions of instruments each year, we are planning to increase our capacity even further by establishing newer departments in order to cater growing customer demands.

01

**Scalpels
Skalpelle
Bisturíes**

Page 1 to 15



02

**Diagnostics
Diagnostik
Diagnóstico**

Page 16 to 21



03

**Anaesthesia
Narkose
Anestesia**

Page 22 to 37



04

**Scissors
Scheren
Tijeras**

Page 38 to 64



05

**Super-Cut Scissors
Super-Cut Scheren
Tijeras Super-Cut**

Page 65 to 74



06

**TC Scissors
TC Scheren
Tijeras TC**

Page 75 to 84



07

**TC Super-Cut Scissors
TC Super-Cut Scheren
Tijeras Super-Cut TC**

Page 85 to 86



08

Dressing & Tissue Forceps
Anatomische und Chirurgische
Pinzetten
Pinzas de diseccion con dientes

Page 87 to 110



09

TC Forceps
TC-Zange
Pinzas TC

Page 111 to 114



10

Titanium Forceps
Titan-Pinzetten
Pinzas de titanio

Page 115 to 116



11

Artery Forceps
Arterienklemmen
Pinzas hemostáticas

Page 117 to 157



12

Cotton Swab Forceps
Tupfer-und Kornzangen
Pinzas para tapones y curaciones

Page 158 to 163



13

Probes, Applicators, Spatulas
Sonden, Watteträger, Spatel
Sondas, Porta-algodones, Espátula

Page 164 to 169



14

Bone Surgery
Knochenchirurgie
Cirugía ósea

Page 170 to 268



15

**Plaster Instruments
Plaster Instrumente
Instrumentos de yeso**

Page 269 to 274



16

**Retractors
Wundhaken und -sperrer
Separadores**

Page 275 to 345



17

**Suture
Naht
Sutura**

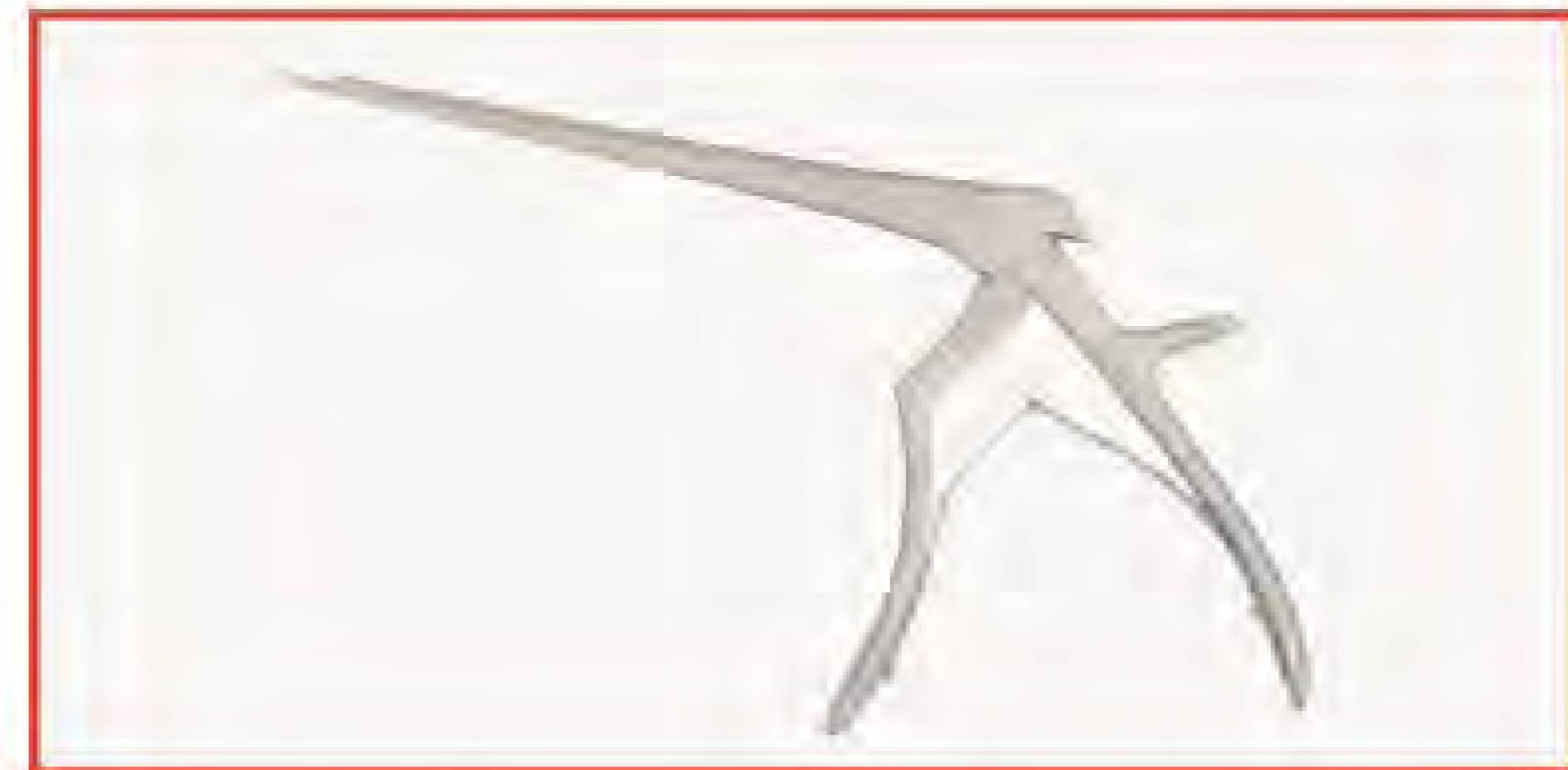
Page 346 to 372



18

**Neurosurgery
Neurochirurgie
Neuro Cirugía**

Page 378 to 387



19

**Cardiovascular Surgery
Herz- und Gefäßchirurgie
Cirugía cardiovascular**

Page 388 to 498



20

**Tonsil
Mandel
Amígdala**

Page 499 to 511



21

**Otology
Otologie
Otología**

Page 512 to 540



22

**Rhinology
Rhinologie
Rinología**

Page 541 to 574



23

**Oral Instruments
Mund instrumente
Cirugía oral**

Page 575 to 594



24

**Stomach, Intestine, Rectum
Magen, Darm, Mastdarm
Estómago, Intestinos, Recto**

Page 595 to 619



25

**Kidney, Liver, Gall Stone, Urology
Niere, Leber, Galle, Urologie
Riñón, Hígado, Bilis, Urología**

Page 620 to 638



26

**Dermatology
Dermatologie
Dermatología**

Page 639 to 640



27

**Tracheotomy
Tracheotomie
Traqueotomía**

Page 641 to 650



28

**Ophthalmology
Ophthalmologie
Oftalmología**

Page 651 to 681



29

**Gynecology
Gynäkologie
Ginecología**

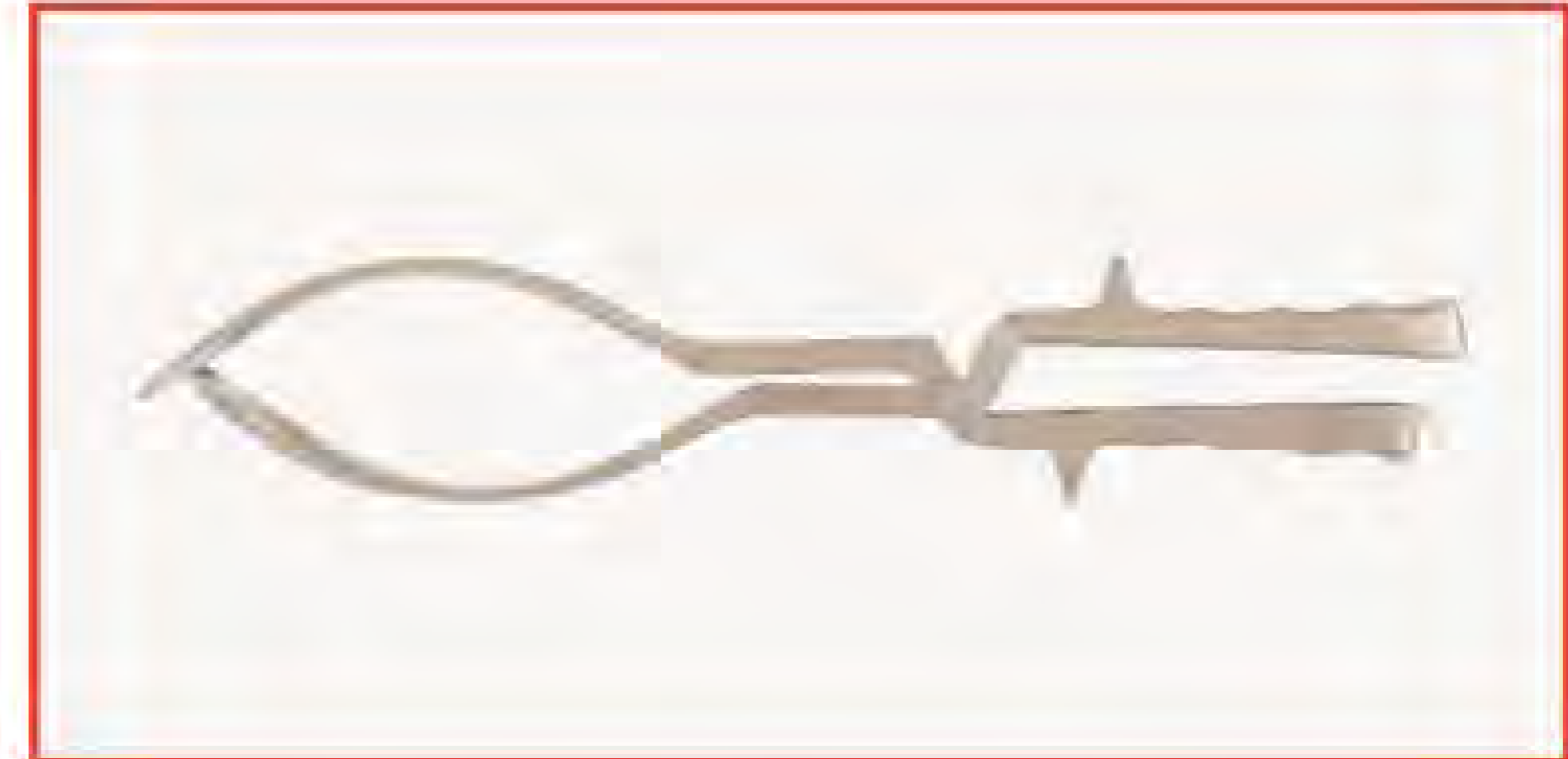
Page 682 to 722



30

**Obstetrics
Geburtshilfe
Obstetricia**

Page 723 to 740



31

**Goitre
Kropfchirurgie
Bocio**

Page 741



32

**Sterilization
Sterilisation
Esterilización**

Page 742 to 743



33

**Asepsis
Asepsis
Asepsia**

Page 744 to 745



34

**Hollowware
Holloware
Hollowware**

Page 746 to 753



EN Scalpels

DE Skalpelle

ES Bisturías

Page 1 to 15





Standard
 Ai 01-1000-04
 # 4

Ai 01-1001-4L # 4L
 Ai 01-1001-4XL # 4XL

Ai 01-1002-4L # 4L
 Ai 01-1002-4XL # 4XL
 angled

Ai 01-1003-07
 # 7

Ai 01-1004-07
 # 7K

Collin
 Ai 01-1005-08
 Fig. 8



Standard
 Ai 01-1006-03 # 3



Ai 01-1007-03 # 3



Ai 01-1008-04 # 4



Ai 01-1009-3L # 3L
 Ai 01-1009-3XL # 3XL



Ai 01-1010-3L # 3L
 Ai 01-1010-3XL # 3XL angled





Collin
Ai 01-1011-09
Hollow, No. 9



Super
Ai 01-1012-10
Hollow, No. 10



Ai 01-1013-00
Hollow, round



Ai 01-1014-00
Plastics



17cm/6¾"



Fig. 1

Ai 01-1015-01



Fig. 2

Ai 01-1015-02



Fig. 3

Ai 01-1015-03



Fig. 4

Ai 01-1015-04



Fig. 5

Ai 01-1015-05



Fig. 6

Ai 01-1015-06



Fig. 7

Ai 01-1015-07



Fig. 8

Ai 01-1015-08



Fig. 9

Ai 01-1015-09



Fig. 10

Ai 01-1015-10





Fig. 1 Ai 01-1016-01 Fig. 2 Ai 01-1016-02 Fig. 3 Ai 01-1016-03 Fig. 4 Ai 01-1016-04 Fig. 5 Ai 01-1016-05 Fig. 6 Ai 01-1016-06 Fig. 7 Ai 01-1016-07 Fig. 8 Ai 01-1016-08 Fig. 9 Ai 01-1016-09



17cm/6 3/4"

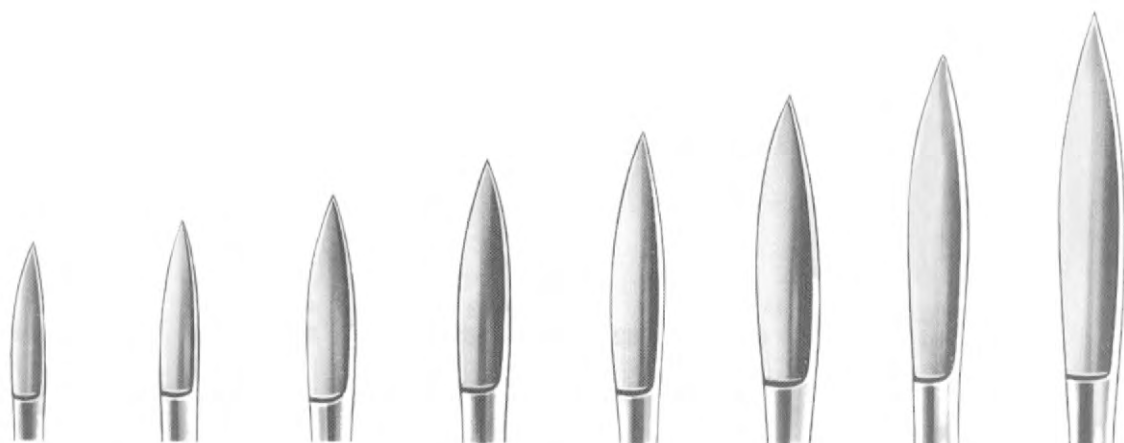


Fig. 10 Ai 01-1016-10 Fig. 11 Ai 01-1016-11 Fig. 12 Ai 01-1016-12 Fig. 13 Ai 01-1016-13 Fig. 14 Ai 01-1016-14 Fig. 15 Ai 01-1016-15 Fig. 16 Ai 01-1016-16 Fig. 18 Ai 01-1016-18



Fig. 27 Ai 01-1016-27 Fig. 38 Ai 01-1016-38 Fig. 40 Ai 01-1016-40 Fig. 46 Ai 01-1016-46 Fig. 61 Ai 01-1016-61 Fig. 63 Ai 01-1016-63



Dieffenbach
17cm/6¾"



Fig. 1
Ai 01-1017-01



Fig. 2
Ai 01-1017-02



Fig. 3
Ai 01-1017-03



Fig. 4
Ai 01-1017-04



Fig. 5
Ai 01-1017-05



Fig. 6
Ai 01-1017-06



Fig. 7
Ai 01-1017-07



Fig. 8
Ai 01-1017-08



Fig. 9
Ai 01-1017-09



Fig. 15
Ai 01-1017-15



Fig. 16
Ai 01-1017-16





◀ Fig. 1

Bergmann
 Ai 01-1018-01
 14.5cm/5¾"



Fig. 2
 Ai 01-1018-02



Fig. 3
 Ai 01-1018-03



Fig. 4
 Ai 01-1018-04



Dieffenbach
 13cm/5¼"



Fig. 1
 Ai 01-1019-01



Fig. 2
 Ai 01-1019-02



Fig. 3
 Ai 01-1019-03



Fig. 4
 Ai 01-1019-04



Fig. 5
 Ai 01-1019-05



Fig. 6
 Ai 01-1019-06



Fig. 7
 Ai 01-1019-07



Fig. 8
 Ai 01-1019-08



Fig. 9
 Ai 01-1019-09



Fig. 10
 Ai 01-1019-10



Fig. 11
 Ai 01-1019-11



Fig. 12
 Ai 01-1019-12



Simon
20cm/8"



Fig. 1
Ai 01-1020-01



Fig. 2
Ai 01-1020-02



Fig. 3
Ai 01-1020-03



Fig. 4
Ai 01-1020-04



Ulrich
22.5 cm/9"



Fig. 1
Ai 01-1021-01



Fig. 2
Ai 01-1021-02



Fig. 3
Ai 01-1021-03



Simon
23.5 cm/9 1/4"



Fig. 1
Ai 01-1022-01



Fig. 2
Ai 01-1022-02



Fig. 3
Ai 01-1022-03



Fig. 4
Ai 01-1022-04



Ai 01-1023-07
7.5 cm/3"



Ai 01-1024-08
8 cm/3 1/4"





Brain knives



Post mortem knives



Autopsy knives



Virchow

Ai 01-1025-16 26cm
Blade Size 160mm

Ai 01-1025-20 33.5cm
Blade Size 200mm

Ai 01-1025-24 38cm
Blade Size 240mm

Walb

Ai 01-1026-11 26cm
Blade Size 110mm

Ai 01-1026-14 29cm
Blade Size 140mm

Ai 01-1026-17 31cm
Blade Size 170mm

Ai 01-1027-10 25.5cm
Blade Size 100mm

Virchow

Ai 01-1028-08
8.5 cm



Collin

Liston

Catlin

Langenbeck

Phalangeal knife

Flap knife

Length of blades

cm	in	
9.5	3 3/4	
11.0	4 1/2	
12.0	4 3/4	
13.0	5	Ai 01-1029-13
15.0	6	
16.0	6 1/4	Ai 01-1029-16
17.0	6 3/4	
19.0	7 1/2	Ai 01-1029-19
20.0	8	
22.0	8 3/4	Ai 01-1029-22
28.0	11	Ai 01-1029-28

Ai 01-1031-11

Ai 01-1032-12

Ai 01-1033-09

Ai 01-1031-16

Ai 01-1031-19

Ai 01-1031-22

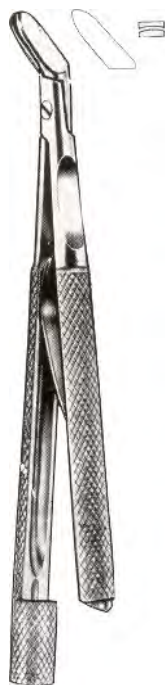
Ai 01-1030-17

Ai 01-1030-20





Troutman-Chris
Ai 01-1034-09
9 cm/3½"



Troutman-Chris
Ai 01-1035-09
9cm/3½"



Ai 01-1036-11
11cm/4½"



Castroviejo
Ai 01-1037-13
13cm/5¼"

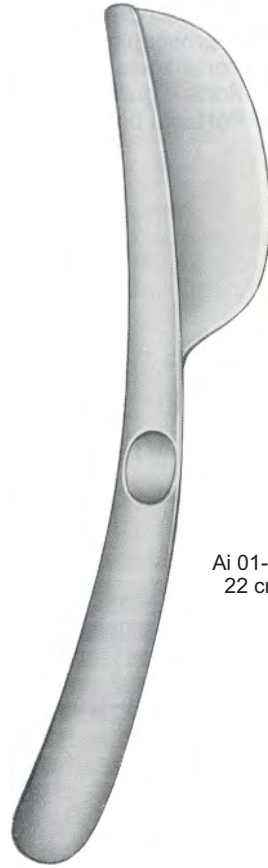


Ai 01-1038-18
18cm/7"



Skull Breaker

Ai 01-1039-14
 14 cm/5½"



Rachiotome

Ai 01-1040-22
 22 cm/8¾"



23 mm

Osteotome

Ai 01-1041-13
 13 cm/5"



Brunetti

Ai 01-1042-28

Brunetti

Ai 01-1043-28

28.5 cm/11¼"

Muscle hooks



Ai 01-1044-06

6.5 cm/2½"



Ai 01-1045-07

7 cm/2¾"



Ai 01-1046-01





Microscopic needles



Ai 01-1047-13
13 cm/5"



Ai 01-1048-13
13 cm/5"



Kalle
Ai 01-1049-24
24 cm/ 9 1/2"

Microscopic needle holder



Ai 01-1050-06
6 cm/2 1/4"

Loop for needle holder

Post mortem needles



Ai 01-1051-01

Ai 01-1051-02

Ai 01-1051-03

Ai 01-1051-04

Ai 01-1051-05

Ai 01-1051-06

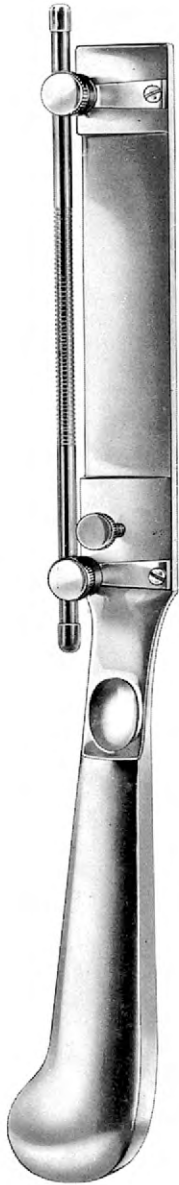


Ai 01-1052-00



Ai 01-1053-00

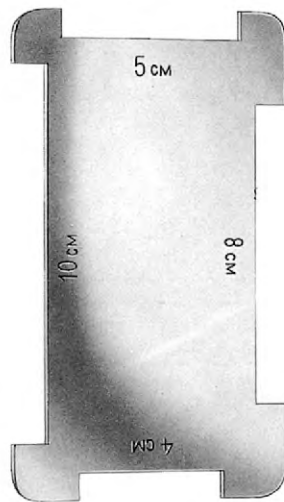




SCHINK
 Ai 01-1054-30
 30 cm/12"



Ai 01-1054-01



Ai 01-1055-00



HUMBY
 Ai 01-1056-31
 31 cm/12 1/2"



Ai 01-1056-01



SILVER
 Ai 01-1057-19
 19.5 cm/7 3/4"

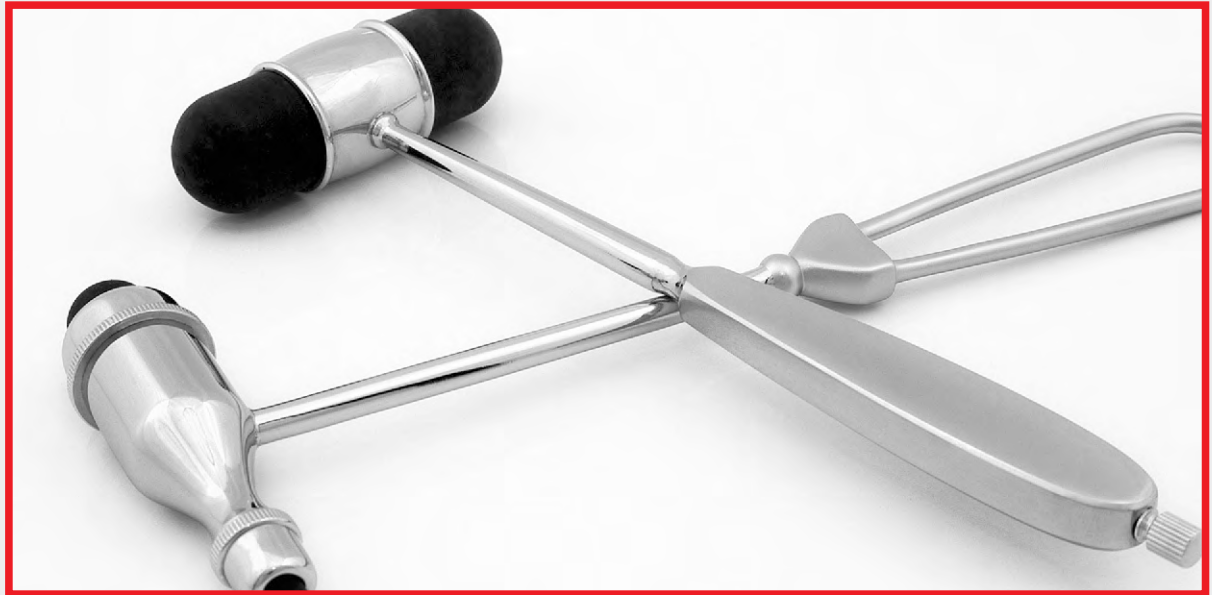


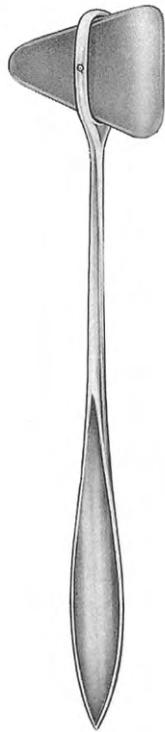
EN Diagnostics

DE Diagnostik

ES Diagnóstico

Page 16 to 21





Taylor
 Ai 02-1101-18 18 cm/7 1/2"
 Ai 02-1101-20 20 cm/8"



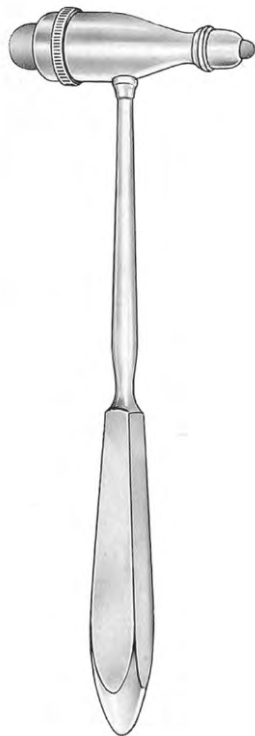
Dejerine
 Ai 02-1102-20 20 cm/8"



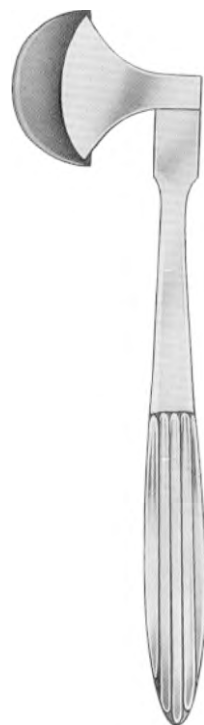
Dejerine
 Ai 02-1103-21 21 cm/8 1/2"
 Ai 02-1103-35 35 cm/14"



Neuro-Duoflex
 Ai 02-1104-22 22 cm/8 3/4"



Troemner
 Ai 02-1105-24 24 cm/9 3/4"



Berliner
 Ai 02-1106-17 17cm/7"
 Ai 02-1106-20 20cm/8"



Buck
 Ai 02-1107-18 18 cm/7 1/2"



Buck (Telescopic)
 Ai 02-1108-18 18 cm/7 1/2"



Traube
 Ai 02-1109-16
 16 cm/6 1/4"



Troemner
 Ai 02-1110-21
 21cm/8 1/4"



Divers-Duoflex
 Ai 02-1111-22
 22 cm/8 3/4"



Babinsky
 Ai 02-1112-22 22 cm/8 3/4"
 Ai 02-1112-25 25 cm/10"

Rabiner
 Ai 02-1113-23
 23 cm/9 1/4"



National Hospital
 Ai 02-1114-50 50 mm Ø
 Ai 02-1114-60 60 mm Ø
 Ai 02-1114-70 70 mm Ø
 33 cm/13"



Queen Sqaure
 Ai 02-1115-26
 26 cm/10 1/4"





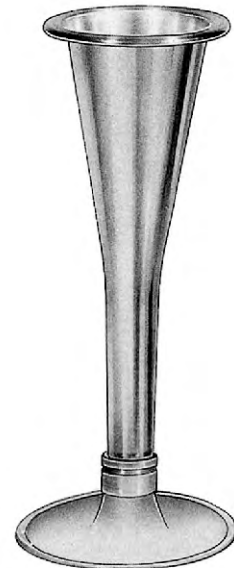
Pinard
 Ai 02-1116-18
 18 cm/7 1/2"
 (wooden)



Pinard
 Ai 02-1117-15
 15 cm/6"
 (plastic)



Pinard
 Ai 02-1118-15
 15 cm/6"
 (aluminum)



Pinard
 Ai 02-1119-15
 15 cm/6"
 (aluminum)



Aly
 Ai 02-1120-17
 17cm/6 3/4"



Wartenberg
 Ai 02-1121-19
 19cm/7 1/2"

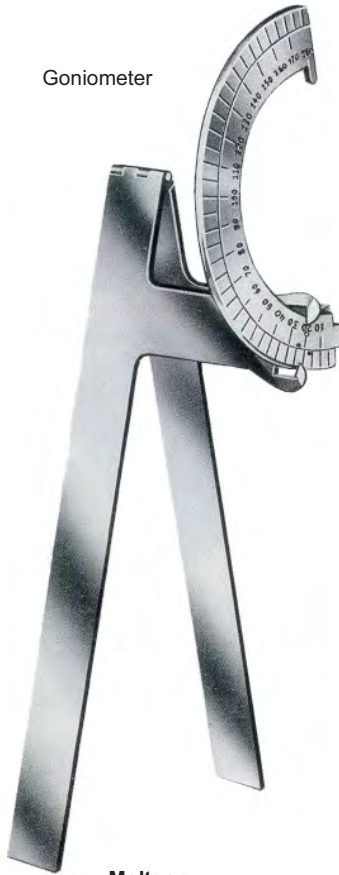


Weber
 Ai 02-1122-09
 9cm/3 1/2"



Ai 02-1123-15 15 cm/6"
 Ai 02-1123-30 30 cm/12"
 Ai 02-1123-60 60 cm/24"

Goniometer



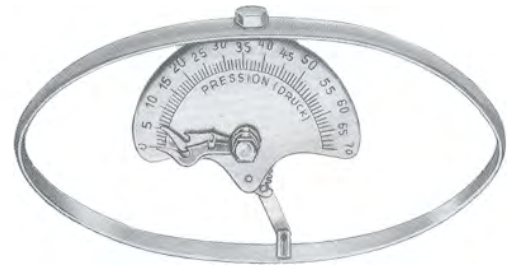
Moltgen
 Ai 02-1124-00



Townley
 Ai 02-1125-10
 10cm/4"



Caroll
 Ai 02-1126-14
 14cm/5 1/2"



Collin
 for children Ai 02-1127-01
 for adults Ai 02-1127-02



Ford Stethoscope
 Ai 02-1128-00
 Double Sided



Dual Stethoscope
 Ai 02-1129-00
 Single Sided

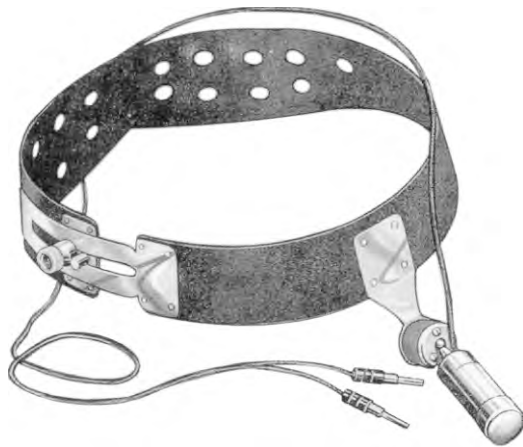




Ai 02-1130-00
Head Lamp



Ai 02-1131-00
Head Lamp



Ai 02-1132-00
Head Lamp



Jansen
Ai 02-1133-00
Head Lamp

Available in conventional and fiber



Ai 02-1134-00
Otoscope set in Case



Ai 02-1135-00
Otoscope set in Pouch



Ai 02-1136-00
Ophthalmoscope set



Ai 02-1137-00
Ophthalmoscope and Otoscope set



Ai 02-1138-00
Complete ENT set



EN Anaesthesia

DE Narkose

ES Anestesia

Page 22 to 37





Ai 03-1204-00
Battery handle



fiber optic



McINTOSH
with fiberoptic

Ai 03-1201-00
set with 4 blades, battery handle
(without batteries)
Fig. 1 to 4, in case

Ai 03-1202-00
set with 3 blades, battery handle
(without batteries)
Fig. 1 to 3, in case



Ai 03-1203-00
Fig. 0
for babies
55 mm



Ai 03-1203-01
Fig. 1
for children
70 mm



Ai 03-1203-02
Fig. 2
for adolescents
80 mm



Ai 03-1203-03
Fig. 3
for women
105 mm



Ai 03-1203-04
Fig. 4
for men
130 mm



FOREGGER
 with fiberoptic

Ai 03-1205-00
 set with 4 blades, battery handle
 (without batteries)
 Fig. 1 to 4, in case

Ai 03-1205-01
 set with 3 blades, battery handle
 (without batteries)
 Fig. 2 to 4, in case



Ai 03-1204-00
 Battery handle



Laryngoscope Sets
 fiber optic



Ai 03-1206-00
 Fig. 0
 for babies
 55 mm



Ai 03-1206-01
 Fig. 1
 for children
 70 mm



Ai 03-1206-02
 Fig. 2
 for adolescents
 90 mm



Ai 03-1206-03
 Fig. 3
 for women
 110 mm



Ai 03-1206-04
 Fig. 4
 for men
 135 mm





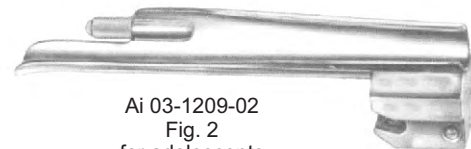
FOREGGER
 Ai 03-1207-00
 set with 3 blades
 Fig. 2 to 4, in case



FOREGGER
 Ai 03-1208-00
 set with 4 blades
 in case
 Fig. 1 to 4, in case



Ai 03-1209-01
 Fig. 1
 for children
 70 mm



Ai 03-1209-02
 Fig. 2
 for adolescents
 90 mm



Ai 03-1209-03
 Fig. 3
 for women
 110 mm



Ai 03-1209-04
 Fig. 4
 for men
 135 mm



Ai 03-1210-00
Battery handle



Ai 03-1211-00
Battery handle



Ai 03-1212-00
Battery handle



Ai 03-1213-00
spare bulb small
for blades fig. 0 to 1



Ai 03-1214-00
spare bulb large
for blades fig. 2 to 4





MILLER
 Ai 03-1215-00
 with battery handle (without batteries)
 and three laryngoscope blades
 fig. 1 to 3, complete, in case

MILLER
 Ai 03-1216-00
 with battery handle (without batteries)
 and four laryngoscope blades
 fig. 1 to 4, complete, in case



Laryngoscope Sets
 fiber optic



Ai 03-1217-00
 Fig. 0
 for babies
 55 mm



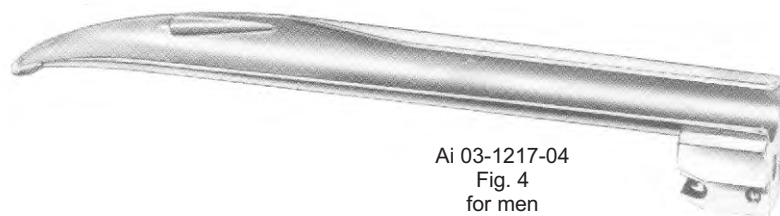
Ai 03-1217-01
 Fig. 1
 for children
 80 mm



Ai 03-1217-02
 Fig. 2
 for adolescents
 130 mm



Ai 03-1217-03
 Fig. 3
 for women
 170 mm



Ai 03-1217-04
 Fig. 4
 for men
 180 mm





MILLER

Ai 03-1218-00
 set with 4 blades, battery handle
 (without batteries)
 Fig. 1 to 4, in case

MILLER-BABY

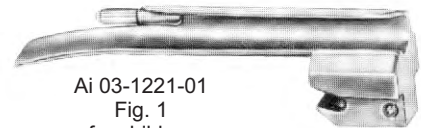
Ai 03-1219-00
 set with 2 blades, battery handle
 (without batteries)
 Fig. 0 & 1, in case

MILLER

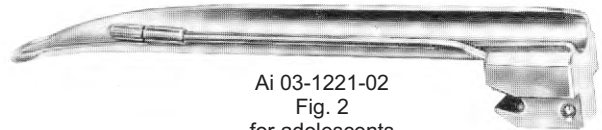
Ai 03-1220-00
 set with 3 blades, battery handle
 (without batteries)
 Fig. 1 to 3, in case



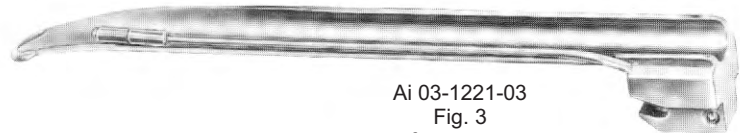
Ai 03-1221-00
 Fig. 0
 for children
 55 mm



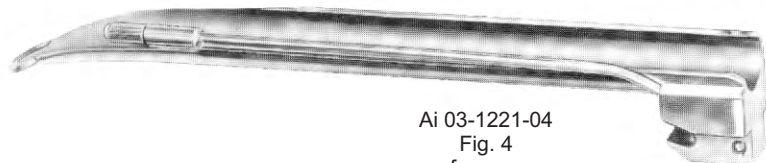
Ai 03-1221-01
 Fig. 1
 for children
 80 mm



Ai 03-1221-02
 Fig. 2
 for adolescents
 130 mm



Ai 03-1221-03
 Fig. 3
 for women
 170 mm



Ai 03-1221-04
 Fig. 4
 for men
 180 mm





GUEDEL-NEGUS
 Ai 03-1222-00
 set with 4 blades
 Fig. 1 to 4, in case

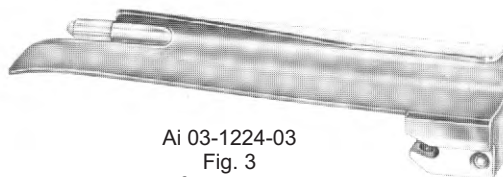
GUEDEL-NEGUS
 Ai 03-1223-00
 set with 3 blades
 Fig. 2 to 4, in case



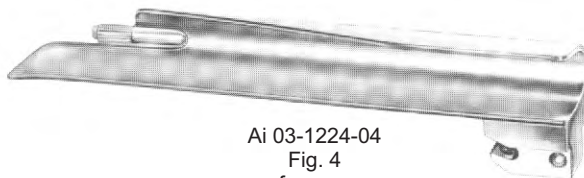
Ai 03-1224-01
 Fig. 1
 for children
 70 mm



Ai 03-1224-02
 Fig. 2
 for adolescent
 90 mm



Ai 03-1224-03
 Fig. 3
 for women
 110 mm



Ai 03-1224-04
 Fig. 4
 for men
 135 mm





MCINTOSH
 Ai 03-1225-00
 set with 3 blades
 Fig. 1 to 3, in case



MCINTOSH
 Ai 03-1226-00
 set with 4 blades
 Fig. 1 to 4, in case



Ai 03-1227-00
 Fig. 0
 for babies
 55 mm



Ai 03-1227-01
 Fig. 1
 for children
 70 mm



Ai 03-1227-02
 Fig. 2
 for adolescent
 90 mm



Ai 03-1227-03
 Fig. 3
 for women
 110 mm



Ai 03-1227-04
 Fig. 4
 for men
 130 mm





fiber optic



Ai 03-1228-00
 Battery handle (without batteries)
 with halogen bulb and green ring



Ai 03-1229-00
 Battery handle (without batteries)
 with halogen bulb and green ring



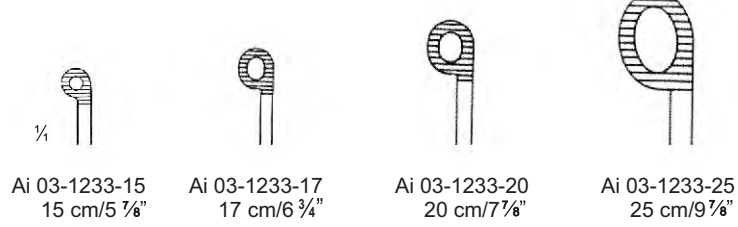
Ai 03-1230-00
 Spare bulb
 Krypton 2.5 V



Ai 03-1231-00
 Spare bulb
 Xenon 2.5 V

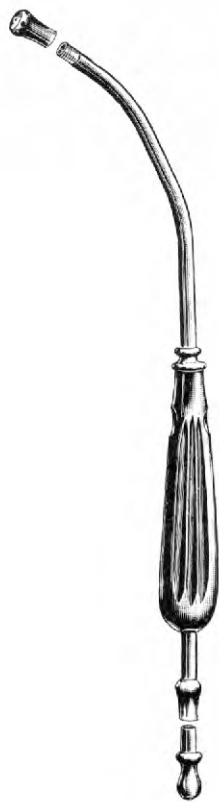


Ai 03-1232-00
 Spare bulb
 Halogen 2.5 V



MAGILL





YANKAUER
 Ai 03-1234-31
 31 cm/12 1/4"
 with suction tip & connector

Fig. 1
 Ai 03-1234-01



Fig. 2
 Ai 03-1234-02

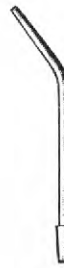


Fig. 3
 Ai 03-1234-03



Fig. 4
 Ai 03-1234-04



Ai 03-1235-00



YANKAUER
 Ai 03-1235-31
 (complete set)
 31 cm/12 1/4"



POOLE
 Ai 03-1236-24
 24 cm/9 1/2"
 10 Ø



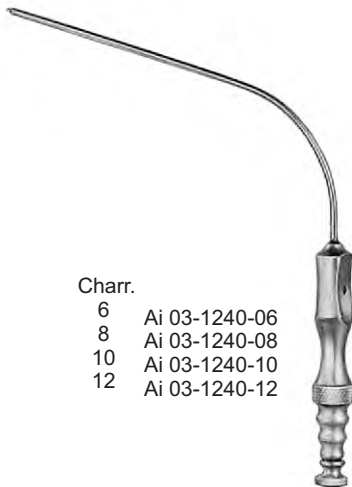
POOLE
 Ai 03-1237-25
 25 cm/9 7/8"
 8 Ø



ADSON
 Ai 03-1238-21
 21 cm/8 1/4"
 4mm Ø



PLESTER
 Ai 03-1239-01 1.5mm Ø
 Ai 03-1239-02 2.0mm Ø
 Ai 03-1239-03 2.5mm Ø
 Ai 03-1239-04 3.0mm Ø
 19.5 cm/7 3/4"



Charr.
 6 Ai 03-1240-06
 8 Ai 03-1240-08
 10 Ai 03-1240-10
 12 Ai 03-1240-12

POPPE
 13 cm/5 1/8"



Charr.
 6 Ai 03-1241-06
 7 Ai 03-1241-07
 8 Ai 03-1241-08
 9 Ai 03-1241-09
 10 Ai 03-1241-10
 11 Ai 03-1241-11
 12 Ai 03-1241-12

FRAZIER
 19 cm/7 1/2"

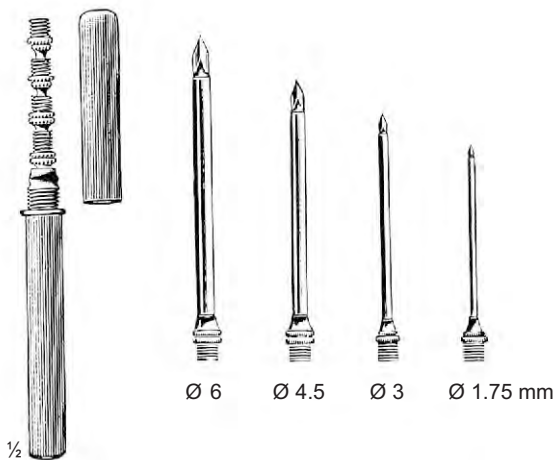




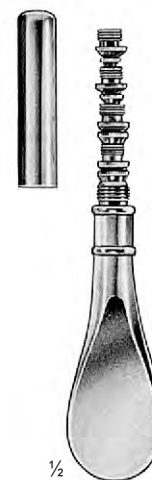
HYDROCELE
 Ai 03-1242-08 8 Fg.
 Ai 03-1242-09 9 Fg.
 Ai 03-1242-10 10 Fg.



ACITES
 Ai 03-1243-16 16 Fg.
 Ai 03-1243-21 21 Fg.



UNIVERSAL
 Ai 03-1244-30 Set of 3
 Ai 03-1244-40 Set of 4

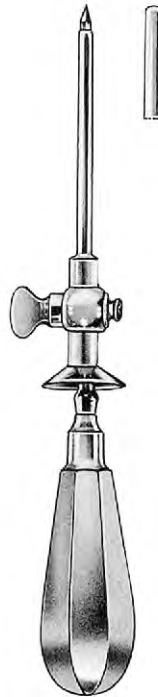


UNIVERSAL
 Ai 03-1245-30 Set of 3
 Ai 03-1245-40 Set of 4



STANDARD

- Ai 03-1246-01 Ø 3.0 mm
- Ai 03-1246-02 Ø 3.5 mm
- Ai 03-1246-03 Ø 4.0 mm
- Ai 03-1246-04 Ø 4.5 mm
- Ai 03-1246-05 Ø 5.0 mm
- Ai 03-1246-06 Ø 5.5 mm
- Ai 03-1246-07 Ø 6.0 mm



STANDARD

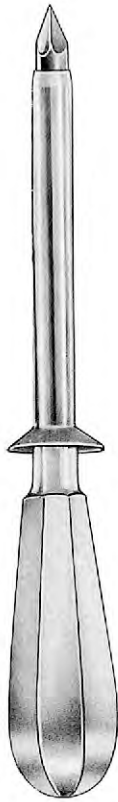
- Ai 03-1247-01 Ø 3.0 mm
- Ai 03-1247-02 Ø 3.5 mm
- Ai 03-1247-03 Ø 4.0 mm
- Ai 03-1247-04 Ø 4.5 mm
- Ai 03-1247-05 Ø 5.0 mm
- Ai 03-1247-06 Ø 5.5 mm
- Ai 03-1247-07 Ø 6.0 mm



STANDARD

- Ai 03-1248-01 Ø 3.0 mm
- Ai 03-1248-02 Ø 3.5 mm
- Ai 03-1248-03 Ø 4.0 mm
- Ai 03-1248-04 Ø 4.5 mm
- Ai 03-1248-05 Ø 5.0 mm
- Ai 03-1248-06 Ø 5.5 mm
- Ai 03-1248-07 Ø 6.0 mm





NELSON
 21 cm/8 1/4"



Fig. 1
 Ai 03-1249-01



Fig. 2
 Ai 03-1249-02

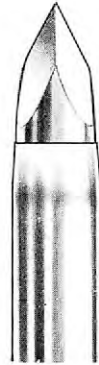
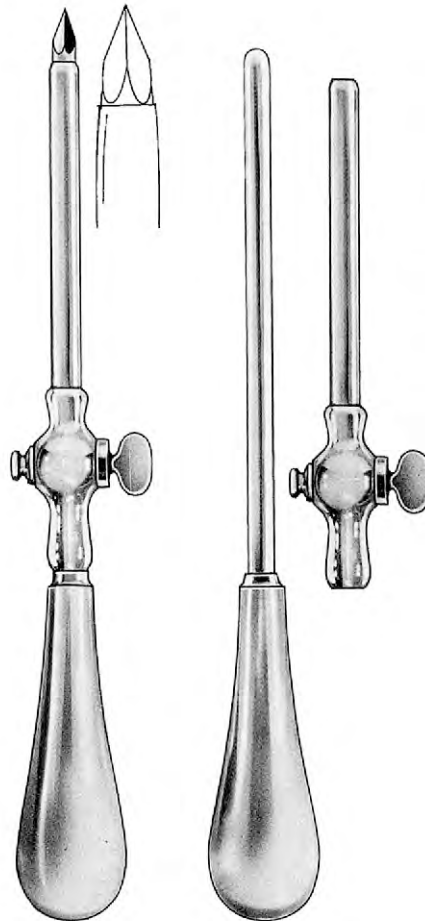


Fig. 3
 Ai 03-1249-03



Fig. 4
 Ai 03-1249-04



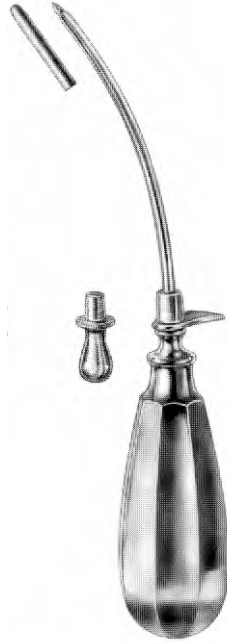
BUELAU
 Ai 03-1250-24
 24 cm/9 1/2"
 8.0 mm Ø



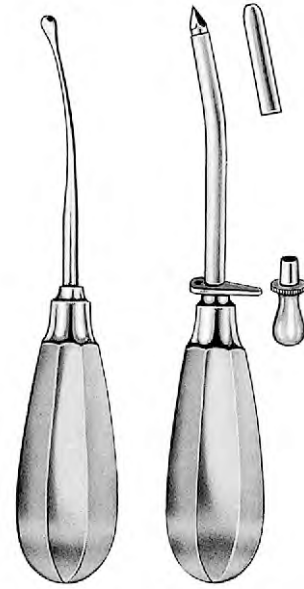
PEAN
 Ai 03-1251-13
 13.5mm Ø



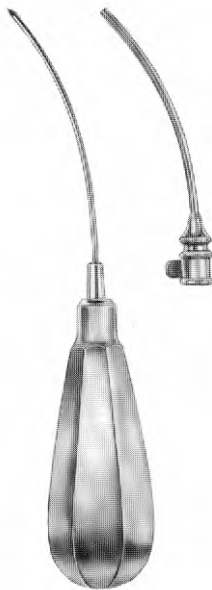
OCHSNER
 Ai 03-1252-04 4.0 mm Ø
 Ai 03-1252-05 5.5 mm Ø
 Ai 03-1252-06 6.5 mm Ø



PIERCE
 Ai 03-1253-03 15 cm/5 7/8" 3.0 mm Ø
 Ai 03-1253-04 15 cm/5 7/8" 4.0 mm Ø
 Ai 03-1253-05 15 cm/5 7/8" 5.0 mm Ø



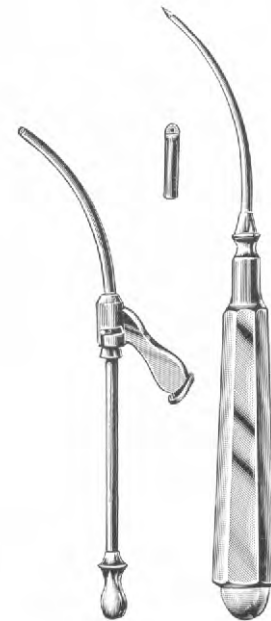
KRAUSE
 Ai 03-1254-15 15 cm/5 7/8"
 5.5 mm Ø



LICHTWITZ
 Ai 03-1255-02
 2.0 mm Ø



LICHTWITZ
 Ai 03-1256-19
 19 cm/7 1/2"
 1.8 mm Ø



COAKLEY
 Ai 03-1257-16
 16 cm/6 1/4"
 2.25 mm Ø

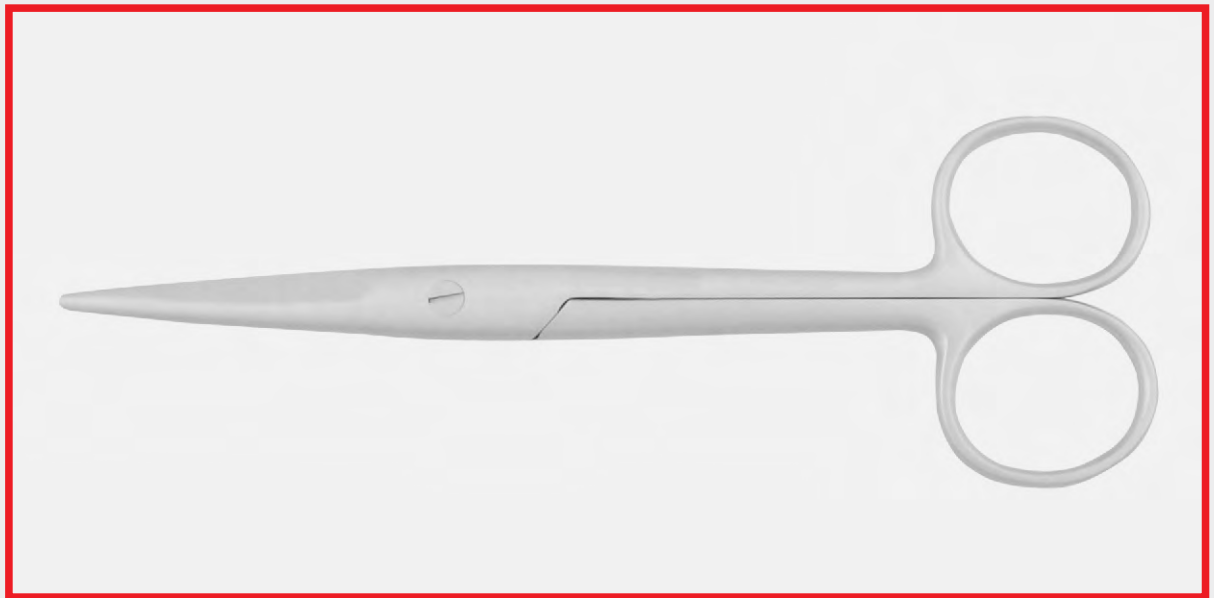


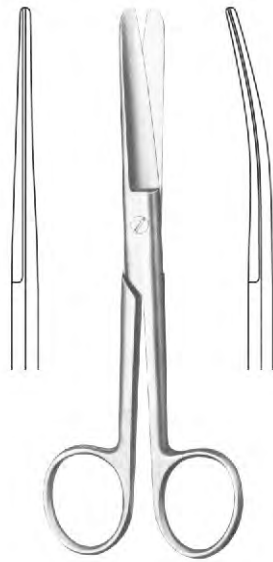
EN Scissors

DE Scheren

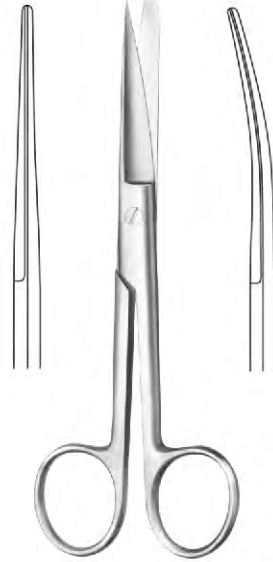
ES Tijeras

Page 38 to 64

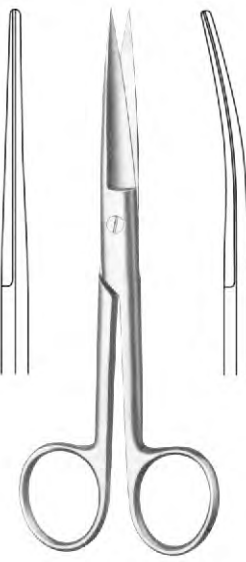




STANDARD
blunt/blunt

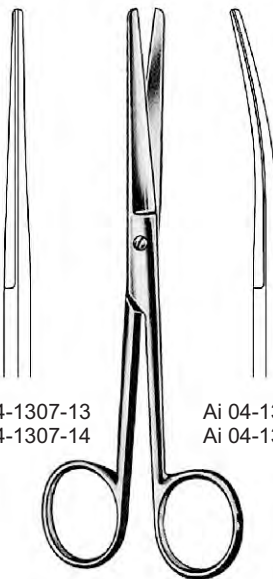


STANDARD
sharp/blunt

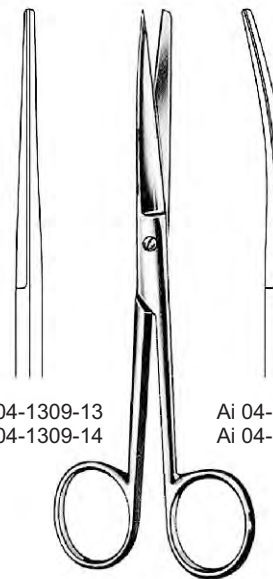


STANDARD
sharp/sharp

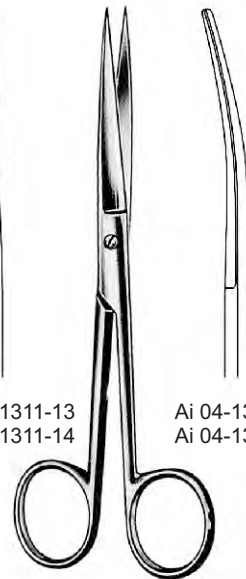
cm	in	Straight	Curved	Straight	Curved	Straight	Curved
10.5	4 1/8"	Ai 04-1301-10	Ai 04-1302-10	Ai 04-1303-10	Ai 04-1304-10	Ai 04-1305-10	Ai 04-1306-10
11.5	4 1/2"	Ai 04-1301-11	Ai 04-1302-11	Ai 04-1303-11	Ai 04-1304-11	Ai 04-1305-11	Ai 04-1306-11
13.0	5 1/8"	Ai 04-1301-13	Ai 04-1302-13	Ai 04-1303-13	Ai 04-1304-13	Ai 04-1305-13	Ai 04-1306-13
14.5	5 3/4"	Ai 04-1301-14	Ai 04-1302-14	Ai 04-1303-14	Ai 04-1304-14	Ai 04-1305-14	Ai 04-1306-14
15.5	6 1/8"	Ai 04-1301-15	Ai 04-1302-15	Ai 04-1303-15	Ai 04-1304-15	Ai 04-1305-15	Ai 04-1306-15
16.5	6 1/2"	Ai 04-1301-16	Ai 04-1302-16	Ai 04-1303-16	Ai 04-1304-16	Ai 04-1305-16	Ai 04-1306-16
17.5	6 7/8"	Ai 04-1301-17	Ai 04-1302-17	Ai 04-1303-17	Ai 04-1304-17	Ai 04-1305-17	Ai 04-1306-17
18.5	7 1/4"	Ai 04-1301-18	Ai 04-1302-18	Ai 04-1303-18	Ai 04-1304-18	Ai 04-1305-18	Ai 04-1306-18
20.0	7 7/8"	Ai 04-1301-20	Ai 04-1302-20	Ai 04-1303-20	Ai 04-1304-20	Ai 04-1305-20	Ai 04-1306-20



GRAZIL
blunt/blunt

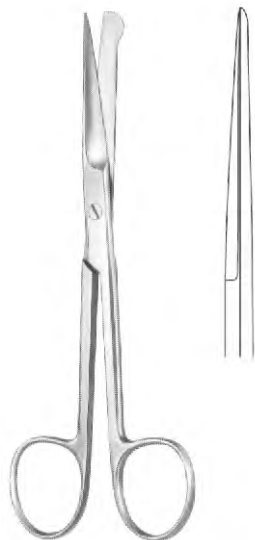


GRAZIL
sharp/blunt

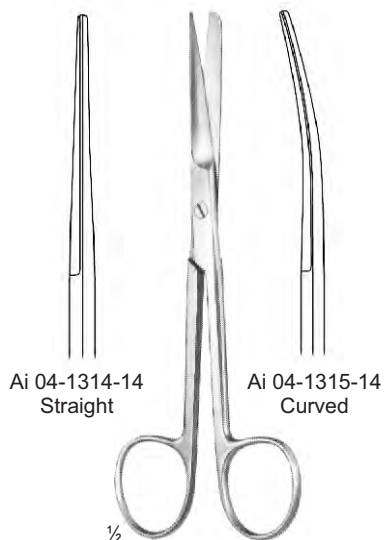


GRAZIL
sharp/sharp

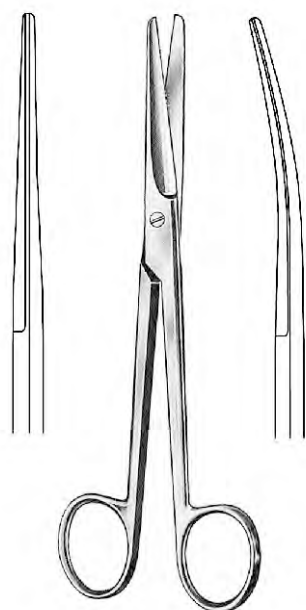
cm	in	Straight	Curved	Straight	Curved	Straight	Curved
13.0	5 1/8"	Ai 04-1307-13	Ai 04-1308-13	Ai 04-1309-13	Ai 04-1310-13	Ai 04-1311-13	Ai 04-1312-13
14.5	5 3/4"	Ai 04-1307-14	Ai 04-1308-14	Ai 04-1309-14	Ai 04-1310-14	Ai 04-1311-14	Ai 04-1312-14



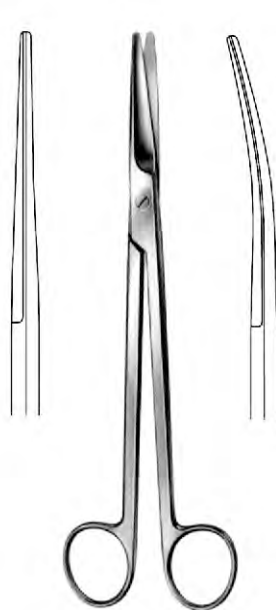
INCISION
 Ai 04-1313-13 13 cm/5 1/8"
 Ai 04-1313-14 14.5 cm/5 3/4"



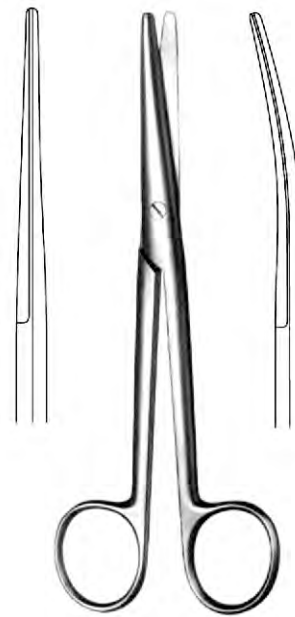
Ai 04-1314-14 Straight
 Ai 04-1315-14 Curved
 1/2
DEAVER
 14 cm/5 1/2"



MAYO
 straight
 Ai 04-1316-14 14.5 cm/5 3/4"
 Ai 04-1316-15 15 cm/5 7/8"
 Ai 04-1316-17 17 cm/6 3/4"
 Ai 04-1316-23 23 cm/9"
 curved
 Ai 04-1317-14
 Ai 04-1317-15
 Ai 04-1317-17
 Ai 04-1317-23



MAYO-HARRINGTON
 straight
 Ai 04-1318-23 23 cm/9"
 Ai 04-1318-28 28 cm/11"
 curved
 Ai 04-1319-23
 Ai 04-1319-28

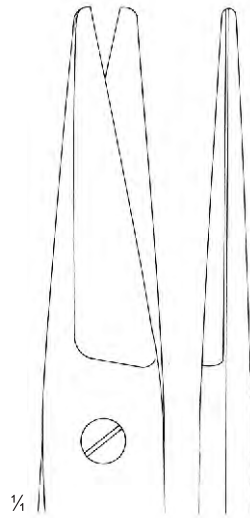


MAYO-STILLE
 straight
 Ai 04-1320-15 15 cm/5 7/8"
 Ai 04-1320-16 16.5 cm/6 1/2"
 Ai 04-1320-17 17 cm/6 3/4"
 Ai 04-1320-19 19.5 cm/7 1/2"
 Ai 04-1320-21 21 cm/8 1/4"
 curved
 Ai 04-1321-15
 Ai 04-1321-16
 Ai 04-1321-17
 Ai 04-1321-19
 Ai 04-1321-21

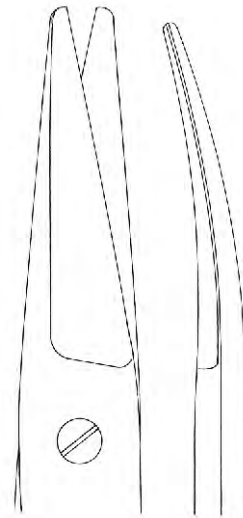




MAYO-NOBLE
16.5 cm/6 1/2"



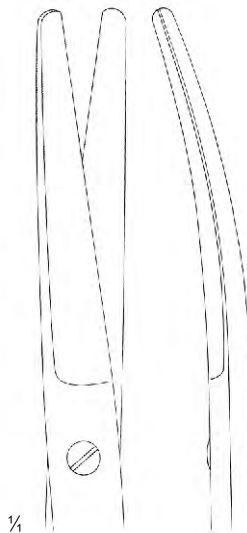
Ai 04-1322-16
straight



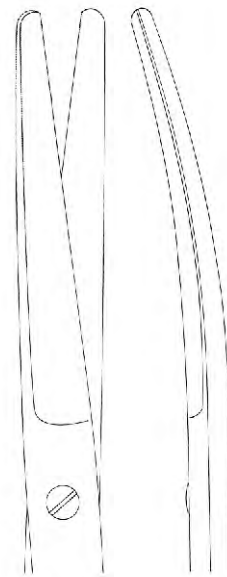
Ai 04-1323-16
curved



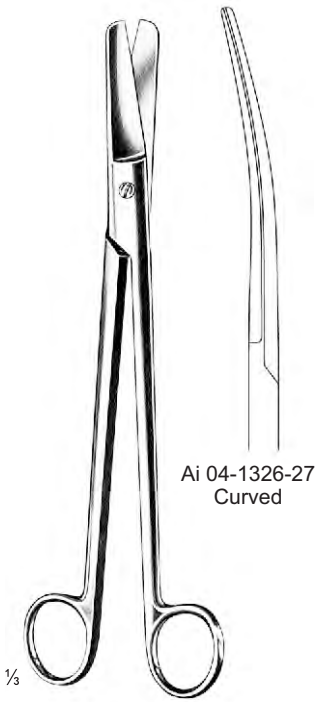
WERTHEIM



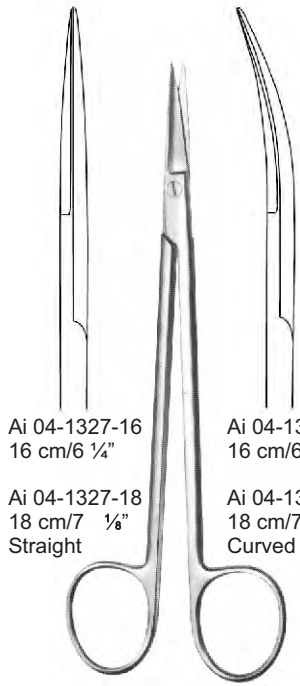
Ai 04-1324-20
20 cm/7 7/8"



Ai 04-1324-23
23 cm/9"



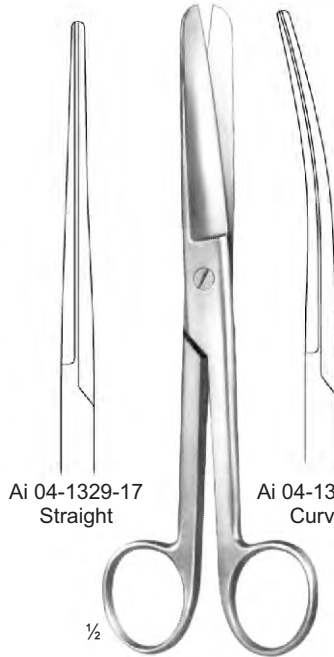
DUBOIS
 Ai 04-1325-27
 27 cm/10 1/2"
 Straight



KELLY

Ai 04-1327-16
 16 cm/6 1/4"
 Ai 04-1327-18
 18 cm/7 1/8"
 Straight

Ai 04-1328-16
 16 cm/6 1/4"
 Ai 04-1328-18
 18 cm/7 1/8"
 Curved



DOYEN
 17.5 cm/6 7/8"

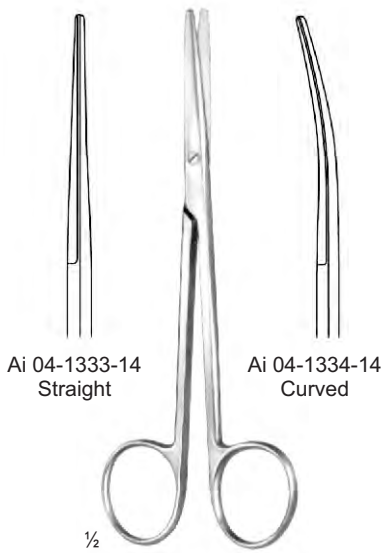
Ai 04-1329-17
 Straight

Ai 04-1330-17
 Curved



METZENBAUM BABY
 Ai 04-1331-11
 11.5 cm/4 1/2"
 Straight

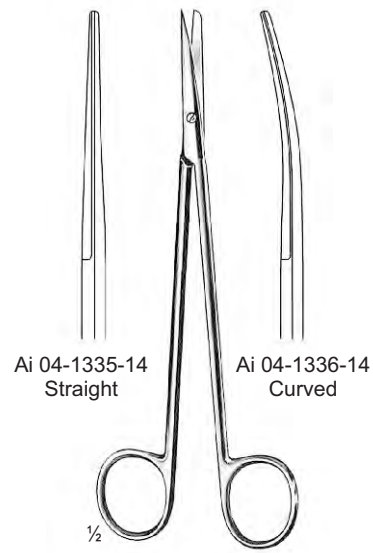
Ai 04-1332-11
 Curved



METZENBAUM
 14.5 cm/5 3/4"
 blunt/blunt

Ai 04-1333-14
 Straight

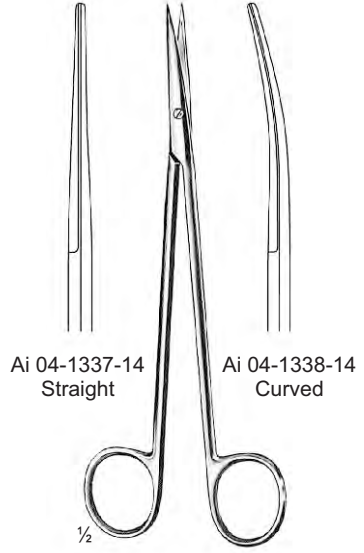
Ai 04-1334-14
 Curved



METZENBAUM
 14.5 cm/5 3/4"
 sharp/blunt

Ai 04-1335-14
 Straight

Ai 04-1336-14
 Curved

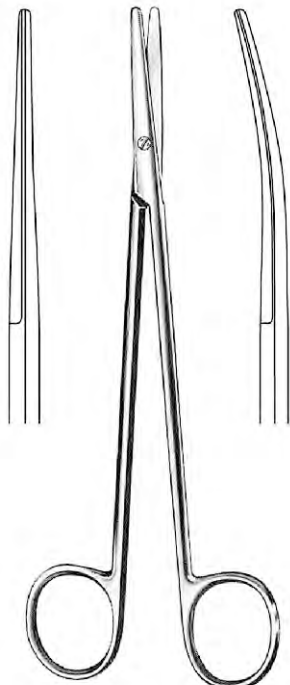


METZENBAUM
 14.5 cm/5 3/4"
 sharp/sharp

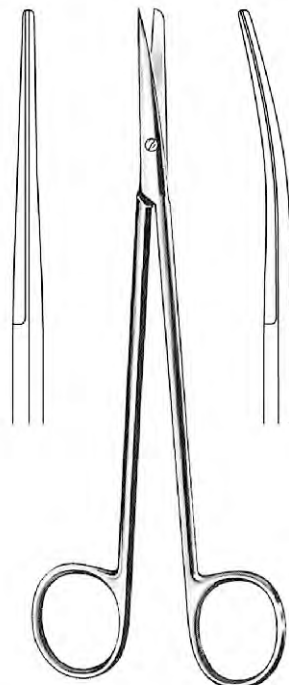
Ai 04-1337-14
 Straight

Ai 04-1338-14
 Curved

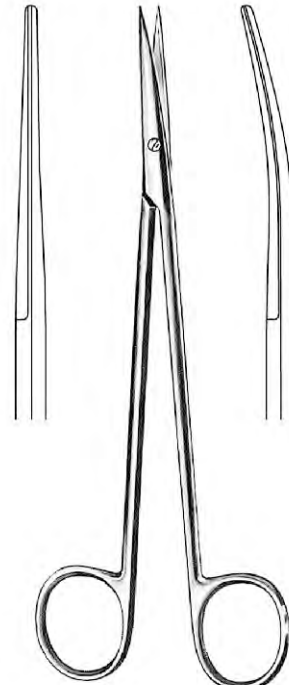




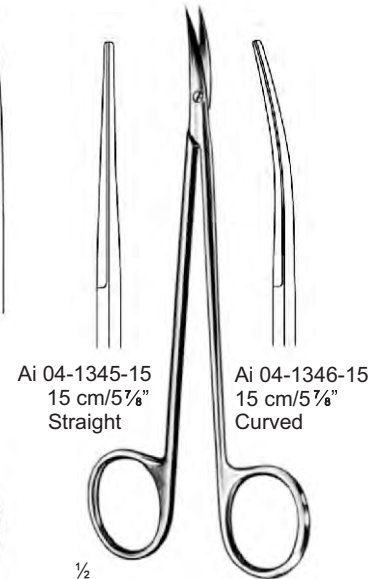
METZENBAUM-NELSON
blunt/blunt



METZENBAUM-NELSON
sharp/blunt



METZENBAUM-NELSON
sharp/sharp

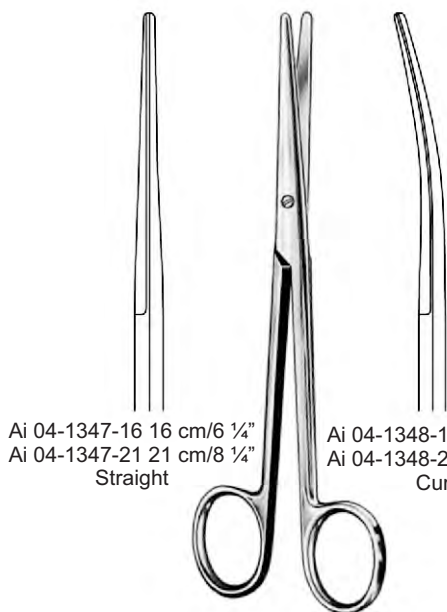


Ai 04-1345-15
15 cm/5 7/8"
Straight

Ai 04-1346-15
15 cm/5 7/8"
Curved

**NERVE DISSECTING
SCISSORS**

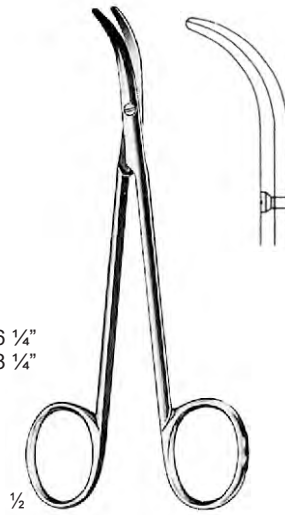
cm	in	straight	curved	straight	curved	straight	curved
18	7 1/8"	Ai 04-1339-18	Ai 04-1340-18	Ai 04-1341-18	Ai 04-1342-18	Ai 04-1343-18	Ai 04-1344-18
20	7 7/8"	Ai 04-1339-20	Ai 04-1340-20	Ai 04-1341-20	Ai 04-1342-20	Ai 04-1343-20	Ai 04-1344-20
23	9"	Ai 04-1339-23	Ai 04-1340-23	Ai 04-1341-23	Ai 04-1342-23	Ai 04-1343-23	Ai 04-1344-23
25	9 7/8"	Ai 04-1339-25	Ai 04-1340-25	Ai 04-1341-25	Ai 04-1342-25	Ai 04-1343-25	Ai 04-1344-25
28	11"	Ai 04-1339-28	Ai 04-1340-28	Ai 04-1341-28	Ai 04-1342-28	Ai 04-1343-28	Ai 04-1344-28
30	11 3/4"	Ai 04-1339-30	Ai 04-1340-30	Ai 04-1341-30	Ai 04-1342-30	Ai 04-1343-30	Ai 04-1344-30



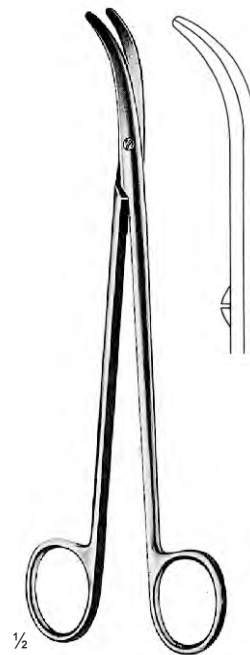
Ai 04-1347-16 16 cm/6 1/4"
Ai 04-1347-21 21 cm/8 1/4"
Straight

Ai 04-1348-16 16 cm/6 1/4"
Ai 04-1348-21 21 cm/8 1/4"
Curved

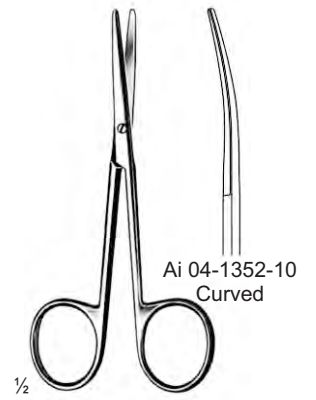
LEXER



FOMON
Ai 04-1349-13
13.5 cm/5 3/8"



THOREK
Ai 04-1350-19
19 cm/7 1/2"

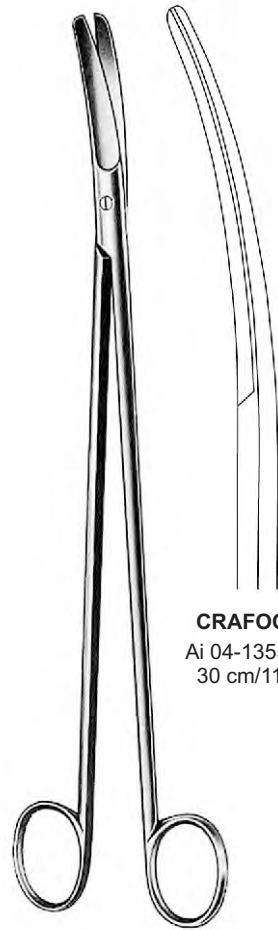


LEXER-BABY
Ai 04-1351-10
10 cm/3 7/8"
Straight



Ai 04-1354-12 12 cm/4 3/4"
 Ai 04-1354-15 15 cm/5 7/8"

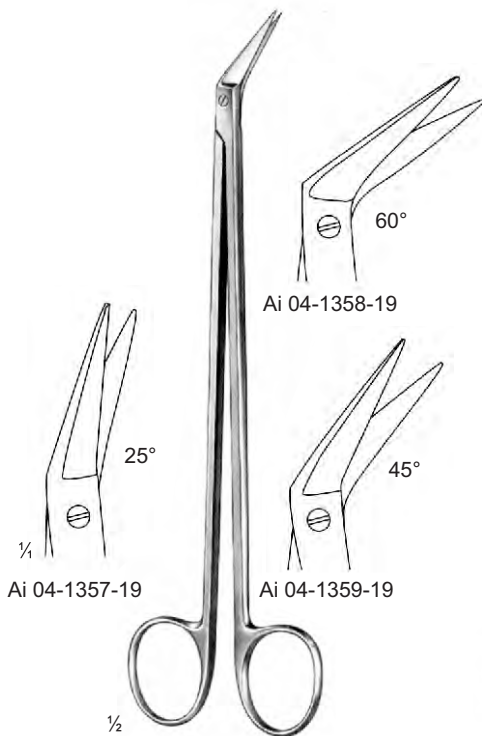
KILNER
 Ai 04-1353-13
 13 cm/5 1/4"



CRAFOORD
 Ai 04-1355-30
 30 cm/11 3/4"



SATINSKY
 Ai 04-1356-24
 24.5 cm/9 5/8"



1/4
 Ai 04-1357-19

60°
 Ai 04-1358-19

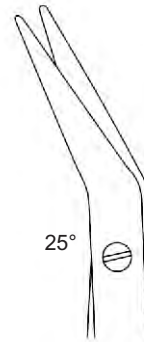
45°
 Ai 04-1359-19

1/2

POTTS-SMITH
 19 cm/7 1/2"

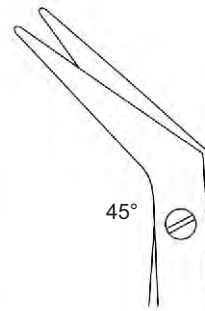


DEBAKEY



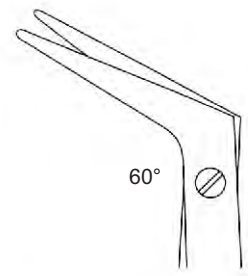
25°

16 cm/6 1/4"
 23 cm/9"
 28 cm/11"
 Ai 04-1360-16
 Ai 04-1360-23
 Ai 04-1360-28



45°

Ai 04-1361-16
 Ai 04-1361-23
 Ai 04-1361-28



60°

Ai 04-1362-16
 Ai 04-1362-23
 Ai 04-1362-28



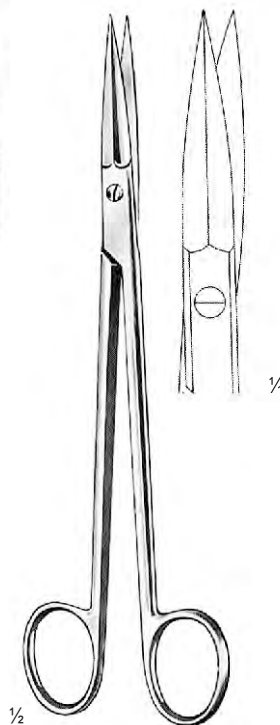


JOSEPH
 Ai 04-1363-14
 14 cm/5 1/2"
 Straight

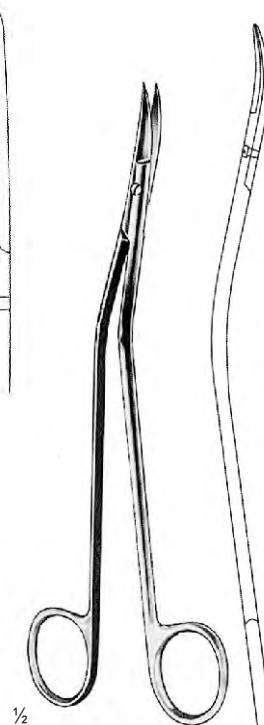
Ai 04-1364-14
 Curved



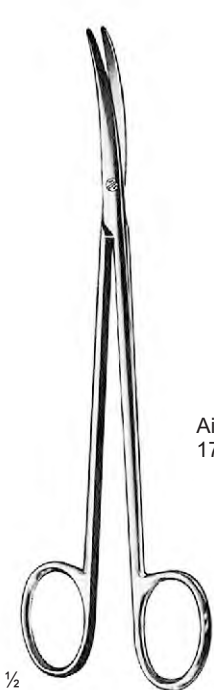
STRULLY
 Ai 04-1365-22
 22 cm/8 1/2"



MCINDOE
 Ai 04-1366-19
 19 cm/7 1/2"

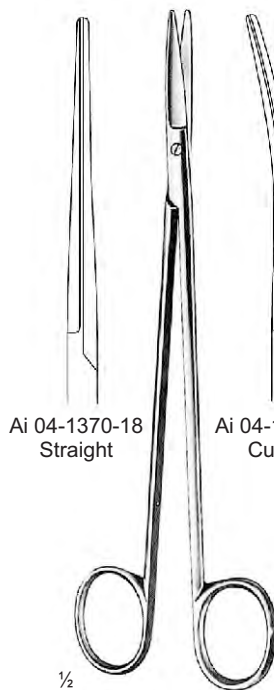


DANDY
 Ai 04-1367-17
 17 cm/6 3/4"



TOENNIS-ADSON
 Ai 04-1368-17
 17.5 cm/6 7/8"
 Curved

Ai 04-1369-17
 17.5 cm/6 7/8"
 Straight

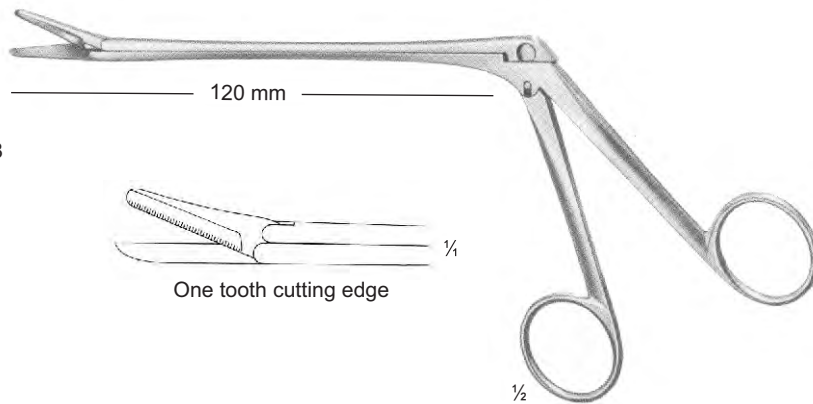


TOENNIS
 18 cm/7 1/8"

Ai 04-1370-18
 Straight

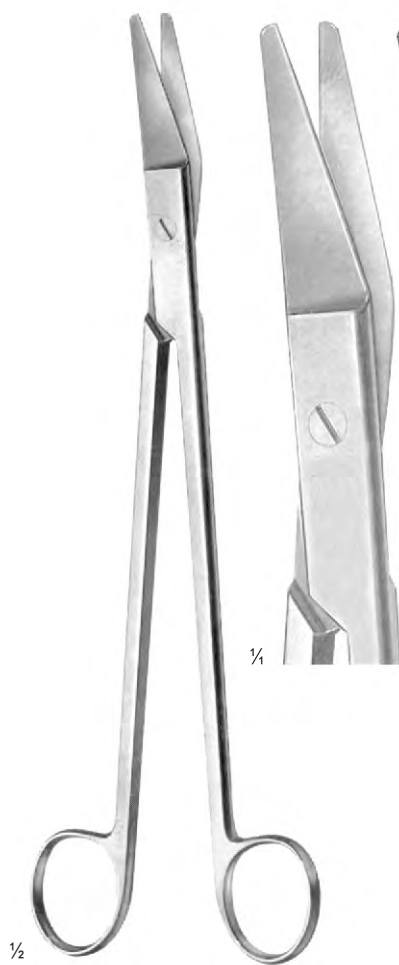


Ai 04-1371-18
 Curved

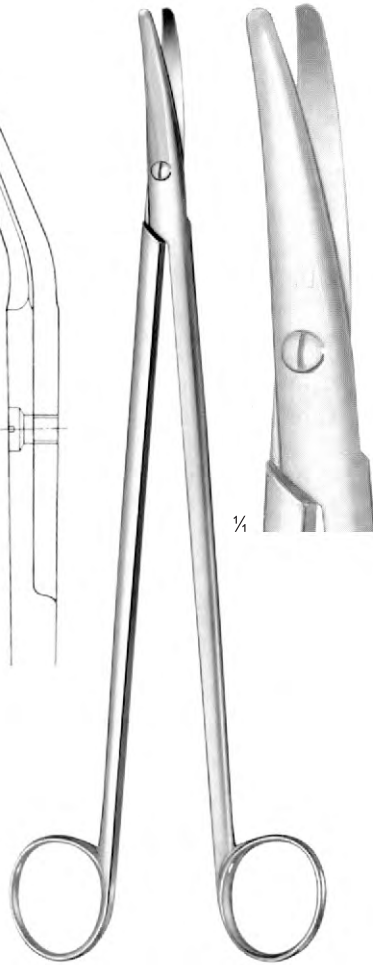


OLIVECRONA
 Trigeminal Scissors
 Ai 04-1372-23
 23 cm/9"

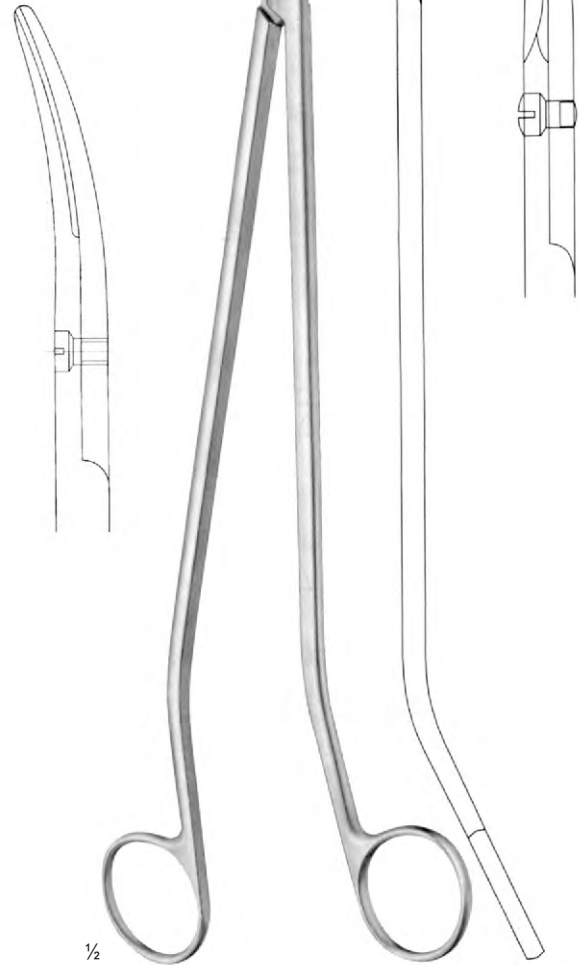
One tooth cutting edge



$\frac{1}{2}$
RESANO
 Ai 04-1373-25
 25 cm/9 $\frac{7}{8}$ "
 Cartilage scissors

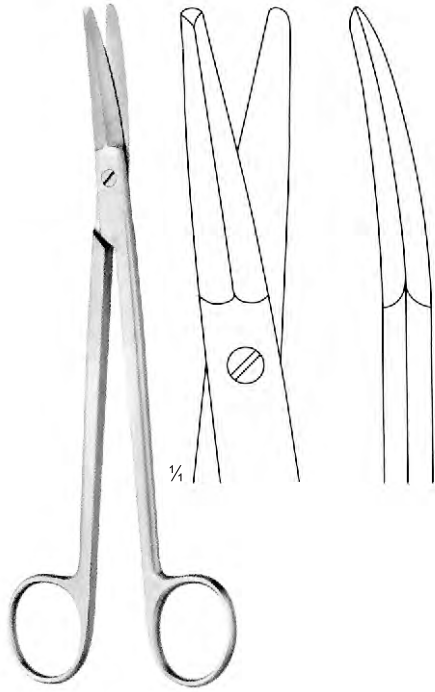


$\frac{1}{4}$
WELLER
 Ai 04-1374-28
 28 cm/11"
 Dissecting scissors
 heavy pattern

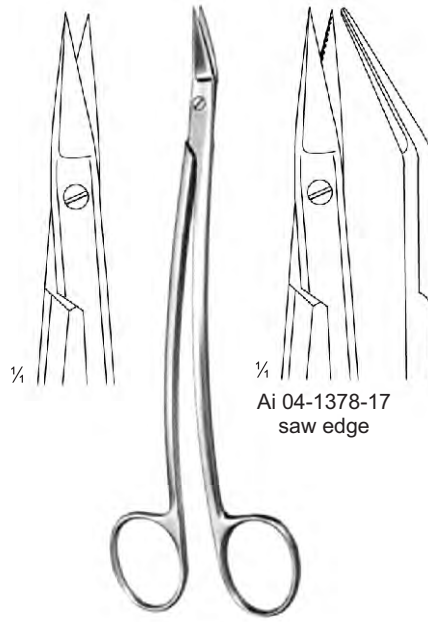


$\frac{1}{2}$
MULLER
 Ai 04-1375-32
 32.5 cm/12 $\frac{3}{4}$ "

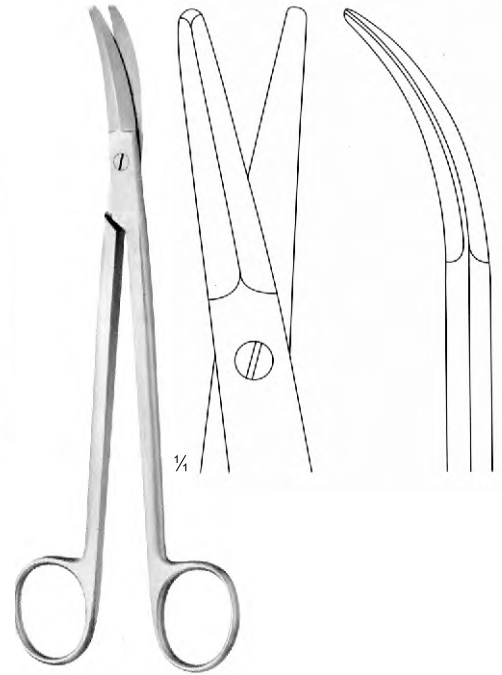




BOETTCHER
 Ai 04-1376-18
 18 cm/7 1/8"



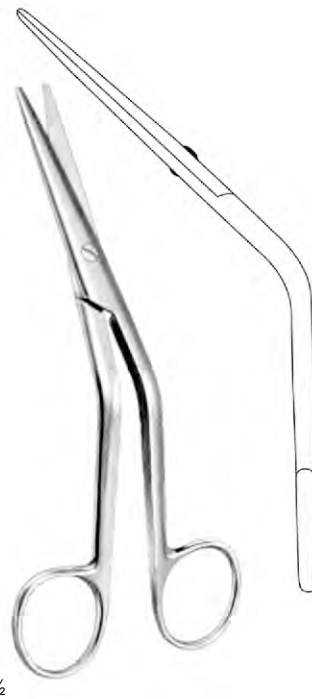
DEAN
 Ai 04-1377-17
 17 cm/6 3/4"



PRINCE
 Ai 04-1379-17
 17.5 cm/6 7/8"



HEYMANN
 Ai 04-1380-18
 18 cm/7 1/8"



COTTLE
 Ai 04-1381-16
 16 cm/6 1/4"

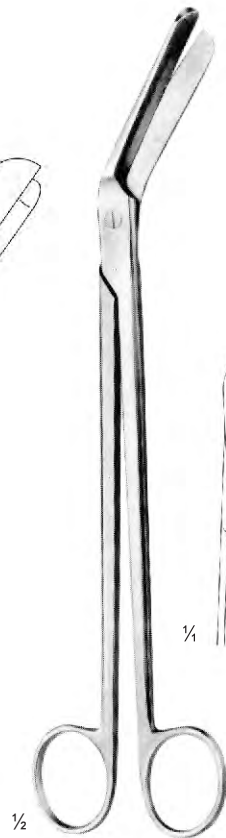


FOMON
 Ai 04-1382-15
 15 cm/5 7/8"





BRAUN-STADLER
 Ai 04-1383-14
 14.5 cm/5 3/4"

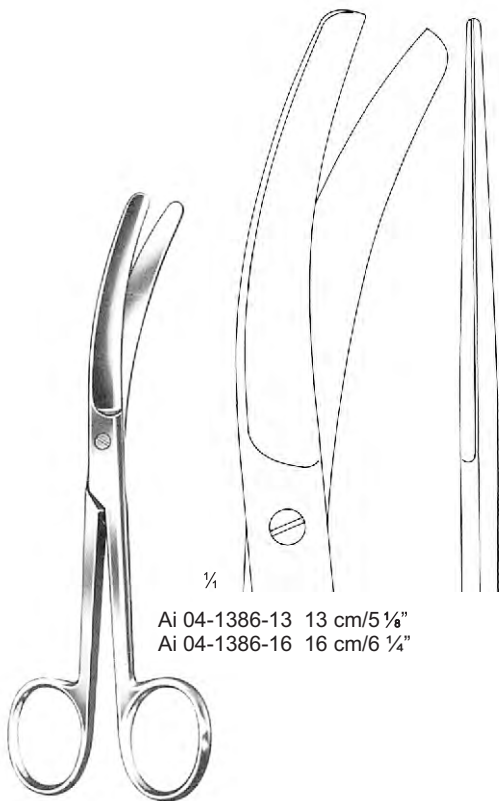


BRAUN-STADLER
 Ai 04-1384-22
 22 cm/8 1/2"



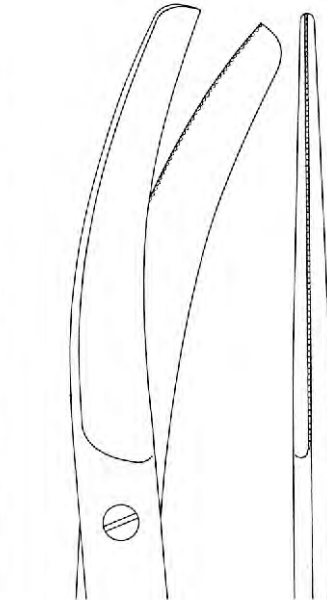
Ai 04-1385-24
 Episiotomy Scissors
 24 cm/9 1/2"

One toothed cutting edge

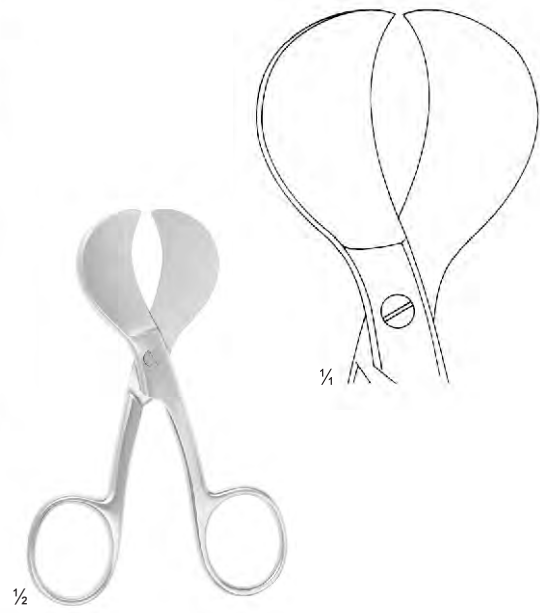


Ai 04-1386-13 13 cm/5 1/8"
 Ai 04-1386-16 16 cm/6 1/4"

BUSCH

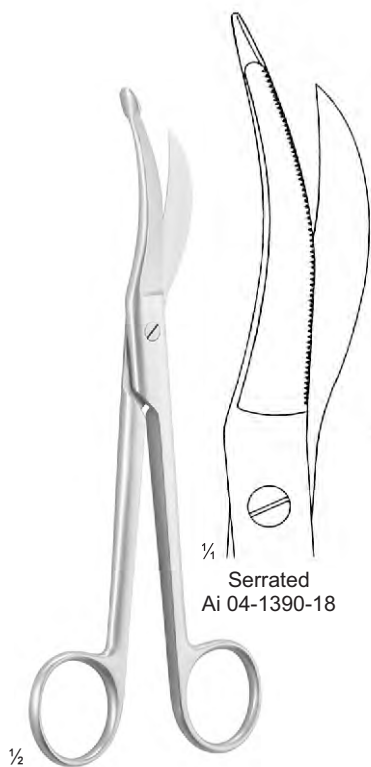


Ai 04-1387-13 13 cm/5 1/8"
 Ai 04-1387-16 16 cm/6 1/4"
 One tooth cutting edge



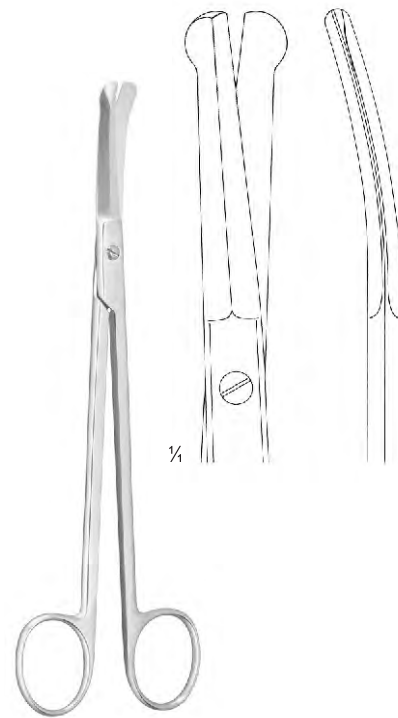
MOD. USA
 Ai 04-1388-10
 10.5 cm/4 1/8"





Serrated
 Ai 04-1390-18

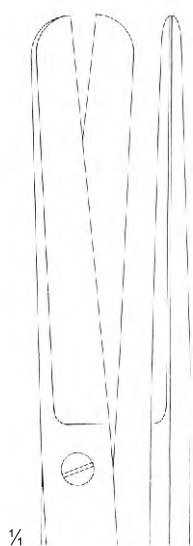
WALDMANN
 Ai 04-1389-18
 18 cm/7 1/8"
 Non-Serrated



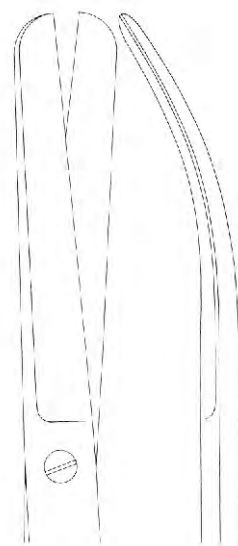
GOOD
 Ai 04-1391-19
 19 cm/7 1/2"



SIMS



Ai 04-1392-20
 20 cm/7 7/8"
 straight



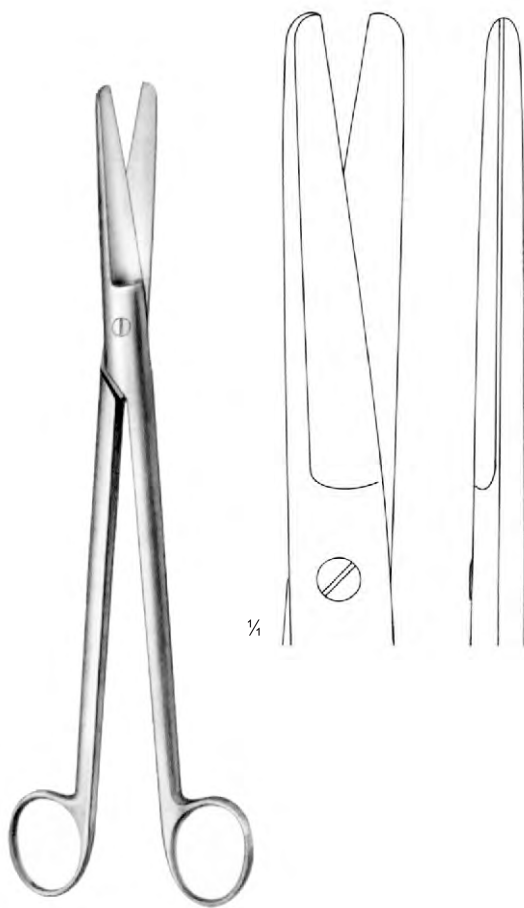
Ai 04-1393-20
 20 cm/7 7/8"
 curved



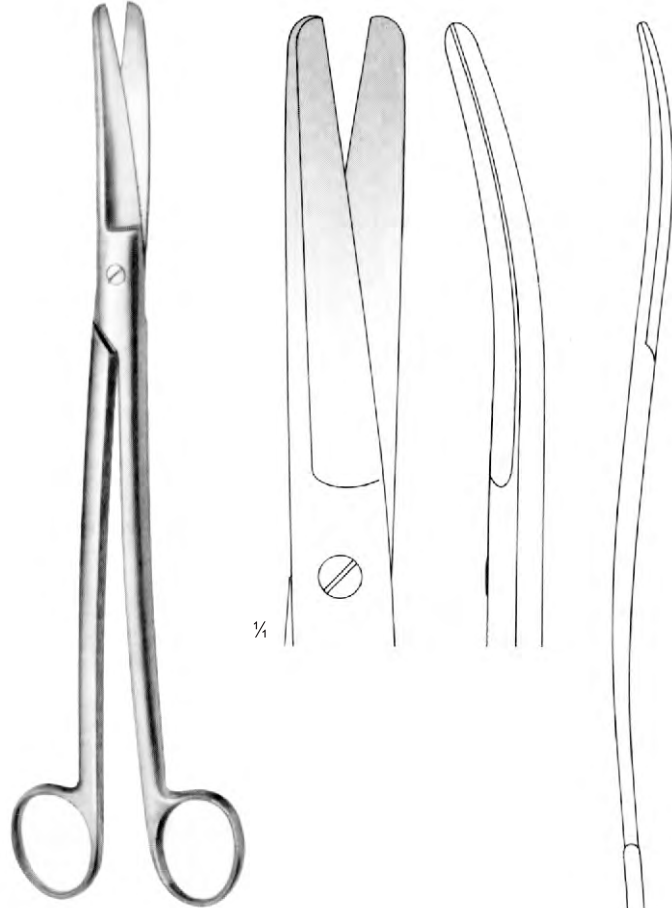
Ai 04-1394-23 23 cm/9"
 Ai 04-1394-25 25 cm/9 7/8"
 Straight



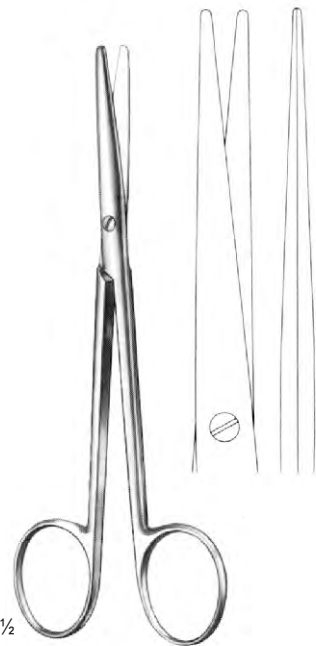
Ai 04-1395-23
 23 cm/9"
 curved



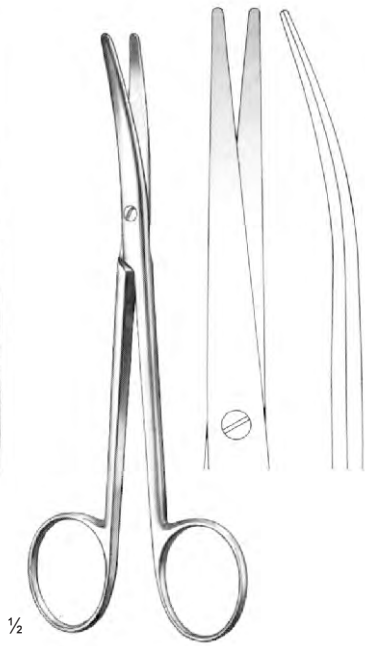
SIMS-SIEBOLD
 straight
 Ai 04-1396-24
 24 cm/9 1/2"



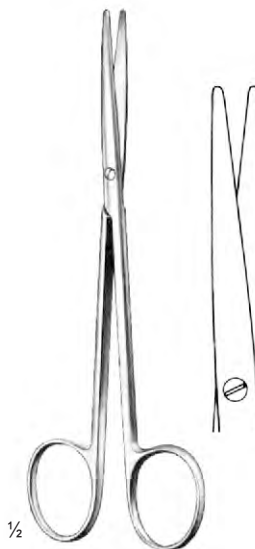
SIMS-SIEBOLD
 S-Shaped
 Ai 04-1397-24
 24 cm/9 1/2"



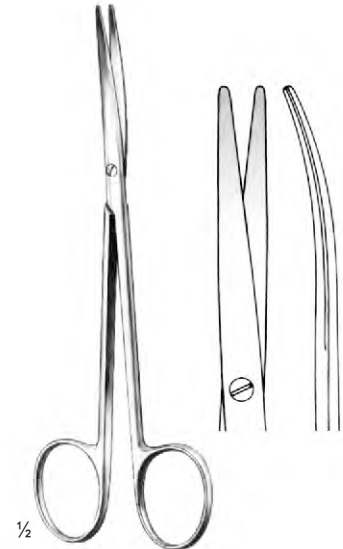
LEXER-FINO
 Ai 04-1398-16
 16 cm/6 1/4"
 Straight



LEXER-FINO
 Ai 04-1399-16
 16 cm/6 1/4"
 Curved

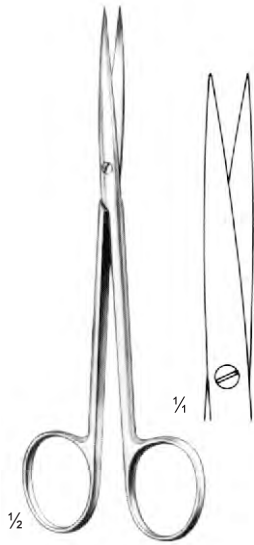


METZENBAUM-FINO
 Ai 04-1400-14
 14.5 cm/5 3/4"
 Straight
 Blunt/Blunt

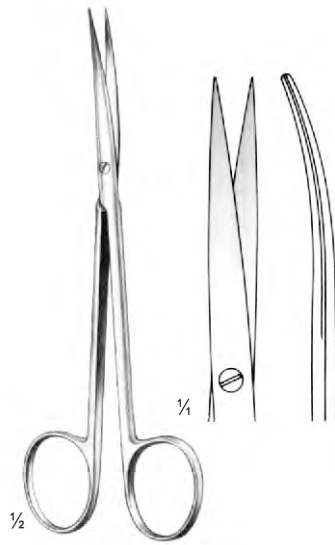


METZENBAUM-FINO
 Ai 04-1401-14
 14.5 cm/5 3/4"
 Curved
 Blunt/Blunt

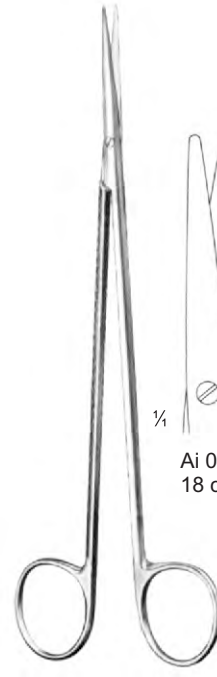




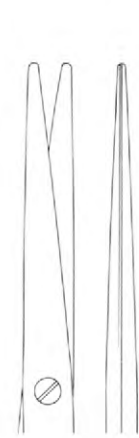
METZENBAUM-FINO
 Ai 04-1402-14
 14.5 cm/5 3/4"
 Straight
 Sharp/Sharp



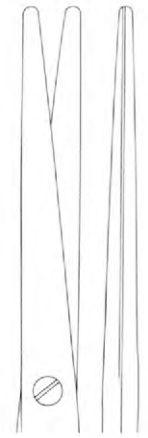
METZENBAUM-FINO
 Ai 04-1403-14
 14.5 cm/5 3/4"
 Curved
 Sharp/Sharp



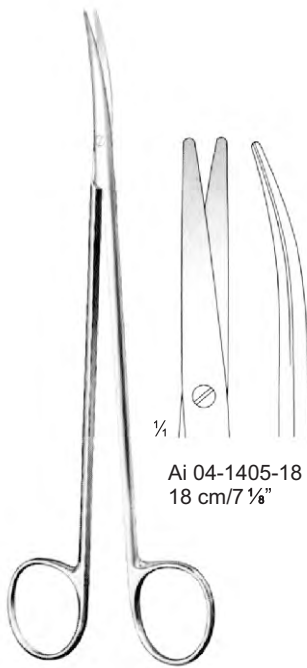
1/4
 Ai 04-1404-18
 18 cm/7 1/8"



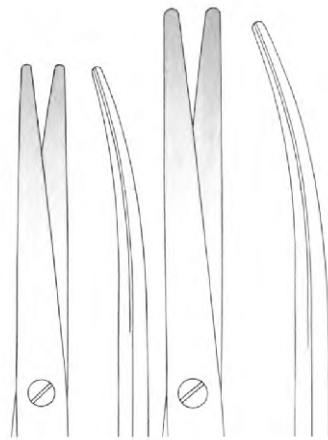
1/4
 Ai 04-1404-20
 20 cm/7 7/8"



1/4
 Ai 04-1404-23
 23 cm/9"



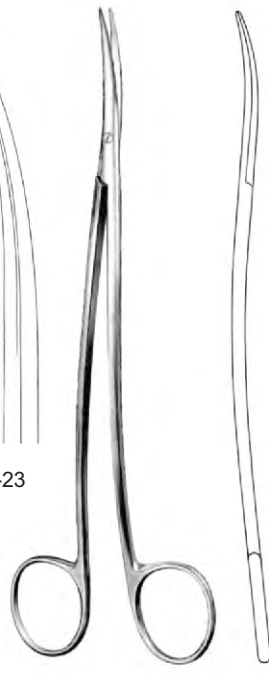
1/4
 Ai 04-1405-18
 18 cm/7 1/8"



1/4
 Ai 04-1405-20
 20 cm/7 7/8"



1/4
 Ai 04-1405-23
 23 cm/9"



METZENBAUM-FINO
 S-SHAPED



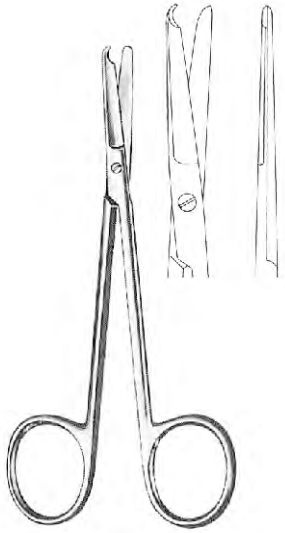
1/4
 Ai 04-1406-18
 18 cm/7 1/8"



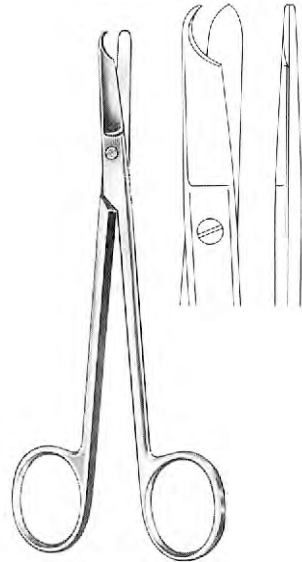
1/4
 Ai 04-1406-20
 20 cm/7 7/8"



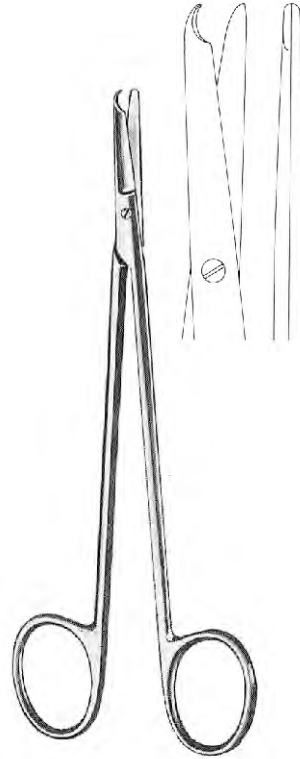
1/4
 Ai 04-1406-23
 23 cm/9"



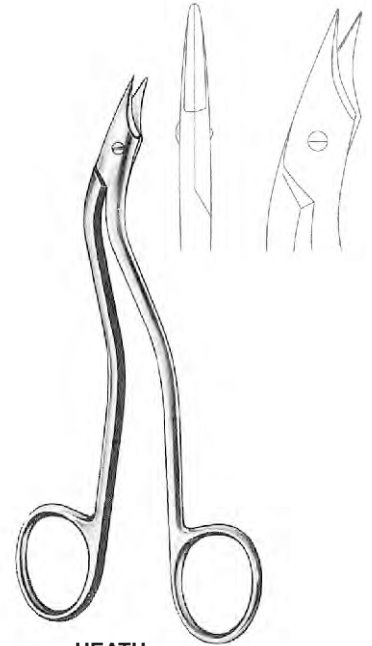
SPENCER
 Ai 04-1407-09 9 cm/3 1/2"
 Ai 04-1407-10 10.5 cm/4 1/8"
 Ai 04-1407-13 13 cm/5 1/8"



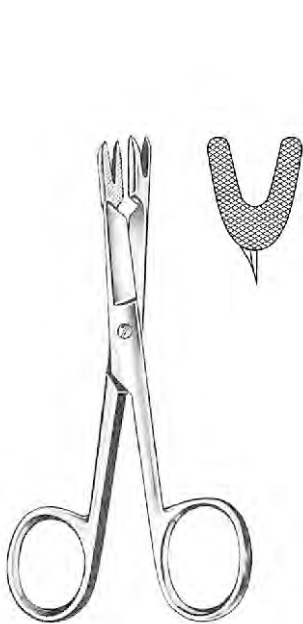
LITTAUER
 Ai 04-1408-14
 14 cm/5 1/2"



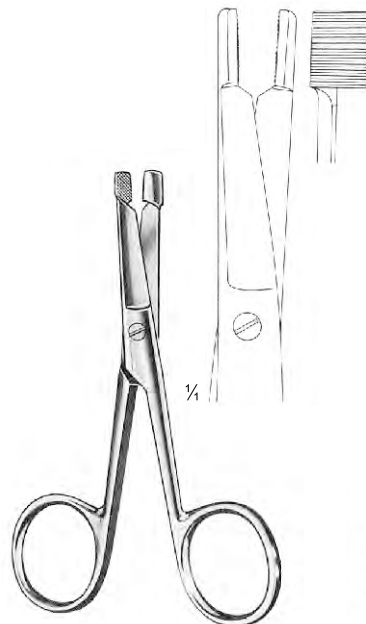
BUCK
 Ai 04-1409-14
 14.5 cm/5 3/4"



HEATH
 Ai 04-1410-15
 15 cm/5 7/8"



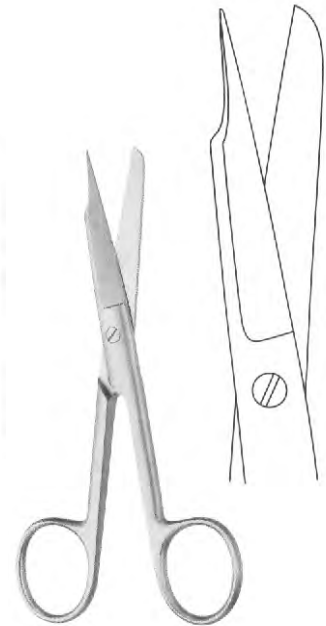
SCHOEMAKER-LOTH
 Ai 04-1411-13
 13 cm/5 1/8"



EISELSBERG
 Ai 04-1412-12
 12 cm/4 3/4"

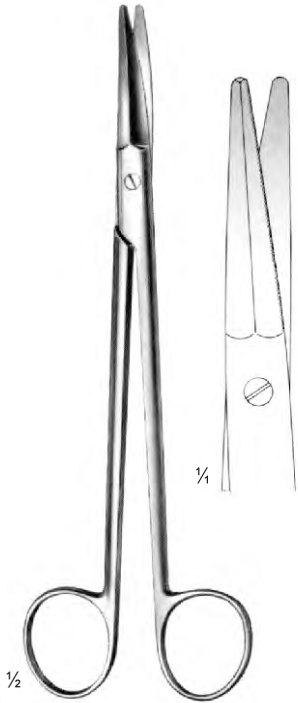


NORTHBENT
 Ai 04-1413-09 9 cm/3 1/2"
 Ai 04-1413-12 12.5 cm/4 7/8"

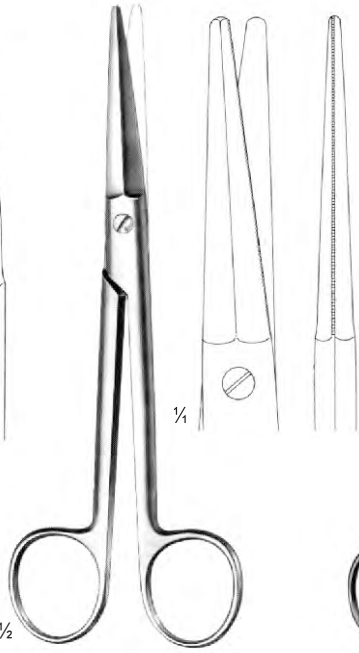


NAIL SPLITTING SCISSORS
 Ai 04-1414-13 13 cm/5 1/8"
 Ai 04-1414-15 15 cm/5 7/8"

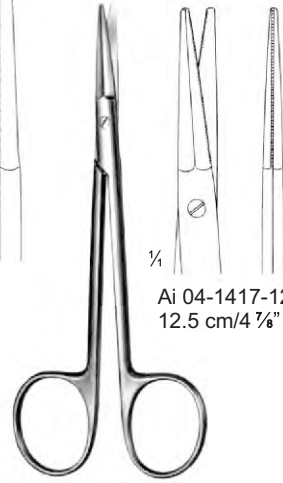




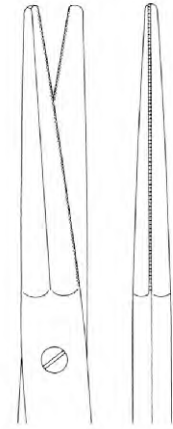
KAYE (TOOTHED)
 Ai 04-1415-18
 18.5 cm/7 1/4"



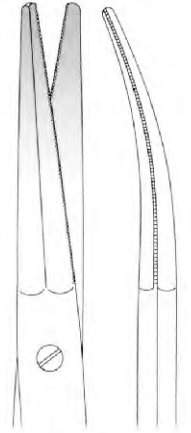
ASTON (TOOTHED)
 Ai 04-1416-17
 17 cm/6 3/4"



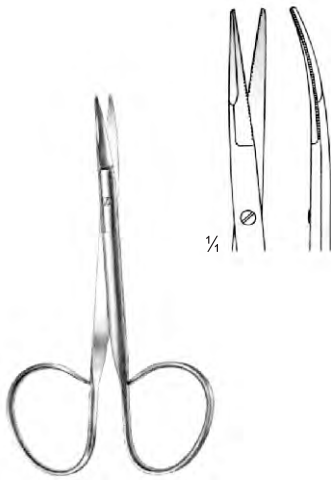
Ai 04-1417-12
 12.5 cm/4 7/8"



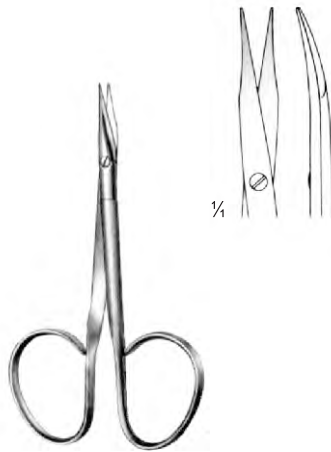
Ai 04-1417-19
 19.5 cm/7 1/2"



Ai 04-1418-19
 19.5 cm/7 1/2"



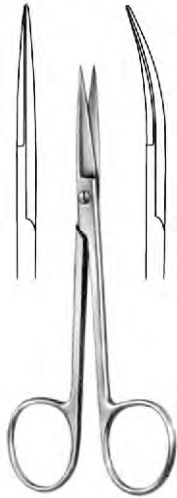
KAYE
 Ai 04-1419-11
 11 cm/4 3/8"



SALYER
 Ai 04-1420-10
 10 cm/3 7/8"



SALYER
 Ai 04-1421-09
 9.5 cm/3 3/8"



IRIS

9 cm/3 1/2"	Straight	Curved
10.5 cm/4 1/8"	Ai 04-1422-09	Ai 04-1423-09
11.5 cm/4 1/2"	Ai 04-1422-10	Ai 04-1423-10
	Ai 04-1422-11	Ai 04-1423-11



IRIS-FINE

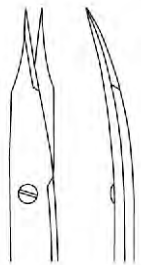
Ai 04-1424-11
 11.5 cm/4 1/2"



IRIS-FINE

Ai 04-1425-11
 11.5 cm/4 1/2"
 angled

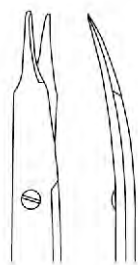
Pointed



curved
 Ai 04-1427-11

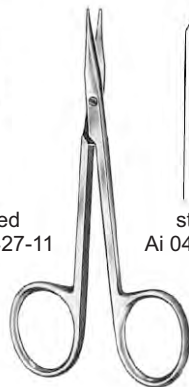
straight
 Ai 04-1426-11

Blunt

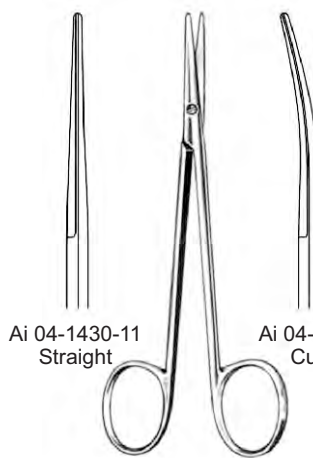


straight
 Ai 04-1428-11

curved
 Ai 04-1429-11



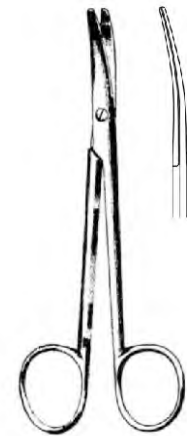
STEVENS-TENOTOMY
 11.5 cm/4 1/2"



Ai 04-1430-11
 Straight

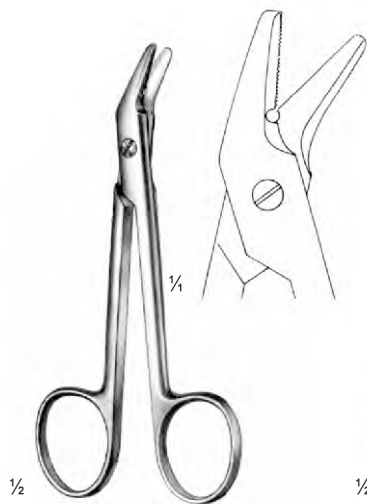
Ai 04-1431-11
 Curved

STRABISMUS
 11.5 cm/4 1/2"

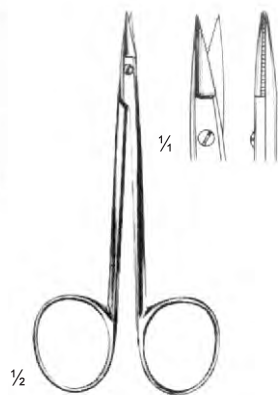


ENUCLEATION
 Ai 04-1432-11
 11 cm/4 3/8"





UNIVERSAL
 Ai 04-1433-12
 12 cm/4 3/4"
 one saw edge



Ai 04-1434-10
 10 cm/3 7/8"
 saw edge



BEEBEE
 10.5 cm/4 1/8"



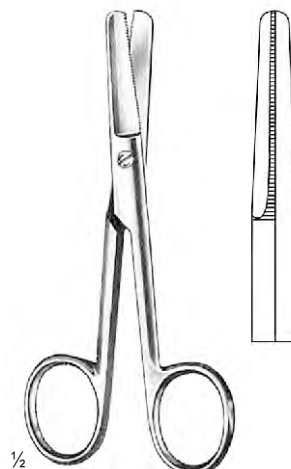
Ai 04-1441-12
 12 cm/4 3/4"
 saw edge



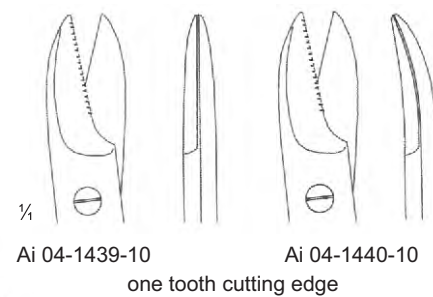
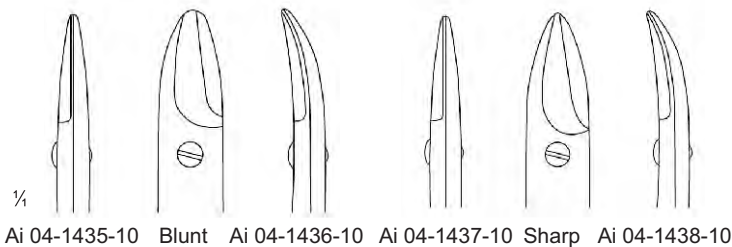
Ai 04-1442-10
 10.5 cm/4 1/8"
 saw edge



Ai 04-1443-15
 15.5 cm/6 1/8"
 saw edge



HARVEY
 Ai 04-1444-12
 12.5 cm/4 7/8"





12 cm/4 3/4"



Ai 04-1445-12
 Straight
 Sharp/Blunt



Ai 04-1446-12
 Straight
 Sharp/Sharp

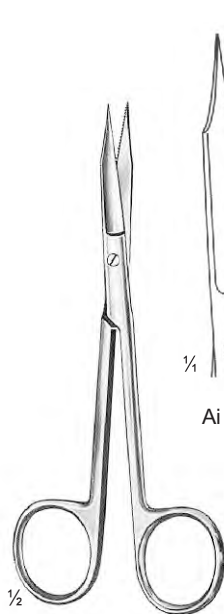


Ai 04-1447-12
 Curved
 Sharp/Blunt



Ai 04-1448-12
 Curved
 Sharp/Sharp

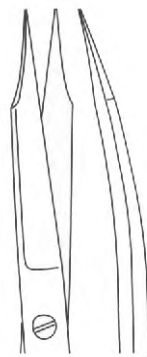
Fine Scissors



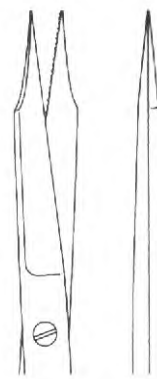
GOLDMANN-FOX
 13 cm/5 1/4"



Ai 04-1449-13
 Straight



Ai 04-1450-13
 Curved



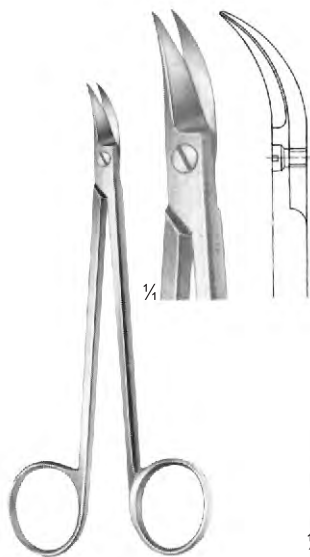
Ai 04-1451-13
 Straight



Ai 04-1452-13
 Curved

Toothed Blades

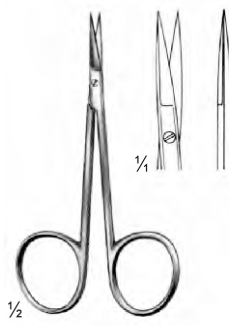




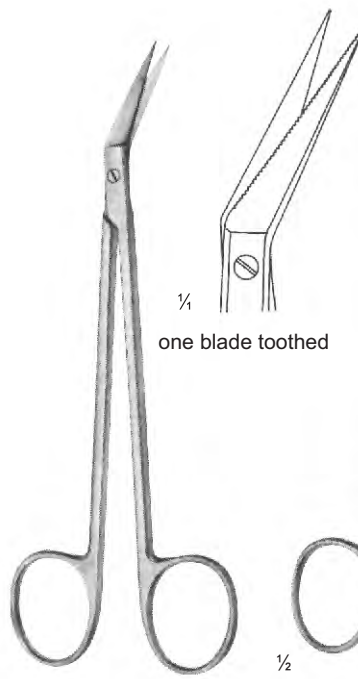
QUINBY
 Ai 04-1453-12
 12.5 cm/4 7/8"



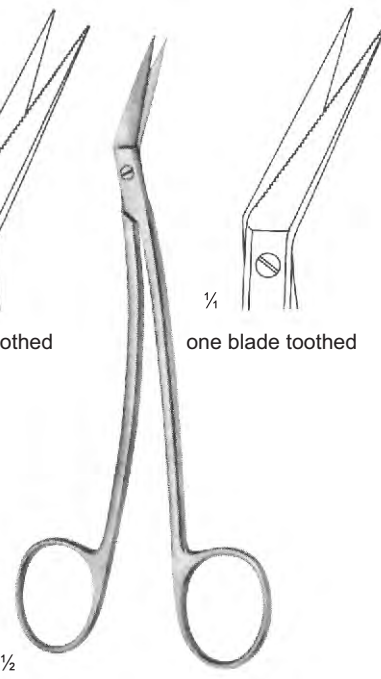
NEUMANN
 Ai 04-1454-12
 12 cm/4 3/4"



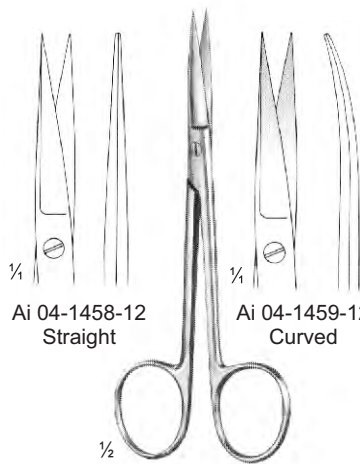
Ai 04-1455-08
 8 cm/3 1/4"
 delicate



LOCKLIN
 Ai 04-1456-16
 16 cm/6 1/4"

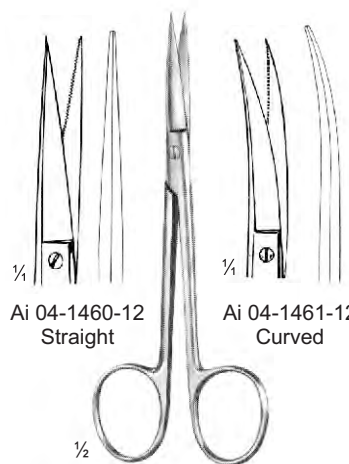


LOCKLIN
 Ai 04-1457-16
 16 cm/6 1/4"



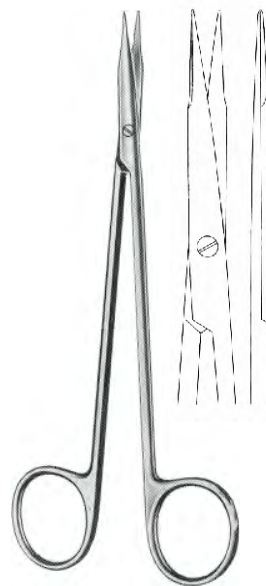
Ai 04-1458-12
 Straight

WAGNER
 12 cm/4 3/4"

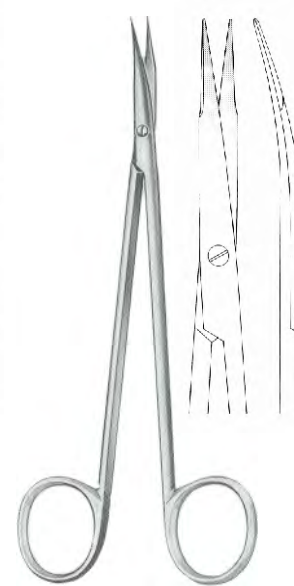


Ai 04-1459-12
 Curved

WAGNER
 12 cm/4 3/4"
 Saw edge



REYNOLDS
 Straight
 Ai 04-1462-14 14.5 cm/5 3/4"
 Ai 04-1462-15 15.5 cm/6 1/8"
 Ai 04-1462-17 17.5 cm/6 7/8"
 Ai 04-1462-18 18.0 cm/7 1/8"



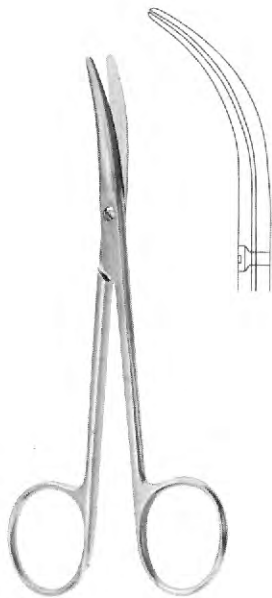
Curved
 Ai 04-1463-14
 Ai 04-1463-15
 Ai 04-1463-17
 Ai 04-1463-18



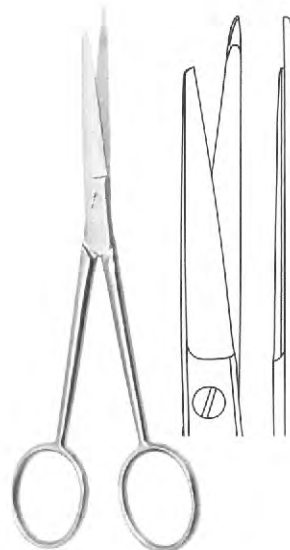
SCHUMACHER
 Ai 04-1464-16
 16 cm/6 1/4"



LANDOLT
 Ai 04-1465-12
 12.5 cm/4 7/8"

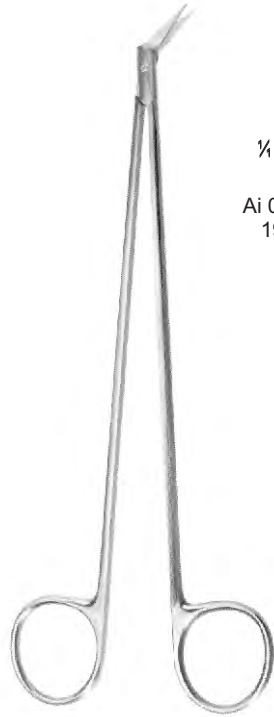


LANDOLT
 Ai 04-1466-12
 12.5 cm/4 7/8"



Ai 04-1467-14
 14.5 cm/5 3/4"





DIETHRICH



25°
 Ai 04-1468-19
 19 cm/7 1/2"



45°
 Ai 04-1468-18
 18 cm/7 1/8"



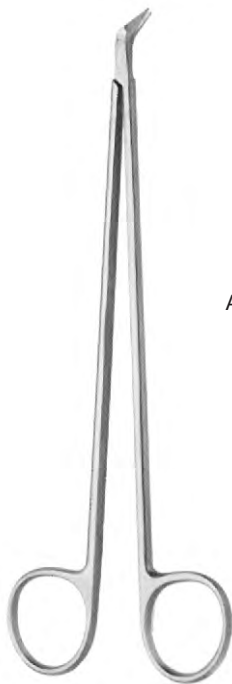
60°
 Ai 04-1468-17
 17.5 cm/6 7/8"



90°
 Ai 04-1469-17
 17.5 cm/6 7/8"



125°
 Ai 04-1470-17
 17.5 cm/6 7/8"



MICRO-HEGEMANN
 19 cm/7 1/2"



25°
 Ai 04-1471-19



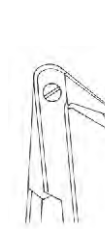
45°
 Ai 04-1472-19



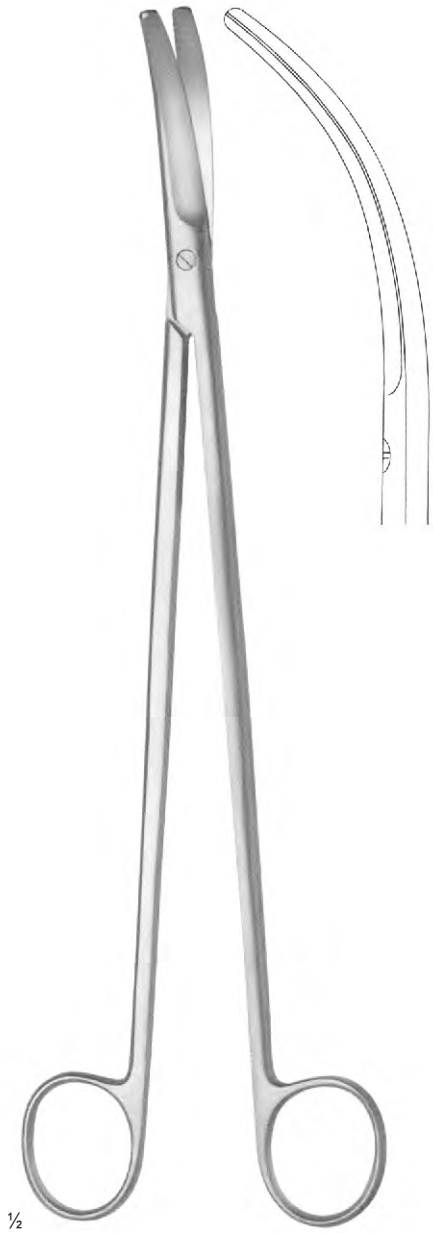
60°
 Ai 04-1473-19



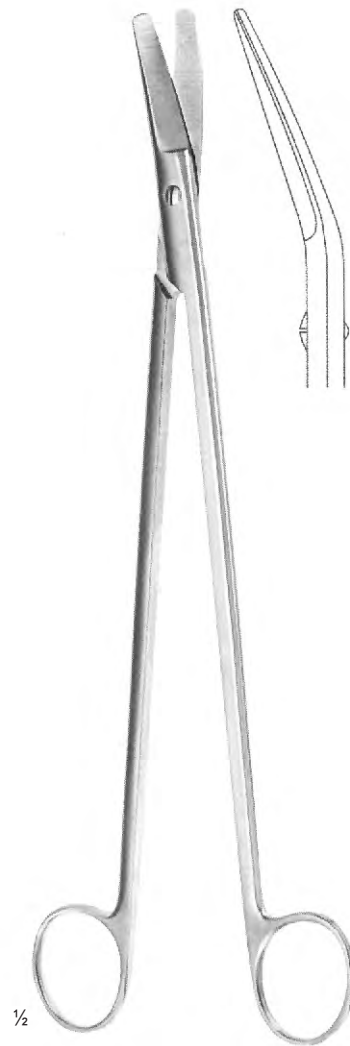
90°
 Ai 04-1474-19



125°
 Ai 04-1475-19

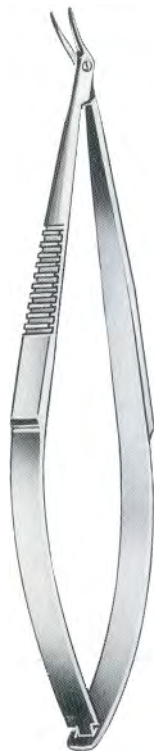


RECTAL
 Ai 04-1476-32
 32.5 cm/12 3/4"

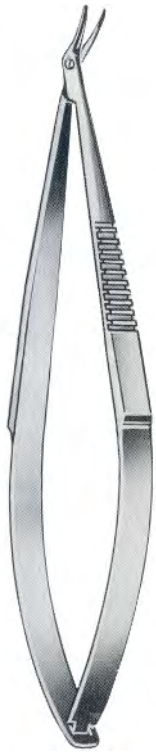


FINOCHIETTO
 Ai 04-1477-27
 27 cm/10 1/2"

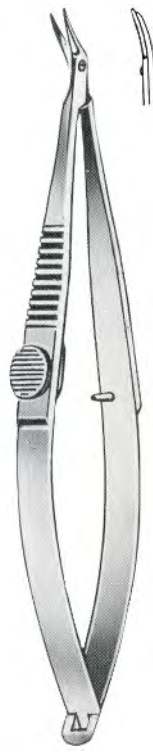




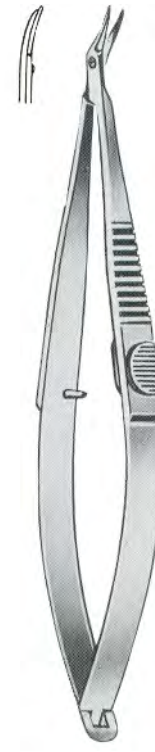
TROUTMAN
 Ai 04-1478-10
 10 cm/4"



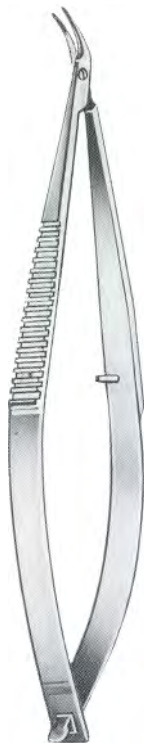
TROUTMAN
 Ai 04-1479-10
 10 cm/4"



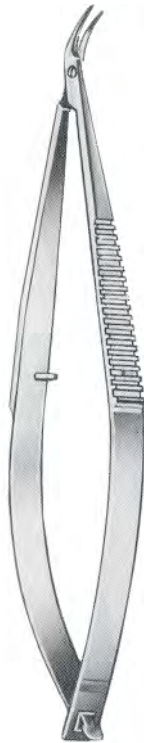
KATZIN-BARRAQUER
 Ai 04-1480-10
 10 cm/4"



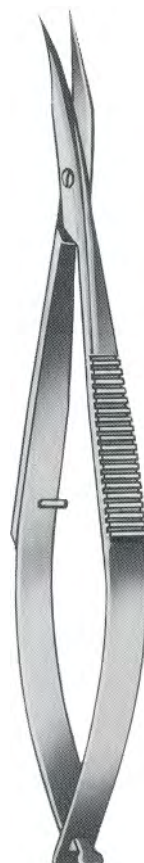
KATZIN-BARRAQUER
 Ai 04-1481-10
 10 cm/4"



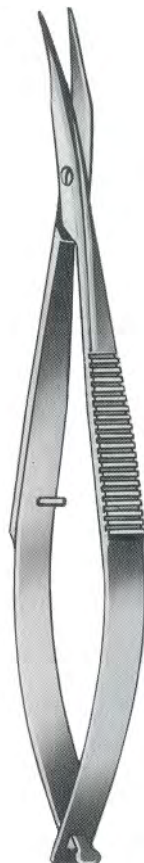
KATZIN
 Ai 04-1482-10
 10 cm/4"



KATZIN
 Ai 04-1483-10
 10 cm/4"



WESTCOTT
 Ai 04-1484-11
 11 cm/4½"



WESTCOTT
 Ai 04-1485-11
 11 cm/4½"



WESTCOTT
 Ai 04-1486-11
 11 cm/4½"



Ai 04-1487-10
10 cm/4"



Ai 04-1488-10
10 cm/4"



CASTROVIEJO
Ai 04-1489-10
10 cm/4"



CASTROVIEJO
Ai 04-1490-10
10 cm/4"



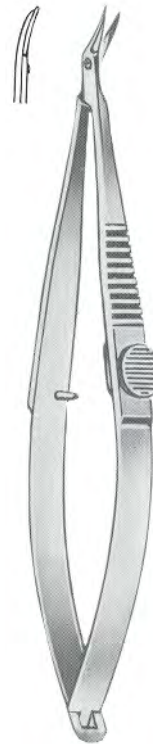
AEBLI
Ai 04-1491-10
10 cm/4"



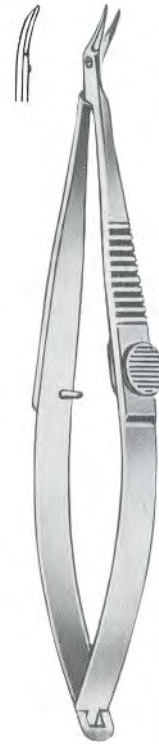
CASTROVIEJO
Ai 04-1492-10
10 cm/4"



CASTROVIEJO
Ai 04-1493-10
10 cm/4"

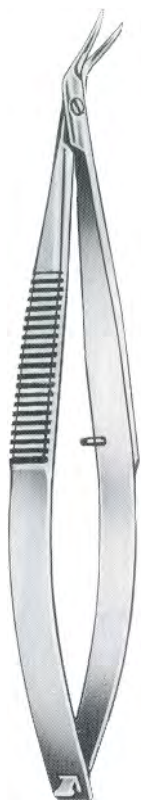


TROUTMAN-BARRAQUER
Ai 04-1494-10
10 cm/4"

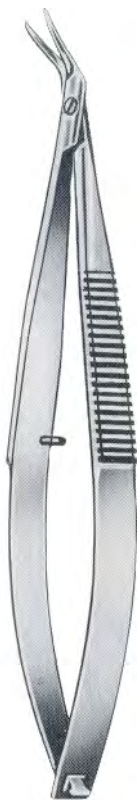


TROUTMAN-BARRAQUER
Ai 04-1495-10
10 cm/4"

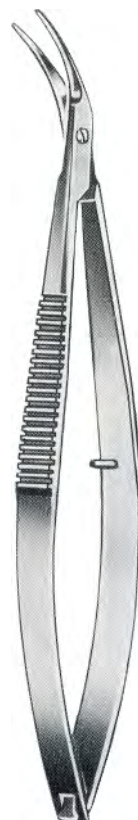




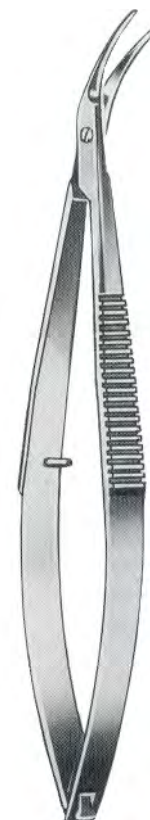
CASTROVIEJO
 Ai 04-1496-10
 10 cm/4"



CASTROVIEJO
 Ai 04-1497-10
 10 cm/4"



CASTROVIEJO
 Ai 04-1498-11
 11.5 cm/4½"



CASTROVIEJO
 Ai 04-1499-11
 11.5 cm/4½"



TROUTMANN-CASTROVIEJO
 Ai 04-1500-10
 10.5 cm/4¼"



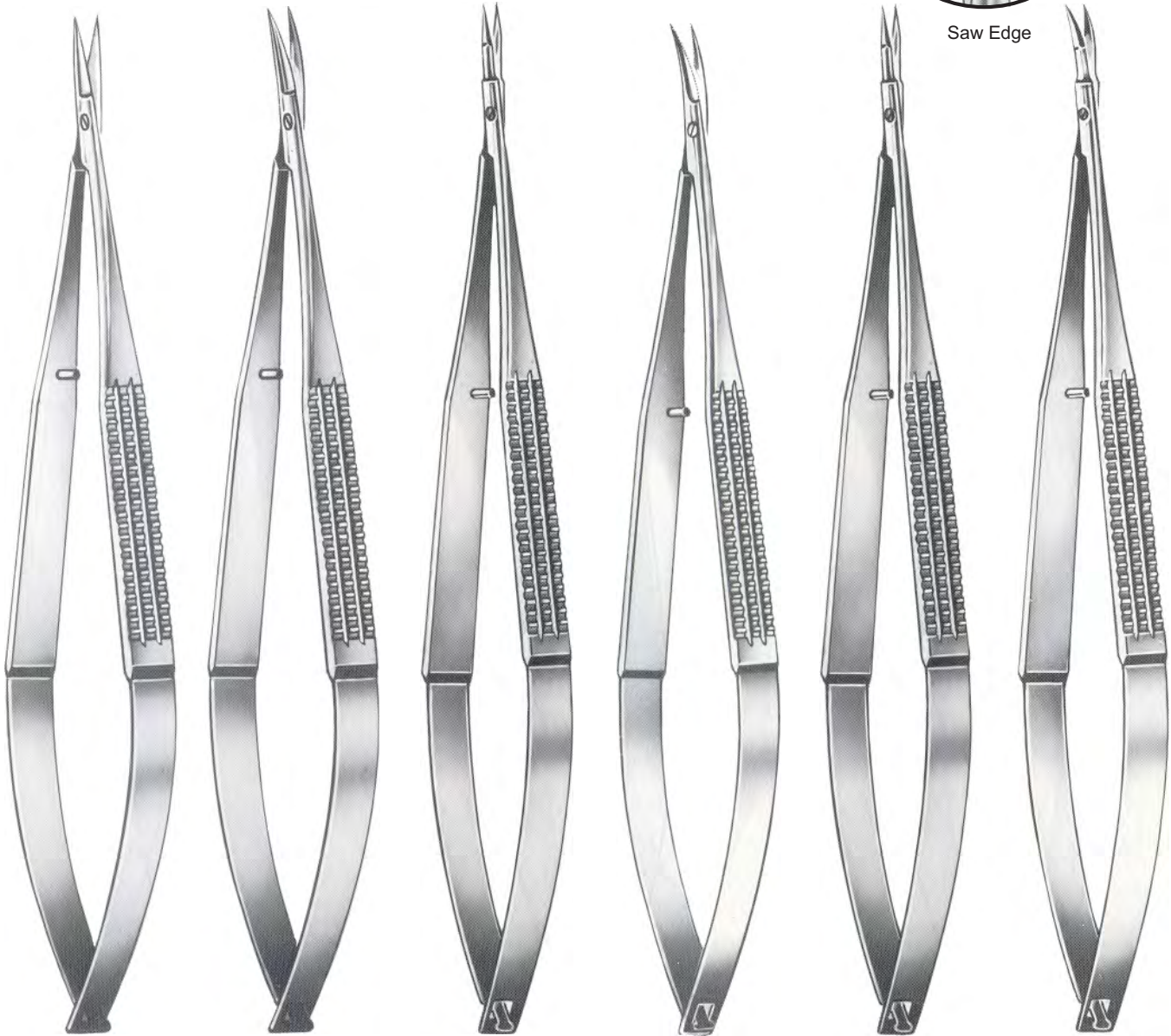
TROUTMANN-CASTROVIEJO
 Ai 04-1501-10
 10.5 cm/4¼"



14.5 cm/5¾"
 18.0 cm/7"

Straight
 Ai 04-1502-14
 Ai 04-1502-18

Curved
 Ai 04-1503-14
 Ai 04-1503-18



Saw Edge

Straight
 Ai 04-1504-16
 16cm/6¼"

Curved
 Ai 04-1505-16
 16cm/6¼"

Straight
 Ai 04-1506-16
 16cm/6¼"

Curved
 Ai 04-1507-16
 16cm/6¼"

MILLESI
 Straight
 Ai 04-1508-16
 16cm/6¼"

MILLESI
 Curved
 Ai 04-1509-16
 16cm/6¼"





Straight
Ai 04-1510-14
14.5cm/5¾"



Curved
Ai 04-1511-14
14.5cm/5¾"

Dissecting Scissors



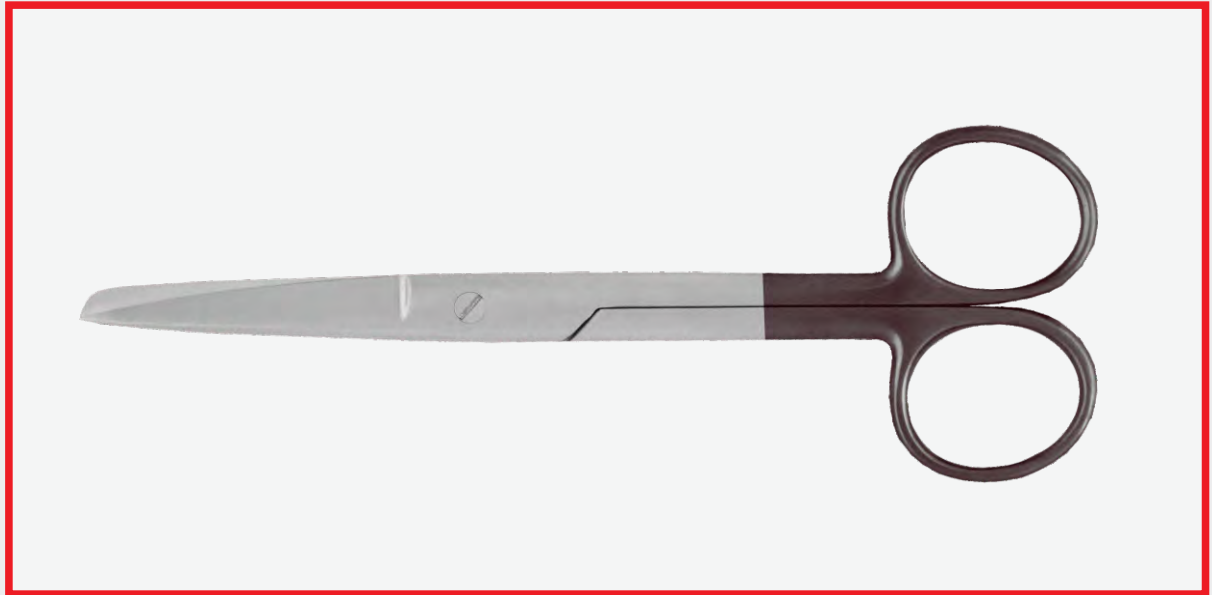
Curved
Ai 04-1512-14
14.5cm/5¾"

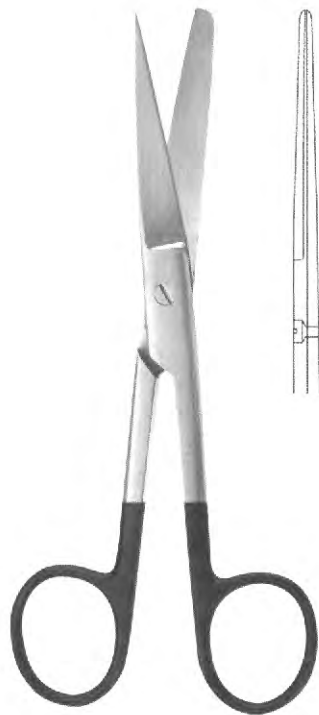
EN Super-Cut Scissors

DE Super-Cut Scheren

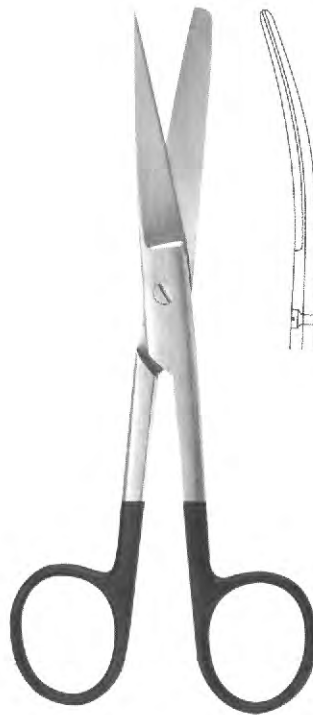
ES Tijeras Super-Cut

Page 65 to 74

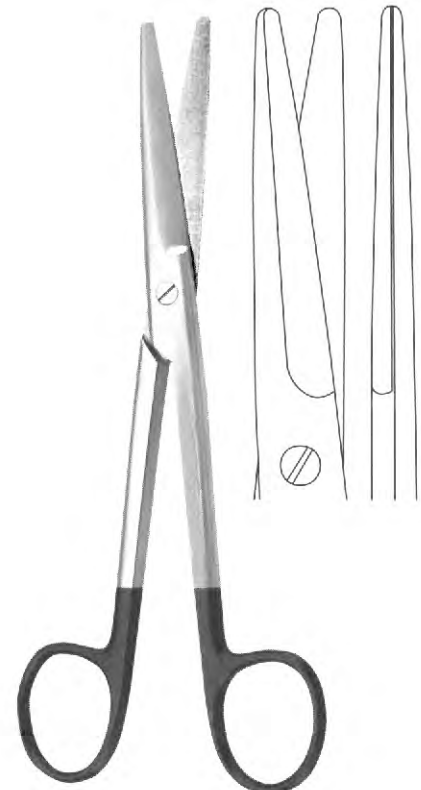




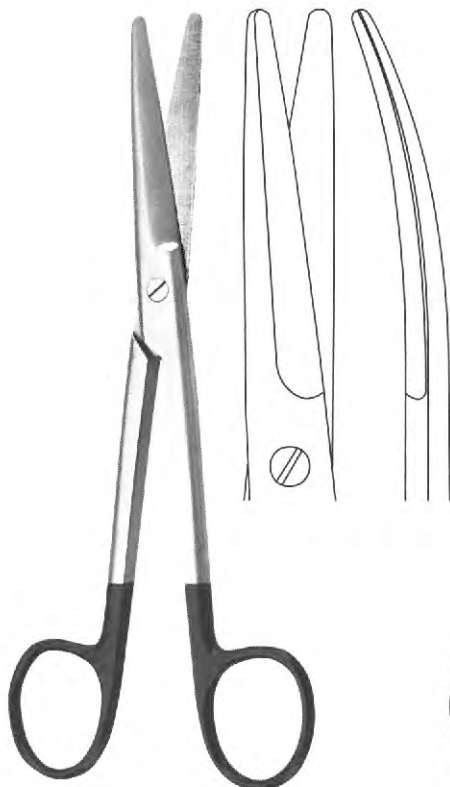
STANDARD
 Ai 05-1601-14
 14.5 cm/5 3/4"



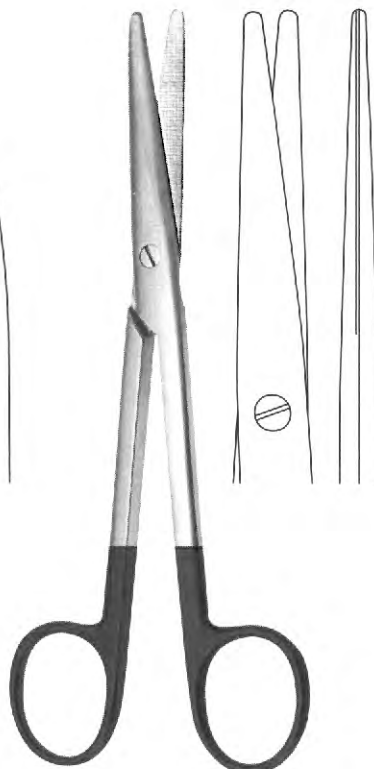
STANDARD
 Ai 05-1602-14
 14.5 cm/5 3/4"



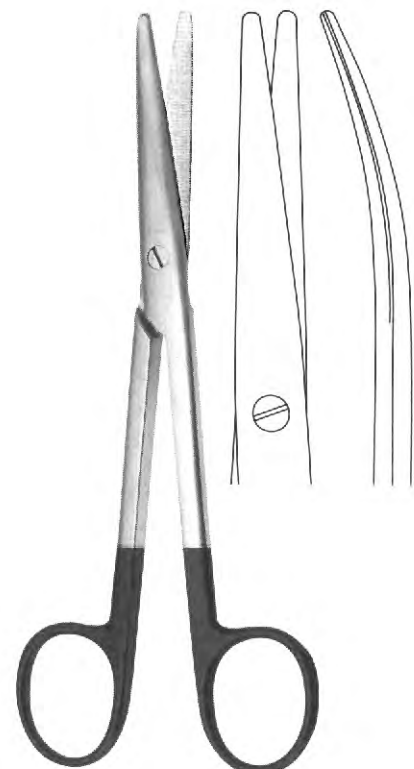
MAYO
 Ai 05-1603-14 14.5 cm/5 3/4"
 Ai 05-1603-17 17 cm/6 3/4"
 Ai 05-1603-23 23 cm/9"



MAYO
 Ai 05-1604-14 14.5 cm/5 3/4"
 Ai 05-1604-17 17 cm/6 3/4"
 Ai 05-1604-23 23 cm/9"



MAYO-STILLE
 Ai 05-1605-15 15 cm/5 7/8"
 Ai 05-1605-17 17 cm/6 3/4"

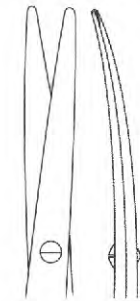


MAYO-STILLE
 Ai 05-1606-16 15 cm/5 7/8"
 Ai 05-1606-17 17 cm/6 3/4"



Ai 05-1607-11

METZENBAUM
 11.5 cm/4 1/2"

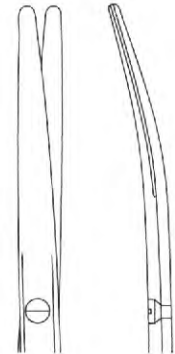
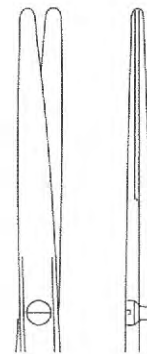


Ai 05-1608-11



Ai 05-1609-14

METZENBAUM
 14.5 cm/5 3/4"



Ai 05-1610-14



METZENBAUM-NELSON
 Ai 05-1611-18 18 cm/7 1/8"
 Ai 05-1611-20 20 cm/7 7/8"
 Ai 05-1611-23 23 cm/9"
 Ai 05-1611-26 26 cm/10 1/4"



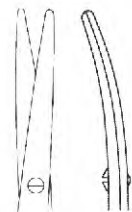
METZENBAUM-NELSON
 Ai 05-1612-18 18 cm/7 1/8"
 Ai 05-1612-20 20 cm/7 7/8"
 Ai 05-1612-23 23 cm/9"
 Ai 05-1612-26 26 cm/10 1/4"





Ai 05-1613-11

STRABISMUS
11.5 cm/4 1/2"

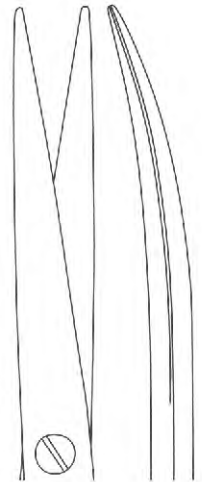
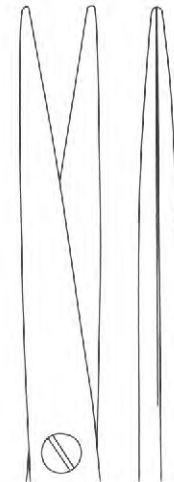


Ai 05-1614-11

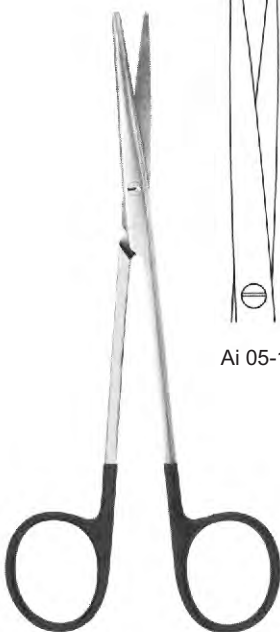


Ai 05-1615-16

LEXER
16 cm/6 1/4"



Ai 05-1616-16

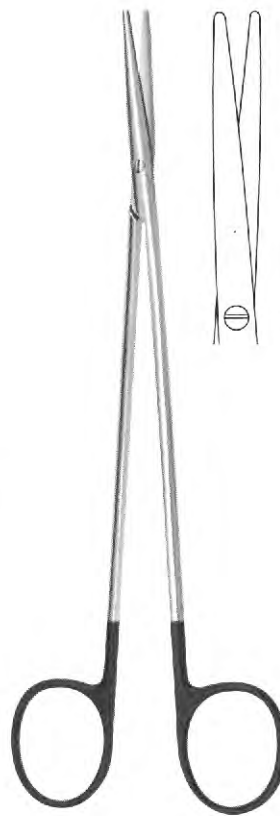


Ai 05-1617-14

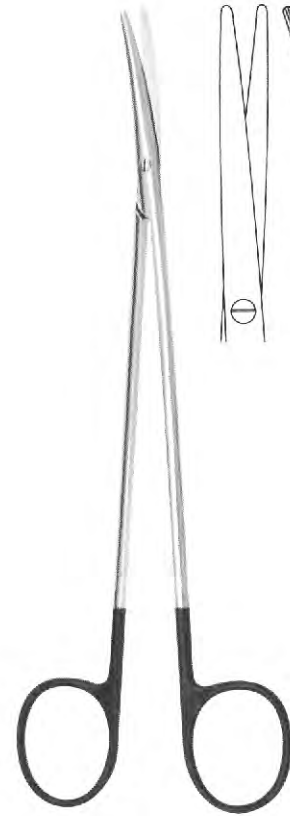
METZENBAUM-FINO
14.5 cm/5 3/4"



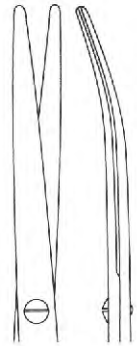
Ai 05-1618-14



METZENBAUM-FINO
 Ai 05-1619-18 18 cm/7 1/8"
 Ai 05-1619-20 20 cm/7 7/8"
 Ai 05-1619-23 23 cm/9"

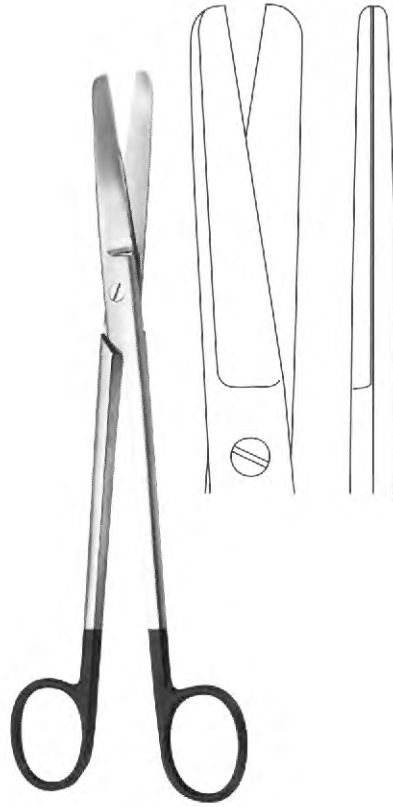


METZENBAUM-FINO
 Ai 05-1620-18 18 cm/7 1/8"
 Ai 05-1620-20 20 cm/7 7/8"
 Ai 05-1620-23 23 cm/9"

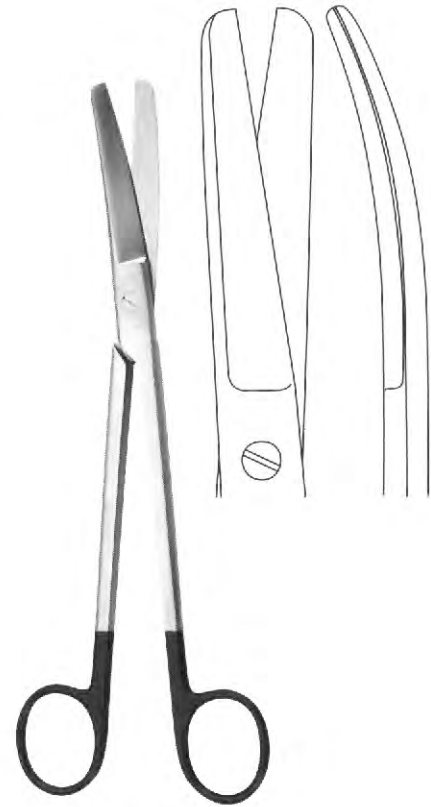




TOENNIS-ADSON
 Ai 05-1621-17
 17.5 cm/6 7/8"



SIMS
 Ai 05-1622-20
 20 cm/7 7/8"



SIMS
 Ai 05-1623-20 20 cm/7 7/8"
 Ai 05-1623-23 23 cm/9"



SIEBOLD
 Ai 05-1624-24
 24 cm/9 1/2"

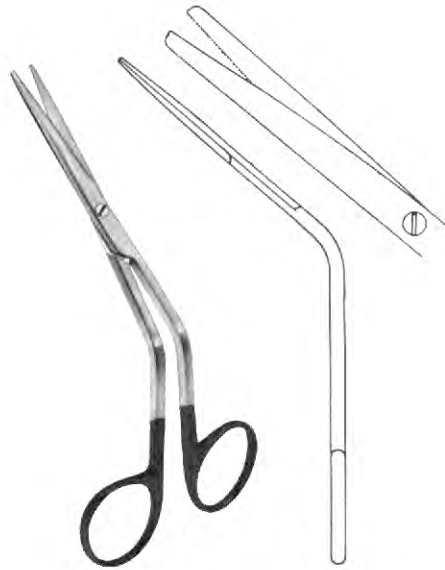


WALDMANN
 Ai 05-1625-18
 18 cm/7 1/8"

Episiotomy scissors



Ai 05-1626-20
 20 cm/7 7/8"



FOMON
Ai 05-1627-13
13.5 cm/5 3/8"



FOMON
Ai 05-1628-14
14.5 cm/5 3/4"

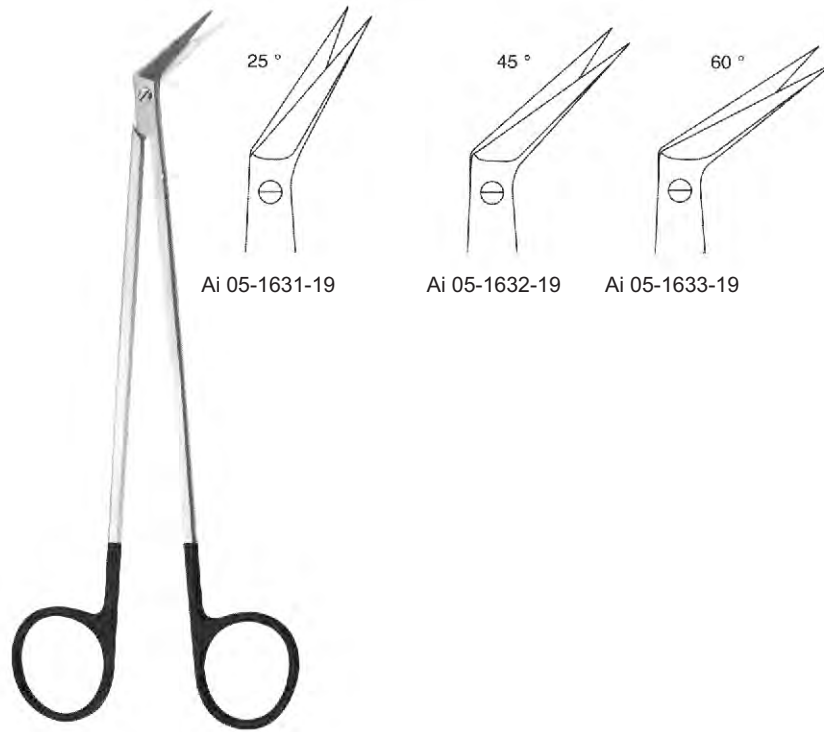


COTTLE
Ai 05-1629-16
16 cm/6 1/4"



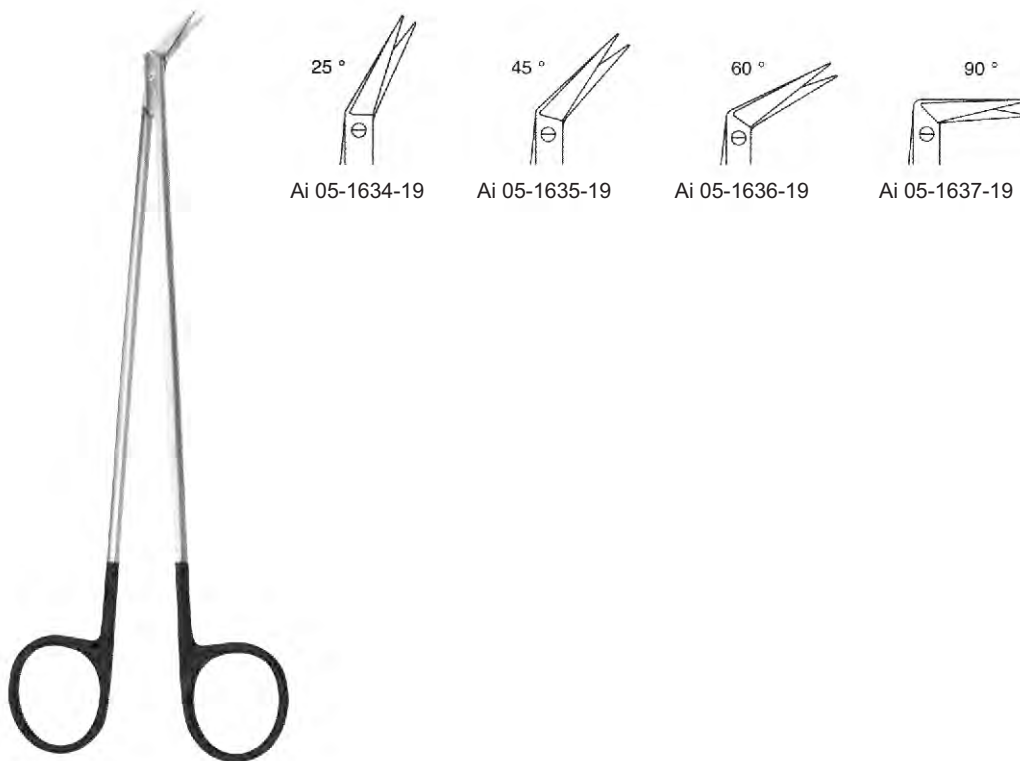
HEYMANN
Ai 05-1630-18
18 cm/7 1/8"





25° Ai 05-1631-19
45° Ai 05-1632-19
60° Ai 05-1633-19

POTTS-SMITH
19 cm/7 1/2"



25° Ai 05-1634-19
45° Ai 05-1635-19
60° Ai 05-1636-19
90° Ai 05-1637-19

DIETRICH
19 cm/7 1/2"





Ai 05-1638-16

Ai 05-1639-16

Fistula scissors

KELLY
16 cm/6 1/4"



Ai 05-1640-14

Ai 05-1641-14

JOSEPH
14 cm/5 1/2"



Ai 05-1642-11

Ai 05-1643-11

IRIS
11.5 cm/4 1/2"



Ai 05-1644-12

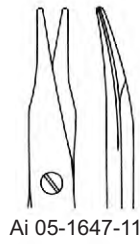
Ai 05-1645-12

WAGNER
12 cm/4 3/4"

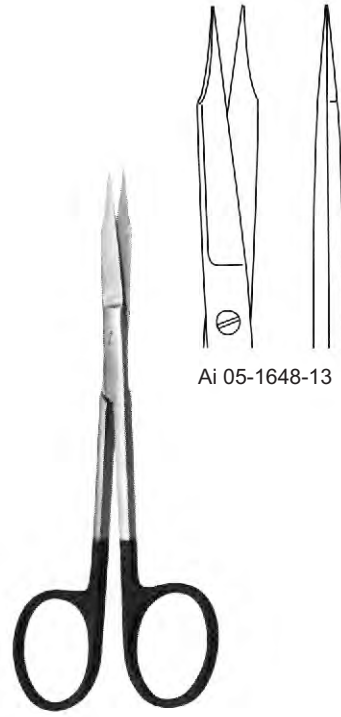


Ai 05-1646-11

STEVENS
11.5 cm/4 1/2"

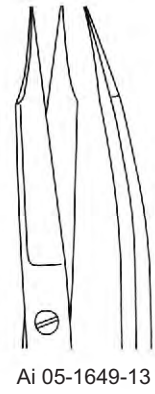


Ai 05-1647-11

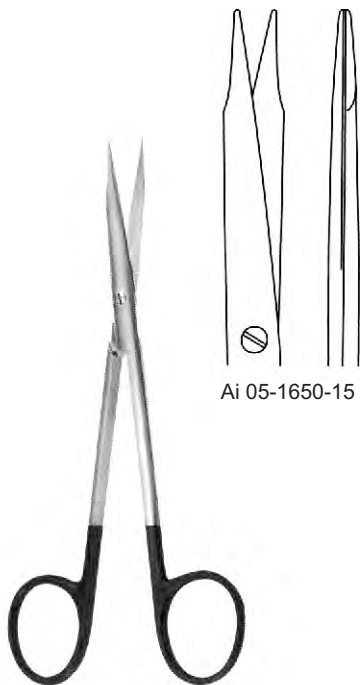


Ai 05-1648-13

GOLDMANN-FOX
13 cm/5 1/8"

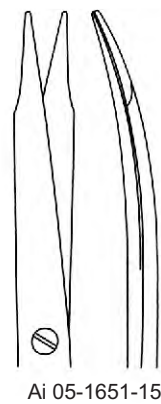


Ai 05-1649-13



Ai 05-1650-15

REYNOLDS
15 cm/5 7/8"

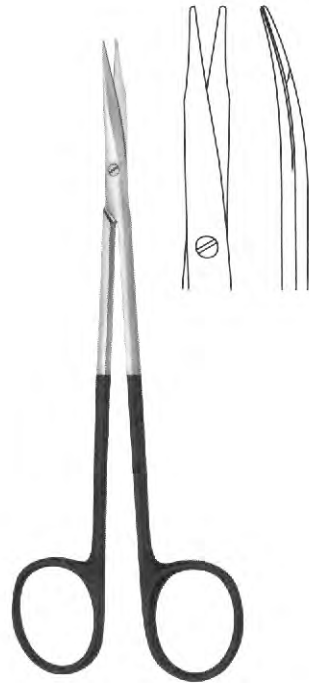


Ai 05-1651-15



REYNOLDS
Ai 05-1652-17
17.5 cm/6 7/8"



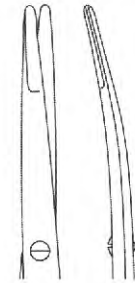


JAMESON
Ai 05-1653-15
15 cm/5 7/8"



Ai 05-1654-12

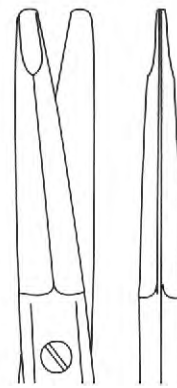
PAR-TYPE
12 cm/4 3/4"



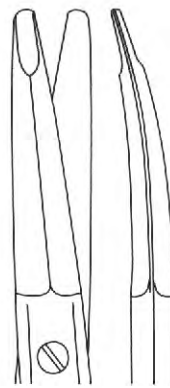
Ai 05-1655-12



KAYE FACE LIFT
Ai 05-1656-15 15 cm/5 7/8"
Ai 05-1657-19 19 cm/7 1/2"



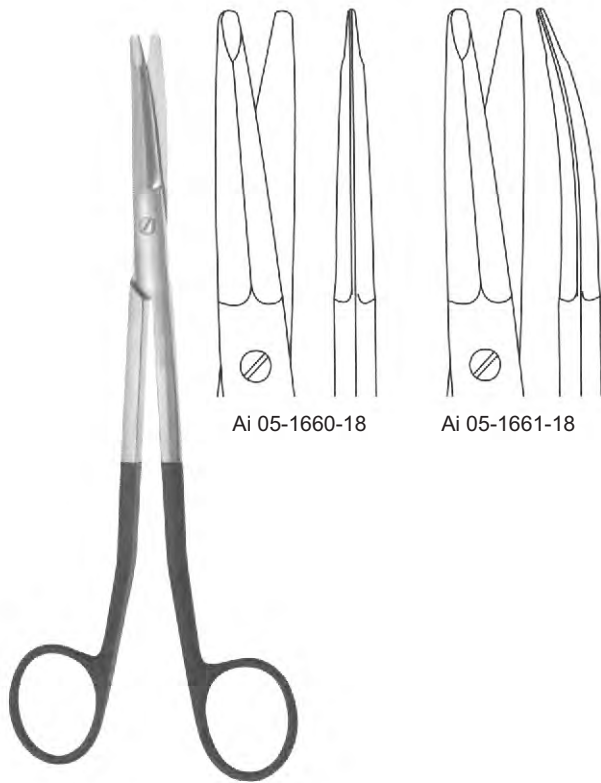
Ai 05-1658-19



Ai 05-1659-19



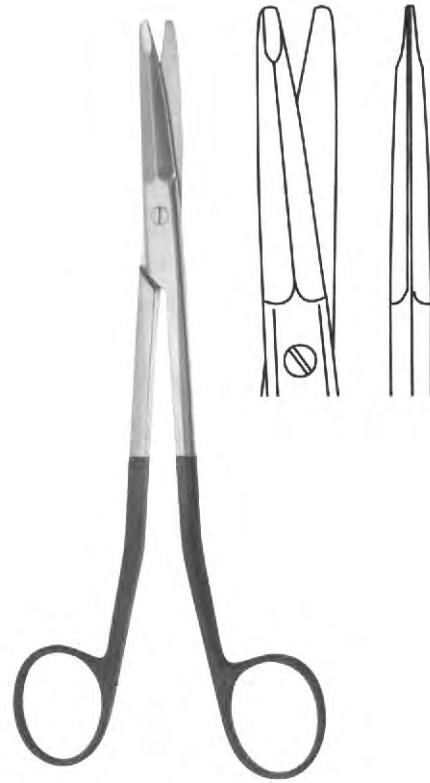
GORNEY
19 cm/7 1/2"



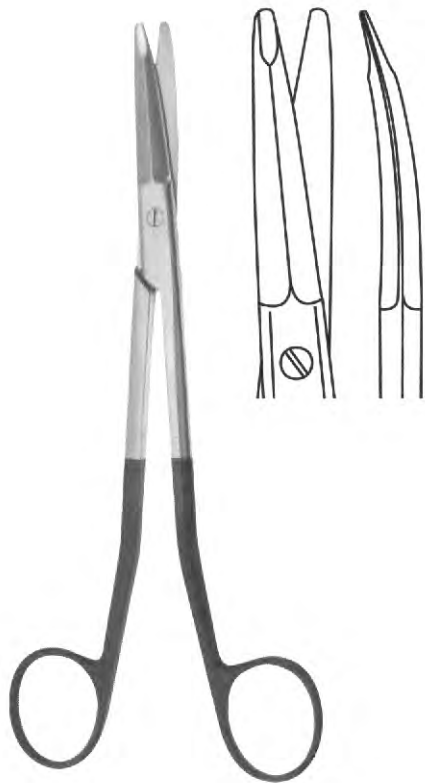
Ai 05-1660-18

Ai 05-1661-18

FREEMANN-KAYE
 18 cm/7 1/8"



FREEMANN-KAYE
 Ai 05-1662-19 19 cm/7 1/2"
 Ai 05-1662-23 23 cm/9"



FREEMANN-GORNEY
 Ai 05-1663-19 19 cm/7 1/2"
 Ai 05-1663-23 23 cm/9"



LISTER
 Ai 05-1664-14 14 cm/5 1/2"
 Ai 05-1664-18 18 cm/7 1/8"
 Ai 05-1664-20 20 cm/7 7/8"

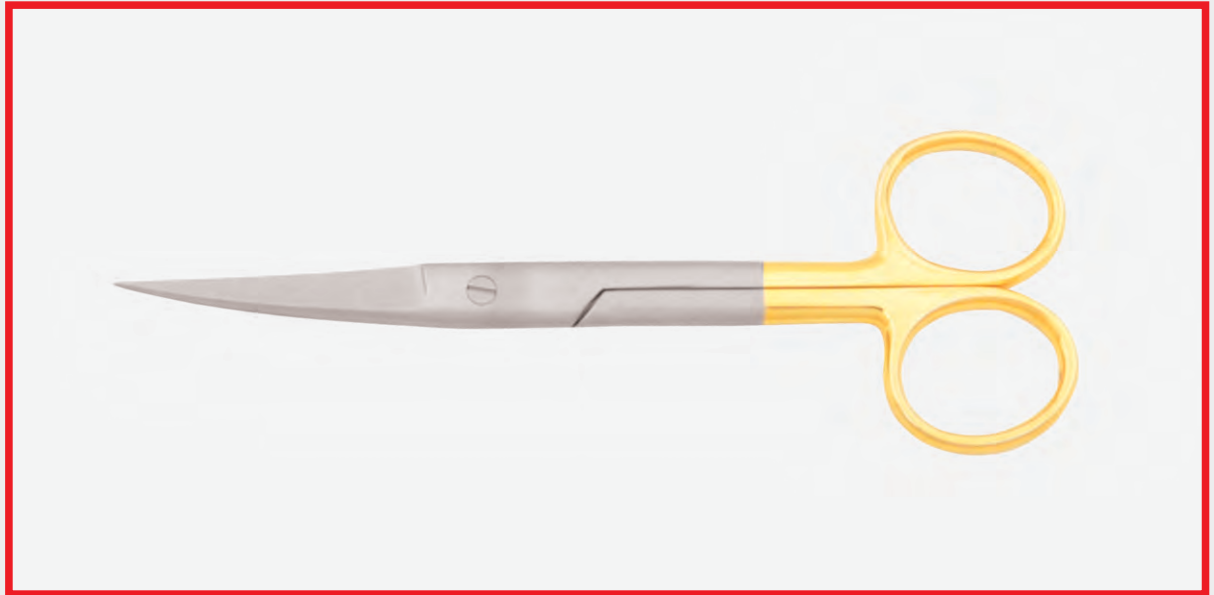


EN TC Scissors

DE TC Scheren

ES Tijeras TC

Page 75 to 84



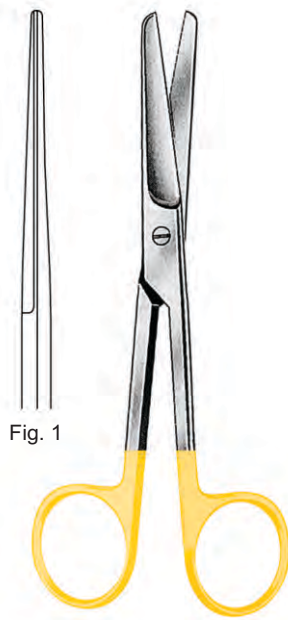


Fig. 1

STANDARD
 Ai 06-1801-14
 14.5 cm/5 3/4"

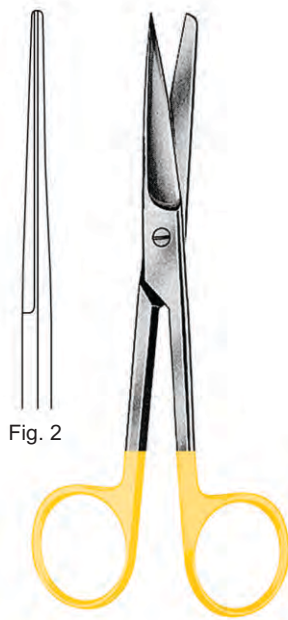


Fig. 2

STANDARD
 Ai 06-1802-14
 14.5 cm/5 3/4"

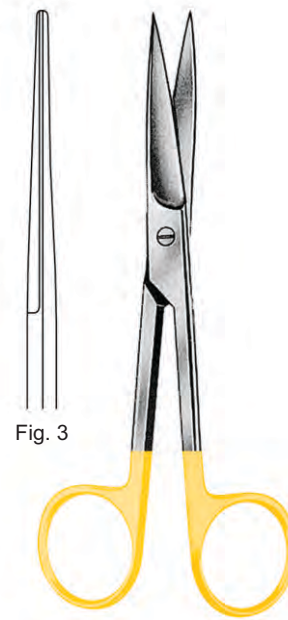


Fig. 3

STANDARD
 Ai 06-1803-14
 14.5 cm/5 3/4"

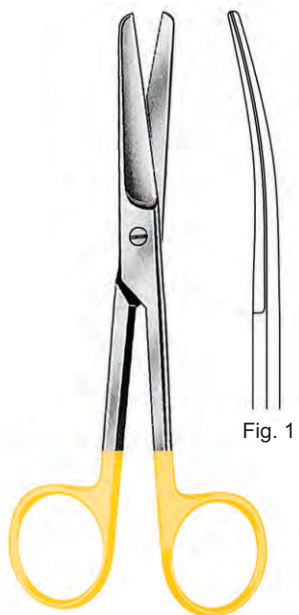


Fig. 1

STANDARD
 Ai 06-1804-14
 14.5 cm/5 3/4"

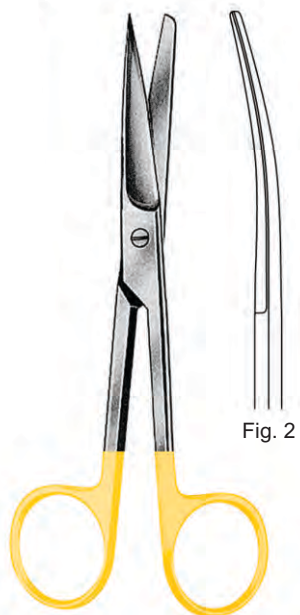


Fig. 2

STANDARD
 Ai 06-1805-14
 14.5 cm/5 3/4"

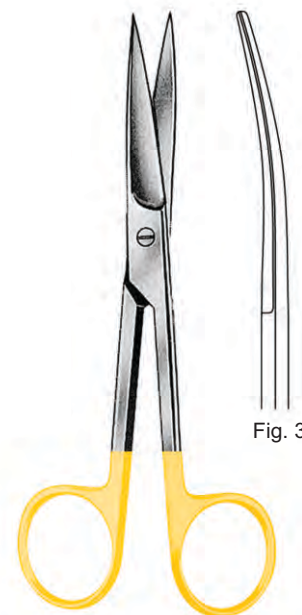
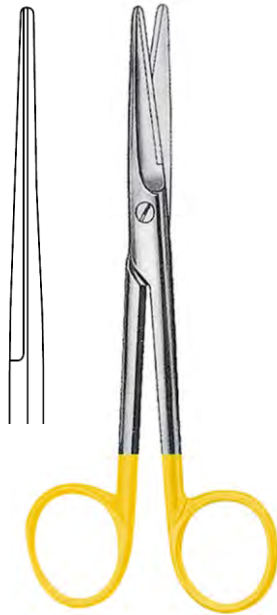
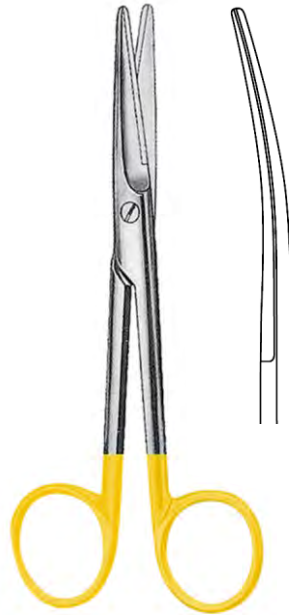


Fig. 3

STANDARD
 Ai 06-1806-14
 14.5 cm/5 3/4"



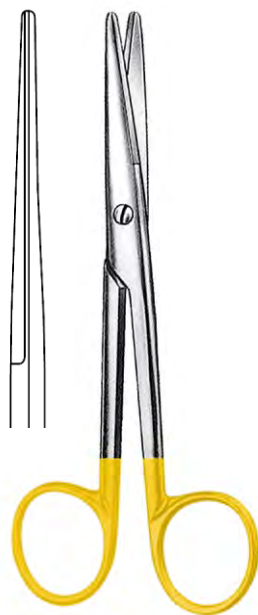
MAYO-Straight
 Ai 06-1807-14 14.5 cm/5 3/4"
 Ai 06-1807-17 17 cm/6 3/4"
 Ai 06-1807-23 23 cm/9"



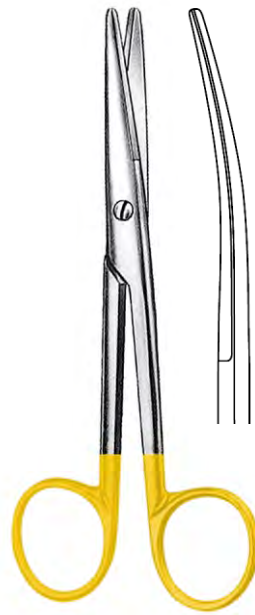
MAYO-Curved
 Ai 06-1808-14 14.5 cm/5 3/4"
 Ai 06-1808-17 17 cm/6 3/4"
 Ai 06-1808-23 23 cm/9"



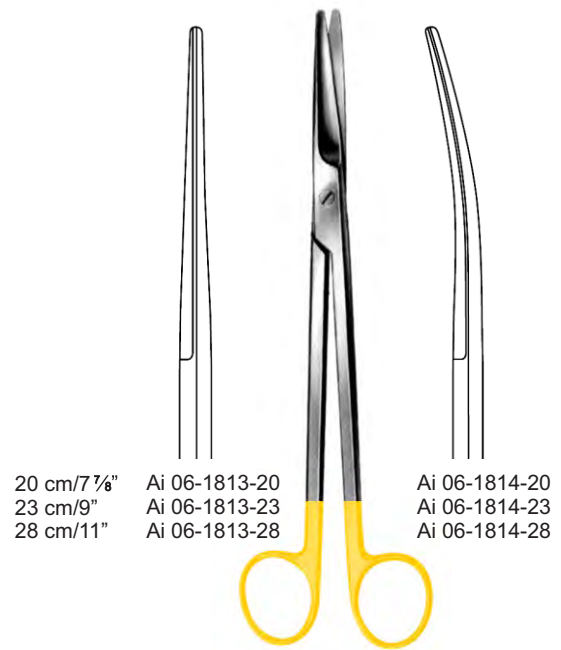
Ai 06-1809-16 Ai 06-1810-16
 1/2
MAYO-LEXER
 Dissecting
 16 cm/6 1/4"



MAYO-STILLE
 Ai 06-1811-14 14.5 cm/5 3/4"
 Ai 06-1811-17 17 cm/6 3/4"

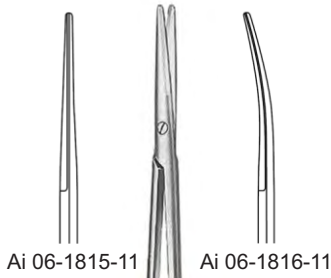


MAYO-STILLE
 Ai 06-1812-14 14.5 cm/5 3/4"
 Ai 06-1812-17 17 cm/6 3/4"



20 cm/7 7/8" Ai 06-1813-20
 23 cm/9" Ai 06-1813-23
 28 cm/11" Ai 06-1813-28
 Ai 06-1814-20
 Ai 06-1814-23
 Ai 06-1814-28
MAYO-HARRINGTON
 Gynecological



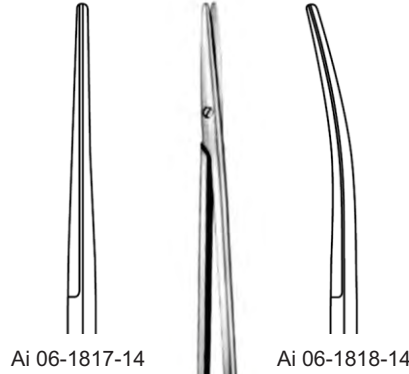


Ai 06-1815-11 Ai 06-1816-11



½

METZENBAUM
11.5 cm/4 ½"

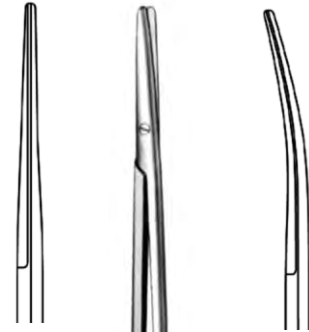


Ai 06-1817-14 Ai 06-1818-14



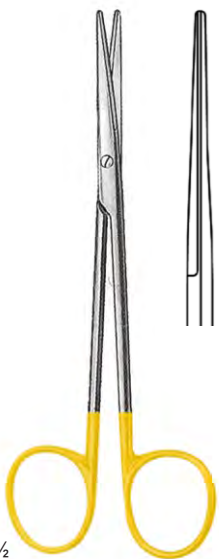
½

METZENBAUM
14.5 cm/5 ¾"



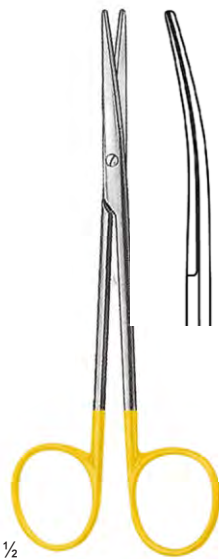
METZENBAUM

	Straight	Curved
Ai 06-1819-18	18 cm/7 1/8"	Ai 06-1820-18
Ai 06-1819-20	20 cm/7 7/8"	Ai 06-1820-20
Ai 06-1819-23	23 cm/9"	Ai 06-1820-23
Ai 06-1819-25	25 cm/9 7/8"	Ai 06-1820-25
Ai 06-1819-28	28 cm/11"	Ai 06-1820-28
Ai 06-1819-30	30 cm/11 3/4"	Ai 06-1820-30



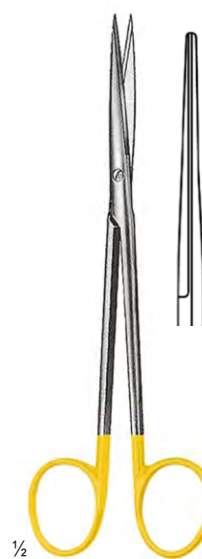
½

METZENBAUM-Fino
Ai 06-1821-14
14.5 cm/5 ¾"



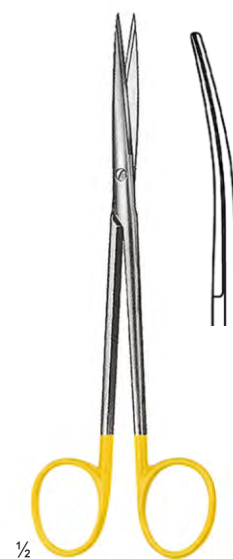
½

METZENBAUM-Fino
Ai 06-1822-14
14.5 cm/5 ¾"



½

METZENBAUM-Fino
Ai 06-1823-14
14.5 cm/5 ¾"



½

METZENBAUM-Fino
Ai 06-1824-14
14.5 cm/5 ¾"



METZENBAUM-Fino
 Ai 06-1825-18 18 cm/7 1/8"
 Ai 06-1825-20 20 cm/7 7/8"
 Ai 06-1825-23 23 cm/9"
 Ai 06-1825-25 25 cm/9 7/8"
 Ai 06-1825-28 28 cm/11"



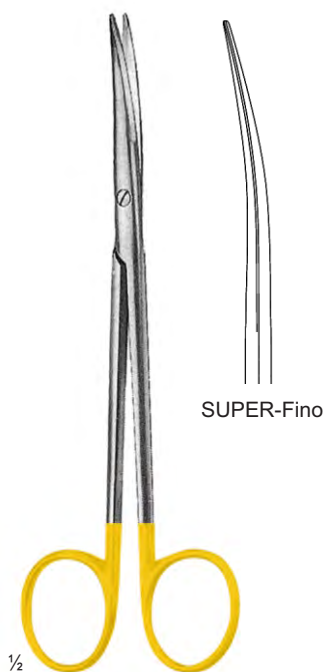
METZENBAUM-Fino
 Ai 06-1826-18 18 cm/7 1/8"
 Ai 06-1826-20 20 cm/7 7/8"
 Ai 06-1826-23 23 cm/9"
 Ai 06-1826-25 25 cm/9 7/8"
 Ai 06-1826-28 28 cm/11"



METZENBAUM-Fino
 Ai 06-1827-18 18 cm/7 1/8"
 Ai 06-1827-20 20 cm/7 7/8"
 Ai 06-1827-23 23 cm/9"
 Ai 06-1827-25 25 cm/9 7/8"
 Ai 06-1827-28 28 cm/11"

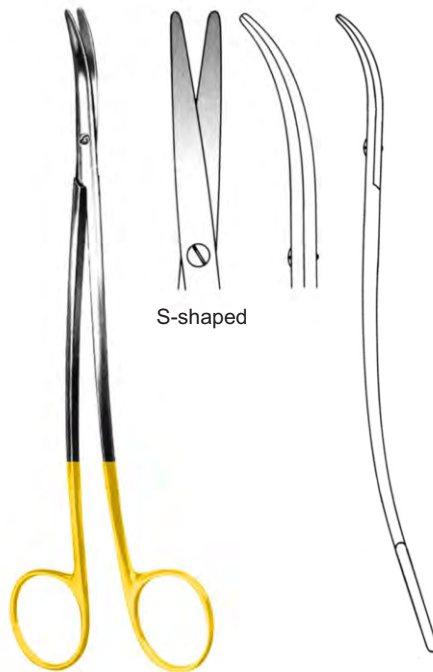


METZENBAUM-Fino
 Ai 06-1828-18 18 cm/7 1/8"
 Ai 06-1828-20 20 cm/7 7/8"
 Ai 06-1828-23 23 cm/9"
 Ai 06-1828-25 25 cm/9 7/8"
 Ai 06-1828-28 28 cm/11"



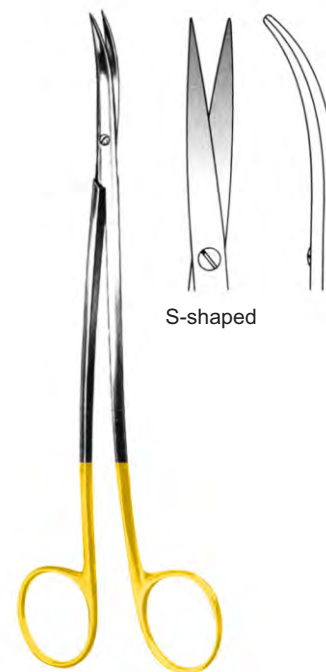
TOENNIS-ADSON
 Ai 06-1829-17
 17.5 cm/6 7/8"

SUPER-Fino



METZENBAUM-Fino
 Ai 06-1830-18 18 cm/7 1/8"
 Ai 06-1830-20 20 cm/7 7/8"
 Ai 06-1830-23 23 cm/9"

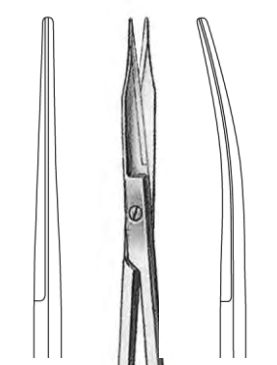
S-shaped



METZENBAUM-Fino
 Ai 06-1831-18 18 cm/7 1/8"
 Ai 06-1831-20 20 cm/7 7/8"
 Ai 06-1831-23 23 cm/9"

S-shaped

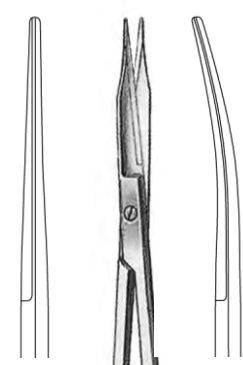




Ai 06-1832-13



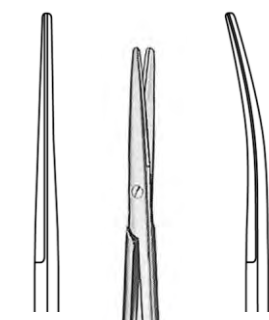
GOLDMAN-FOX
13 cm/5 1/8"



Ai 06-1833-13



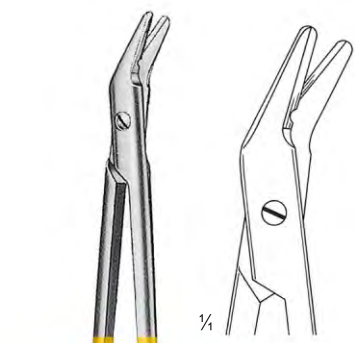
GOLDMAN-FOX
Toothed blades
13 cm/5 1/8"



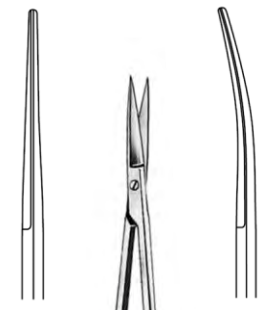
Ai 06-1836-10



KNAPP/LEXER-Baby
Starbismus
10 cm/3 7/8"



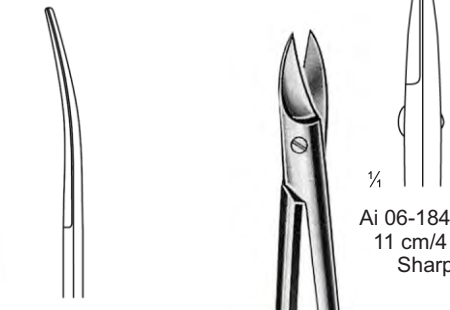
UNIVERSAL (Wire Cutting)
Ai 06-1838-12
12 cm/4 3/4"



Ai 06-1839-11



IRIS
11.5 cm/4 1/2"



Ai 06-1841-11
11 cm/4 1/2"
Sharp



BEEBEE



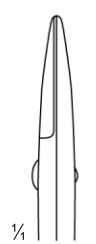
Ai 06-1842-11
11 cm/4 1/2"
Sharp



Ai 06-1843-10
10 cm/3 7/8"
Blunt



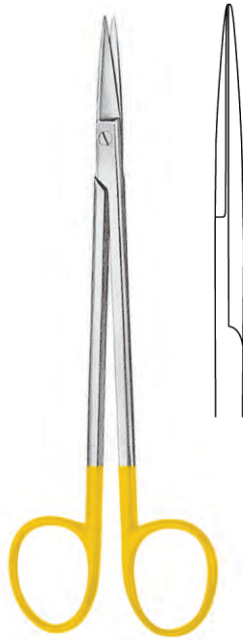
Ai 06-1844-10
10 cm/3 7/8"
Blunt



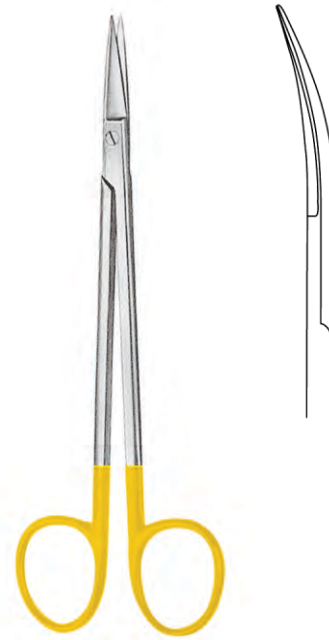
Ai 06-1845-11
11 cm/4 3/8"
Sharp



Ai 06-1846-11
11 cm/4 3/8"
1 Blade serrated



KELLY
 Ai 06-1847-16 16 cm/6 ¼"
 Ai 06-1847-18 18 cm/7 ⅛"



KELLY
 Ai 06-1848-16 16 cm/6 ¼"
 Ai 06-1848-18 18 cm/7 ⅛"

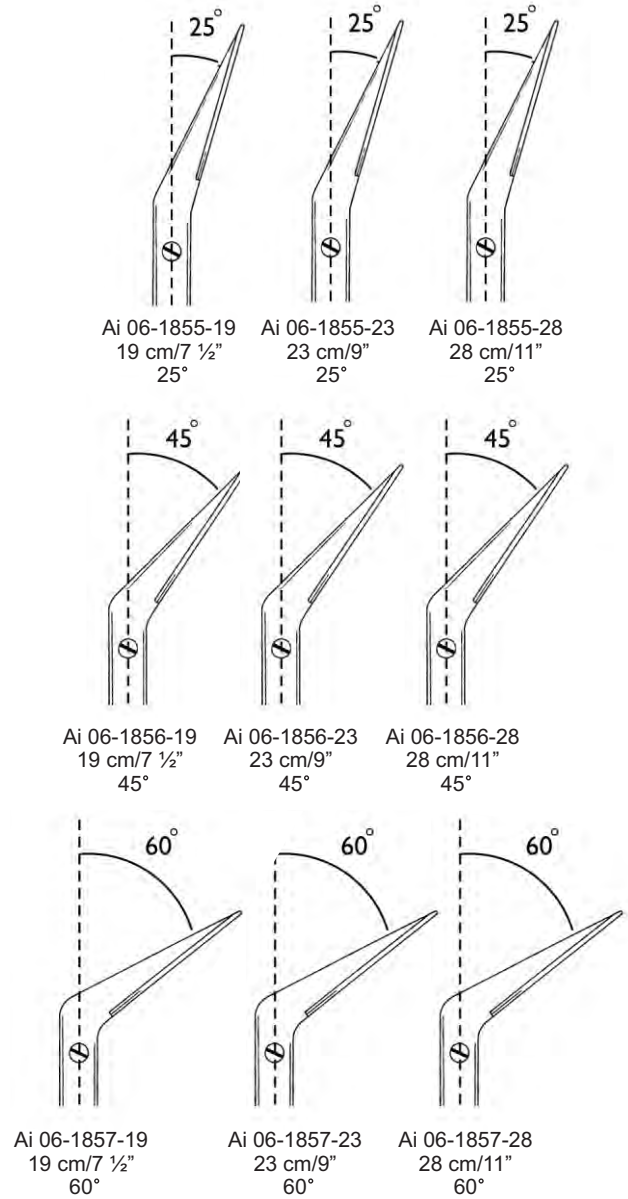
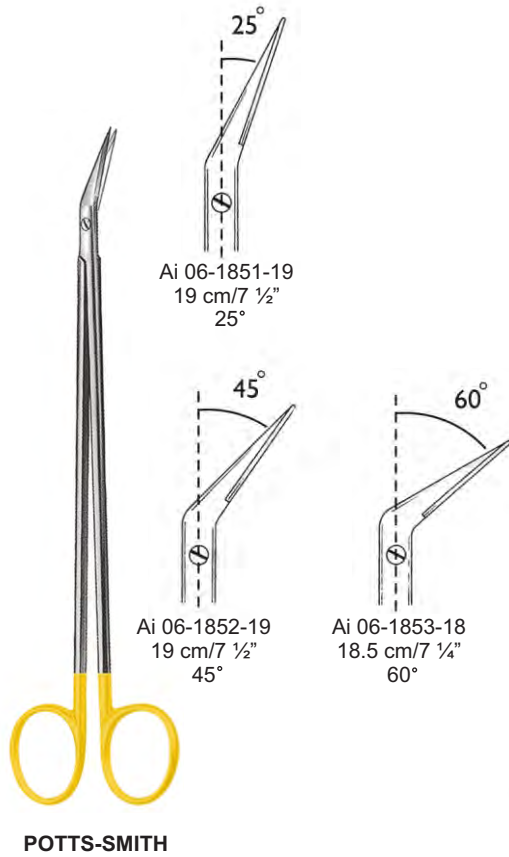


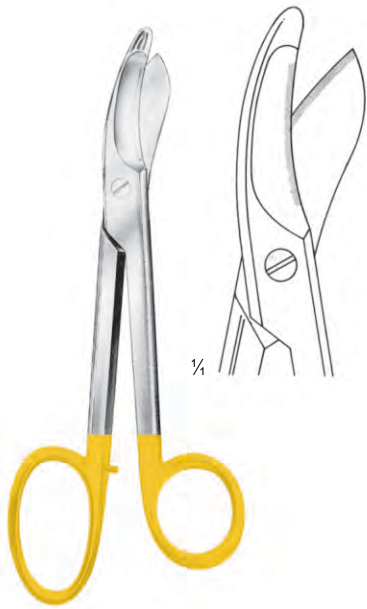
RAGNELL
 Ai 06-1849-12
 12 cm/4 ¾"



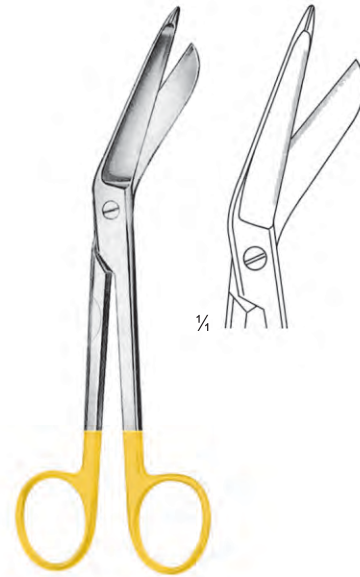
RAGNELL
 Ai 06-1850-12
 12 cm/4 ¾"



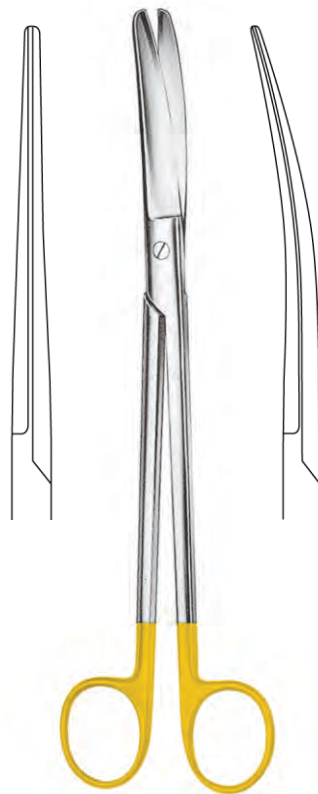




BRUNS-Plaster
 Ai 06-1858-24
 24 cm/9 1/2"



LISTER-Bandage
 Ai 06-1859-18
 18 cm/7 1/8"



SIMS (Uterine)
 Ai 06-1860-20 20 cm/7 7/8" Ai 06-1861-20
 Ai 06-1860-23 23 cm/9" Ai 06-1861-23

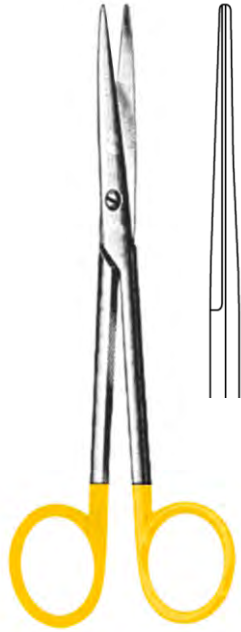




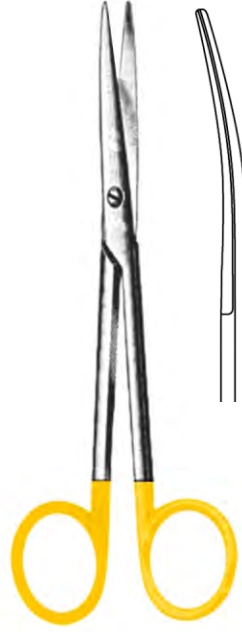
Ai 06-1862-16
16 cm/6 1/4"



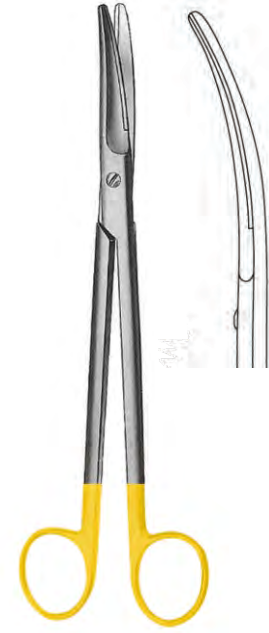
Ai 06-1863-16
16 cm/6 1/4"



LEXER
 Ai 06-1864-16 16 cm/6 1/4"
 Ai 06-1864-21 21 cm/8 1/4"



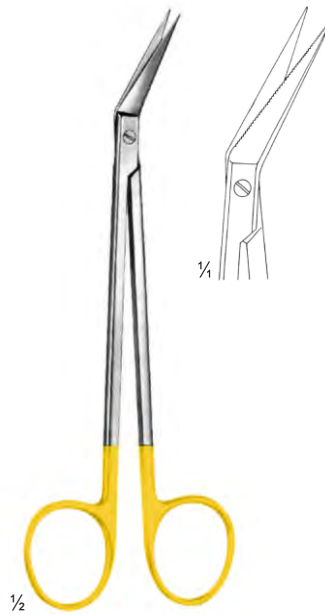
LEXER
 Ai 06-1865-16 16 cm/6 1/4"
 Ai 06-1865-21 21 cm/8 1/4"



PARAMETRIUM
 Ai 06-1866-22 22.5 cm/8 3/4"
 Ai 06-1866-23 23 cm/9"



WERTHEIM
 Ai 06-1867-22
 22.5 cm/8 3/4"



LOCKLIN
 Ai 06-1868-16
 16 cm/6 1/4"
 1 toothed blade



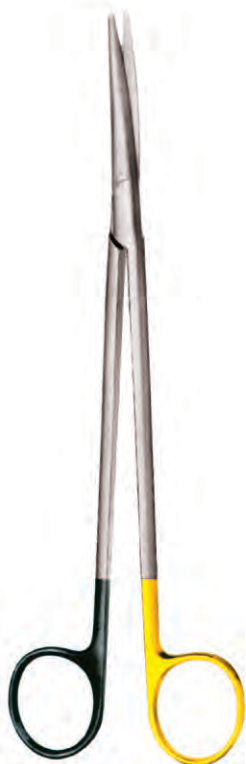
LOCKLIN
 Ai 06-1869-16
 16 cm/6 1/4"
 1 toothed blade



- EN** TC Super-Cut Scissors
- DE** TC Super-Cut Scheren
- ES** Tijeras Super-Cut TC

Page 85 to 86

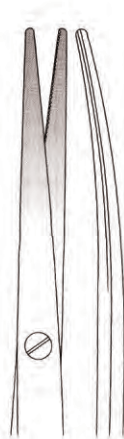




For synthetic suture material
 one toothed cutting edge



Ai 07-1901-14
 14.5 cm/5 3/4"



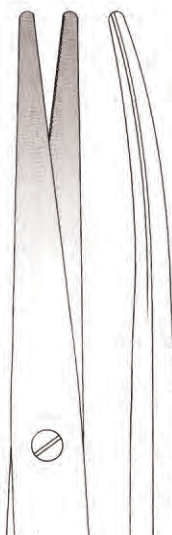
Ai 07-1901-18
 18 cm/7 1/8"



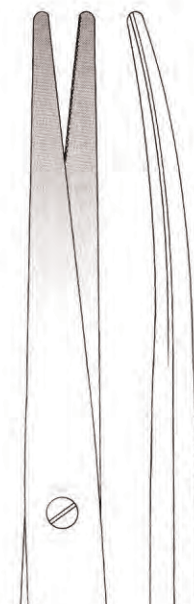
Ai 07-1901-20
 20.5 cm/8 1/8"



Ai 07-1901-23
 23 cm/9"



Ai 07-1901-25
 25 cm/9 7/8"



Ai 07-1901-30
 30 cm/11 3/4"



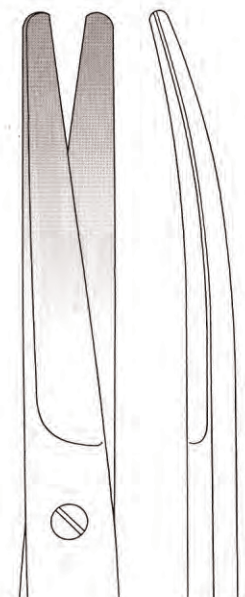
For synthetic suture material
 one toothed cutting edge



Ai 07-1902-14
 14.5 cm/5 3/4"



Ai 07-1902-17
 17 cm/6 3/4"



Ai 07-1902-23
 23 cm/9"



EN

Dressing & Tissue Forceps

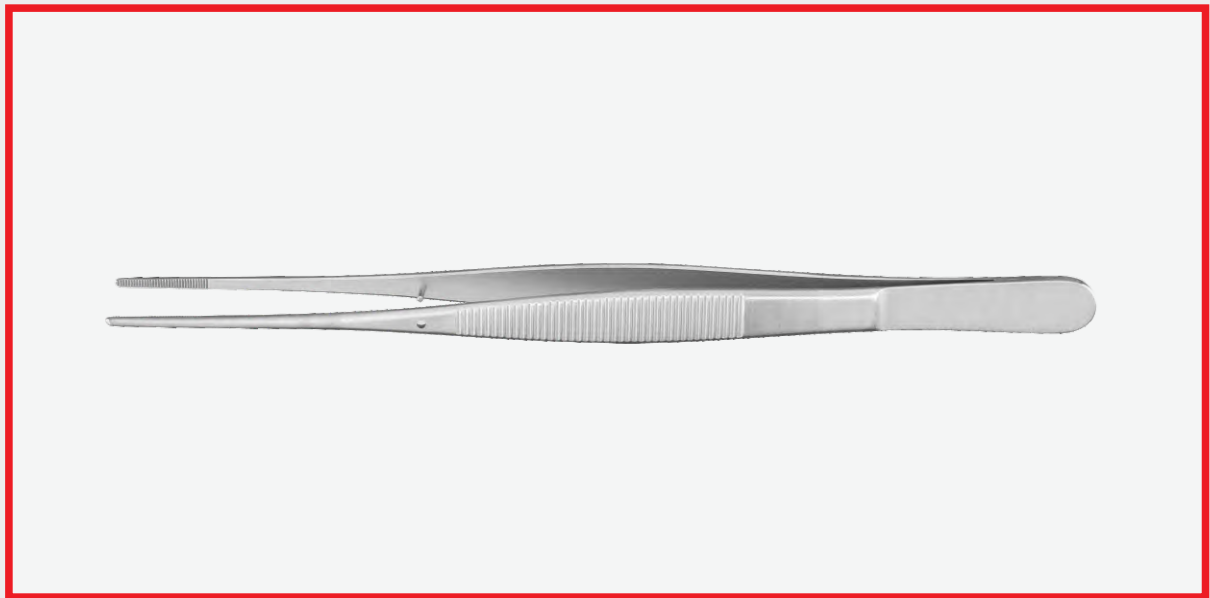
DE

Anatomische und Chirurgische Pinzetten

ES

Pinzas de diseccion con dientes

Page 87 to 110





U.S.A. MODEL

- Ai 08-2001-12 12 cm/4 3/4"
- Ai 08-2001-13 13 cm/5 1/8"
- Ai 08-2001-14 14 cm/5 1/2"
- Ai 08-2001-15 15 cm/5 7/8"
- Ai 08-2001-18 18 cm/7 1/8"
- Ai 08-2001-21 21 cm/8 1/4"
- Ai 08-2001-23 23 cm/9"
- Ai 08-2001-25 25 cm/9 7/8"
- Ai 08-2001-31 31 cm/12 1/4"



GRACILE

- Ai 08-2002-12 12 cm/4 3/4"
- Ai 08-2002-13 13 cm/5 1/8"
- Ai 08-2002-14 14 cm/5 1/2"
- Ai 08-2002-15 15 cm/5 7/8"



ADSON

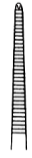
- Ai 08-2003-12 12 cm/4 3/4"
- Ai 08-2003-15 15 cm/5 7/8"



1/2

McINDOE

- Ai 08-2004-15 15 cm/5 7/8"
- Ai 08-2005-15 15.5 cm/6 1/8"



- Ai 08-2006-15 15 cm/5 7/8"
- Ai 08-2007-15 15.5 cm/6 1/8"
- 1 x 2



SEMKEN

- Ai 08-2008-12 12.5 cm/4 7/8"
- Ai 08-2008-15 15 cm/5 7/8"
- Ai 08-2008-18 18 cm/7 1/8"



SEMKEN

- Ai 08-2009-12 12.5 cm/4 7/8"
- Ai 08-2009-15 15 cm/5 7/8"
- Ai 08-2009-18 18 cm/7 1/8"



1/4 Ai 08-2010-17



1/2

TAYLOR

- 17.5 cm/6 7/8"



Ai 08-2011-17



STANDARD
(Narrow Pattern)

- Ai 08-2012-11 11.5 cm/4 1/2"
- Ai 08-2012-13 13 cm/5 1/8"
- Ai 08-2012-14 14 cm/5 1/2"
- Ai 08-2012-16 16 cm/6 1/4"
- Ai 08-2012-18 18 cm/7 1/8"
- Ai 08-2012-20 20 cm/7 7/8"
- Ai 08-2012-23 23 cm/9"
- Ai 08-2012-25 25 cm/9 7/8"
- Ai 08-2012-30 30 cm/11 3/4"



STANDARD
(Straight)

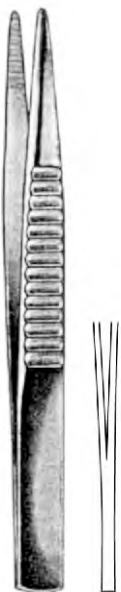
- Ai 08-2013-13 13 cm/5 1/8"
- Ai 08-2013-14 14 cm/5 1/2"
- Ai 08-2013-16 16 cm/6 1/4"

- Ai 08-2014-10 10.5 cm/4 1/8"
- Ai 08-2014-11 11.5 cm/4 1/2"
- Ai 08-2014-13 13 cm/5 1/8"
- Ai 08-2014-14 14 cm/5 1/2"
- Ai 08-2014-16 16 cm/6 1/4"
- Ai 08-2014-18 18 cm/7 1/8"
- Ai 08-2014-20 20 cm/7 7/8"
- Ai 08-2014-23 23 cm/9"
- Ai 08-2014-25 25 cm/9 7/8"
- Ai 08-2014-30 30 cm/11 3/4"



STANDARD
(Curved)

- Ai 08-2015-11 11.5 cm/4 1/2"
- Ai 08-2015-13 13 cm/5 1/8"
- Ai 08-2015-14 14 cm/5 1/2"
- Ai 08-2015-16 16 cm/6 1/4"
- Ai 08-2015-18 18 cm/7 1/8"
- Ai 08-2015-20 20 cm/7 7/8"
- Ai 08-2015-23 23 cm/9"



ENGL. MODELL

- Ai 08-2016-12 12.5 cm/4 7/8"
- Ai 08-2016-15 15.5 cm/6 1/8"



ENGL. MODELL

- Ai 08-2017-13 13 cm/5 1/8"
- Ai 08-2017-14 14.5 cm/5 3/4"



STANDARD

- Ai 08-2018-13 13 cm/5 1/8"
- Ai 08-2018-14 14 cm/5 1/2"

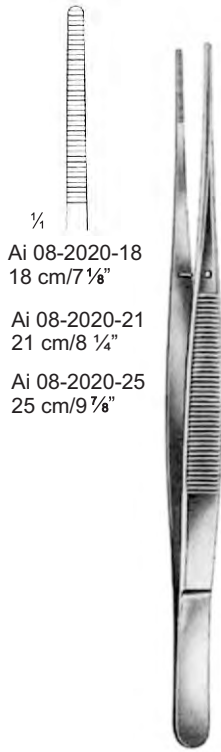


1/2

STILLE

- Ai 08-2019-15 15 cm/5 7/8"





¼
Ai 08-2020-18
18 cm/7 1/8"
Ai 08-2020-21
21 cm/8 1/4"
Ai 08-2020-25
25 cm/9 7/8"

POTTS-SMITH



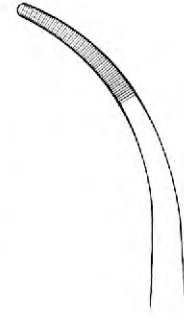
¼
Ai 08-2021-18
18 cm/7 1/8"
Ai 08-2021-21
21 cm/8 1/4"
Ai 08-2021-25
25 cm/9 7/8"



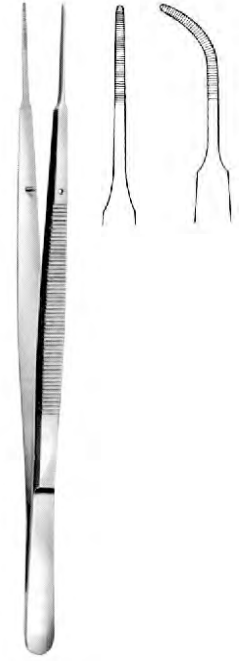
½
BROPHY



¼
Ai 08-2022-20
20 cm/7 7/8"



Ai 08-2023-20
20 cm/7 7/8"



GERALD
Serrated
Ai 08-2024-18 Str
Ai 08-2025-18 Cvd
18 cm/7 1/8"

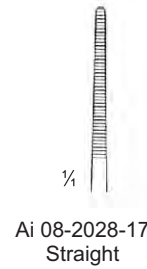


¼
TAYLOR
Ai 08-2026-17
17.5 cm/6 7/8"

with
dissector



¼
TAYLOR
Dissector end
Ai 08-2027-17
17.5 cm/6 7/8"



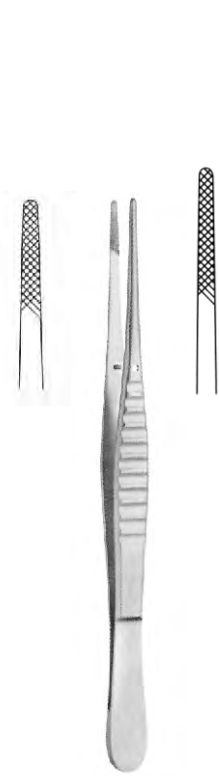
¼
Ai 08-2028-17
Straight



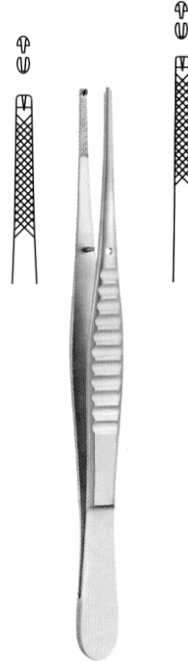
Ai 08-2029-17
Curved



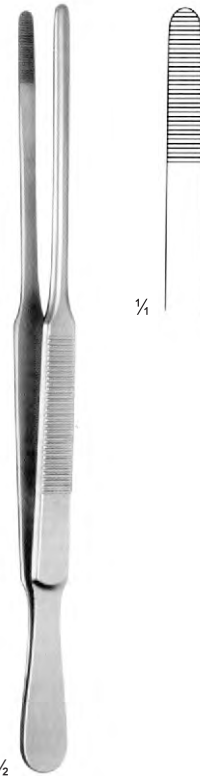
CUSHING
17.5 cm/6 7/8"



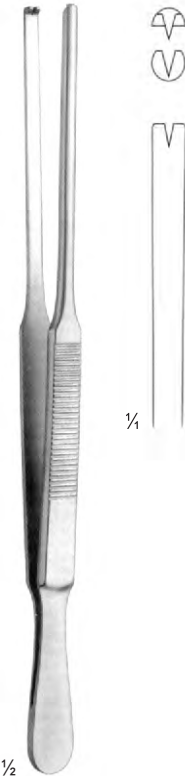
WAUGH
Ai 08-2030-15 15 cm/5 7/8"
Ai 08-2030-20 20 cm/7 7/8"



WAUGH
Ai 08-2031-15 15 cm/5 7/8"
Ai 08-2031-20 20 cm/7 7/8"
1 x 2 teeth



DUEHRSSSEN
Ai 08-2032-20 20 cm/7 7/8"



DUEHRSSSEN
Ai 08-2033-20 20 cm/7 7/8"



LEEDS
Ai 08-2034-15 15 cm/5 7/8"
Ai 08-2034-17 17 cm/6 3/4"
Ai 08-2034-20 20 cm/7 7/8"
Ai 08-2034-25 25 cm/9 7/8"



LEEDS
Ai 08-2035-15 15 cm/5 7/8"
Ai 08-2035-17 17 cm/6 3/4"
Ai 08-2035-20 20 cm/7 7/8"



RAMSEY
Ai 08-2037-18 18 cm/7 1/8"
1 x 2 Teeth



Ai 08-2036-18 18 cm/7 7/8"



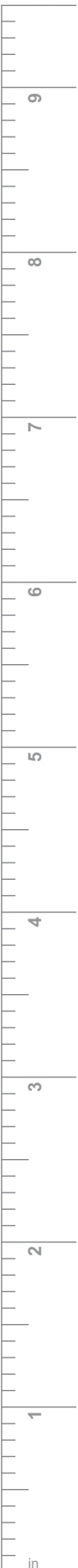
1/4



Ai 08-2038-18 18 cm/7 1/8"
2 x 3 Teeth



MAINGOT
Ai 08-2039-28 28 cm/11"





EVANS McINDOE
 Ai 08-2040-15
 15 cm/5 7/8"



FISCHL
 Ai 08-2041-15
 15 cm/5 7/8"



Ai 08-2042-25
 25 cm/9 7/8"



Ai 08-2043-30
 30 cm/11 3/4"



LLANDOUGH
 Ai 08-2044-15
 15 cm/5 7/8"



BARSKY
 Ai 08-2045-15
 15 cm/5 7/8"



BARSKY
 Ai 08-2046-18
 18 cm/7 1/8"



WANGENSTEEN
 Ai 08-2047-23
 23 cm/9"



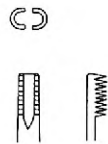
DOTT
 Ai 08-2048-18
 18 cm/7 1/8"



PYRAH
 3 x 4
 Ai 08-2049-23
 23 cm/9"



BROWN
 Ai 08-2050-15 15 cm/5 7/8"
 Ai 08-2050-20 20 cm/7 7/8"



MILES
 3 x 4
 Ai 08-2051-25
 25 cm/9 7/8"

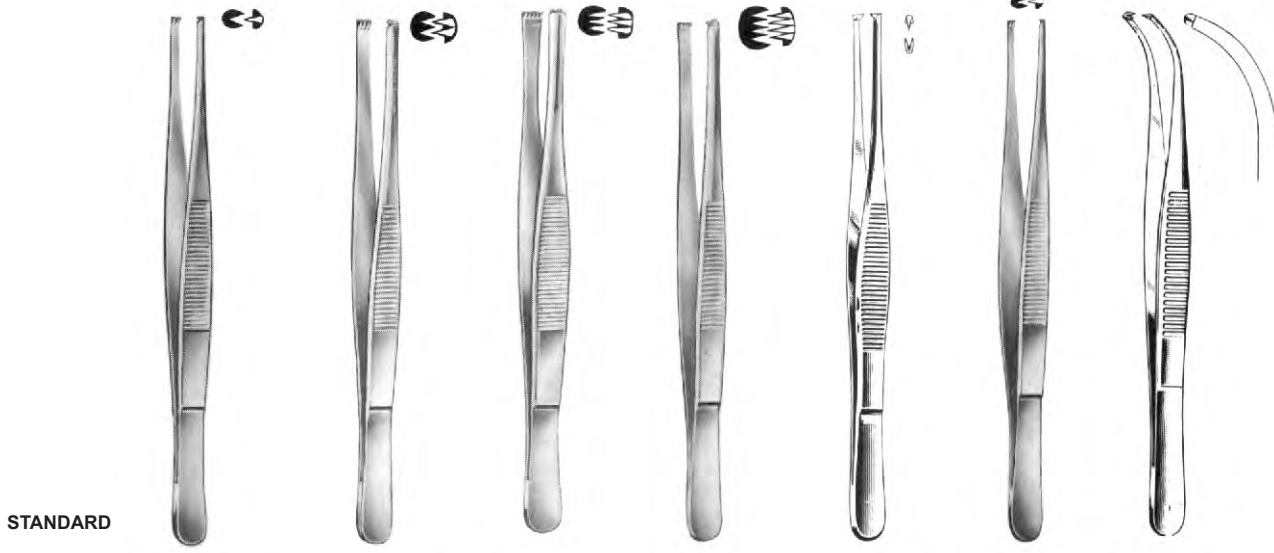


MILLIN
 3 x 4
 Ai 08-2052-23
 23 cm/9"



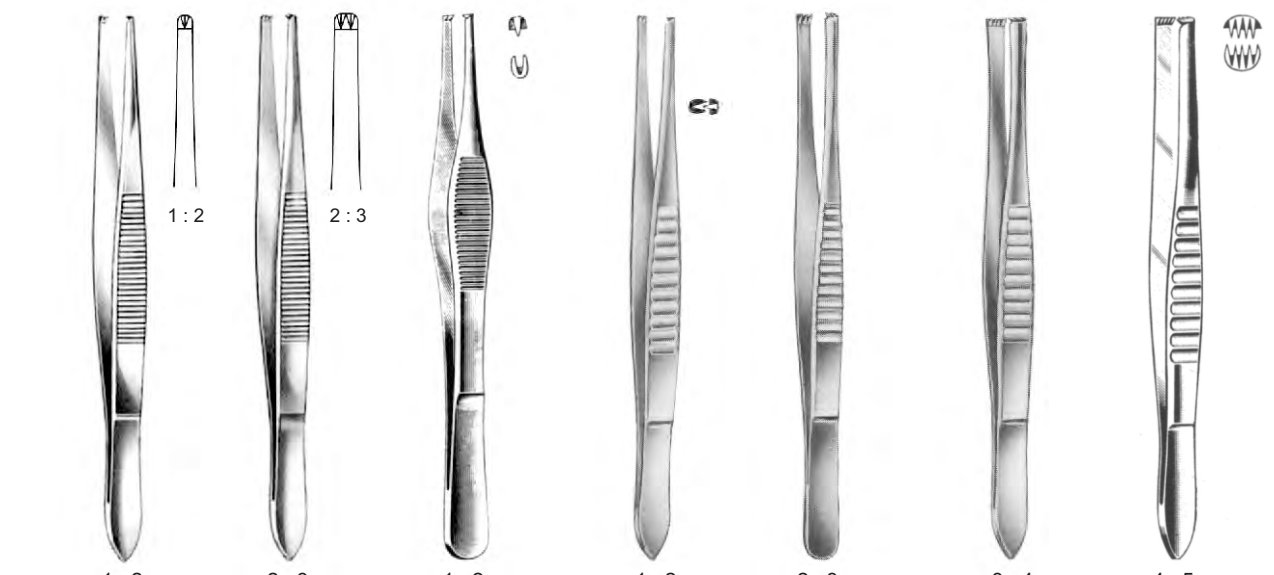
THOMSON - WALKER
 1 x 2
 Ai 08-2053-19
 19 cm/7 1/2"



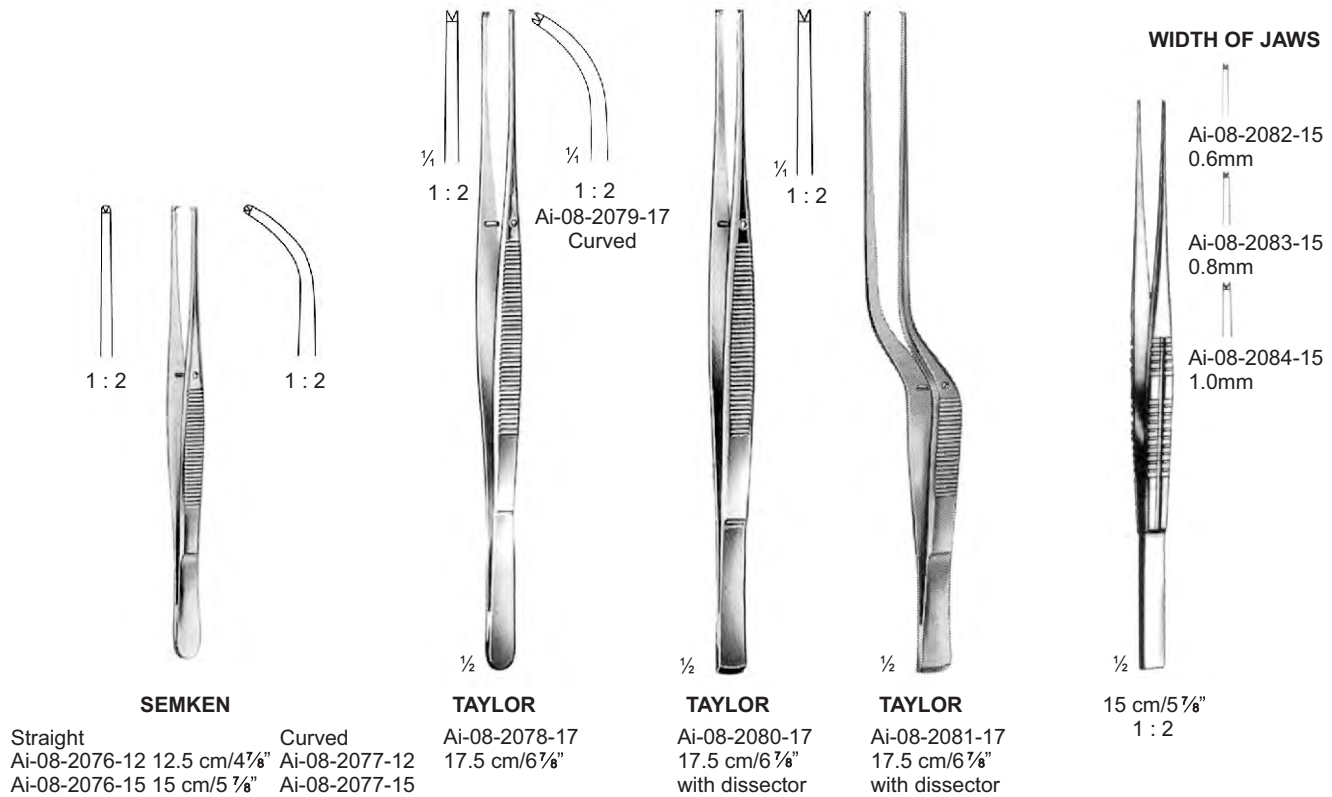
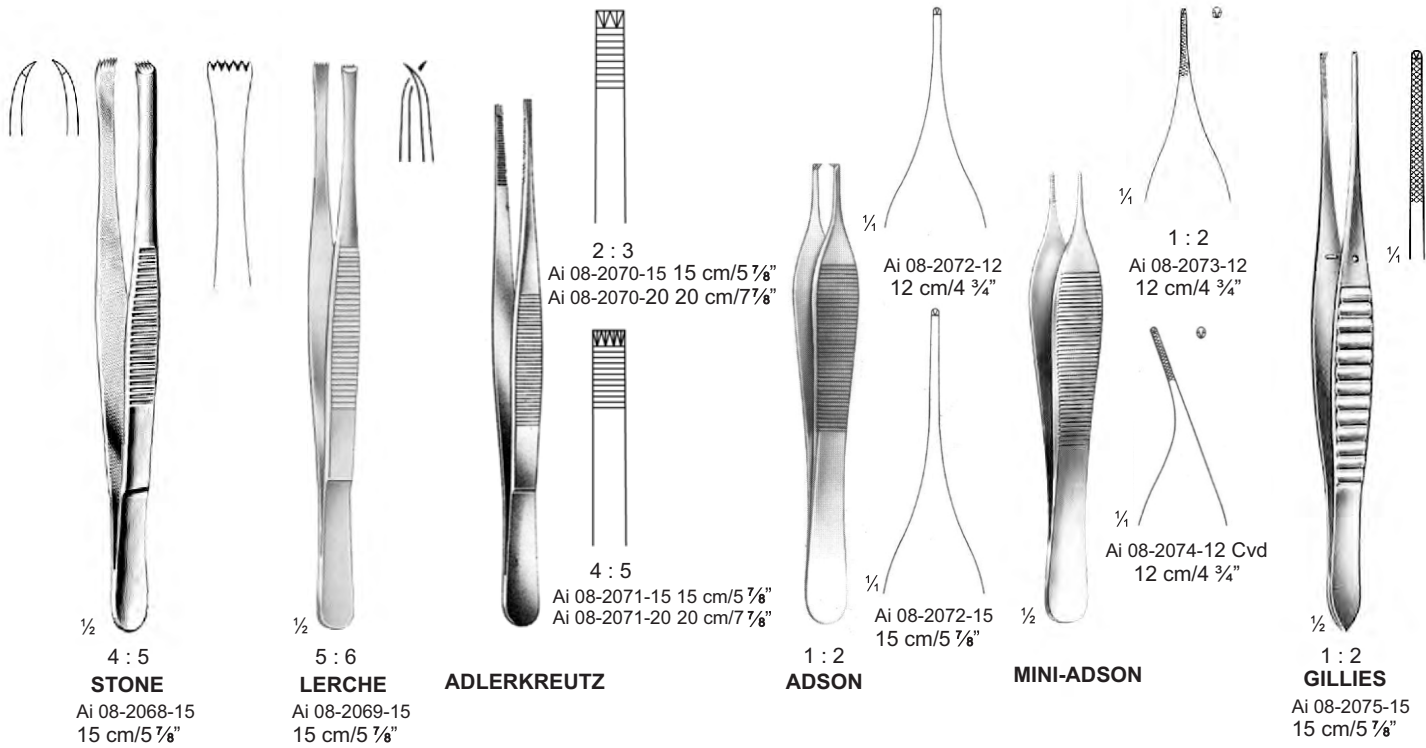


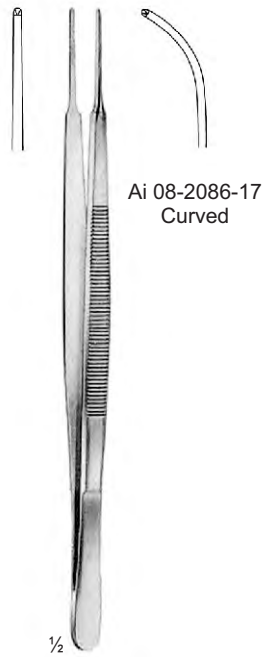
STANDARD

cm	in	1 : 2	2 : 3	3 : 4	4 : 5	1 : 2	1 : 2 narrow	1 : 2 curved
10.5	4 1/8"	Ai 08-2054-10						
11.5	4 1/2"	Ai 08-2054-11	Ai 08-2055-11					
13.0	5 1/8"	Ai 08-2054-13	Ai 08-2055-13	Ai 08-2056-13	Ai 08-2057-13	Ai 08-2058-13	Ai 08-2059-13	Ai 08-2060-13
14.5	5 3/4"	Ai 08-2054-14	Ai 08-2055-14	Ai 08-2056-14	Ai 08-2057-14	Ai 08-2058-14	Ai 08-2059-14	Ai 08-2060-14
16.0	6 1/4"	Ai 08-2054-16	Ai 08-2055-16	Ai 08-2056-16	Ai 08-2057-16	Ai 08-2058-16	Ai 08-2059-16	
18.0	7 1/8"	Ai 08-2054-18	Ai 08-2055-18			Ai 08-2058-18	Ai 08-2059-18	
20.0	7 7/8"	Ai 08-2054-20	Ai 08-2055-20			Ai 08-2058-20		
23.0	9"	Ai 08-2054-23						
25.0	9 7/8"	Ai 08-2054-25	Ai 08-2055-25					
30.0	11 3/4"	Ai 08-2054-30	Ai 08-2055-30					



cm	in	1 : 2 STILLE	2 : 3 STILLE	1 : 2	1 : 2 MOD. USA	2 : 3 MOD. USA	3 : 4	4 : 5
12.0	4 3/4"				Ai 08-2064-12	Ai 08-2065-12		
13.0	5 1/8"			Ai 08-2063-13	Ai 08-2064-13	Ai 08-2065-13	Ai 08-2066-13	Ai 08-2067-13
14.5	5 3/4"			Ai 08-2063-14	Ai 08-2064-14	Ai 08-2065-14	Ai 08-2066-14	Ai 08-2067-14
15.0	5 7/8"	Ai 08-2061-15	Ai 08-2062-15					
15.5	6 1/8"			Ai 08-2064-15	Ai 08-2065-15	Ai 08-2066-15	Ai 08-2067-15	
18.5	7 1/4"			Ai 08-2064-18	Ai 08-2065-18			
21.0	8 1/4"			Ai 08-2064-21	Ai 08-2065-21			
25.0	9 7/8"			Ai 08-2064-25	Ai 08-2065-25			
31.0	12 1/4"			Ai 08-2064-31	Ai 08-2065-31			

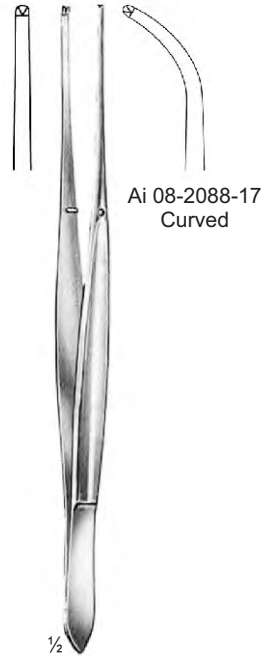




Ai 08-2086-17
Curved

1/2

GERALD
1 : 2
Ai 08-2085-17
17 cm/6 3/4"



Ai 08-2088-17
Curved

1/2

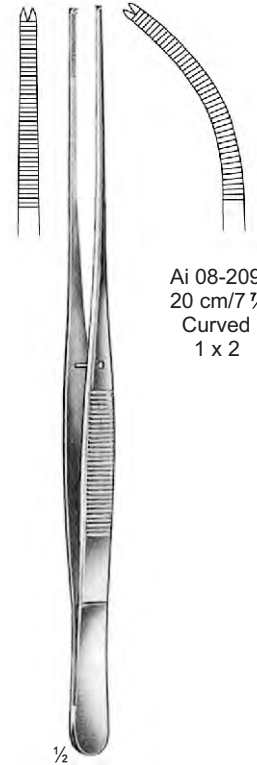
CUSHING
1 : 2
Ai 08-2087-17
17 cm/6 3/4"



Ai 08-2090-18 18 cm/7 1/8"
 Ai 08-2090-21 21 cm/8 1/4"
 Ai 08-2090-25 25 cm/9 7/8"

POTTS-SMITH

Ai 08-2089-18 18 cm/7 1/8"
 Ai 08-2089-21 21 cm/8 1/4"
 Ai 08-2089-25 25 cm/9 7/8"



Ai 08-2092-20
20 cm/7 7/8"
Curved
1 x 2

1/2

BROPHY
1 x 2
Ai 08-2091-20
20 cm/7 7/8"



7 : 7

ADSON-BROWN
Ai 08-2093-12
12 cm/4 3/4"



MICRO-ADSON



Ai 08-2094-12
12 cm/4 3/4"



Ai 08-2095-15
15 cm/5 7/8"



MICRO-ADSON

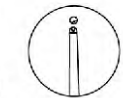
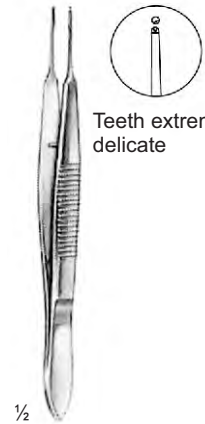


Ai 08-2096-12
12 cm/4 3/4"



Ai 08-2097-15
15 cm/5 7/8"

1 : 2



Teeth extremely delicate

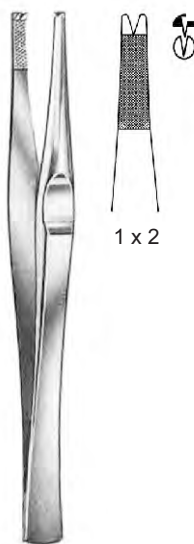
Ai 08-2098-11
11 cm/4 1/2"





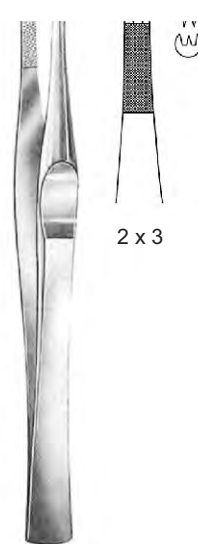
TREVES

Ai 08-2099-13 13 cm/5 1/8"
Ai 08-2099-15 15 cm/5 7/8"



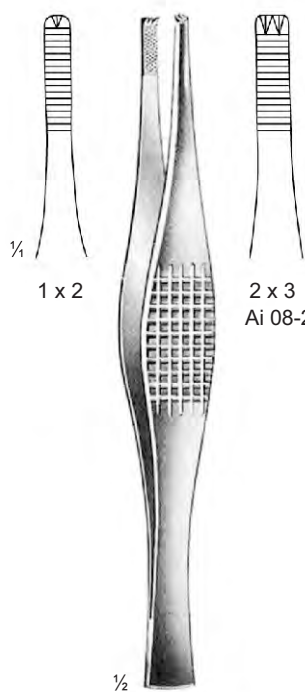
LANE

Ai 08-2100-14 14 cm/5 1/2"
Ai 08-2100-20 20 cm/7 7/8"



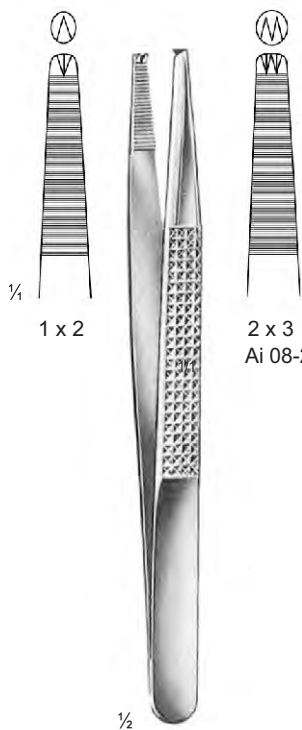
LANE

Ai 08-2101-14 14 cm/5 1/2"
Ai 08-2101-20 20 cm/7 7/8"



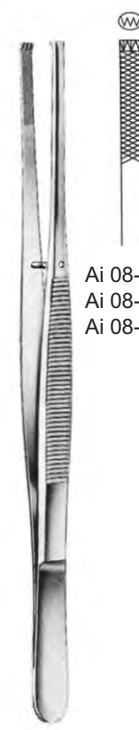
FERRIS-SMITH

Ai 08-2102-18
18 cm/7 1/8"



BONNEY

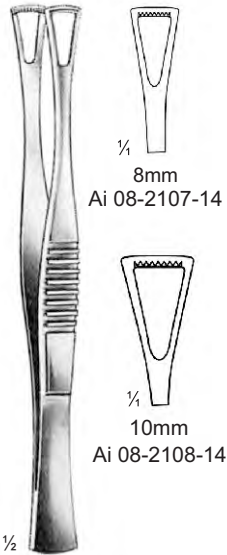
Ai 08-2104-18
18 cm/7 1/8"



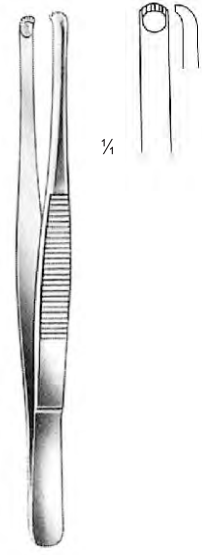
STILLE-BARRAYA

Ai 08-2106-18 18 cm/7 1/8"
Ai 08-2106-20 20 cm/7 7/8"
Ai 08-2106-25 25 cm/9 7/8"





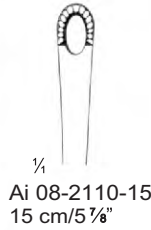
DUVAL
14.5 cm/5 3/4"



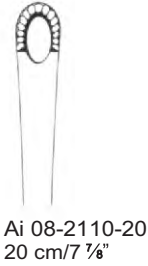
DURANTE
 Ai 08-2109-14 14.5 cm/5 3/4"
 Ai 08-2109-16 16 cm/6 1/4"
 Ai 08-2109-20 20 cm/7 7/8"



RUSS. MODELL



Ai 08-2110-15
15 cm/5 7/8"



Ai 08-2110-20
20 cm/7 7/8"



Ai 08-2110-25
25 cm/9 7/8"



COLLIN-DUVAL
20 cm/7 7/8"



Fig. 1
Ai 08-2111-14
14 mm



Fig. 2
Ai 08-2111-18
18 mm

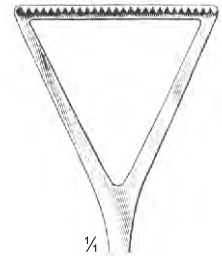


Fig. 3
Ai 08-2111-27
27 mm



NELSON
 Ai 08-2112-15
15 cm/5 7/8"
 Ai 08-2112-23
23 cm/9"



DAVIS
 Ai 08-2113-25
25 cm/9 7/8"



MAYO-RUSS
 Ai 08-2114-23
23 cm/9"



SINGLEY-TUTTLE
 Ai 08-2115-23
23 cm/9"



LEEDS

1 x 2

Ai 08-2116-15 15 cm/5⁷/₈"
 Ai 08-2116-17 17 cm/6 ³/₄"
 Ai 08-2116-20 20 cm/7⁷/₈"



LEEDS

2 x 3

Ai 08-2117-15
 15 cm/5⁷/₈"

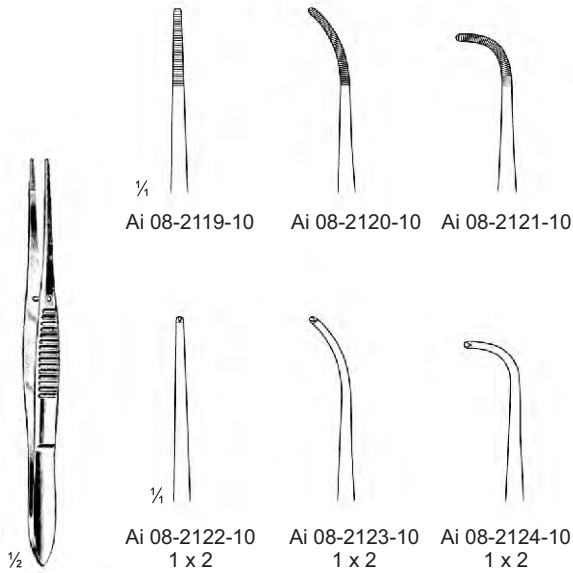


JEAN

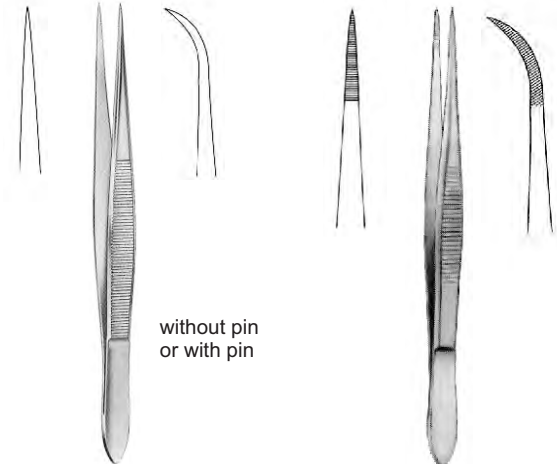
1 x 2

Ai 08-2118-14 14 cm/5 ¹/₂"
 Ai 08-2118-18 18 cm/7¹/₈"

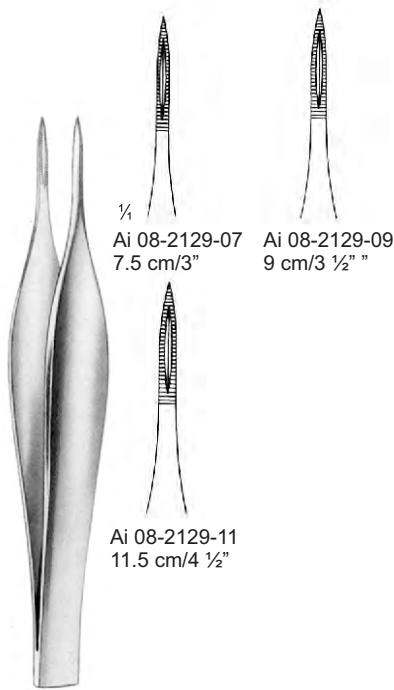




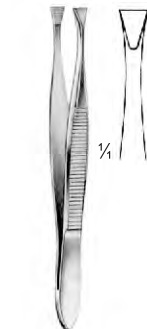
GRAEFE-IRIS
10.5 cm/4 1/8"



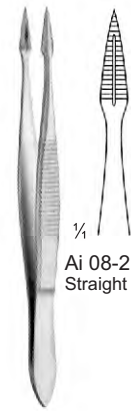
	Smooth	Serrated		
8 cm/3 1/4"	Ai 08-2125-08	Ai 08-2126-08	Ai 08-2127-08	Ai 08-2128-08
9 cm/3 1/2"	Ai 08-2125-09	Ai 08-2126-09	Ai 08-2127-09	Ai 08-2128-09
10.5 cm/4 1/8"	Ai 08-2125-10	Ai 08-2126-10	Ai 08-2127-10	Ai 08-2128-10
11.5 cm/4 1/2"	Ai 08-2125-11	Ai 08-2126-11	Ai 08-2127-11	Ai 08-2128-11
12.5 cm/4 7/8"	Ai 08-2125-12	Ai 08-2126-12	Ai 08-2127-12	Ai 08-2128-12



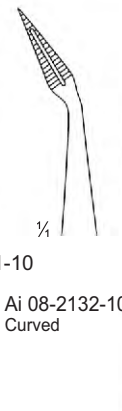
FEILCHENFELD



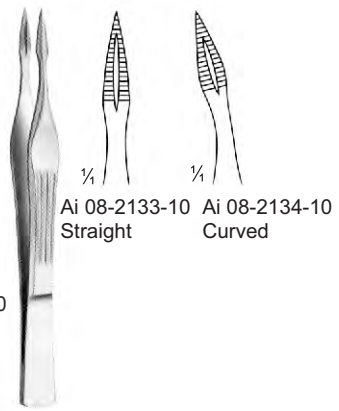
HUNTER
8.5 cm/3 3/8"
Littauer

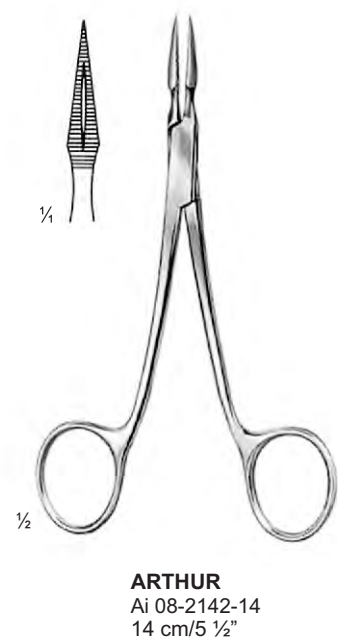
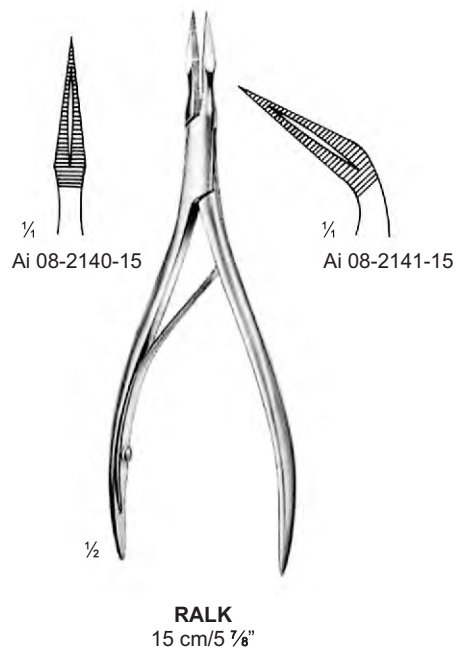
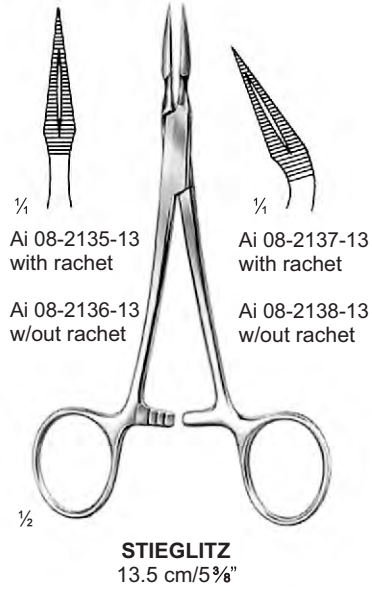


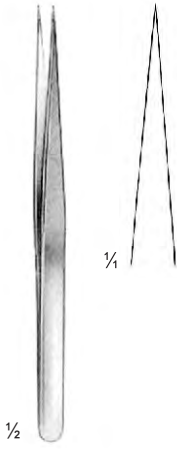
HUNTER
10.5 cm/4 1/8"



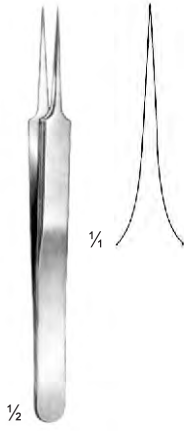
WALTER-CARMALT
10.5 cm/4 1/8"



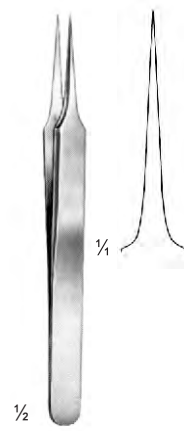




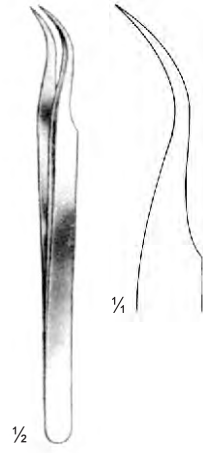
Ai 08-2143-11
No. 3
11.5 cm/4 1/2"



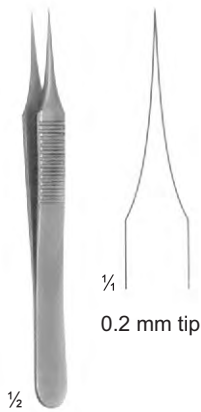
Ai 08-2144-11
No. 4
11 cm/4 1/2"



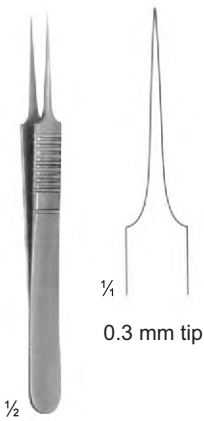
Ai 08-2145-11
No. 5
11 cm/4 1/2"



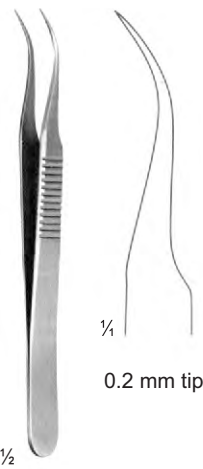
Ai 08-2146-11
No. 7
11.5 cm/4 1/2"



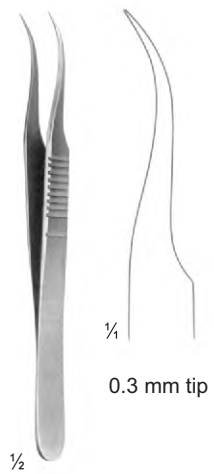
Ai 08-2147-10
10.5 cm/4 1/8"



Ai 08-2148-10
10.5 cm/4 1/8"



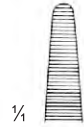
Ai 08-2149-11
11.5 cm/4 1/2"



Ai 08-2150-11
11.5 cm/4 1/2"



DIEFFENBACH



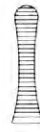
¼
 Ai 08-2151-06
 6 cm/2 ¼"



Ai 08-2152-06
 6 cm/2 ¼"



¼
 Ai 08-2153-03
 3.5 cm/1 ¾"



Ai 08-2154-05
 5 cm/2"



Ai 08-2155-03
 3.5 cm/1 ¾"



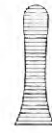
Ai 08-2156-05
 5 cm/2"



¼
 Ai 08-2157-03
 3.8 cm/1 ½"



Ai 08-2157-04
 4.5 cm/1 ¾"



Ai 08-2157-05
 5.5 cm/2 ½"



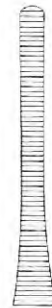
DIEFFENBACH



¼
 Ai 08-2157-06
 6.5 cm/2 ½"



Ai 08-2157-07
 7 cm/2 ¾"

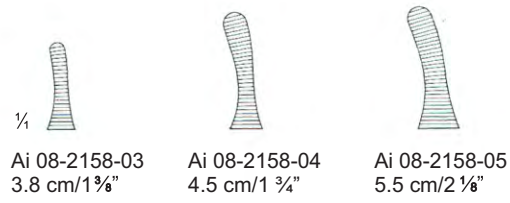


Ai 08-2157-08
 7.5 cm/3"

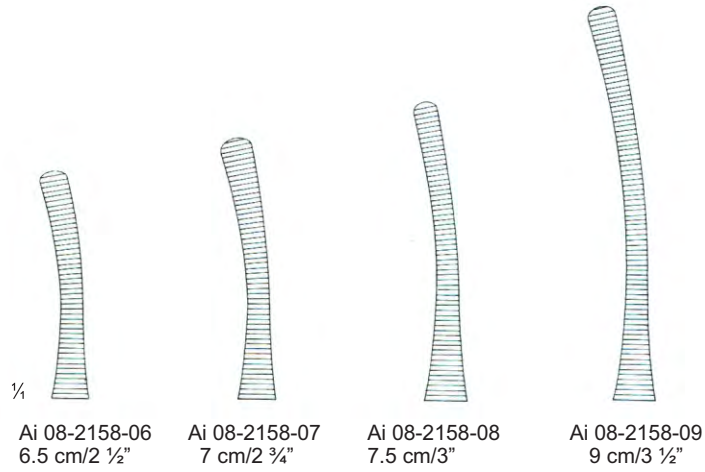


Ai 08-2157-09
 9 cm/3 ½"

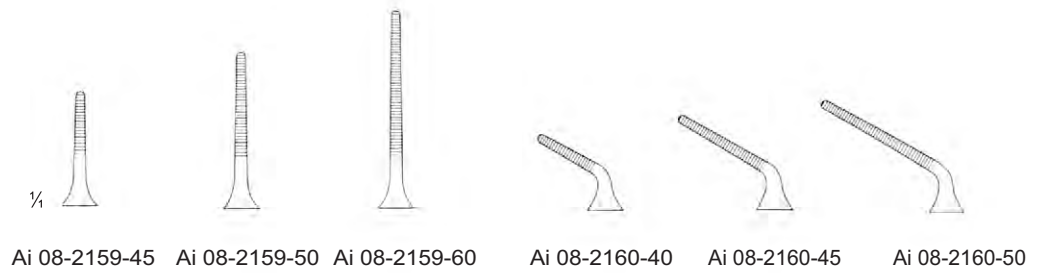




JOHNS-HOPKINS



DIETRICH



Length	45 mm	50 mm	60 mm	40 mm	45 mm	50 mm
Jaw Length	8 mm	12 mm	20 mm	8 mm	12 mm	20 mm
Closing Pressure	50 gr	50 gr	50 gr	50 gr	50 gr	50 gr
Weight	3 gr	3 gr	3 gr	3 gr	3 gr	3 gr

ATRAUMA



Ai 08-2161-45 Ai 08-2161-50 Ai 08-2161-60 Ai 08-2162-35 Ai 08-2162-45 Ai 08-2162-50

Length	45 mm	50 mm	60 mm	35 mm	45 mm	50 mm
Jaw Length	10 mm	14 mm	20 mm	10 mm	14 mm	20 mm
Closing Pressure	180 gr	180 gr	180 gr	180 gr	180 gr	180 gr
Weight	3 gr	3 gr	3 gr	3 gr	3 gr	3 gr

DE BAKEY-DIETRICH



JOHNS-HOPKINS
 Ai 08-2163-05 5 cm/2"
 Ai 08-2163-06 6.5 cm/2 1/2"
 Ai 08-2163-07 7.5 cm/3"

JOHNS-HOPKINS
 Ai 08-2164-05 5 cm/2"
 Ai 08-2164-06 6.5 cm/2 1/2"
 Ai 08-2164-07 7.5 cm/3"

HESS L
 Ai 08-2165-20 20 mm
 Ai 08-2165-30 30 mm





ATRAUMA



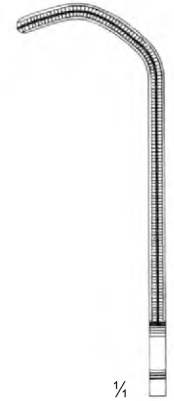
Ai 08-2166-07
7 cm/2 3/4"

DEBAKEY-SATINSKY



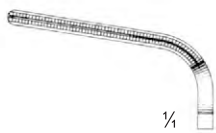
Ai 08-2167-09
9 cm/3 1/2"

DEBAKEY-SATINSKY



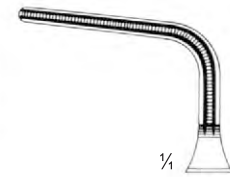
Ai 08-2168-10
10 cm/3 1/8"

DEBAKEY-SATINSKY



Ai 08-2169-06
6 cm/2 1/4"

GLOVER



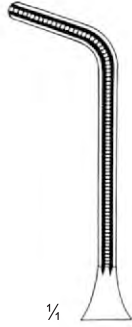
Ai 08-2170-07
7 cm/2 3/4"

SANTULLI

ATRAUMA



GREGORY SOFT
Carotid Clamp



Ai 08-2171-09
9 cm/3 1/2"



Ai 08-2171-11
11 cm/4 3/8"



GREGORY
Carotid Clamp



Ai 08-2172-10
10.5 cm/4 1/8"
Right



Ai 08-2173-10
10.5 cm/4 1/8"
Left





ATRAUMA



DEBAKEY



Ai 08-2174-07
7.5 cm/3"



Ai 08-2174-08
8.5 cm/3 3/8"



Ai 08-2174-10
10 cm/3 7/8"



Ai 08-2174-12
12 cm/4 3/4"



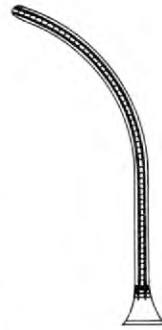
DEBAKEY



Ai 08-2175-07
7.5 cm/3"



Ai 08-2175-08
8.5 cm/3 3/8"



Ai 08-2175-09
9.5 cm/3 7/8"



Ai 08-2175-11
11 cm/4 3/8"

ATRAUMA



GLOVER



Ai 08-2176-07
7 cm/2 3/4"



Ai 08-2176-08
7.5 cm/3"



Ai 08-2176-09
9 cm/3 1/2"



Ai 08-2176-11
11 cm/4 3/8"



GLOVER



Ai 08-2177-06
6.5 cm/2 1/2"



Ai 08-2177-07
7 cm/2 3/4"

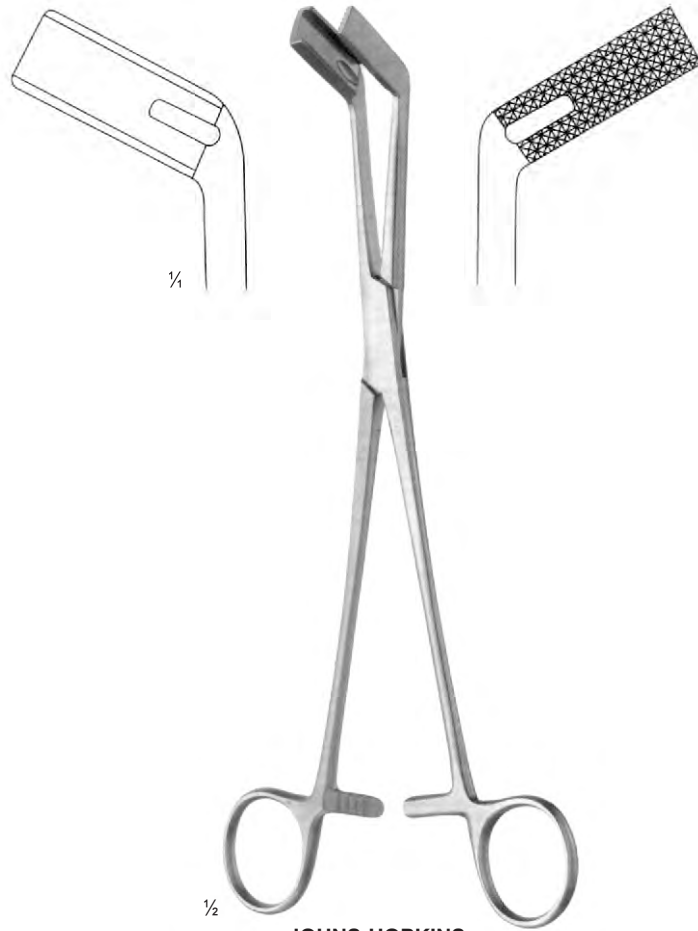


Ai 08-2177-08
8.5 cm/3 3/8"



Ai 08-2177-10
10.5 cm/4 1/8"

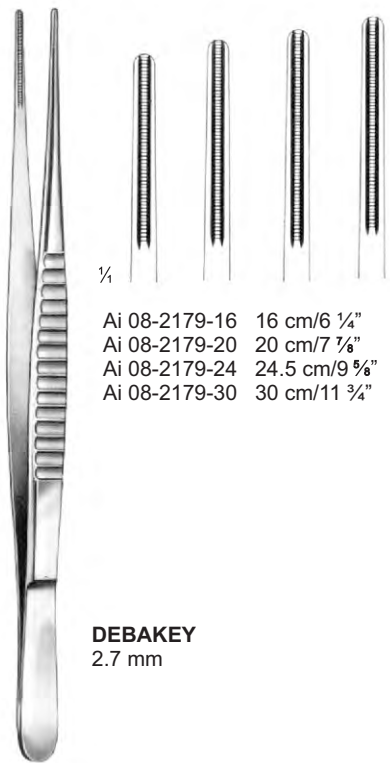



 $\frac{1}{2}$

JOHNS-HOPKINS
 Ai 08-2178-24
 24.5 cm/9 $\frac{3}{8}$ "

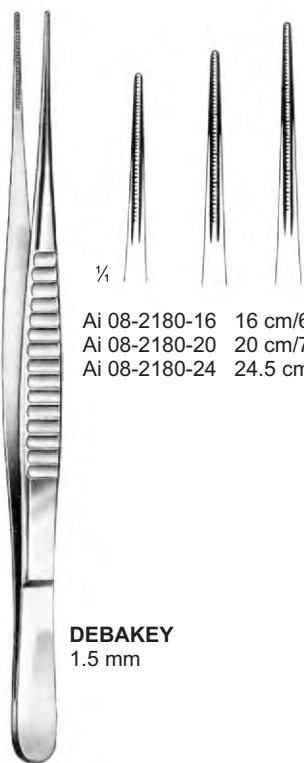
Applying forceps for Johns-Hopkins
 and DeBakey Bulldog clamps

ATRAUMA



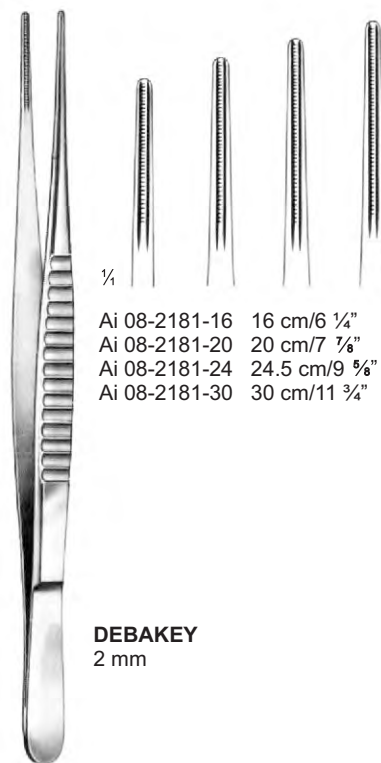
- ¼
- Ai 08-2179-16 16 cm/6 ¼"
 - Ai 08-2179-20 20 cm/7 ⅞"
 - Ai 08-2179-24 24.5 cm/9 ⅝"
 - Ai 08-2179-30 30 cm/11 ¾"

DEBAKEY
2.7 mm



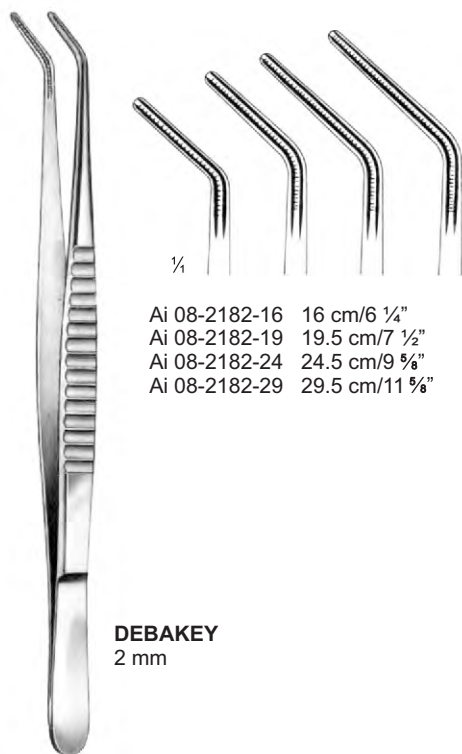
- ¼
- Ai 08-2180-16 16 cm/6 ¼"
 - Ai 08-2180-20 20 cm/7 ⅞"
 - Ai 08-2180-24 24.5 cm/9 ⅝"

DEBAKEY
1.5 mm



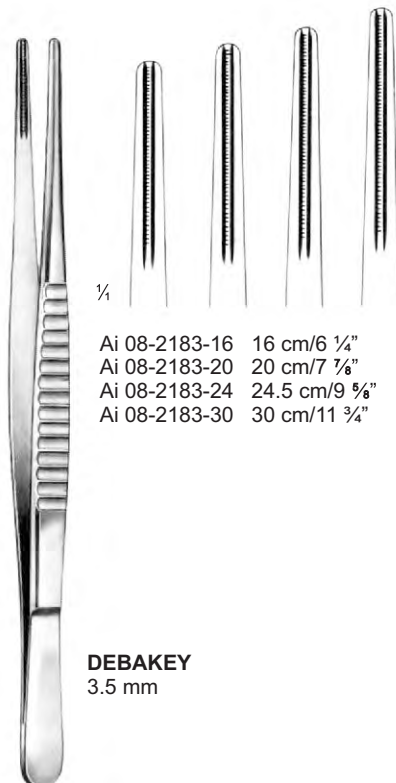
- ¼
- Ai 08-2181-16 16 cm/6 ¼"
 - Ai 08-2181-20 20 cm/7 ⅞"
 - Ai 08-2181-24 24.5 cm/9 ⅝"
 - Ai 08-2181-30 30 cm/11 ¾"

DEBAKEY
2 mm



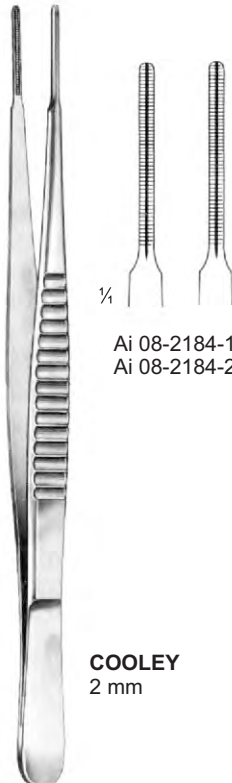
- ¼
- Ai 08-2182-16 16 cm/6 ¼"
 - Ai 08-2182-19 19.5 cm/7 ½"
 - Ai 08-2182-24 24.5 cm/9 ⅝"
 - Ai 08-2182-29 29.5 cm/11 ⅝"

DEBAKEY
2 mm



- ¼
- Ai 08-2183-16 16 cm/6 ¼"
 - Ai 08-2183-20 20 cm/7 ⅞"
 - Ai 08-2183-24 24.5 cm/9 ⅝"
 - Ai 08-2183-30 30 cm/11 ¾"

DEBAKEY
3.5 mm



- ¼
- Ai 08-2184-16 16 cm/6 ¼"
 - Ai 08-2184-20 20 cm/7 ⅞"

COOLEY
2 mm



EN TC Forceps

DE TC-Zange

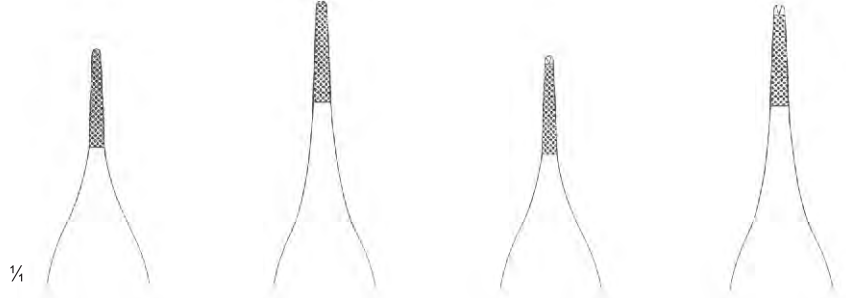
ES Pinzas TC

Page 111 to 114





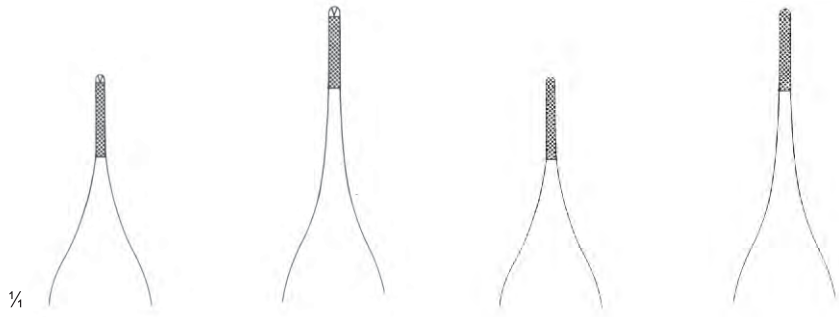
ADSON



Ai 09-2301-12 12 cm/4 3/4" 0.4 mm
 Ai 09-2301-15 15 cm/5 7/8" 0.4 mm
 Ai 09-2302-12 12 cm/4 3/4" 1 x 2 0.4 mm
 Ai 09-2302-15 15 cm/5 7/8" 1 x 2 0.4 mm



MICRO ADSON



Ai 09-2303-12 12 cm/4 3/4" 1 x 2 0.3 mm
 Ai 09-2303-15 15 cm/5 7/8" 1 x 2 0.3 mm
 Ai 09-2304-12 12 cm/4 3/4" 0.3 mm
 Ai 09-2304-15 15 cm/5 7/8" 0.3 mm



ADSON BROWN
Ai 09-2305-12 12 cm/4 3/4"





STANDARD

- Ai 09-2306-14 14.5 cm/5 3/4"
- Ai 09-2306-16 16 cm/6 1/4"
- Ai 09-2306-18 18 cm/7 1/8"
- Ai 09-2306-20 20 cm/7 7/8"
- Ai 09-2306-25 25 cm/9 3/8"
- Ai 09-2306-30 30 cm/11 3/4"



OEHLER

- 1/4
Ai 09-2307-14 14.5 cm/5 3/4" 0.5 mm
- 1/4
Ai 09-2307-16 16 cm/6 1/4" 0.5 mm
- 1/4
Ai 09-2307-18 18 cm/7 1/8" 0.5 mm
- 1/4
Ai 09-2307-20 20 cm/7 7/8" 0.5 mm
- 1/4
Ai 09-2307-25 25 cm/9 3/8" 0.5 mm



USA MOD.
15 cm/5 7/8"



CUSHING
17.5 cm 6 7/8"



CUSHING-TAYLOR
18 cm/7 1/8"



EN Titanium Forceps

DE Titan-Pinzetten

ES Pinzas de titanio

Page 115 to 116



ATRAUMA

TITANIUM



Ai 10-2401-00
 Vena
 Closing pressure
 110 +/- 10 gr

Ai 10-2402-00
 Vena
 Closing pressure
 110 +/- 10 gr

Ai 10-2403-00
 Vena
 Closing pressure
 110 +/- 10 gr

Ai 10-2404-00
 Vena
 Closing pressure
 110 +/- 10 gr

	Arteria	Arteria	Arteria	Arteria
Closing Pressure	220 +/- 10 gr	220 +/- 10 gr	220 +/- 10 gr	220 +/- 10 gr
Length	30 mm	35 mm	40 mm	50 mm
Jaw Length	9 mm	13 mm	14 mm	23 mm
Weight	1 gr	1 gr	1 gr	1.5 gr



Ai 10-2405-00
 Vena
 Closing pressure
 110 +/- 10 gr

Ai 10-2406-00
 Vena
 Closing pressure
 110 +/- 10 gr

Ai 10-2407-00
 Vena
 Closing pressure
 110 +/- 10 gr

Ai 10-2408-00
 Vena
 Closing pressure
 110 +/- 10 gr

	Arteria	Arteria	Arteria	Arteria
Closing Pressure	220 +/- 10 gr	220 +/- 10 gr	220 +/- 10 gr	220 +/- 10 gr
Length	30 mm	35 mm	40 mm	50 mm
Jaw Length	9 mm	13 mm	14 mm	23 mm
Weight	1 gr	1 gr	1 gr	1.5 gr



Ai 10-2409-00
 Vena
 Closing pressure
 110 +/- 10 gr

Ai 10-2410-00
 Vena
 Closing pressure
 110 +/- 10 gr

Ai 10-2411-00
 Vena
 Closing pressure
 110 +/- 10 gr

Ai 10-2412-00
 Vena
 Closing pressure
 110 +/- 10 gr

	Arteria	Arteria	Arteria	Arteria
Closing Pressure	220 +/- 10 gr	220 +/- 10 gr	220 +/- 10 gr	220 +/- 10 gr
Length	30 mm	35 mm	40 mm	50 mm
Jaw Length	9 mm	13 mm	14 mm	23 mm
Weight	1 gr	1 gr	1 gr	1.5 gr

ATRAUMA



Ai 10-2413-16
16 cm/6 1/4"
1.5 mm



Ai 10-2413-20
20.5 cm/8 1/8"
1.5 mm



Ai 10-2413-24
24.5 cm/9 5/8"
1.5 mm



Ai 10-2414-16
16 cm/6 1/4"
1.8 mm



Ai 10-2414-20
20.5 cm/8 1/8"
1.8 mm



Ai 10-2414-24
24.5 cm/9 5/8"
1.8 mm

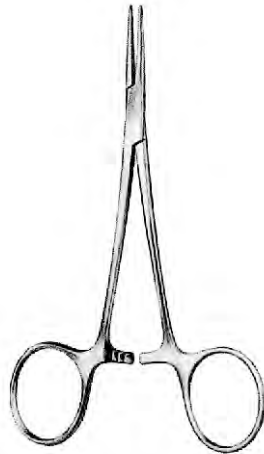
DEBAKEY



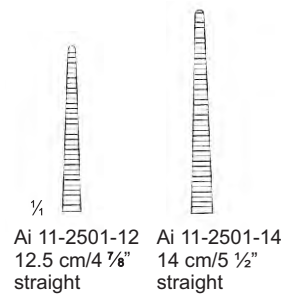
- EN** Artery Forceps
- DE** Arterienklemmen
- ES** Pinzas hemostáticas

Page 117 to 157

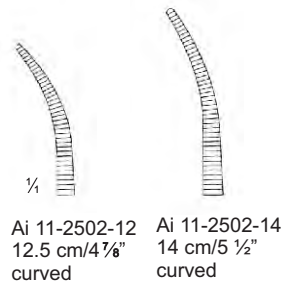




HALSTED-MOSQUITO



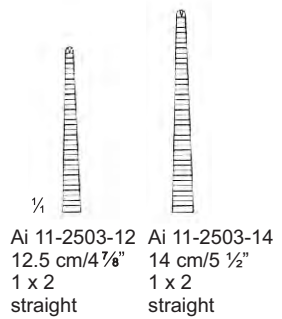
Ai 11-2501-12 12.5 cm/4 7/8" straight
 Ai 11-2501-14 14 cm/5 1/2" straight



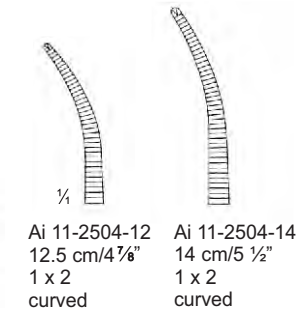
Ai 11-2502-12 12.5 cm/4 7/8" curved
 Ai 11-2502-14 14 cm/5 1/2" curved



HALSTED-MOSQUITO

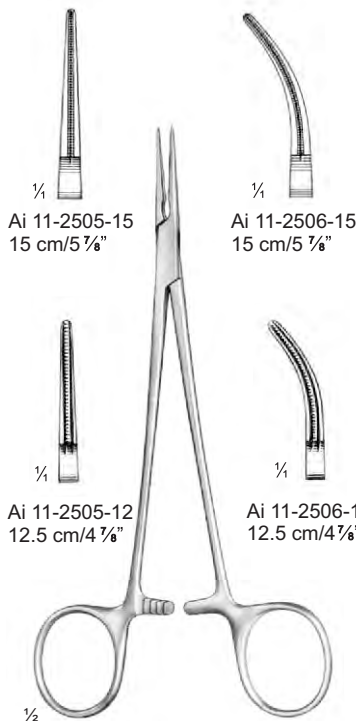


Ai 11-2503-12 12.5 cm/4 7/8" 1 x 2 straight
 Ai 11-2503-14 14 cm/5 1/2" 1 x 2 straight



Ai 11-2504-12 12.5 cm/4 7/8" 1 x 2 curved
 Ai 11-2504-14 14 cm/5 1/2" 1 x 2 curved

ATRAUMA



DEBAKEY-MOSQUITO

Ai 11-2505-15 15 cm/5 7/8"

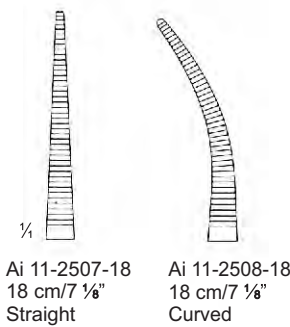
Ai 11-2506-15 15 cm/5 7/8"

Ai 11-2505-12 12.5 cm/4 7/8"

Ai 11-2506-12 12.5 cm/4 7/8"

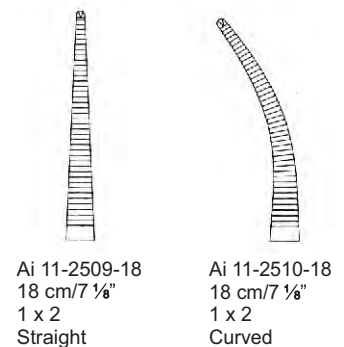


HALSTED-MOSQUITO



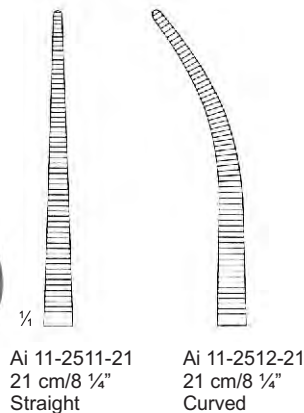
Ai 11-2507-18 18 cm/7 1/8" Straight

Ai 11-2508-18 18 cm/7 1/8" Curved



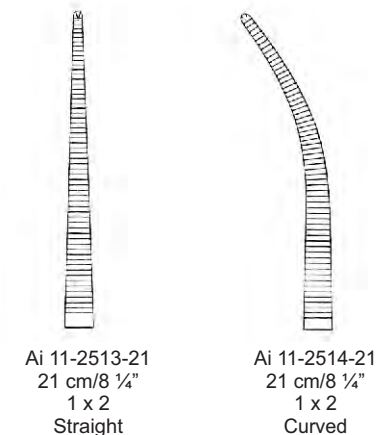
Ai 11-2509-18 18 cm/7 1/8" 1 x 2 Straight

Ai 11-2510-18 18 cm/7 1/8" 1 x 2 Curved



Ai 11-2511-21 21 cm/8 1/4" Straight

Ai 11-2512-21 21 cm/8 1/4" Curved

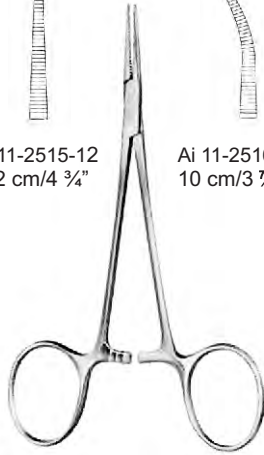


Ai 11-2513-21 21 cm/8 1/4" 1 x 2 Straight

Ai 11-2514-21 21 cm/8 1/4" 1 x 2 Curved



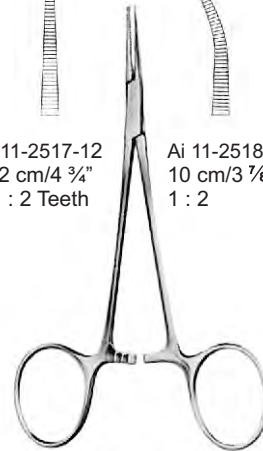
Ai 11-2515-10 10 cm/3 7/8" Ai 11-2515-12 12 cm/4 3/4"
 Ai 11-2516-10 10 cm/3 7/8" Ai 11-2516-12 12 cm/4 3/4"



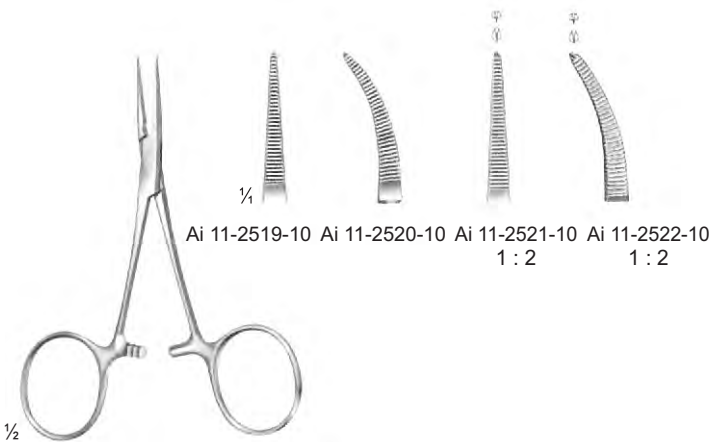
MICRO-MOSQUITO



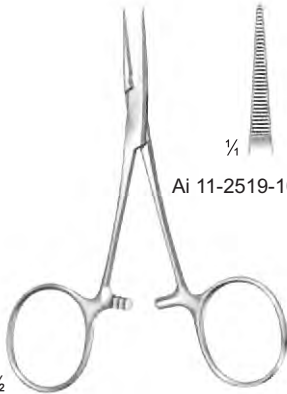
Ai 11-2517-10 10 cm/3 7/8" Ai 11-2517-12 12 cm/4 3/4" 1 : 2 Teeth
 Ai 11-2518-10 10 cm/3 7/8" Ai 11-2518-12 12 cm/4 3/4" 1 : 2 Teeth



MICRO-MOSQUITO



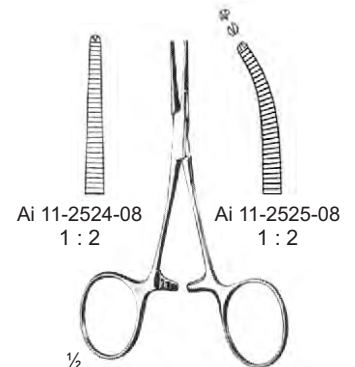
Ai 11-2519-10 Ai 11-2520-10 Ai 11-2521-10 Ai 11-2522-10
 1 : 2 1 : 2



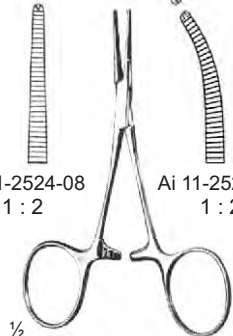
HARTMANN (BABY-MOSQUITO)
 10 cm/3 7/8"



CARREL
 Ai 11-2523-08
 8.5 cm/3 3/8"

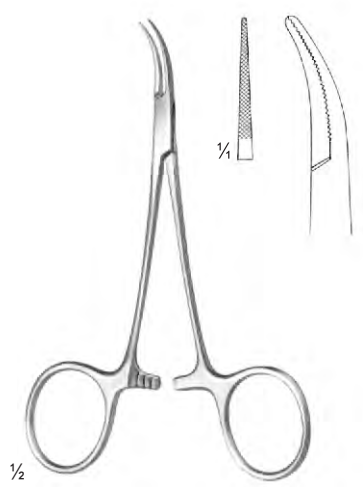


Ai 11-2524-08 1 : 2 Ai 11-2525-08 1 : 2

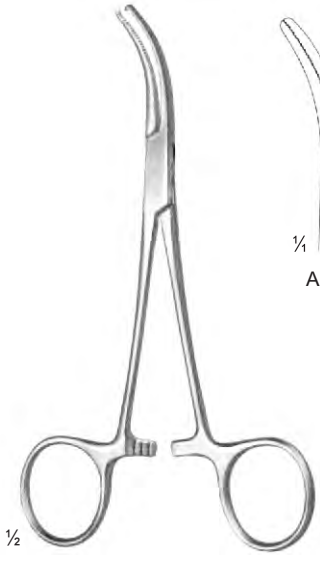


TERRIER
 8.5 cm/3 3/8"

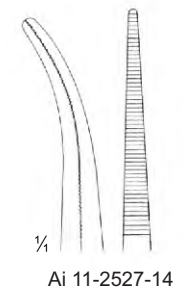




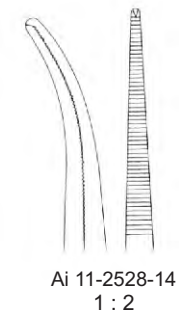
MOSQUITO-DANDY
 Ai 11-2526-12
 12 cm/4 3/4"



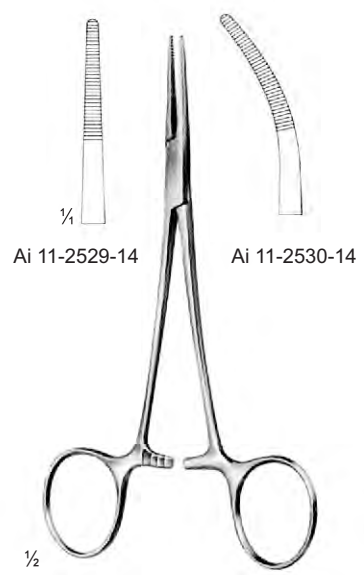
DANDY
 14 cm/5 1/2"



Ai 11-2527-14



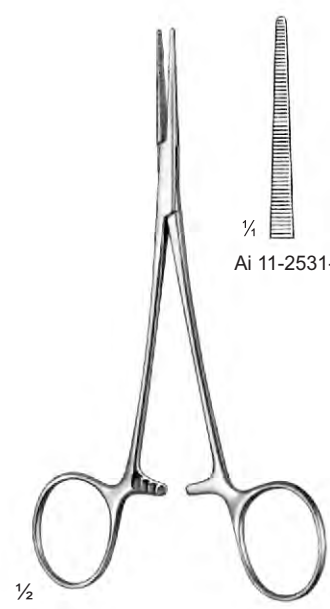
Ai 11-2528-14
 1 : 2



PROVIDENCE-HOSPITAL
 14 cm/5 1/2"

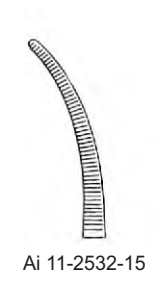
Ai 11-2529-14

Ai 11-2530-14

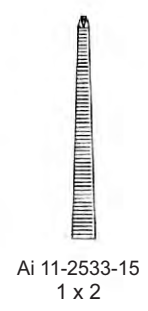


LERICHE
 15 cm/5 7/8"

Ai 11-2531-15



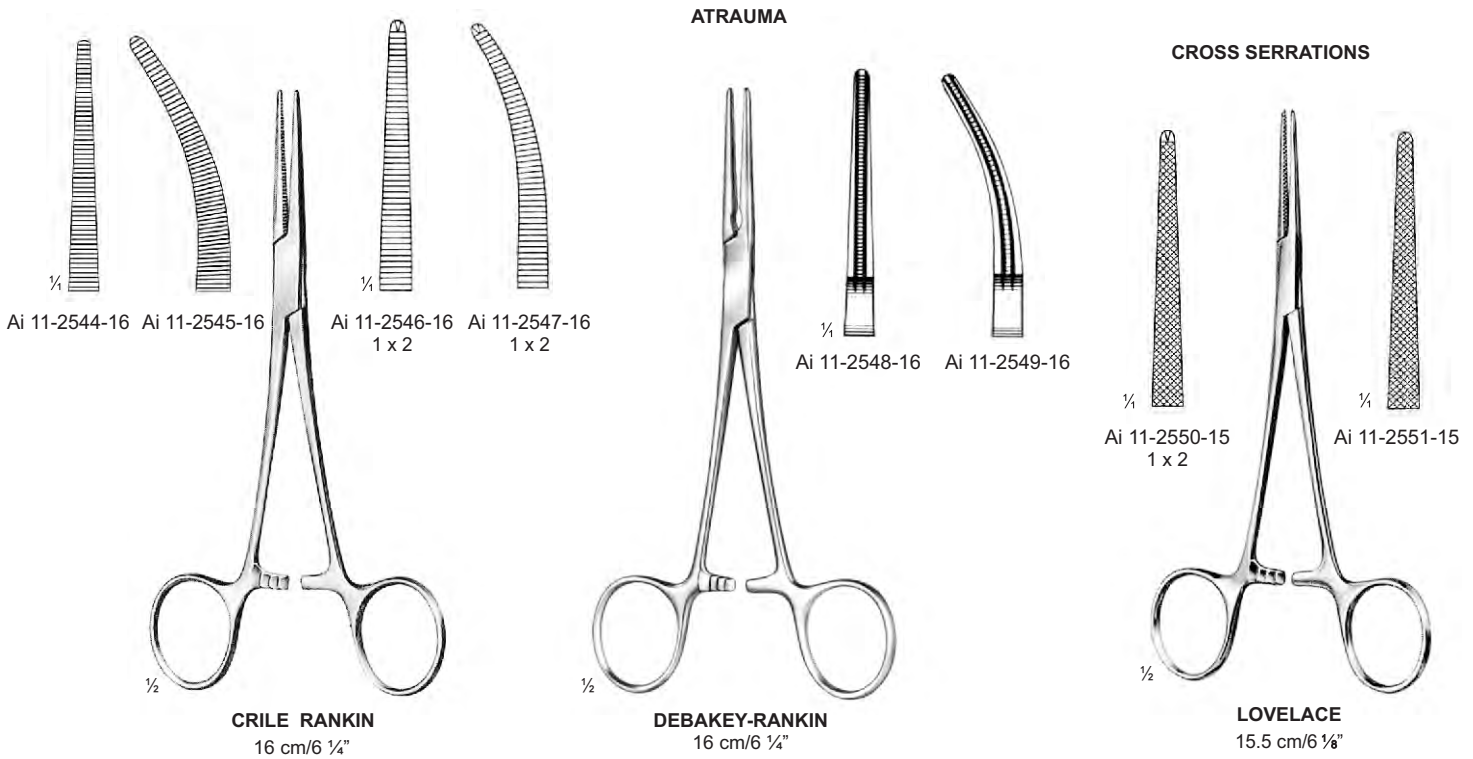
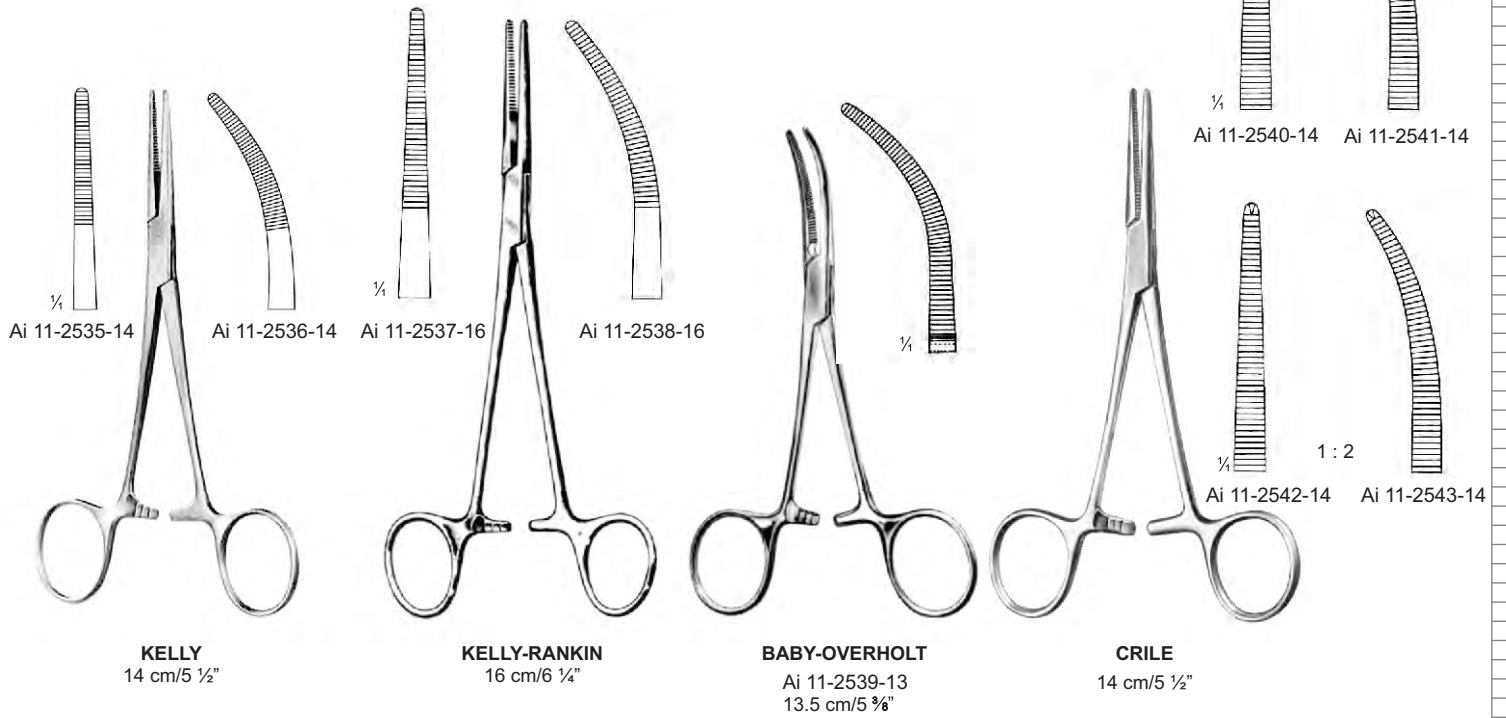
Ai 11-2532-15



Ai 11-2533-15
 1 x 2



Ai 11-2534-15
 1 x 2





SPENCER-WELLS/JONES



Ai 11-2552-13
13 cm/5 1/8"



Ai 11-2552-14
14.5 cm/5 3/4"



Ai 11-2552-15
15.5 cm/6 1/8"



Ai 11-2552-18
18.5 cm/7 1/4"



Ai 11-2552-20
20 cm/7 7/8"



Ai 11-2553-13
13 cm/5 1/8"



Ai 11-2553-14
14 cm/5 1/2"



Ai 11-2553-15
15 cm/5 7/8"



Ai 11-2553-18
18 cm/7 1/8"



Ai 11-2553-20
20 cm/7 7/8"



Ai 11-2554-13
13.5 cm/5 3/8"



Ai 11-2554-14
14.5 cm/5 3/4"



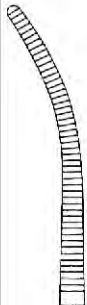
Ai 11-2554-17
17 cm/6 3/4"



Ai 11-2555-13
13 cm/5 1/8"



Ai 11-2555-14
14 cm/5 1/2"



Ai 11-2555-16
16.5 cm/6 1/2"



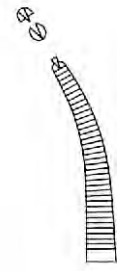
Cm	In	Straight
18	7 1/8"	Ai 11-2557-18
20	7 7/8"	Ai 11-2557-20
22	8 1/2"	Ai 11-2557-22
24	9 1/2"	Ai 11-2557-24
26	10 1/4"	Ai 11-2557-26
28	11"	Ai 11-2557-28



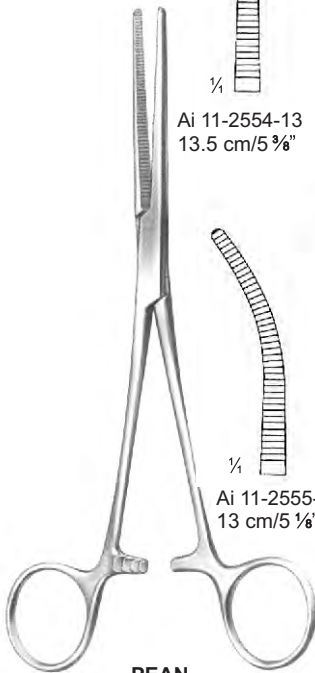
Cm	In	Curved
18	7 1/8"	Ai 11-2558-18
20	7 7/8"	Ai 11-2558-20
22	8 1/2"	Ai 11-2558-22
24	9 1/2"	Ai 11-2558-24
26	10 1/4"	Ai 11-2558-26
28	11"	Ai 11-2558-28



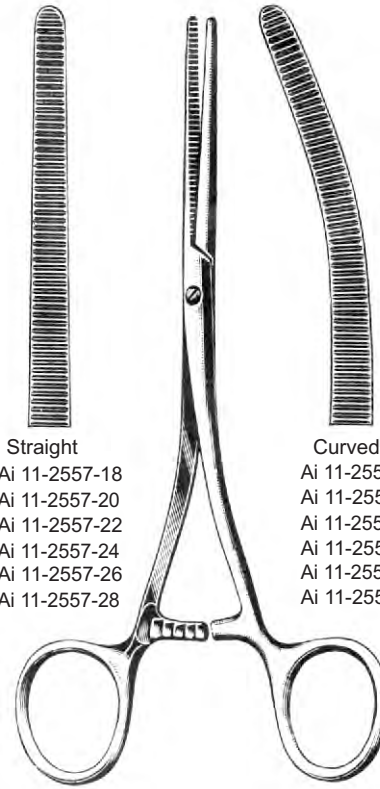
Ai 11-2559-18
1 x 2



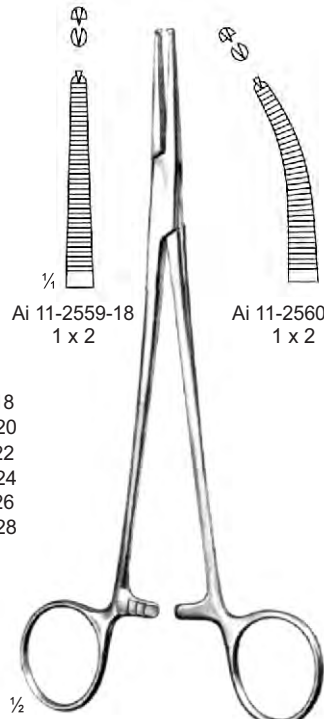
Ai 11-2560-18
1 x 2



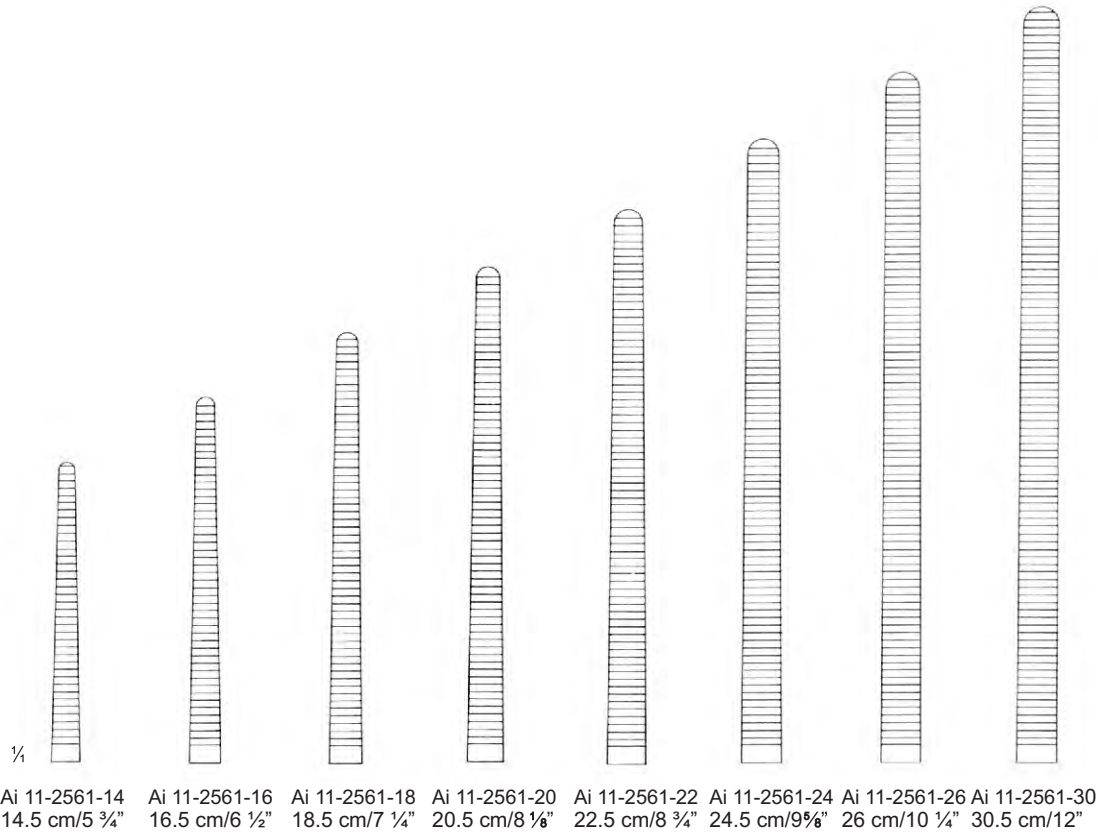
PEAN
DELICATE PATTERN



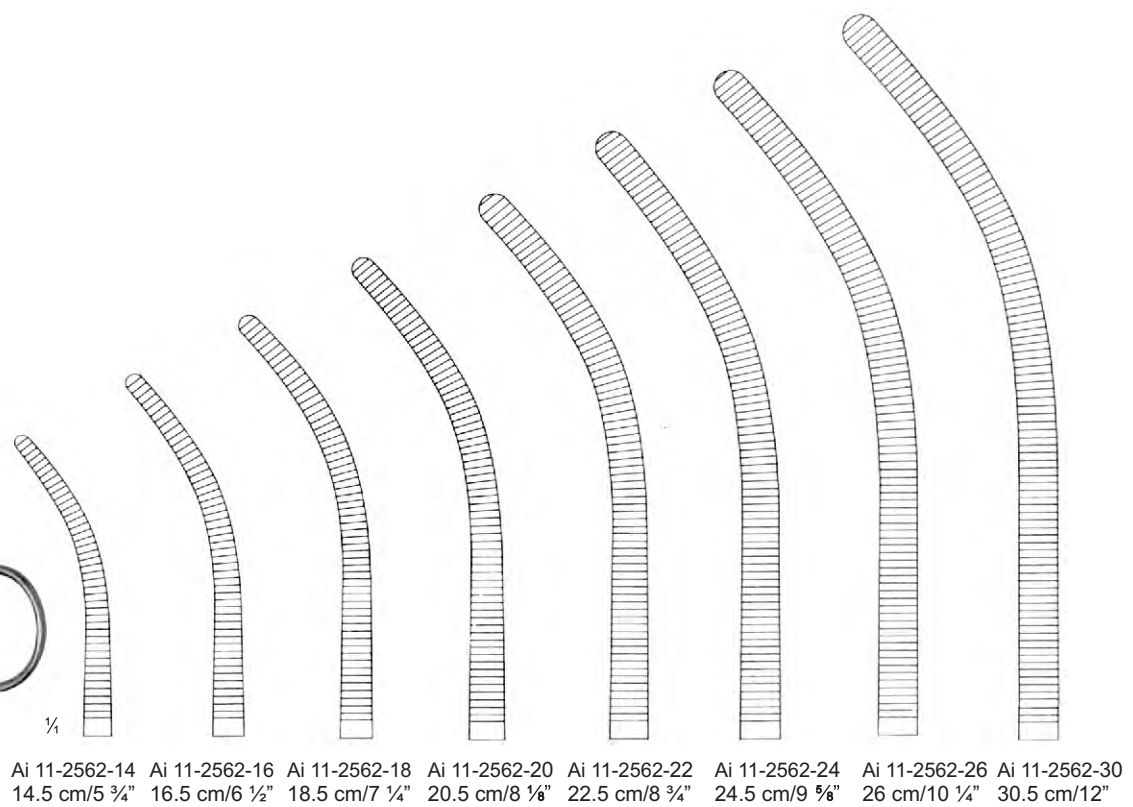
PEAN



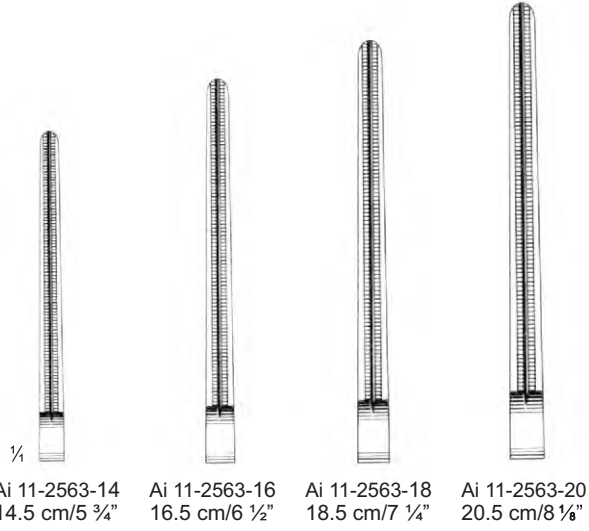
ADSON
18.5 cm/7 1/4"



ROCHESTER-PEAN



ATRAUMA



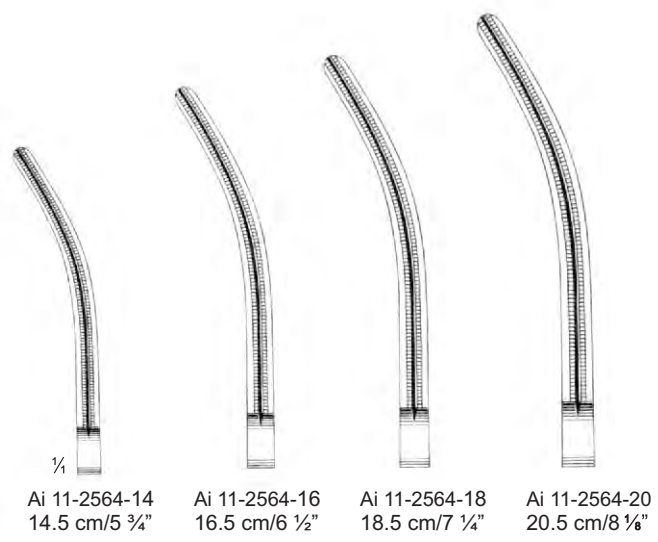
Ai 11-2563-14
14.5 cm/5 3/4"

Ai 11-2563-16
16.5 cm/6 1/2"

Ai 11-2563-18
18.5 cm/7 1/4"

Ai 11-2563-20
20.5 cm/8 1/8"

DEBAKEY-PEAN



Ai 11-2564-14
14.5 cm/5 3/4"

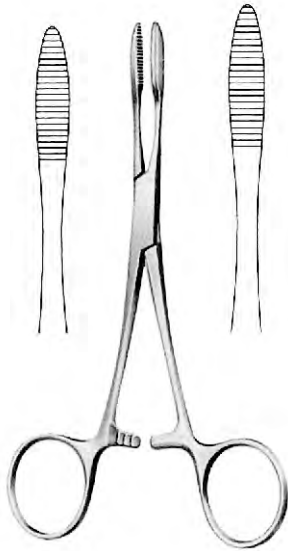
Ai 11-2564-16
16.5 cm/6 1/2"

Ai 11-2564-18
18.5 cm/7 1/4"

Ai 11-2564-20
20.5 cm/8 1/8"

DEBAKEY-PEAN

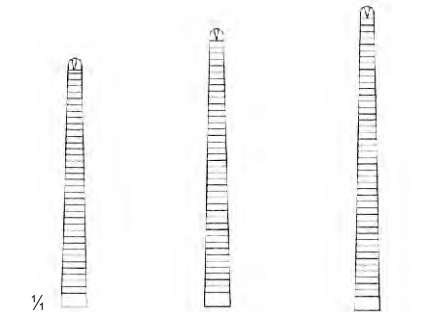




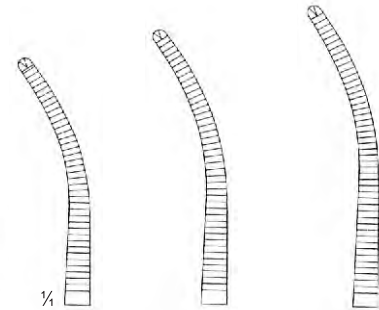
PEAN
Ai 11-2565-14 14 cm/5 1/2"
Ai 11-2565-16 16 cm/6 1/4"



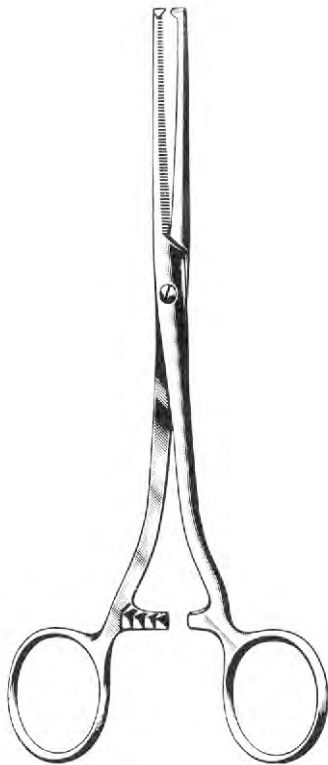
KOCHER
Delicate Pattern
1 : 2



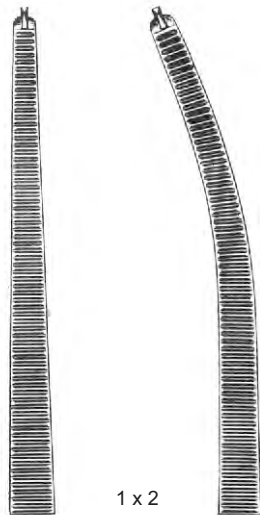
1/4
Ai 11-2566-13 13 cm/5 1/8"
Ai 11-2566-14 14 cm/5 1/2"
Ai 11-2566-16 16 cm/6 1/4"



1/4
Ai 11-2567-13 13 cm/5 1/8"
Ai 11-2567-14 14 cm/5 1/2"
Ai 11-2567-16 16 cm/6 1/4"

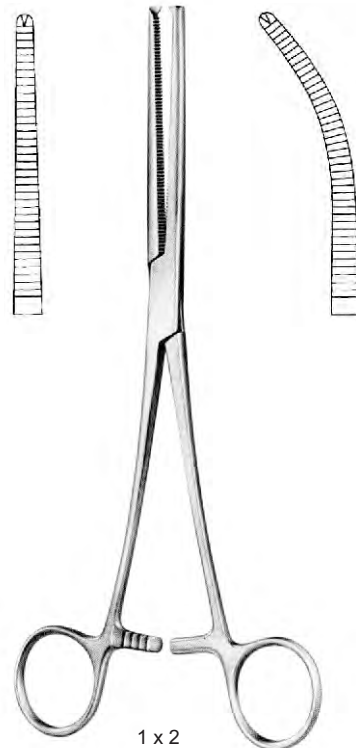


KOCHER



1 x 2

Ai 11-2568-18 18 cm/7 1/8"
Ai 11-2568-20 20 cm/7 7/8"
Ai 11-2568-22 22 cm/8 1/2"
Ai 11-2568-24 24 cm/9 1/2"
Ai 11-2568-26 26 cm/10 1/4"
Ai 11-2569-18
Ai 11-2569-20
Ai 11-2569-22
Ai 11-2569-24
Ai 11-2569-26

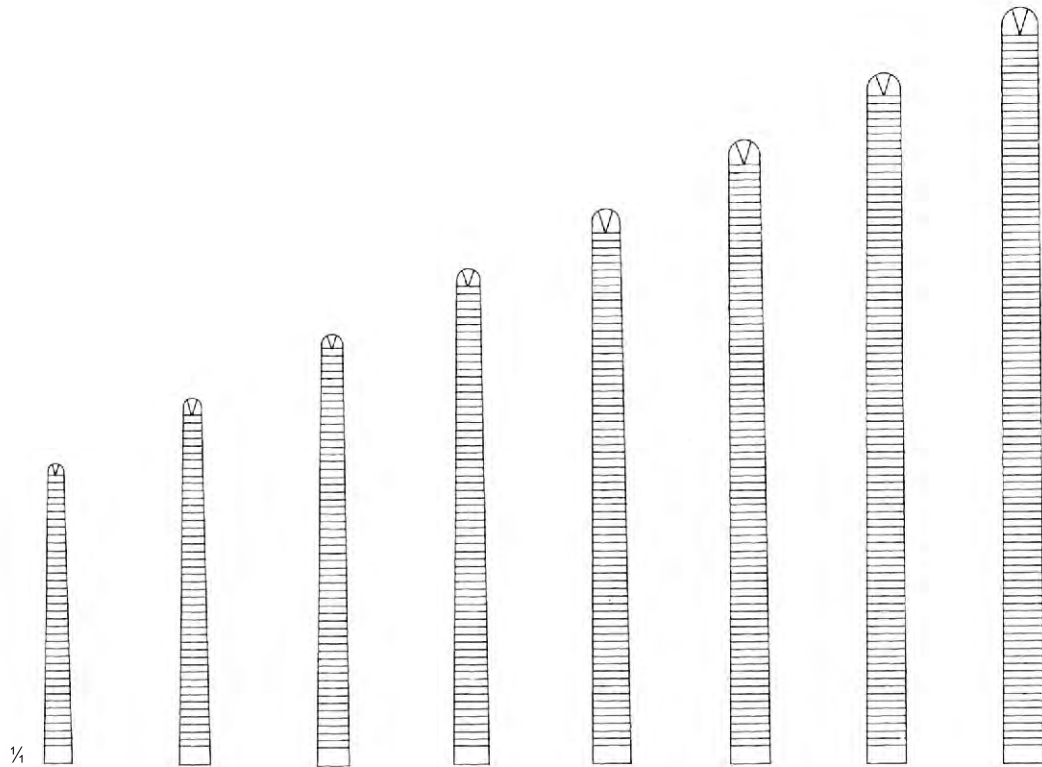


1 x 2

KOCHER (STANDARD)

Ai 11-2570-13 13 cm/5 1/8"
Ai 11-2570-14 14 cm/5 1/2"
Ai 11-2571-14 14.5cm/5 3/4"
Ai 11-2572-13
Ai 11-2572-14
Ai 11-2573-14

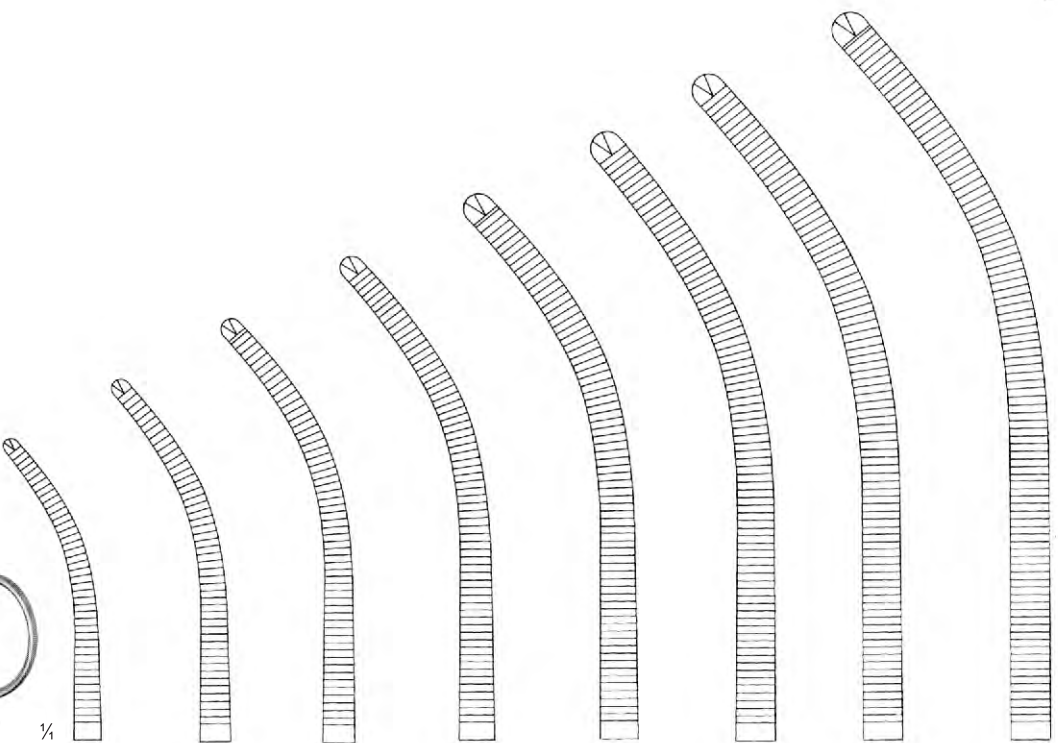




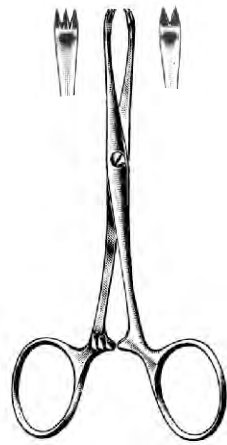
Ai 11-2574-16 16 cm/6 1/4" Ai 11-2574-18 18 cm/7 1/8" Ai 11-2574-20 20 cm/7 7/8" Ai 11-2574-22 22 cm/8 1/2" Ai 11-2574-24 24 cm/9 1/2" Ai 11-2574-26 26 cm/10 1/4" Ai 11-2574-28 28 cm/11" Ai 11-2574-30 30 cm/11 3/4"



KOCHER OCHSNER
1 : 2

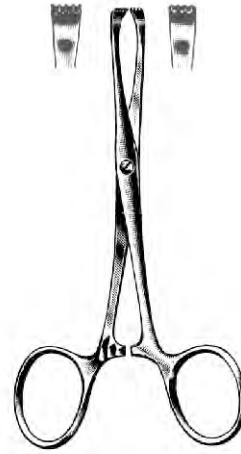


Ai 11-2575-16 16 cm/6 1/4" Ai 11-2575-18 18 cm/7 1/8" Ai 11-2575-20 20 cm/7 7/8" Ai 11-2575-22 22 cm/8 1/2" Ai 11-2575-24 24 cm/9 1/2" Ai 11-2575-26 26 cm/10 1/4" Ai 11-2575-28 28 cm/11" Ai 11-2575-30 30 cm/11 3/4"



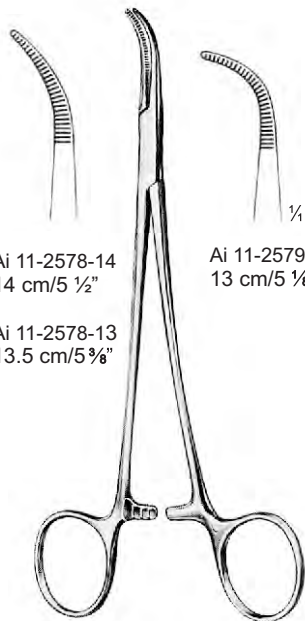
CHAPUT

Ai 11-2576-13
 13 cm/5 1/8"



TUFFIER

Ai 11-2577-13
 13 cm/5 1/8"



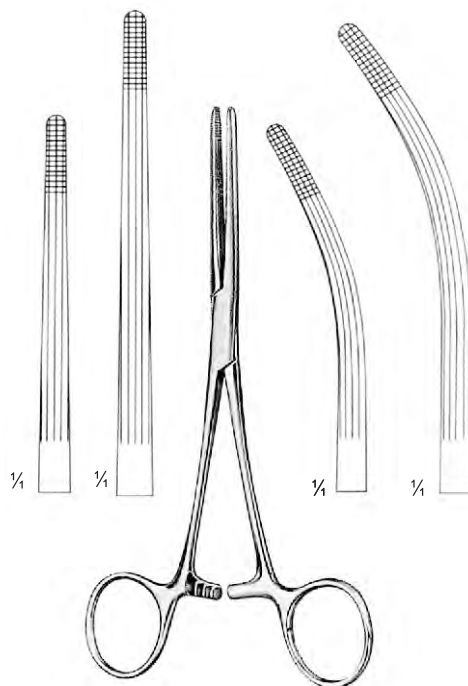
Ai 11-2578-14
 14 cm/5 1/2"

Ai 11-2578-13
 13.5 cm/5 3/8"

BABY-MIXTER

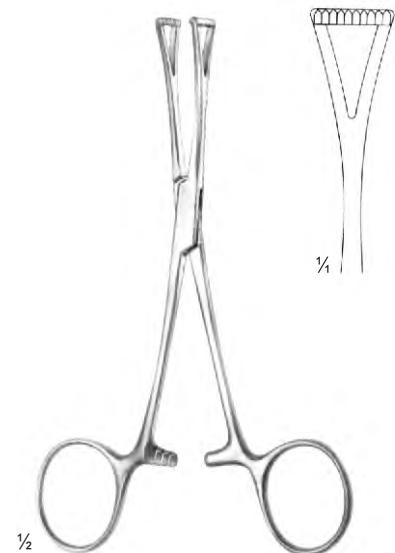


Ai 11-2579-13
 13 cm/5 1/8"



ROCHESTER-CARMALT

Ai 11-2580-16 16 cm/6 1/4" Ai 11-2581-16
 Ai 11-2580-20 20 cm/7 7/8" Ai 11-2581-20



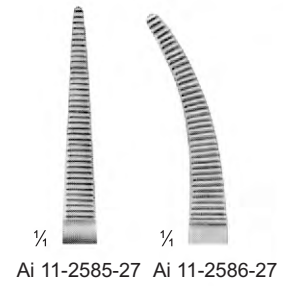
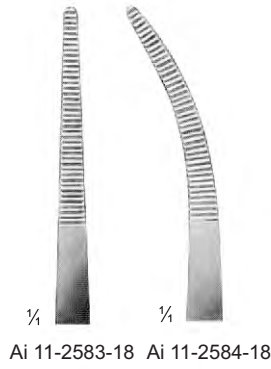
COLLIN

Ai 11-2582-14
 14 cm/5 1/2"

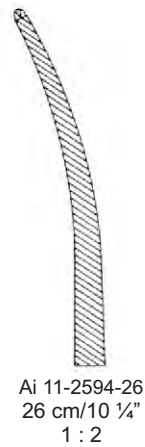
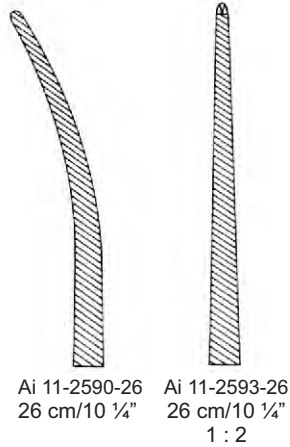
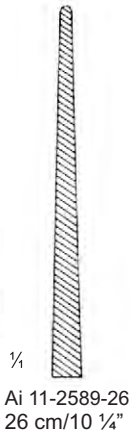
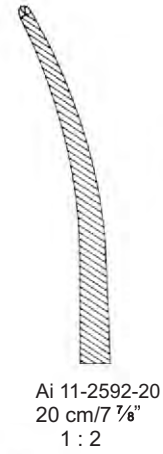
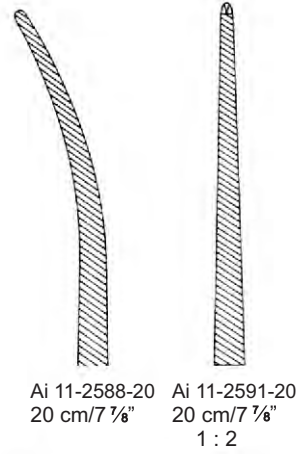
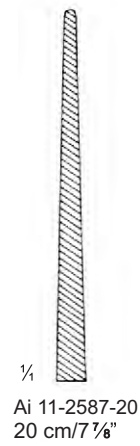




BIRKET
18.5 cm/7 ¼"



BENGOLEA



BRIDGE
27.5 cm/10 ¾"



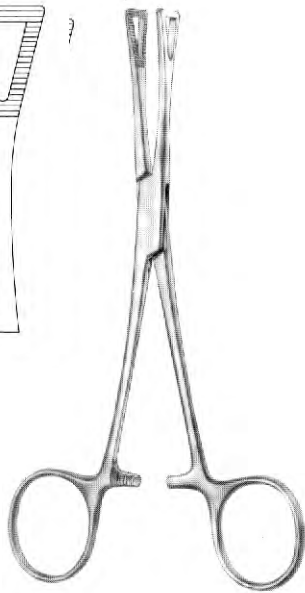
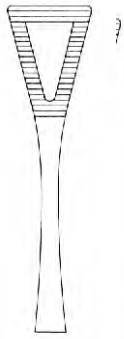
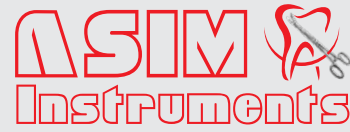
ARTERY FORCEPS

Pressure Clamps, Haemorrhoidal Clamps

Druckklemmen, Hämorrhoidenklemmen

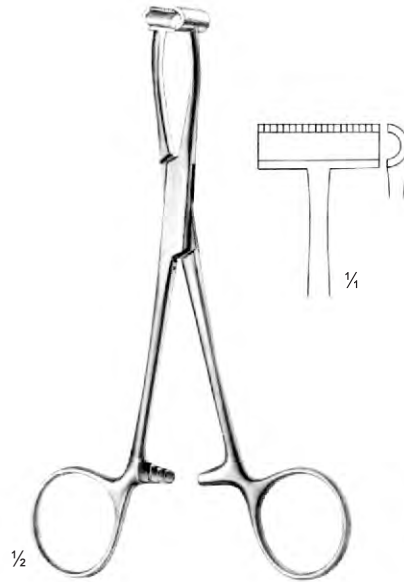
Pinza-Clamp de presión progresiva, Pinza-Clamps para hemorroides

- EN
- DE
- ES



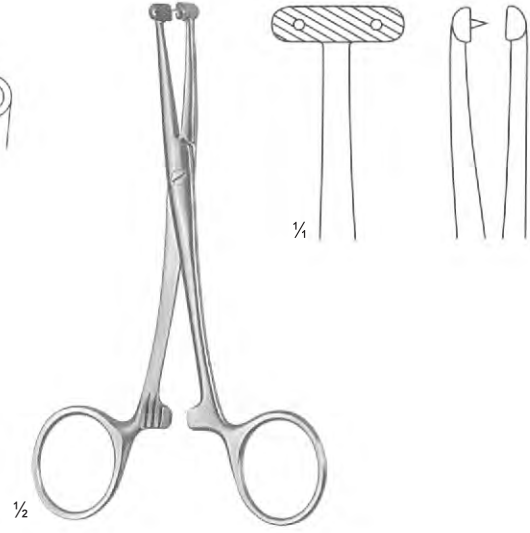
PENNINGTON

Ai 11-2595-15 15.5 cm/6 1/8"
Ai 11-2595-20 20 cm/7 7/8"



PRATT

Ai 11-2596-15
15 cm/5 7/8"



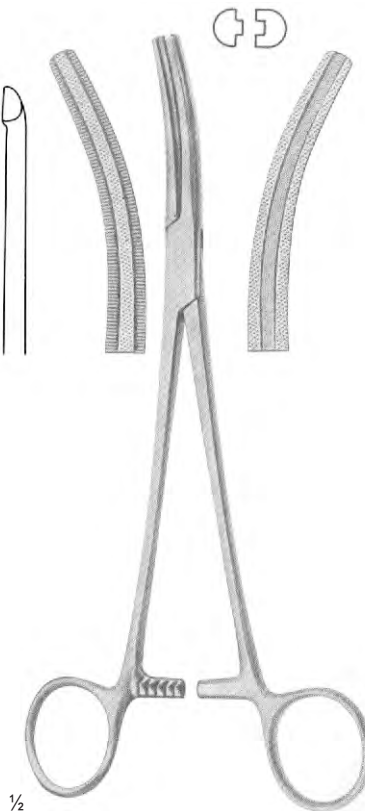
MARTEL

Ai 11-2597-14
14 cm/5 1/2"



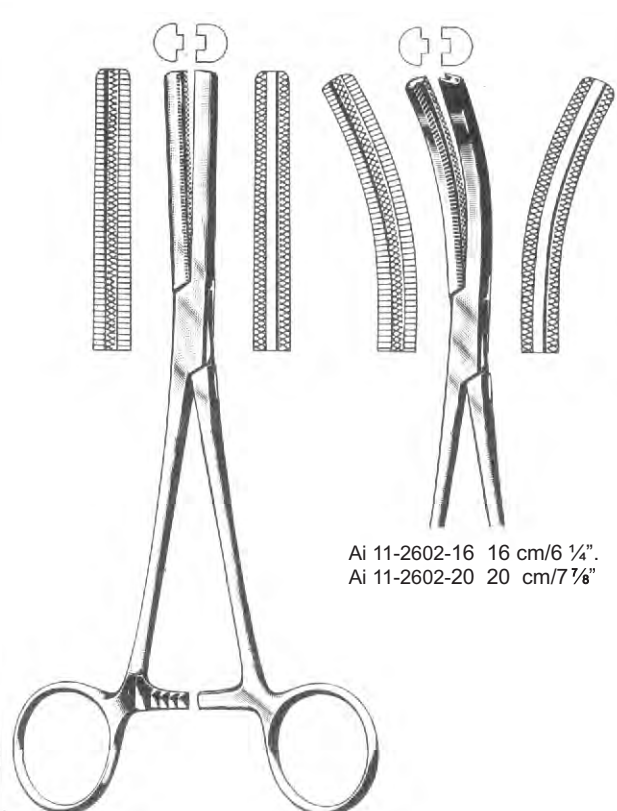
WILLET-MARTEL

Ai 11-2598-19
19 cm/7 1/2"



BUIE

Ai 11-2599-21
21 cm/8 1/4"

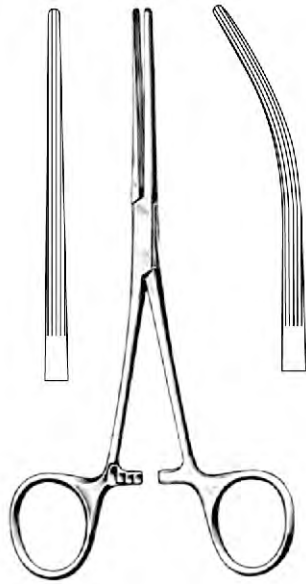


FERGUSSON

Ai 11-2600-16 16 cm/6 1/4"
Ai 11-2600-20 20 cm/7 7/8"

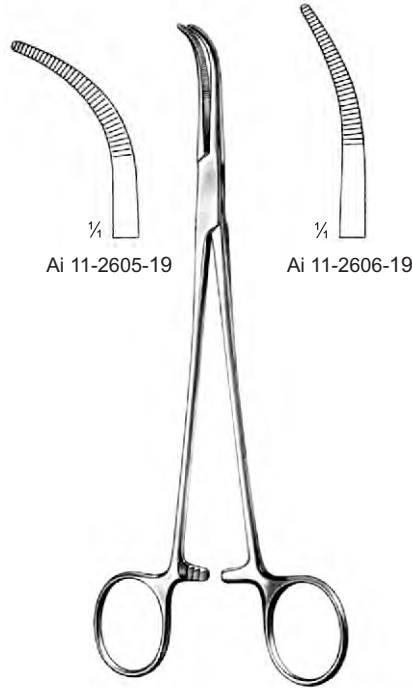
Ai 11-2602-16 16 cm/6 1/4"
Ai 11-2602-20 20 cm/7 7/8"





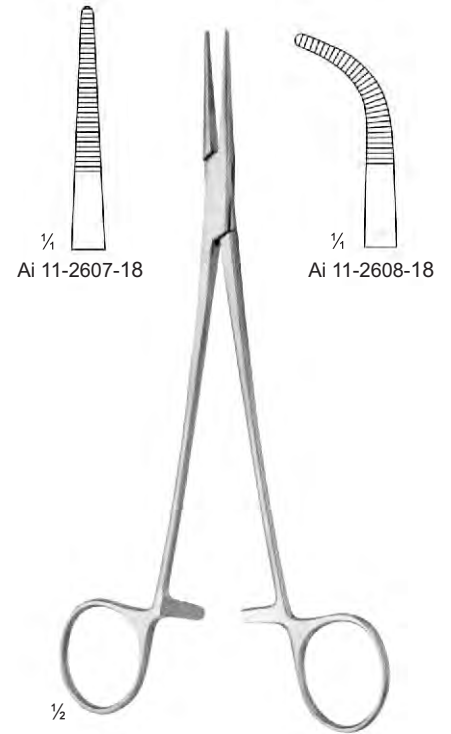
BAINBRIDGE

Ai 11-2603-15 15 cm/5 7/8" Ai 11-2604-15
 Ai 11-2603-18 18.5 cm/7 1/4" Ai 11-2604-18



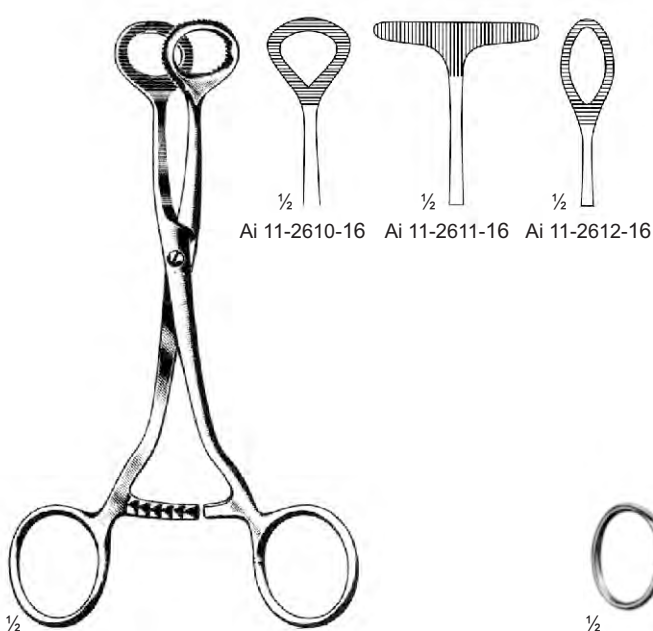
SCHNIDT

19 cm/7 1/2"



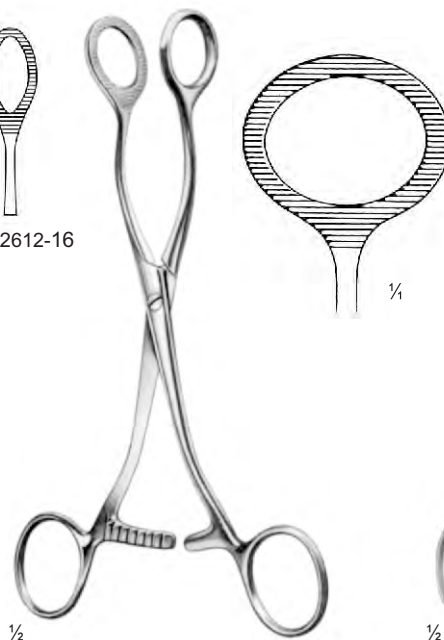
ADSON

18.5 cm/7 1/4"



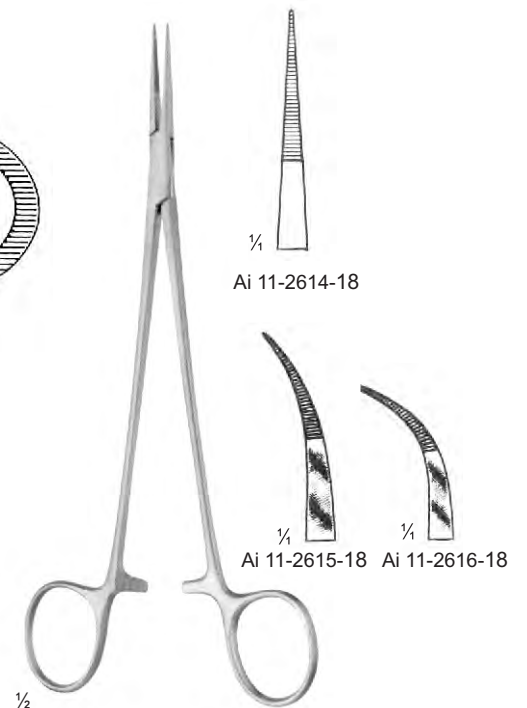
COLLIN

Ai 11-2609-16
 16 cm/6 1/4"



COLLIN

Ai 11-2613-16
 16.5 cm/6 1/2"



JACOBSON-MICRO

18 cm/7 1/8"

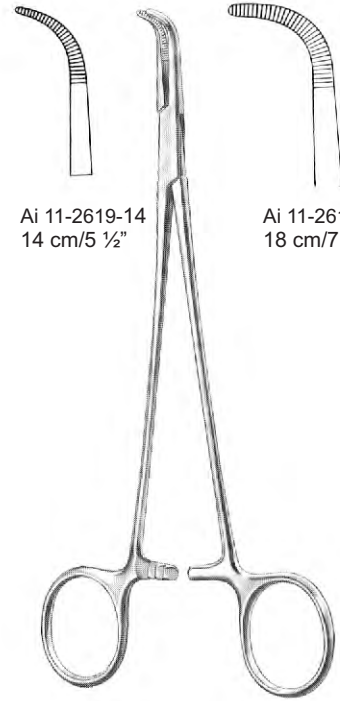




BABY-MIXTER
 Ai 11-2617-18
 18 cm/7 1/8"



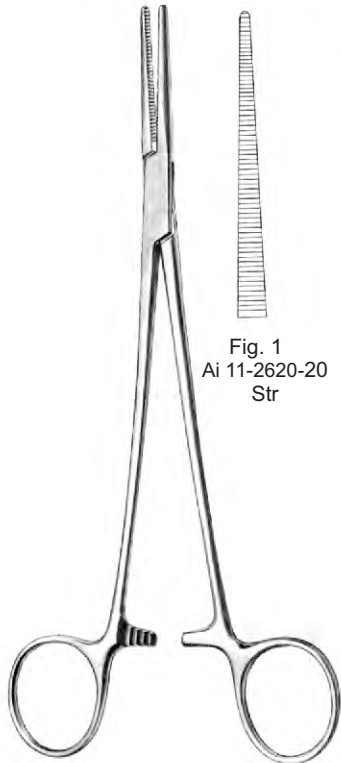
MICRO-ADSON
 Ai 11-2618-14
 14 cm/5 1/2"



Ai 11-2619-14
 14 cm/5 1/2"

Ai 11-2619-18
 18 cm/7 1/8"

ADSON-BABY



HEISS
 20 cm/7 7/8"

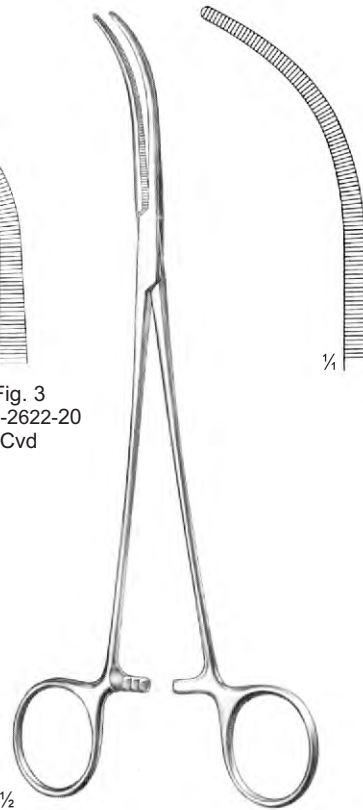
Fig. 1
 Ai 11-2620-20
 Str



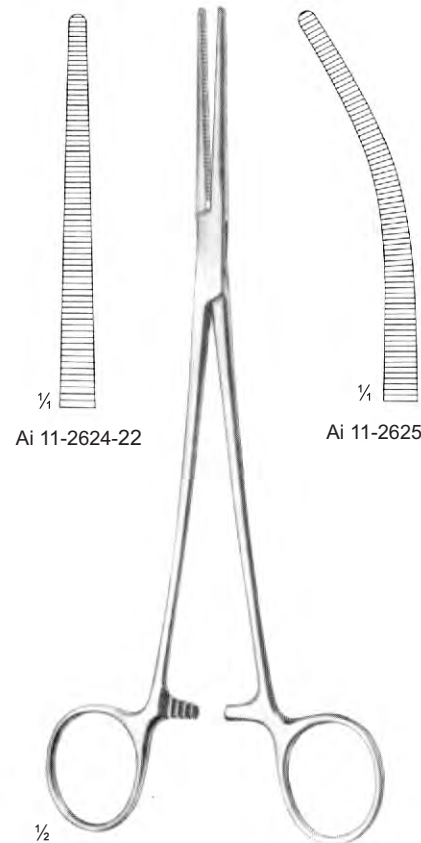
Fig. 2
 Ai 11-2621-20
 Slightly Cvd



Fig. 3
 Ai 11-2622-20
 Cvd



OVERHOLT-MIXTER
 Ai 11-2623-21
 21 cm/8 1/4"

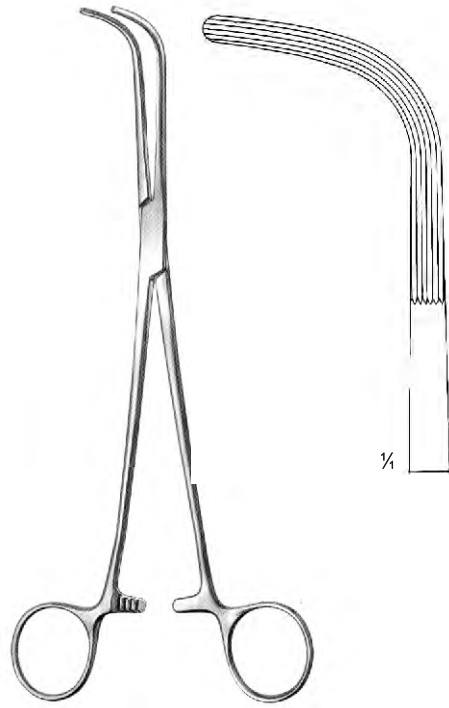


ROBERTS
 22 cm/8 1/2"

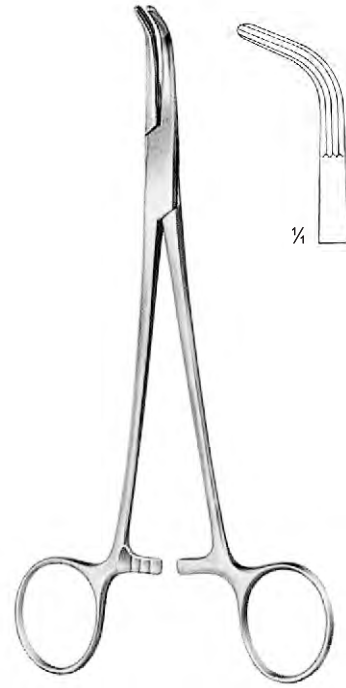
Ai 11-2624-22

Ai 11-2625-22





MCQUIGG-MIXTER
 Ai 11-2626-23
 23.5 cm/9 1/4"



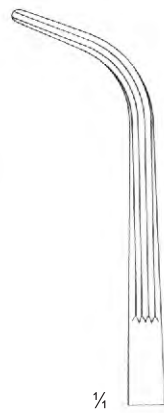
LAHEY
 Ai 11-2627-18
 18.5 cm/7 1/4"



LAHEY



Ai 11-2628-19
 19.5 cm/7 1/2"



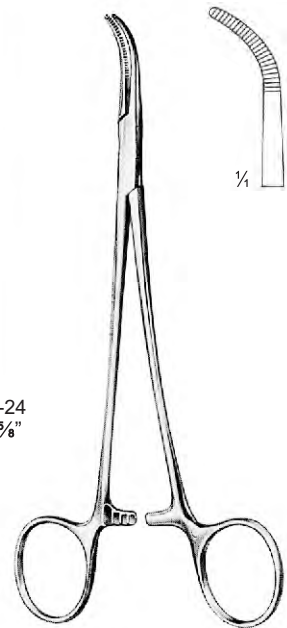
Ai 11-2629-22
 22.5 cm/8 3/4"



FINOCHIETTO



Ai 11-2630-24
 24.5 cm/9 5/8"



MIXTER-BABY
 Ai 11-2631-14
 14 cm/5 1/2"



KELLY



Fig. 1
 Ai 11-2632-19
 19 cm/7 1/2"



Fig. 1
 Ai 11-2632-22
 22.5 cm/8 3/4"



Fig. 1
 Ai 11-2632-24
 24.5 cm/9 3/4"



Fig. 2
 Ai 11-2633-19
 19 cm/7 1/2"



Fig. 2
 Ai 11-2633-22
 22 cm/8 1/2"



Fig. 2
 Ai 11-2633-23
 23.5 cm/9 1/4"



Fig. 3
 Ai 11-2634-18
 18.5 cm/7 1/4"



Fig. 3
 Ai 11-2634-21
 21.5 cm/8 1/2"



Fig. 3
 Ai 11-2634-23
 23.5 cm/9 1/4"





LAWRENCE
Ai 11-2635-28
28 cm/11"



WIKSTROEM

Ai 11-2636-21
21 cm/8 1/4"

Ai 11-2636-24
24.5 cm/9 5/8"



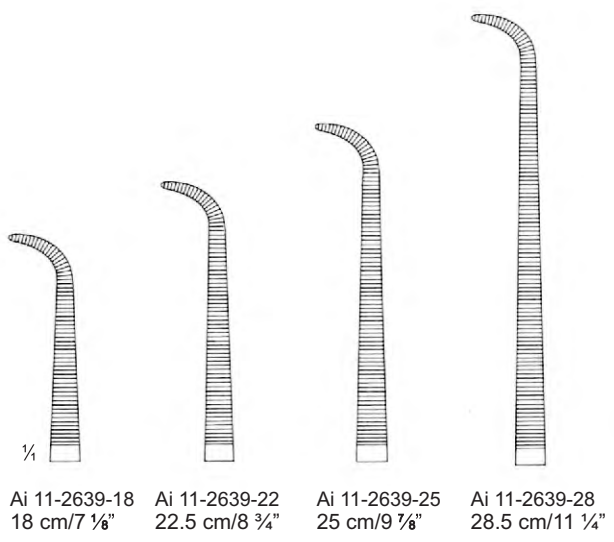
MEEKER
Ai 11-2637-28
28 cm/11"



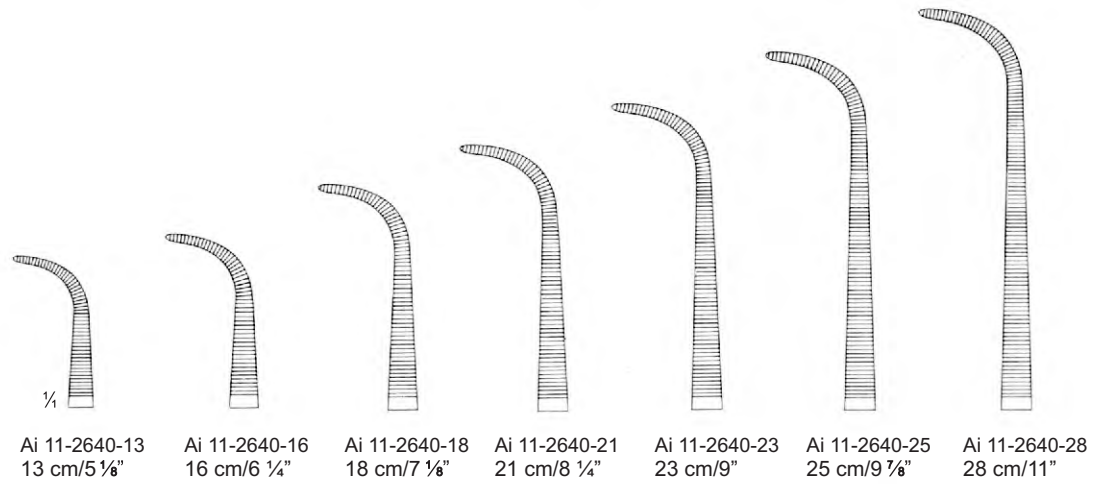
MIXTER-CRAFOORD
Ai 11-2638-25 25 cm/9 1/8"
Ai 11-2638-27 27 cm/10 1/2"

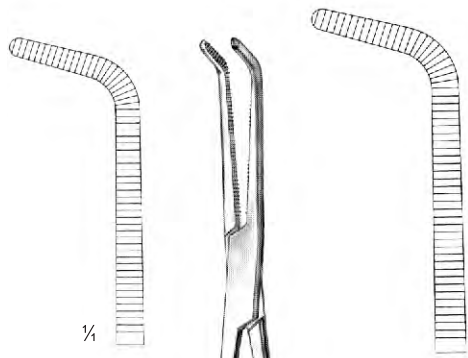


MINI-GEMINI



GEMINI





1/4



MIXTER

Ai 11-2641-14 14.5 cm/5 3/4"
 Ai 11-2641-15 15.5 cm/6 1/8"
 Ai 11-2641-19 19 cm/7 1/2"



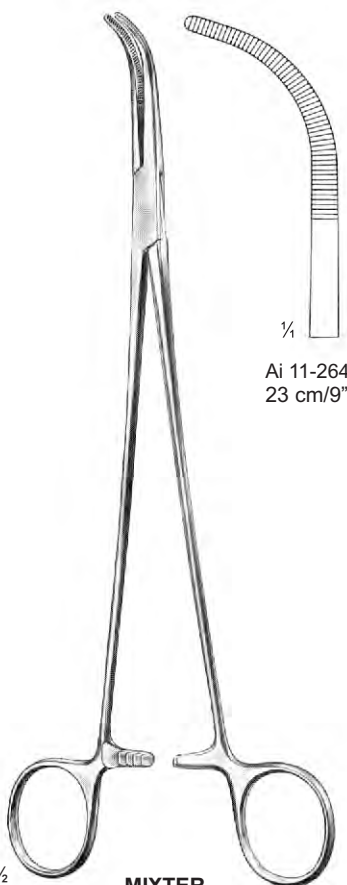
1/4



1/2

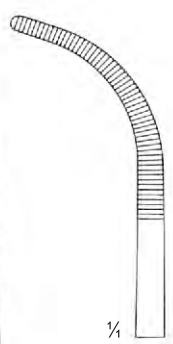
MIXTER

Ai 11-2642-22
 22 cm/8 1/2"



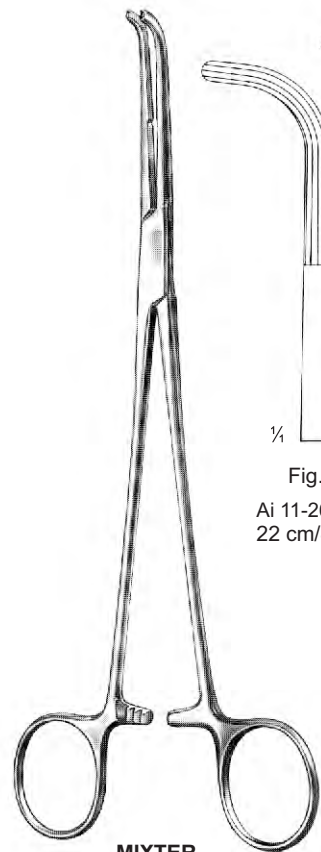
1/2

MIXTER



1/4

Ai 11-2643-23
 23 cm/9"



MIXTER

1/4

Fig. 1

Ai 11-2644-22
 22 cm/8 1/2"

2

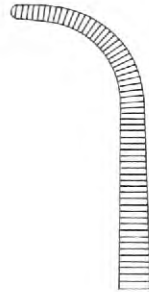
Ai 11-2644-25
 25 cm/9 7/8"

3

Ai 11-2644-28
 28 cm/11"



O'SHAUGNESSY



Ai 11-2645-15
15 cm/5 7/8"



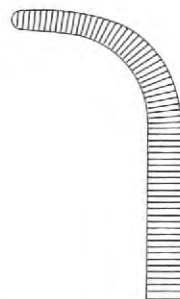
Ai 11-2645-18
18 cm/7 1/8"



Ai 11-2645-19
18.5 cm/7 1/4"



Ai 11-2645-20
20 cm/7 7/8"

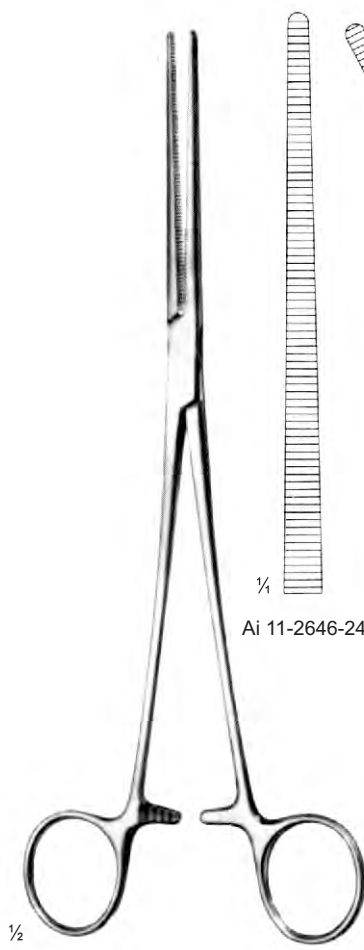


Ai 11-2645-23
23 cm/9"

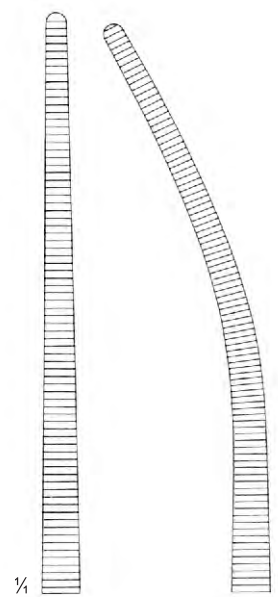


Ai 11-2645-26
26 cm/10 1/4"

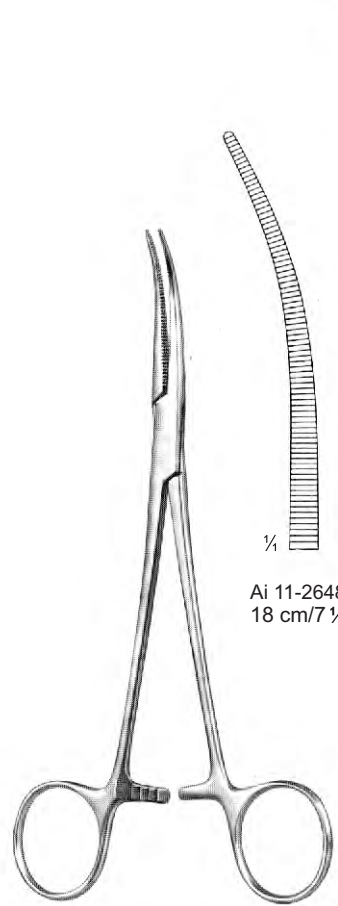




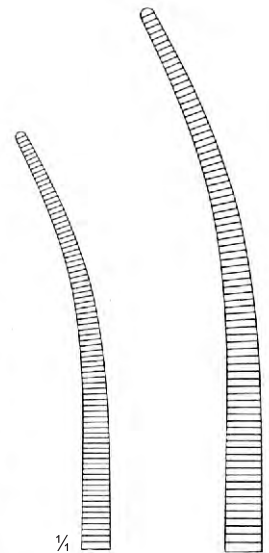
SAROT
24 cm/9 1/2"



Ai 11-2646-24 Ai 11-2647-24



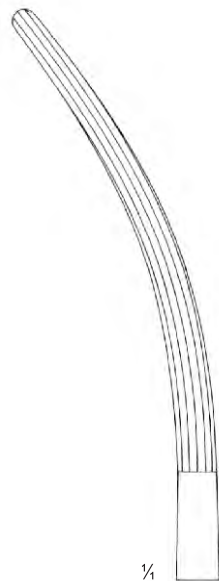
CRAFOORD



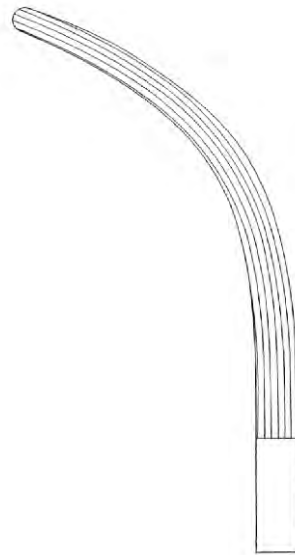
Ai 11-2648-18 Ai 11-2648-24
18 cm/7 1/8" 24 cm/9 1/2"



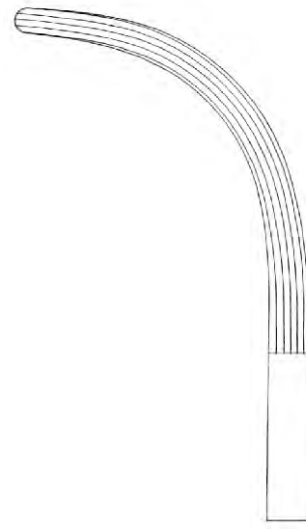
CRAFOORD-SELLORS
 24 cm/9 1/2"
 Vascular Clamp



Ai 11-2649-24



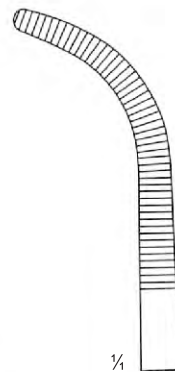
Ai 11-2650-24



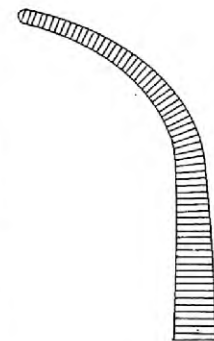
Ai 11-2651-24



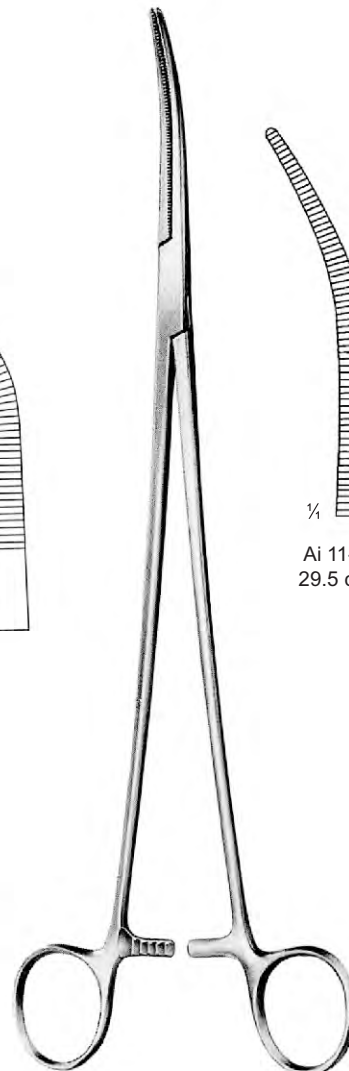
JOHNS HOPKINS
 Ai 11-2652-20
 20 cm/7 7/8"



Ai 11-2653-29
 29.5 cm/11 5/8"



Ai 11-2653-28
 28.5 cm/11 1/4"



ZENKER



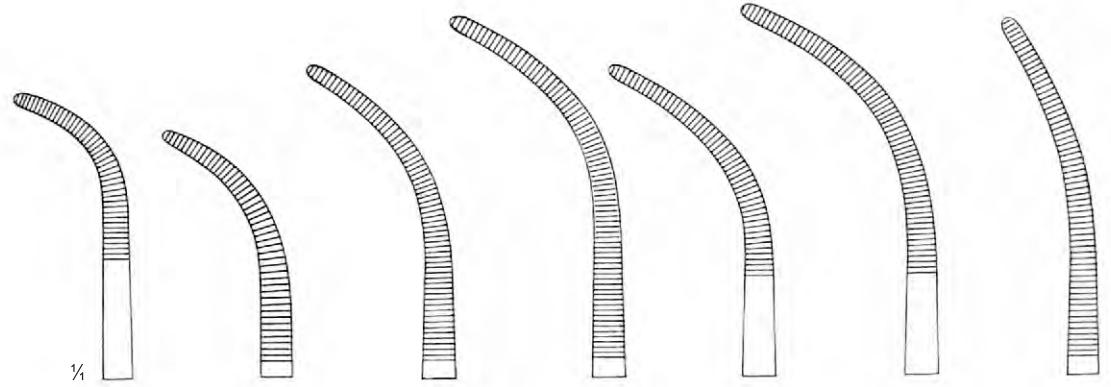


Fig. 1 Ai 11-2654-20 20.5 cm/8 1/8"	Fig. 2 Ai 11-2655-20 20 cm/7 7/8"	Fig. 3 Ai 11-2655-21 21.5 cm/8 1/2"	Fig. 4 Ai 11-2655-22 22 cm/8 1/2"	Fig. 5 Ai 11-2656-21 21.5 cm/8 1/2"	Fig. 6 Ai 11-2656-22 22 cm/8 1/2"	Fig. 7 Ai 11-2657-22 22 cm/8 1/2"
---	---	---	---	---	---	---



OVERHOLT-GEISSENDORFER

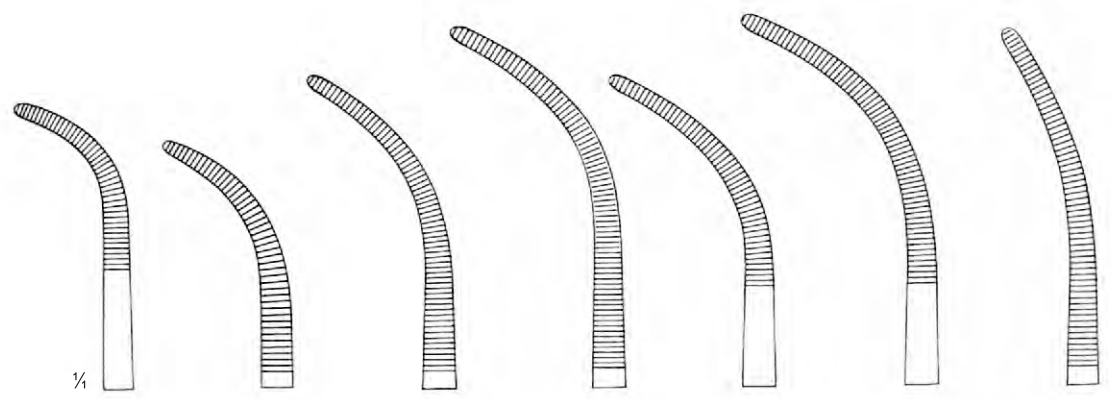
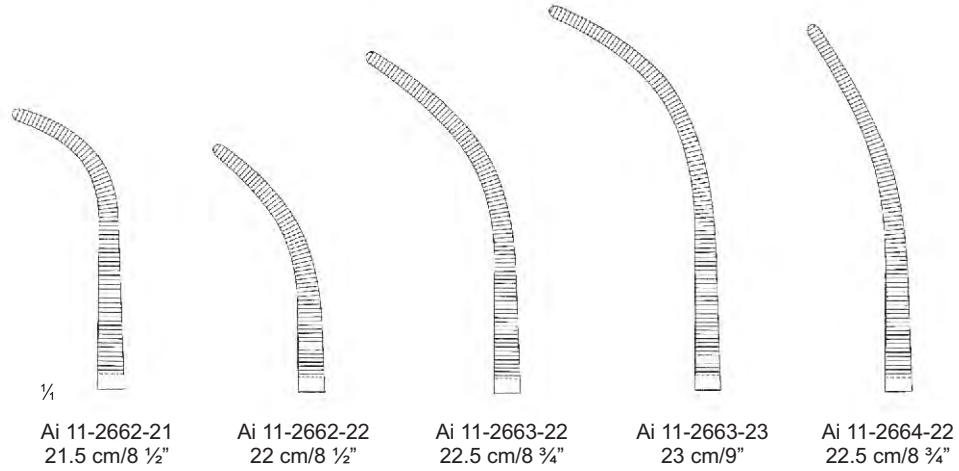


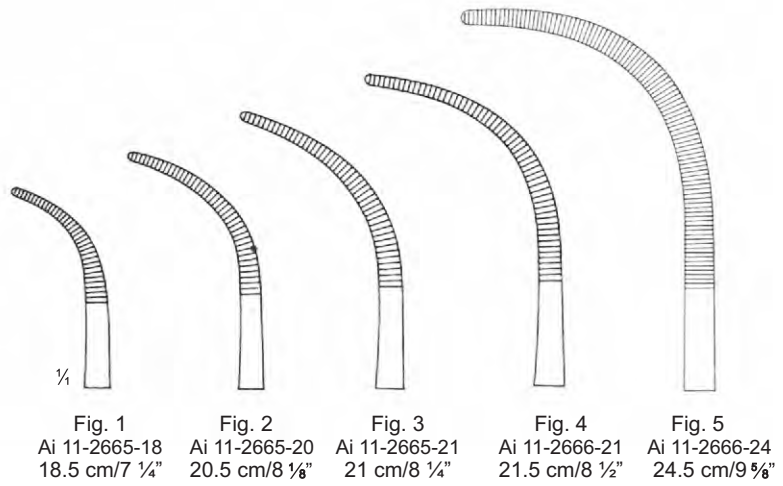
Fig. 1 Ai 11-2658-27 27 cm/10 1/2"	Fig. 2 Ai 11-2658-26 26.5 cm/10 3/8"	Fig. 3 Ai 11-2659-27 27.5 cm/10 3/4"	Fig. 4 Ai 11-2659-28 28 cm/11"	Fig. 5 Ai 11-2660-27 27.5 cm/10 3/4"	Fig. 6 Ai 11-2660-28 28 cm/11"	Fig. 7 Ai 11-2661-28 27.5 cm/10 3/4"
--	--	--	--------------------------------------	--	--------------------------------------	--



OVERHOLT-FINO

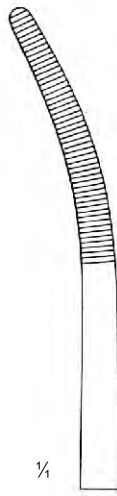


OVERHOLT-SLIM





$\frac{1}{2}$
RUMEL
 23 cm/9"

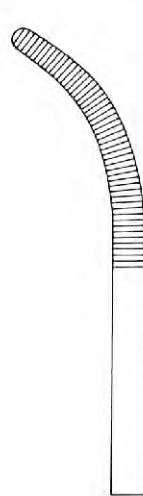


$\frac{1}{4}$

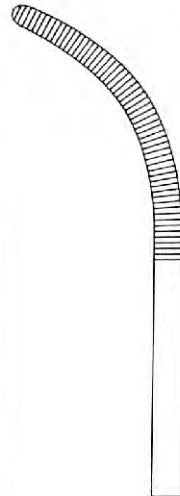
Ai 11-2667-23



Ai 11-2668-23



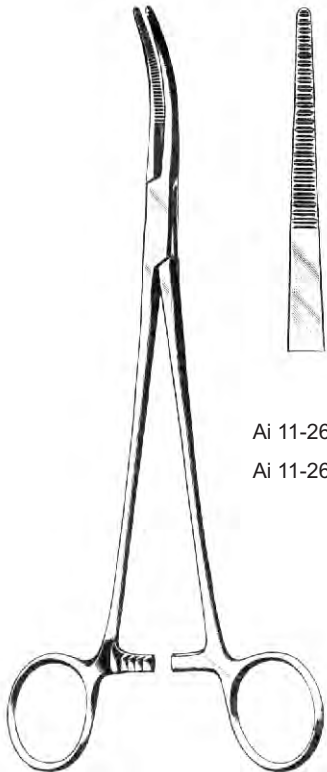
Ai 11-2669-23



Ai 11-2670-23



Ai 11-2671-23



Ai 11-2672-21
 Ai 11-2672-26



TOENNIS



Ai 11-2673-21 21.0 cm 8 $\frac{1}{4}$ "
 Ai 11-2673-26 26.0 cm 10 $\frac{1}{4}$ "



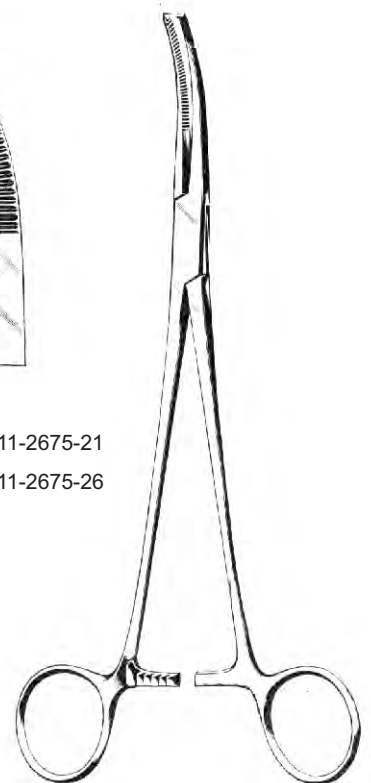
Ai 11-2674-21
 Ai 11-2674-26

TOENNIS



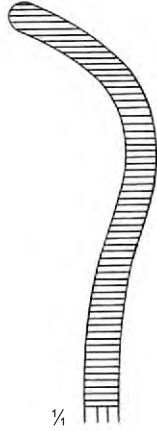
1 : 2

Ai 11-2675-21
 Ai 11-2675-26

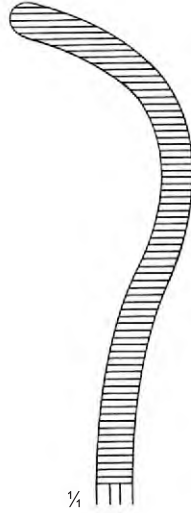




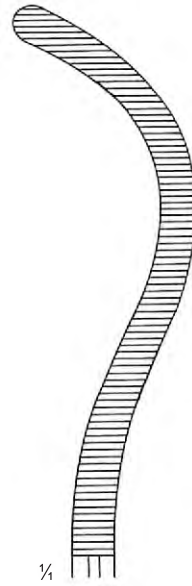
GUYON



Ai 11-2676-20
 20 cm/7 7/8"



Ai 11-2676-22
 22 cm/8 1/2"



Ai 11-2676-24
 24 cm/9 1/2"

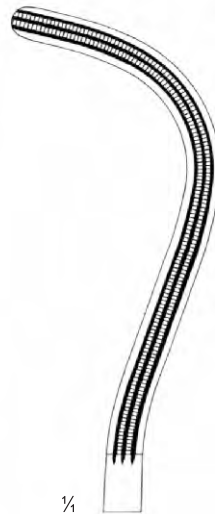


GUYON
 Ai 11-2677-23
 23 cm/9"

ATRAUMA



GUYON
 ATRAUMA

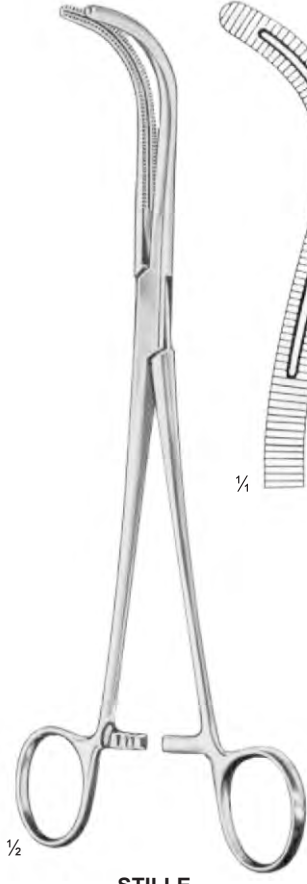


Ai 11-2678-23
 23 cm/9"

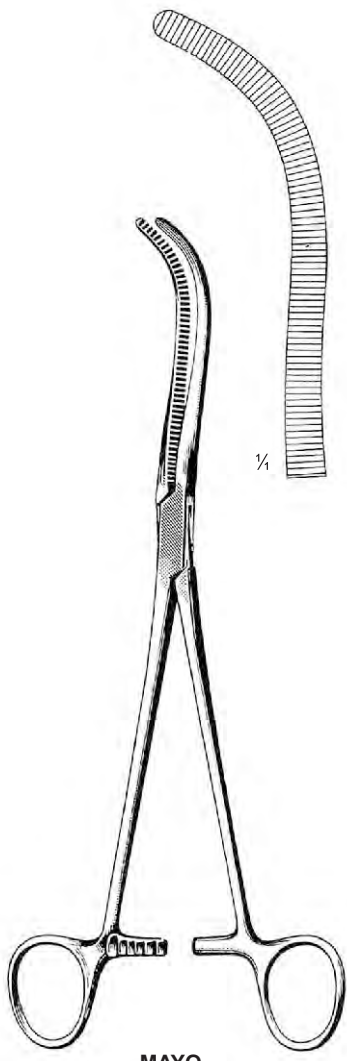


Ai 11-2678-24
 24 cm/9 1/2"

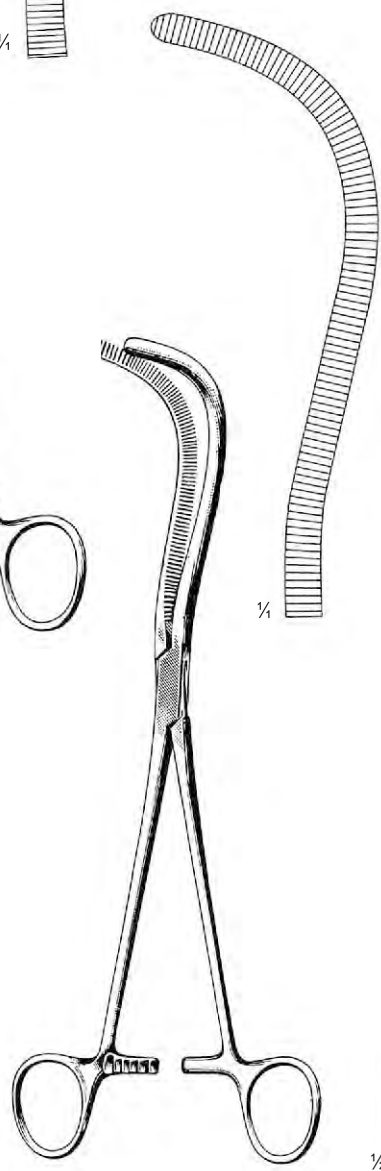




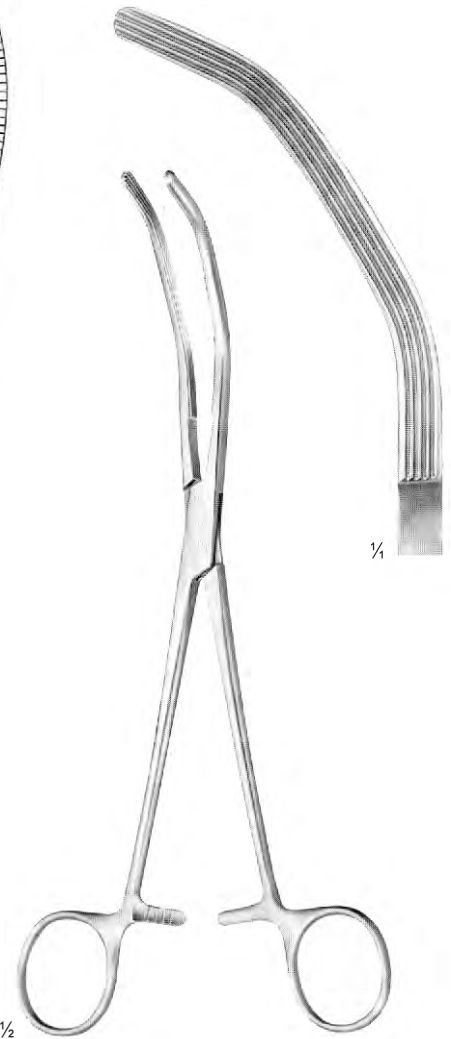
STILLE
 Ai 11-2679-23
 23 cm/9"



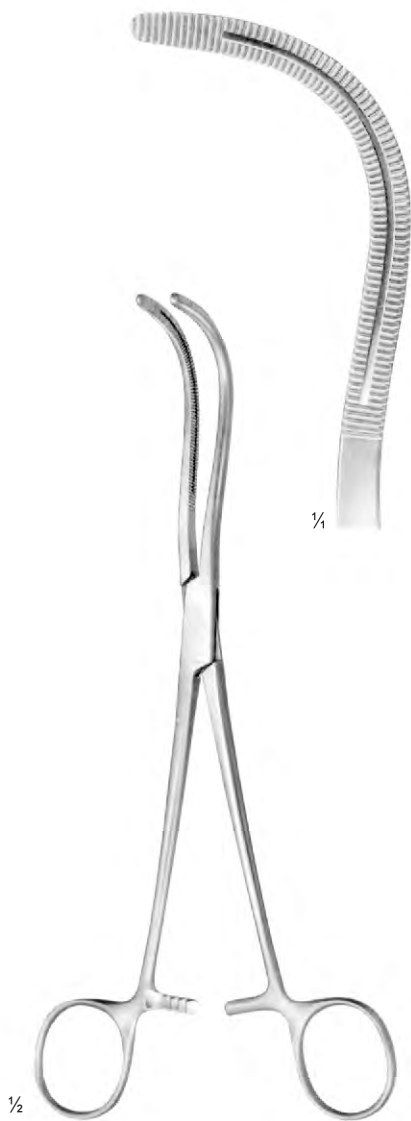
MAYO
 Ai 11-2680-23
 23 cm/9"



MAYO-GUYON
 Ai 11-2681-23
 23 cm/9"



HERRICK
 Ai 11-2682-23
 23 cm/9"



STILLE
 Ai 11-2683-22
 22 cm/8 1/2"



STILLE
 Ai 11-2684-24
 24 cm/9 1/2"
 Screw Joint



GUYON
 Ai 11-2685-26
 26.5 cm/10 3/8"





GRAY

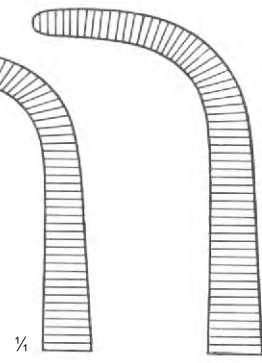


Fig. 1
 Ai 11-2687-22
 22 cm/8 1/2"
 2
 Ai 11-2687-23
 23 cm/9"



GRAY
 1:2

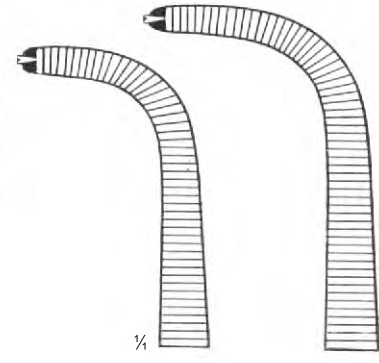
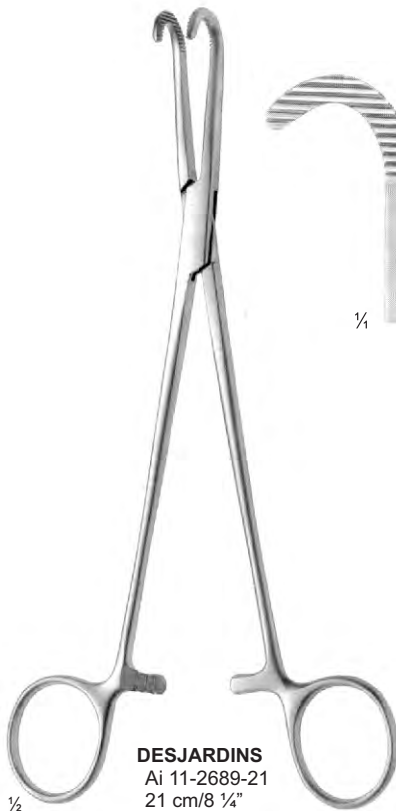


Fig. 1
 Ai 11-2688-22
 22 cm/8 1/2"
 2
 Ai 11-2688-23
 23 cm/9"

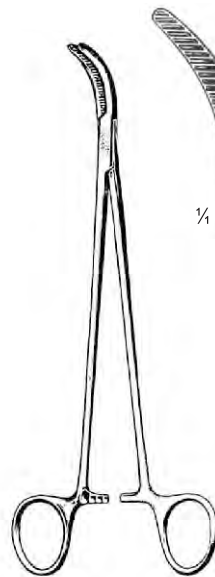


1/2

DESJARDINS
 Ai 11-2689-21
 21 cm/8 1/4"



1/4



DESJARDINS
 Ai 11-2690-21
 21 cm/8 1/4"



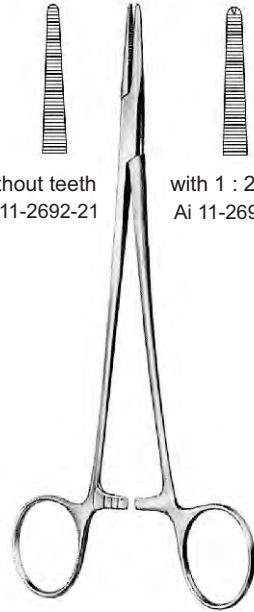
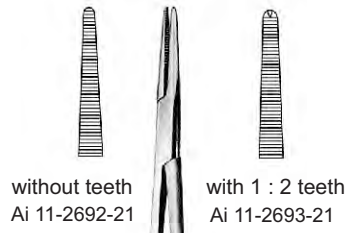
1/4



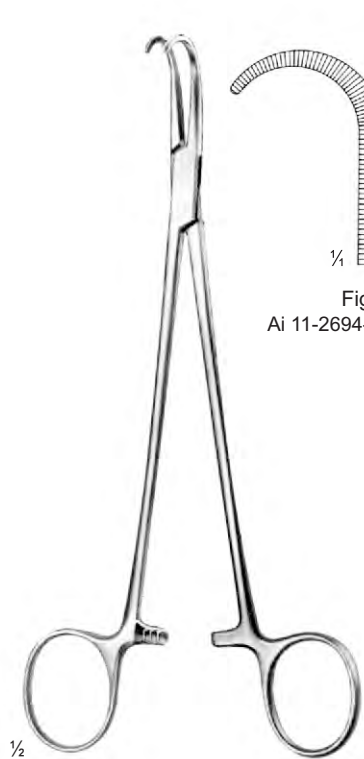
CRILE
 Ai 11-2691-20
 20 cm/7 7/8"



1/4



HOSEMANN
 21 cm/8 1/4"



NEGUS
 19 cm/7 1/2"

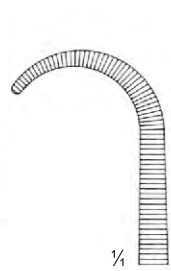
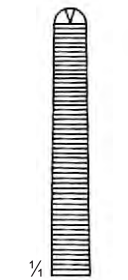


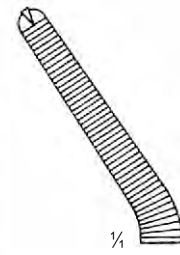
Fig. 1
 Ai 11-2694-19



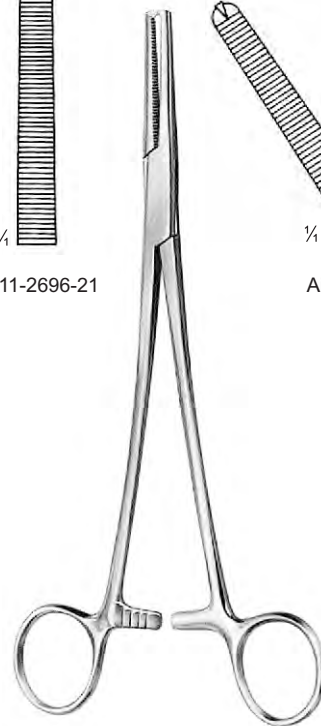
Fig. 2
 Ai 11-2695-19



Ai 11-2696-21



Ai 11-2697-21



PHANEUF
 21.5 cm/8 1/2"
 1 : 2





1 Tooth	HEANEY	2 Teeth
Ai 11-2698-19	19.5 cm/7 1/2"	Ai 11-2699-19
Ai 11-2698-21	21.0 cm/8 1/4"	Ai 11-2699-21
Ai 11-2698-23	23.0 cm/9"	Ai 11-2699-23

WERTHEIM-CULLEN
 Ai 11-2700-21
 21.5 cm/8 1/2"

WERTHEIM
 Ai 11-2701-24
 24 cm/9 1/2"
 Extra Strong



ROGERS

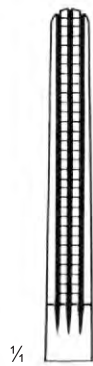


Fig. 1
 Ai 11-2702-21
 21.5 cm/8 1/2"



Fig. 2
 Ai 11-2703-21
 21 cm/8 1/4"



Fig. 3
 Ai 11-2704-20
 20.5 cm/8 1/8"



Fig. 4
 Ai 11-2705-20
 20 cm/7 3/8"

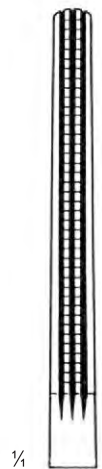


Fig. 1
 Ai 11-2706-25
 25.5 cm/10"



Fig. 2
 Ai 11-2707-25
 25 cm/9 7/8"

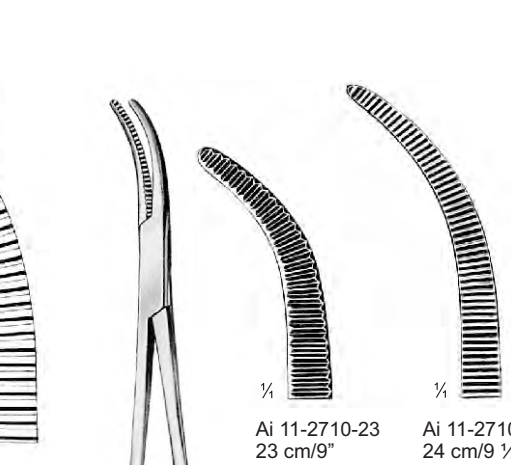


Fig. 3
 Ai 11-2708-24
 24.5 cm/9 5/8"





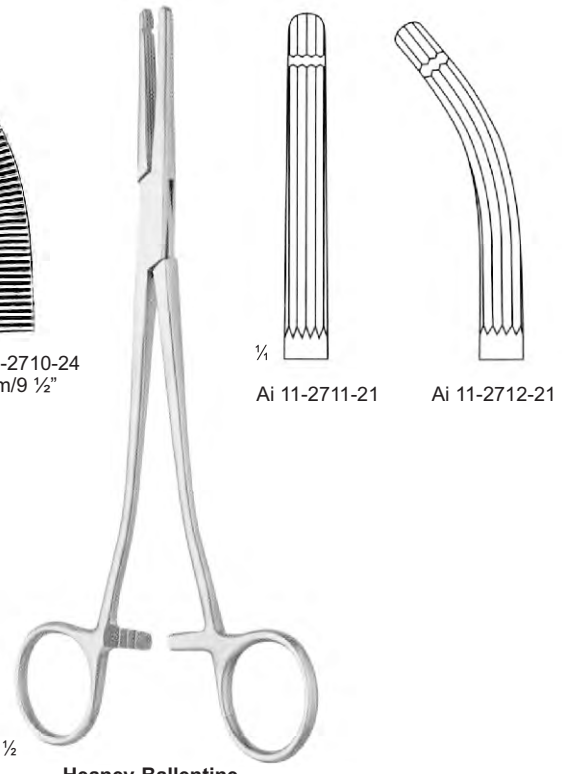
WERTHEIM
Ai 11-2709-25
25 cm/9 7/8"



MOYNIHAN

1/4
Ai 11-2710-23
23 cm/9"

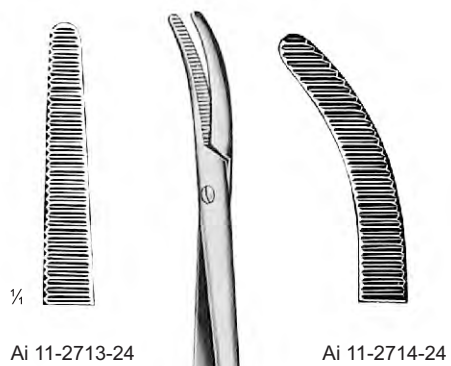
1/4
Ai 11-2710-24
24 cm/9 1/2"



Heaney-Ballentine
21 cm/8 1/4"

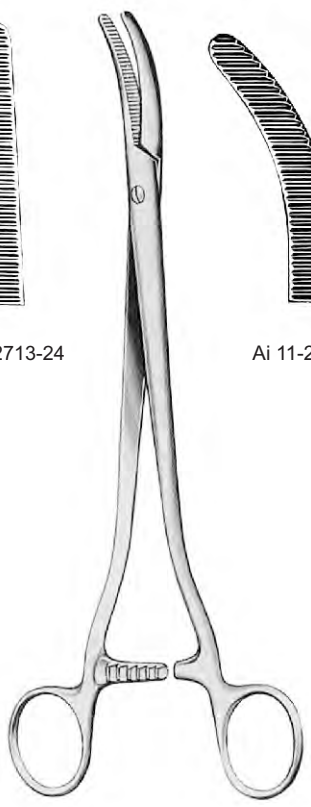
1/4
Ai 11-2711-21

Ai 11-2712-21

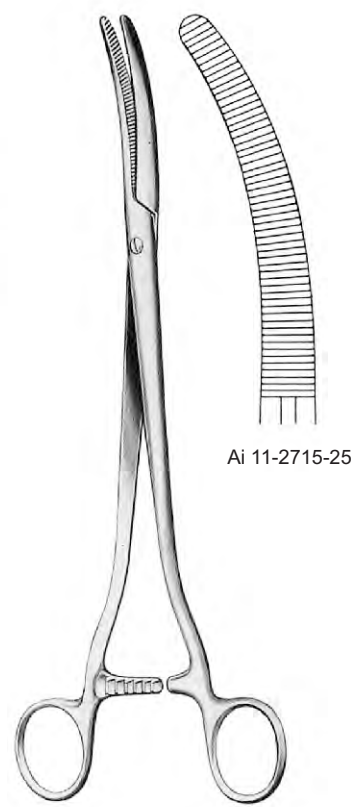


1/4
Ai 11-2713-24

Ai 11-2714-24



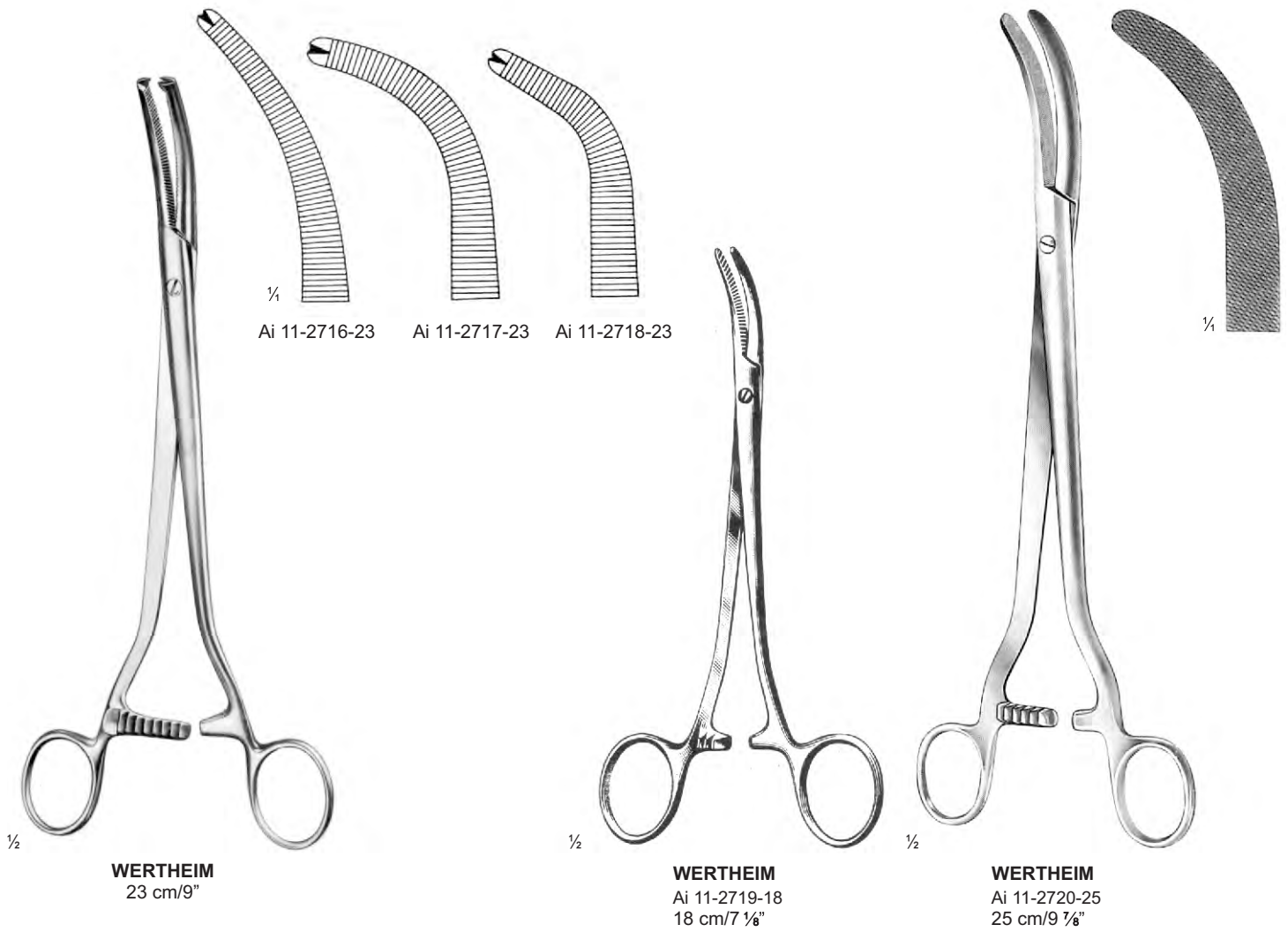
SEGOND-LANDAU
24 cm/9 1/2"

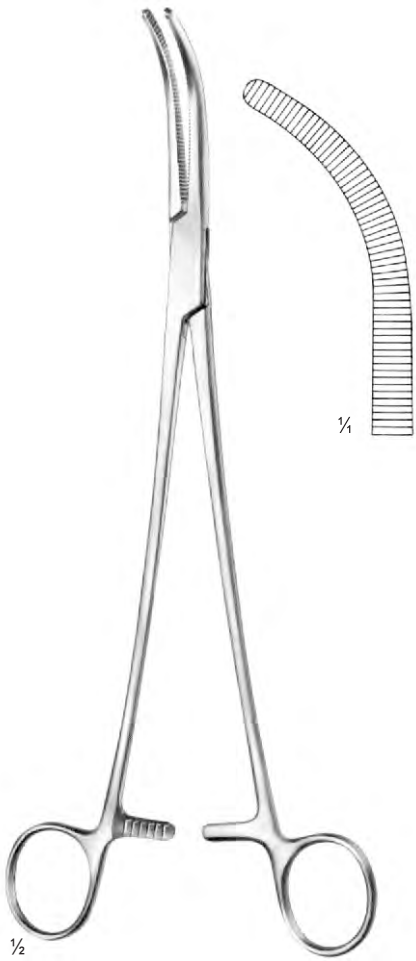


FAURE
25 cm/9 7/8"

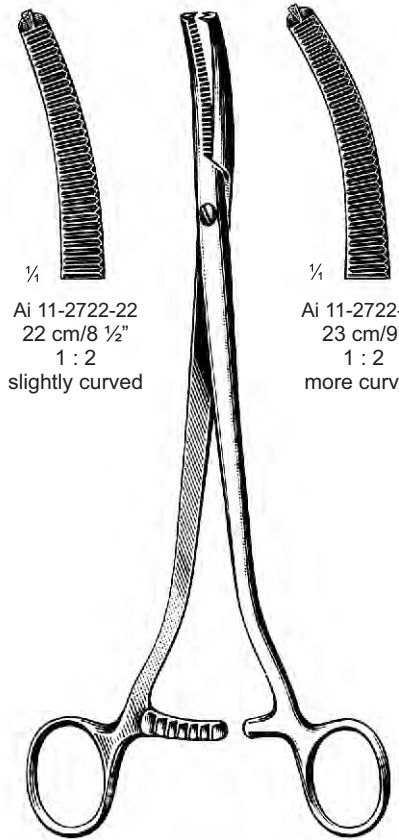
Ai 11-2715-25

Heavy pattern



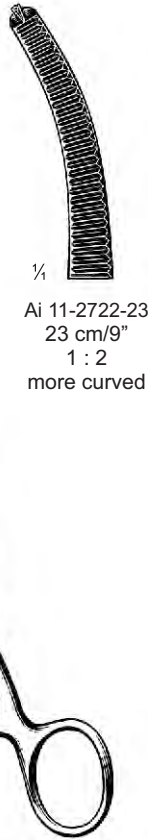


WERTHEIM
 Ai 11-2721-25
 25 cm/9 7/8"

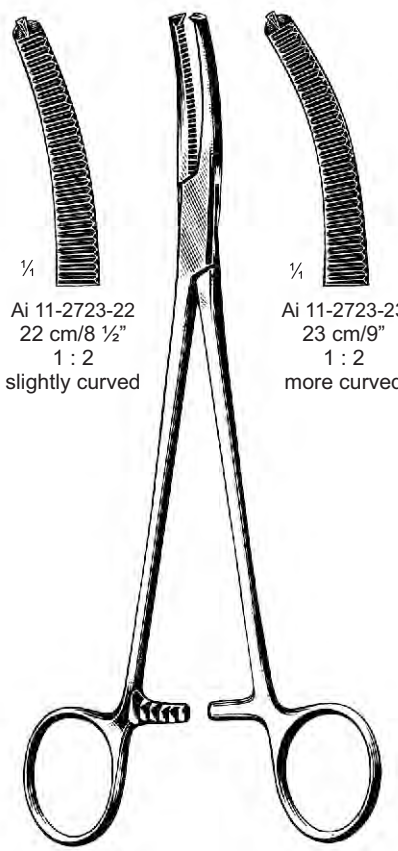


1/4
 Ai 11-2722-22
 22 cm/8 1/2"
 1 : 2
 slightly curved

WERTHEIM



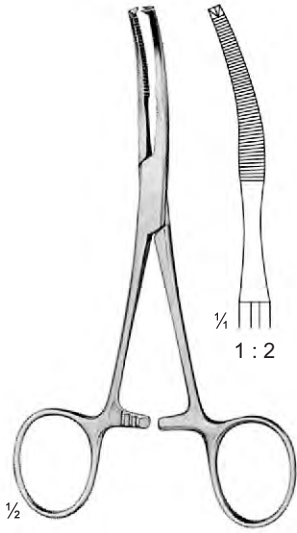
1/4
 Ai 11-2722-23
 23 cm/9"
 1 : 2
 more curved



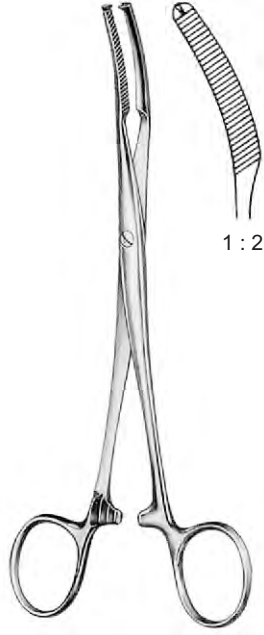
1/4
 Ai 11-2723-22
 22 cm/8 1/2"
 1 : 2
 slightly curved

WERTHEIM

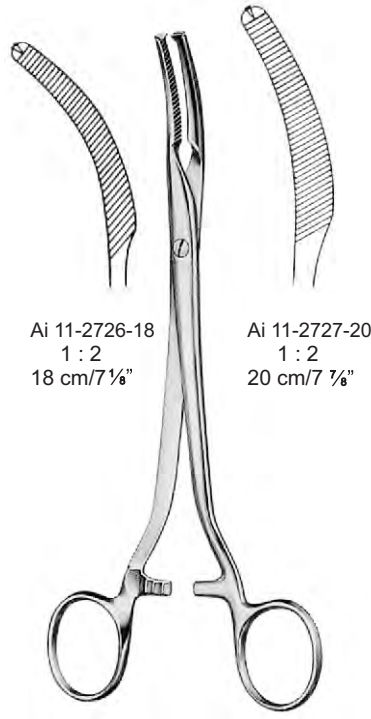
1/4
 Ai 11-2723-23
 23 cm/9"
 1 : 2
 more curved



BABY-MIKULICZ
 Ai 11-2724-14
 14 cm/5 1/2"

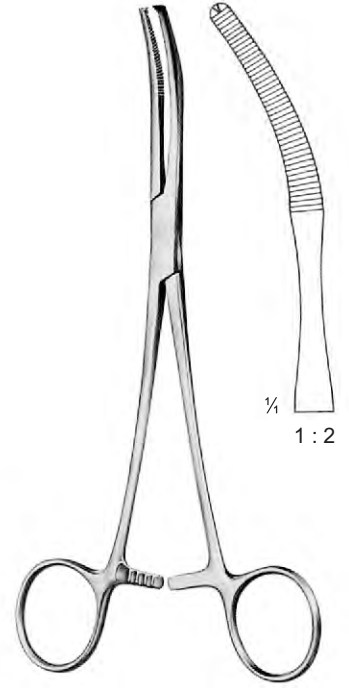


MIKULICZ
 Ai 11-2725-18 18 cm/7 1/8"
 Ai 11-2725-20 20 cm/7 7/8"

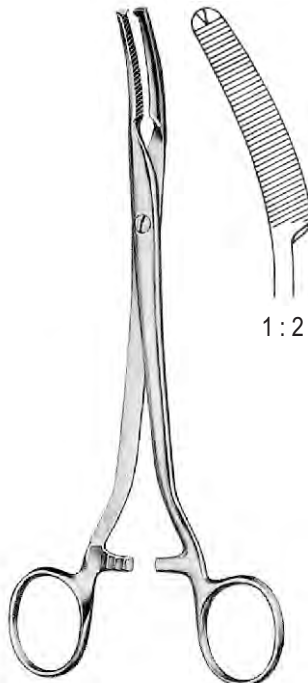


Ai 11-2726-18
 1:2
 18 cm/7 1/8"

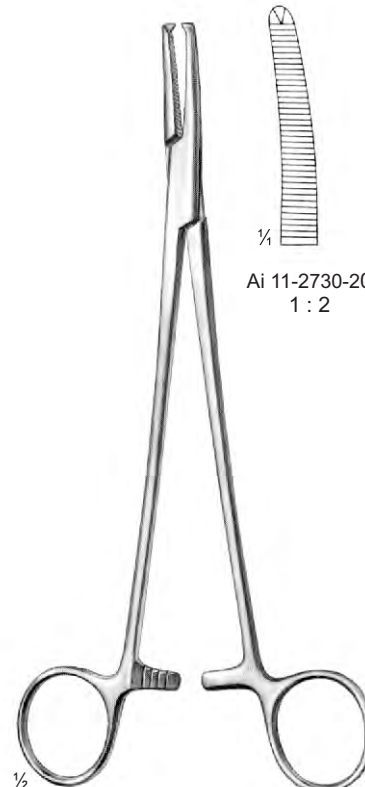
Ai 11-2727-20
 1:2
 20 cm/7 7/8"



MIKULICZ
 Ai 11-2728-20 20 cm/7 7/8"



MIKULICZ
 Ai 11-2729-20
 20.5 cm/8 1/8"



FAURE
 20 cm/7 7/8"

Ai 11-2730-20
 1:2

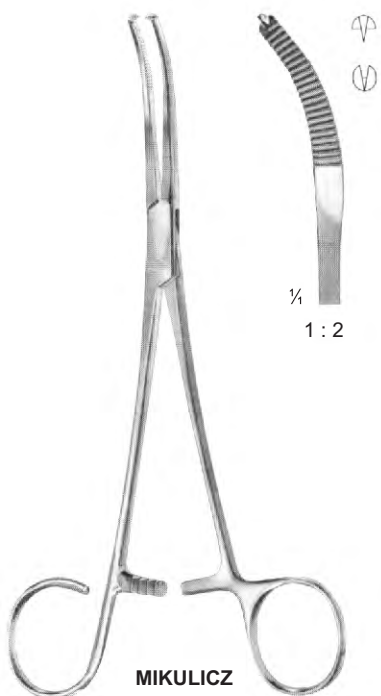
Ai 11-2731-20
 1:2





1/2

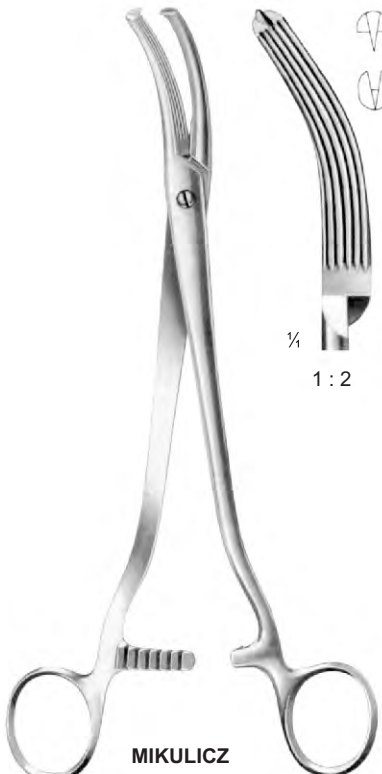
MIKULICZ
 Ai 11-2732-18
 18 cm/7 1/8"



1/4
 1:2

1/2

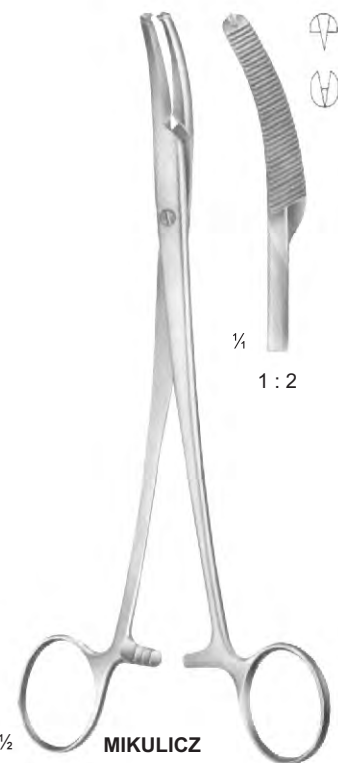
MIKULICZ
 Ai 11-2733-20
 20 cm/7 7/8"



1/4
 1:2

1/2

MIKULICZ
 Ai 11-2734-20
 20.5 cm/8 1/8"



1/4
 1:2

1/4

1:2

1/2

MIKULICZ
 Ai 11-2735-18
 18.5 cm/7 1/4"

MIKULICZ
 Ai 11-2736-24
 24.5 cm/9 5/8"

1/2

MIKULICZ
 Ai 11-2737-20
 20 cm/7 7/8"



SCHAEDEL
 Ai 11-2738-09
 9 cm/3 1/2"



ENGL. MODELL
 Ai 11-2739-09
 9 cm/3 1/2"



JONES
 Ai 11-2740-05 5 cm/2"
 Ai 11-2740-09 9 cm/3 1/2"



JONES
 Ai 11-2741-09
 9 cm/3 1/2"



DOYEN
 Ai 11-2742-11
 11 cm/4 3/8"



DOYEN
 Ai 11-2743-18
 18 cm/7 1/8"

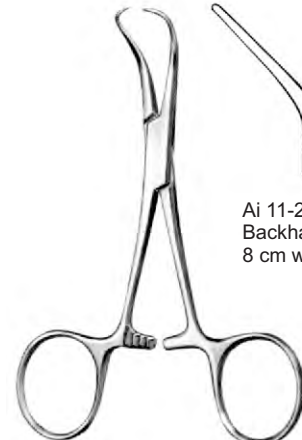
With Clip for Tubing or Cable



BACKHAUS
 Ai 11-2744-11 11 cm/4 3/8"
 Ai 11-2744-13 13 cm/5 1/8"
 Delicate pattern, sharp



BACKHAUS
 Ai 11-2745-11
 11 cm/4 3/8"
 With Clip for Tubing or Cable



BACKHAUS
 Ai 11-2747-08 Backhaus Towel
 8 cm with open jaws
 Ai 11-2746-08 8 cm/3 1/4"
 Ai 11-2746-08 11 cm/4 3/8"
 Ai 11-2746-08 13 cm/5 1/8"
 Ai 11-2746-08 15 cm/5 7/8"

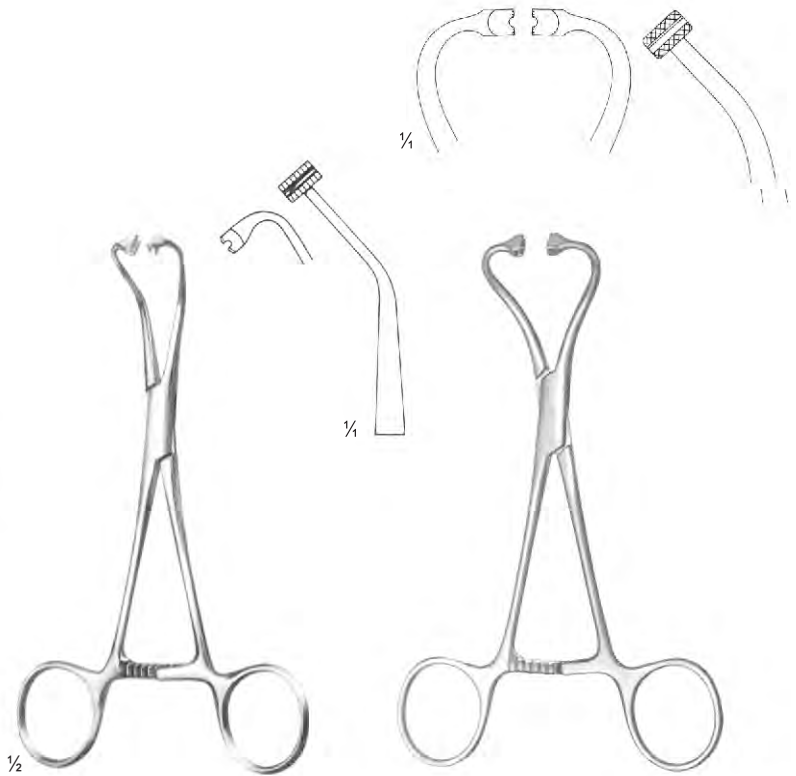




BALL & SOCKET
 Ai 11-2748-11 11.5 cm/4 1/2"
 Ai 11-2748-14 14 cm/5 1/2"

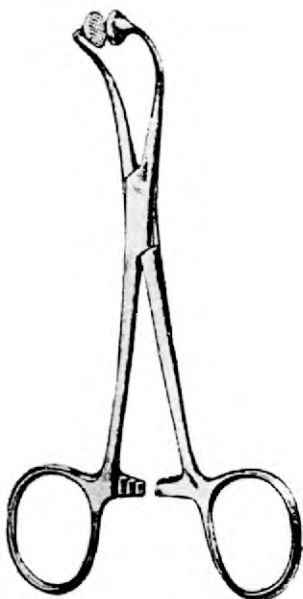


TOHOKU
 Ai 11-2749-10 10.5 cm/4 1/8"
 Ai 11-2749-13 13.5 cm/5 3/8"



PEERS BERTRAM
 Ai 11-2750-14 14.5 cm/5 3/4"

PEERS-BERTRAM MODIF.
 Ai 11-2751-15 15.5 cm/6 1/8"



HOFF
 Ai 11-2752-11 11 cm/4 3/8"
 Ai 11-2752-14 14.5 cm/5 3/4"



ROBIN
 Ai 11-2753-13 13.5 cm/5 3/8"
 with holder for cable up to 5 mm



ROBIN
 Ai 11-2754-13 13.5 cm/5 3/8"
 with holder for cable up to 13 mm tubing



PAPER TOWEL FORCEPS
 Ai 11-2755-10 10 cm/3 7/8"
 Ai 11-2755-13 13 cm/5 1/8"



ROEDER
 Ai 11-2756-13 13 cm/5 1/8"
 Ai 11-2756-15 15 cm/5 7/8"



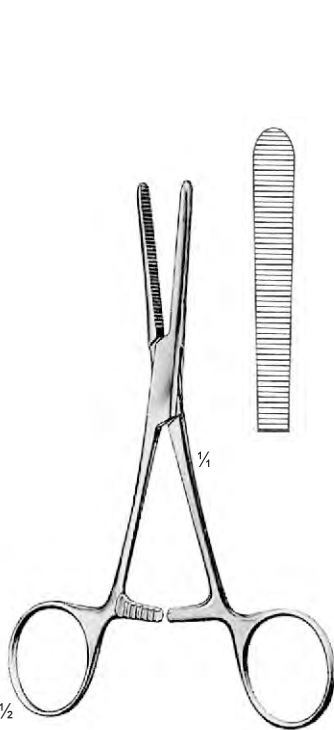
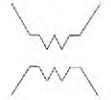
LORNA
 Ai 11-2757-10 10 cm/3 7/8"
 Ai 11-2757-13 13 cm/5 1/8"



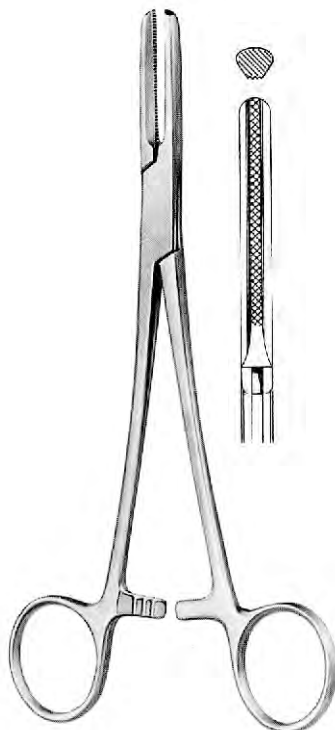
BERNHARD
 Ai 11-2758-16
 16.5 cm/6 1/2"



LANE
 Ai 11-2759-20
 20 cm/7 7/8"



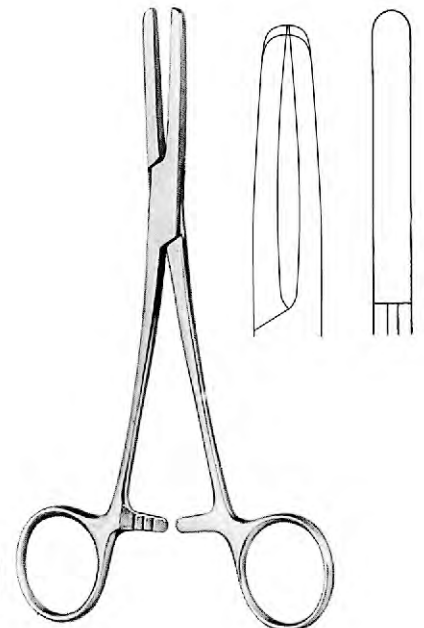
Ai 11-2760-14
 14.5 cm/5 3/4"
 with extra long ratchet



SCHOENBERG
 Ai 11-2761-15 15.5 cm/6 1/8"
 Ai 11-2761-19 19 cm/7 1/2"
 Ai 11-2761-20 20 cm/7 7/8"



SCHOENBERG
 Ai 11-2762-15 15.5 cm/6 1/8"
 Ai 11-2762-19 19 cm/7 1/2"
 Ai 11-2762-20 20 cm/7 7/8"
 with safety guard



PRESBYTERIAN-HOSPITAL
 Ai 11-2763-15 15.5 cm/6 1/8"
 Ai 11-2763-19 19 cm/7 1/2"
 Ai 11-2763-20 20 cm/7 7/8"



LISTER
 Ai 11-2764-20
 20 cm/7 7/8"



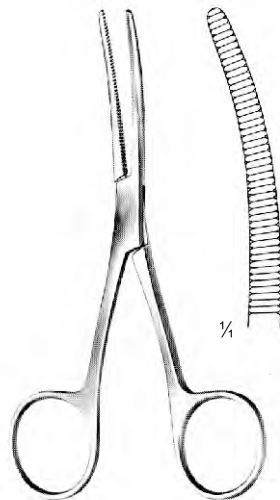
Ai 11-2764-13
 13 cm/5 1/8"



Ai 11-2764-15
 15 cm/5 7/8"



Ai 11-2764-18
 18 cm/7 1/8"

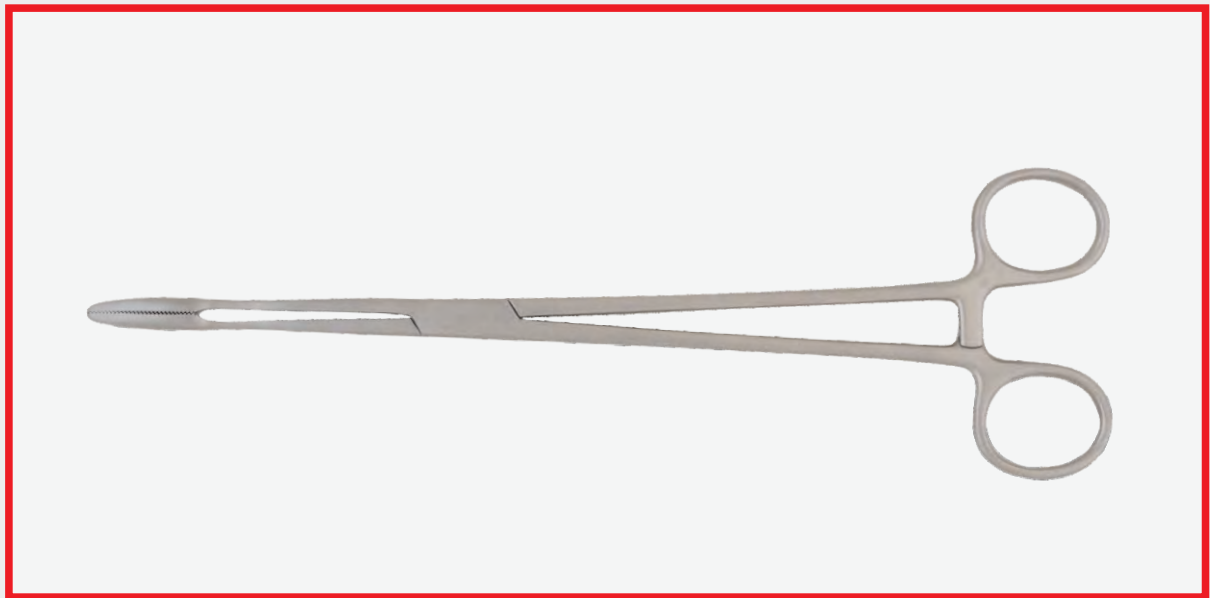


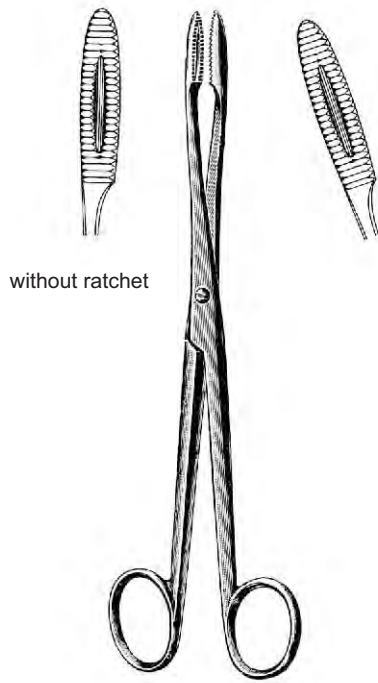
BRYANT
 Ai 11-2765-13
 13 cm/5 1/8"



- EN** Cotton Swab Forceps
- DE** Tupfer-und Kornzangen
- ES** Pinzas para tapones y curaciones

Page 158 to 163

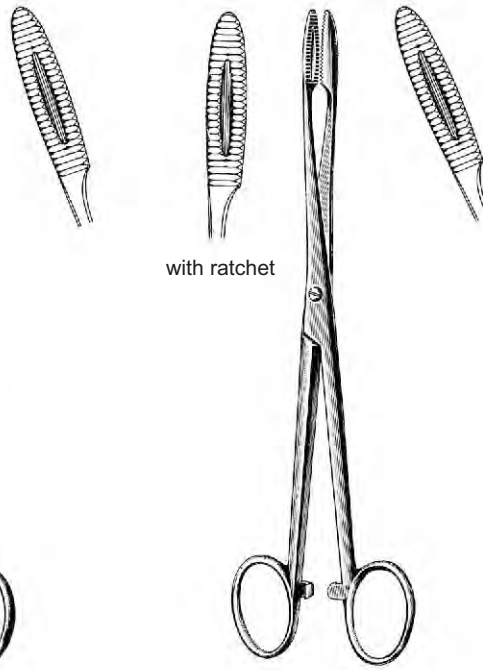




without ratchet

GROSS-MAIER

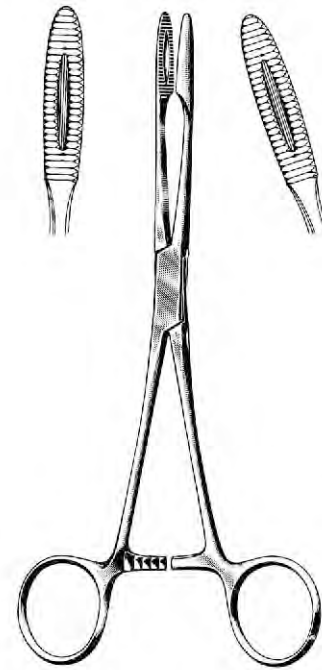
straight	curved	cm	in
		14.5	5 3/4"
Ai 12-2801-16	Ai 12-2802-16	16	6 1/4"
Ai 12-2801-18	Ai 12-2802-18	18	7 1/8"
Ai 12-2801-20	Ai 12-2802-20	20	7 7/8"
Ai 12-2801-25	Ai 12-2802-25	25	9 7/8"



with ratchet

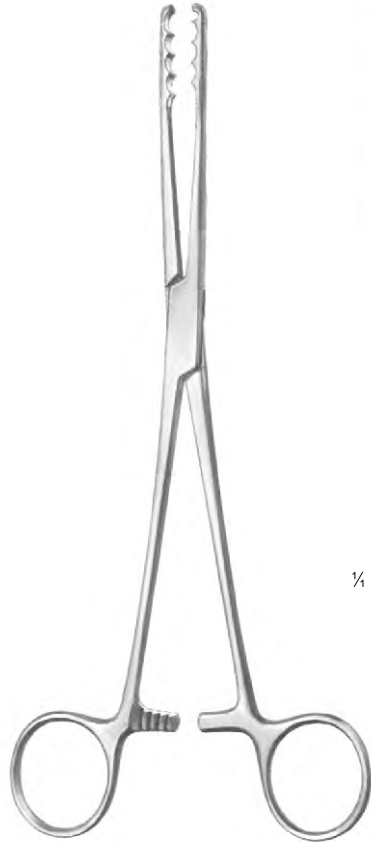
GROSS-MAIER

straight	curved
Ai 12-2803-14	Ai 12-2804-14
Ai 12-2803-16	Ai 12-2804-16
Ai 12-2803-18	Ai 12-2804-18
Ai 12-2803-20	Ai 12-2804-20
Ai 12-2803-25	Ai 12-2804-25

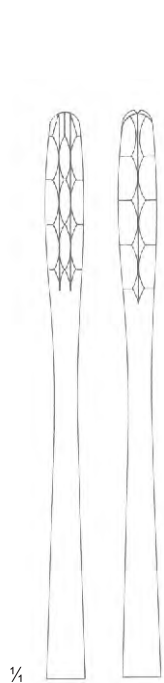


GROSS-MAIER

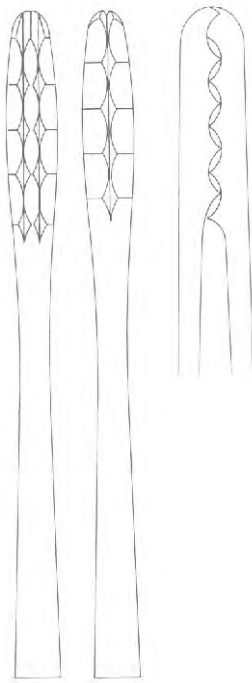
straight	curved
Ai 12-2805-20	20 cm/7 7/8" Ai 12-2806-20
Ai 12-2805-22	22 cm/8 1/2" Ai 12-2806-22
Ai 12-2805-25	25 cm/9 7/8" Ai 12-2806-25



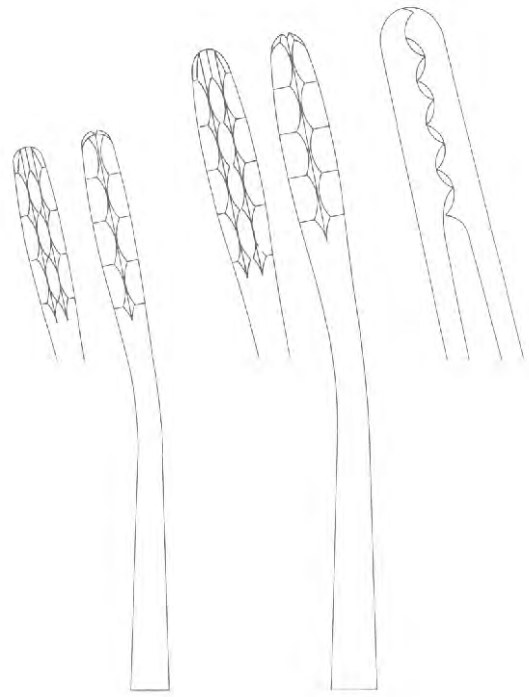
ULRICH



Ai 12-2807-22
 22.5 cm/8 3/4"



Ai 12-2807-26
 26.5 cm/10 3/8"



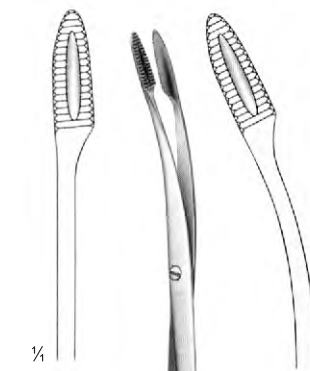
Ai 12-2808-22
 22.5 cm/8 3/4"

Ai 12-2808-26
 26.5 cm/10 3/8"



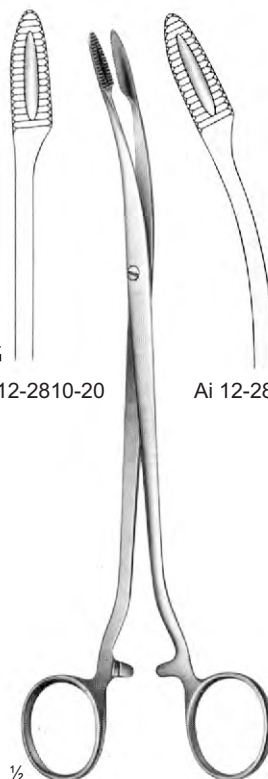
EMMET

Ai 12-2809-21
 21 cm/8 1/4"



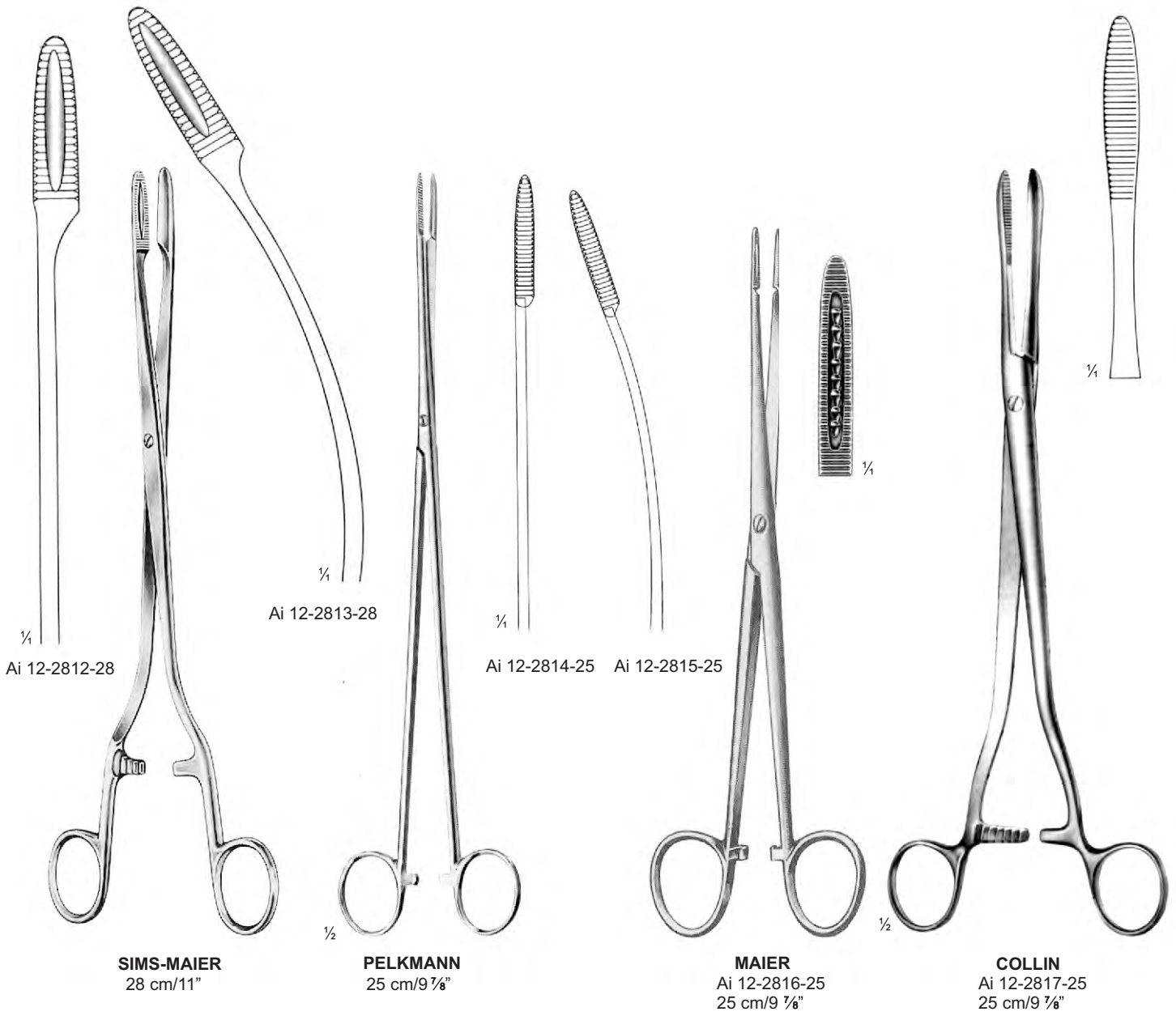
Ai 12-2810-20

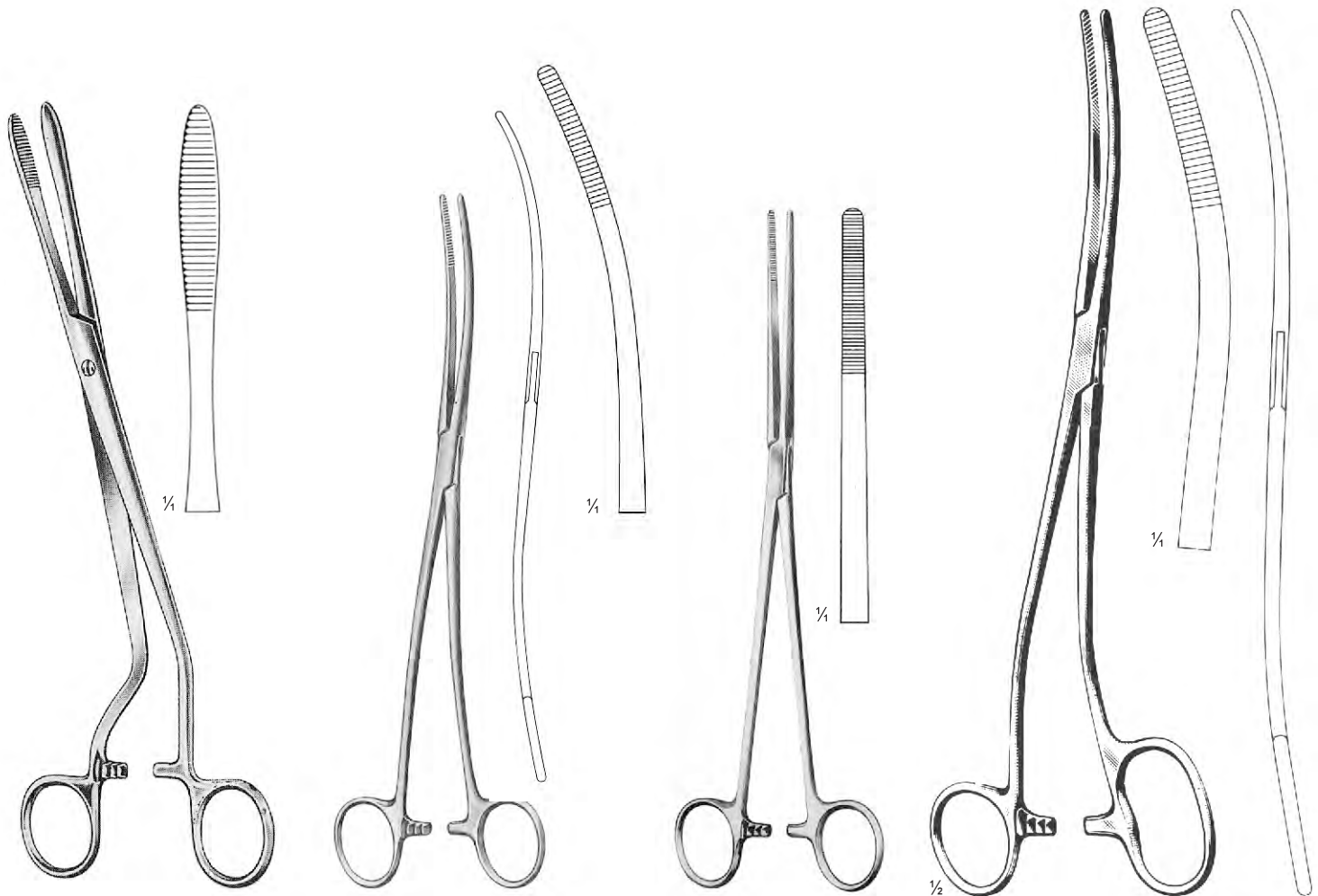
Ai 12-2811-20



DUPLAY
 20 cm/7 7/8"







CHERON

Ai 12-2818-25
 25 cm/9 7/8"

BOZEMANN

Ai 12-2819-26
 26 cm/10 1/4"
 S-shaped

BOZEMANN

Ai 12-2820-26
 26 cm/10 1/4"

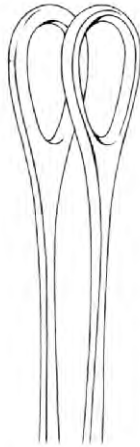
BOZEMANN DOUGLAS

Ai 12-2821-26
 26 cm/10 1/4"

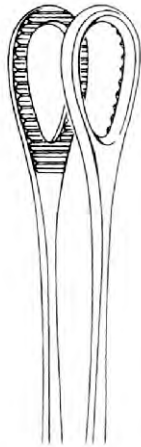


FOERSTER

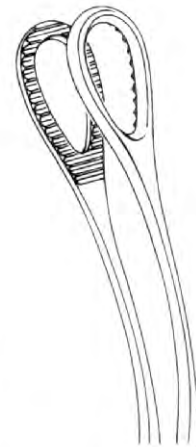
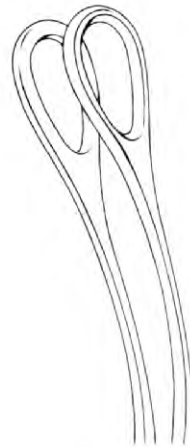
18 cm/7 1/8" Ai 12-2822-18
 20 cm/7 7/8" Ai 12-2822-20
 25 cm/9 7/8" Ai 12-2822-25



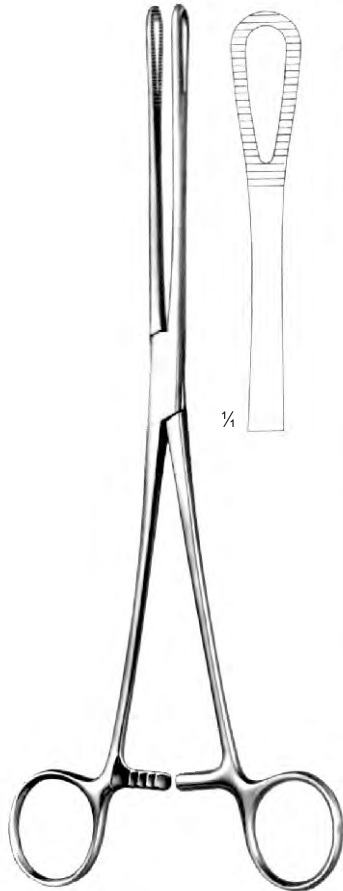
Ai 12-2823-18
 Ai 12-2823-20
 Ai 12-2823-25



Ai 12-2824-18
 Ai 12-2824-20
 Ai 12-2824-25

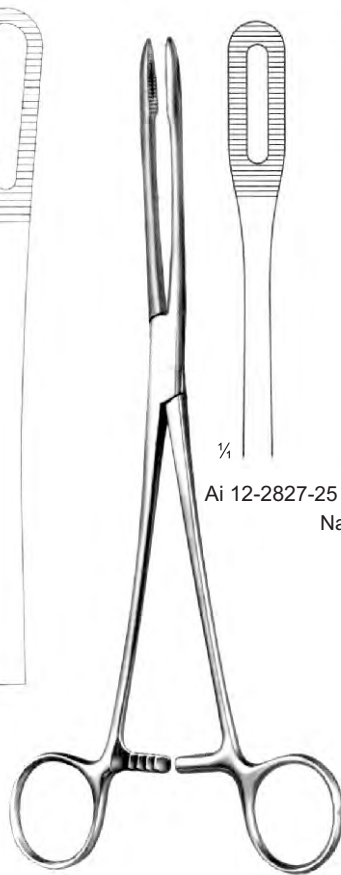


Ai 12-2825-18
 Ai 12-2825-20
 Ai 12-2825-25



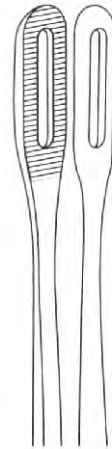
RAMPLEY

Ai 12-2826-18 18.5 cm/7 1/4"
 Ai 12-2826-24 24.5 cm/9 5/8"

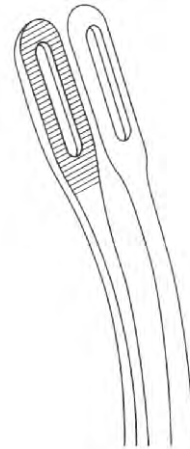


FOERSTER

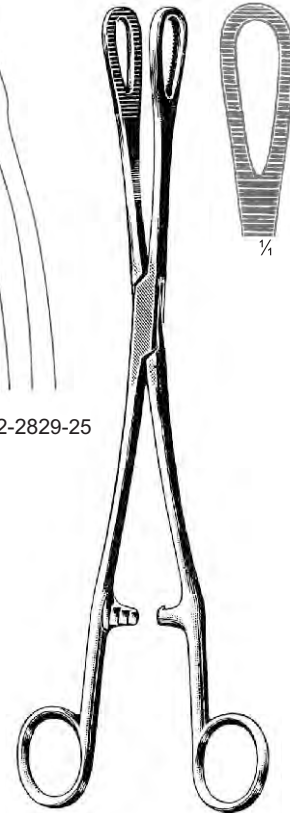
25 cm/9 7/8"



Ai 12-2827-25 Ai 12-2828-25
 Narrow



Ai 12-2829-25

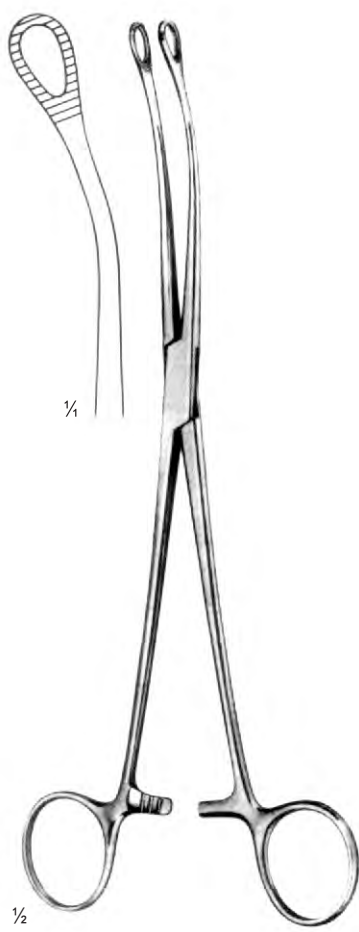


RAMPLEY

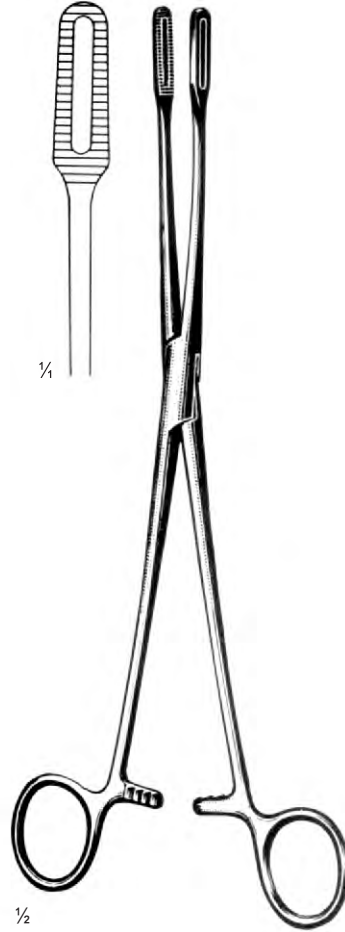
Ai 12-2830-25
 25 cm/9 7/8"



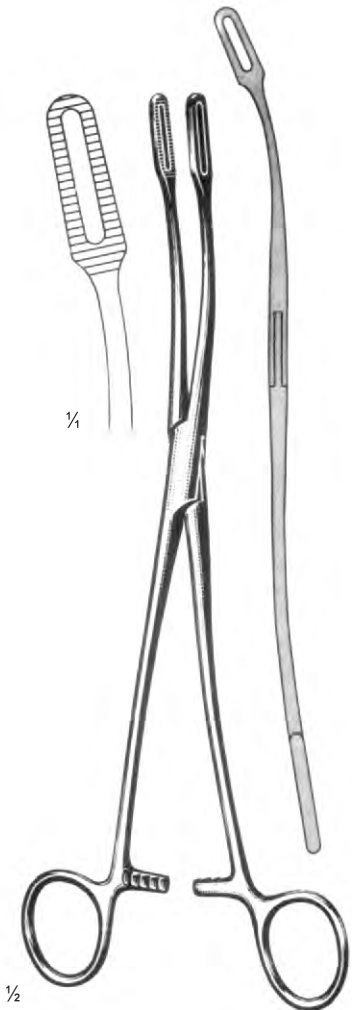
BERGMANN-FOERSTER
 Ai 12-2831-24
 24 cm/9 1/2"



BERGMANN-FOERSTER
 Ai 12-2832-24
 24 cm/9 1/2"



FLETCHER (JAVERTS)
 Ai 12-2833-24
 24 cm/9 1/2"



FLETCHER (JAVERTS)
 Ai 12-2834-24
 24 cm/9 1/2"



EN

Probes, Applicators, Spatulas

DE

Sonden, Watteträger, Spatel






ES






Sondas, Porta-algodones, Espátulas

Page 164 to 169





					
	1mm	2mm			
11.5cm	Ai 13-2901-11	Ai 13-2902-11	Ai 13-2903-11		
12.5cm	Ai 13-2901-12	Ai 13-2902-12	Ai 13-2903-12	Ai 13-2904-12	Ai 13-2905-12
14.0cm	Ai 13-2901-14	Ai 13-2902-14	Ai 13-2903-14	Ai 13-2904-14	Ai 13-2905-14
16.0cm	Ai 13-2901-16	Ai 13-2902-16	Ai 13-2903-16	Ai 13-2904-16	Ai 13-2905-16
18.0cm	Ai 13-2901-18	Ai 13-2902-18	Ai 13-2903-18	Ai 13-2904-18	Ai 13-2905-18
20.0cm	Ai 13-2901-20	Ai 13-2902-20	Ai 13-2903-20	Ai 13-2904-20	Ai 13-2905-20
25.0cm	Ai 13-2901-25	Ai 13-2902-25	Ai 13-2903-25		

					
		Silver		FISH	FISH
10.5cm	Ai 13-2906-10	11.5cm Ai 13-2907-11	Ai 13-2908-11	Ai 13-2909-14	14.5cm Ai 13-2910-10
13.0cm	Ai 13-2906-13	12.5cm Ai 13-2907-12	Ai 13-2908-12	Ai 13-2909-18	18.0cm
14.5cm	Ai 13-2906-14	14.0cm Ai 13-2907-14	Ai 13-2908-14		
16.0cm	Ai 13-2906-16	16.0cm Ai 13-2907-16	Ai 13-2908-16		
18.0cm	Ai 13-2906-18	18.0cm Ai 13-2907-18	Ai 13-2908-18		
20.0cm	Ai 13-2906-20	20.0cm Ai 13-2907-20	Ai 13-2908-20		
		25.0cm Ai 13-2907-25	Ai 13-2908-25		



11.5cm Ai 13-2911-11
12.5cm Ai 13-2911-12
14.0cm Ai 13-2911-14
16.0cm Ai 13-2911-16
18.0cm Ai 13-2911-18
20.0cm Ai 13-2911-20



Ai 13-2912-11
Ai 13-2912-12
Ai 13-2912-14
Ai 13-2912-16
Ai 13-2912-18
Ai 13-2912-20



DOYEN
Ai 13-2913-14
14.0cm



NELATON
Ai 13-2914-16
16.0cm



Ai 13-2915-12
12.0cm



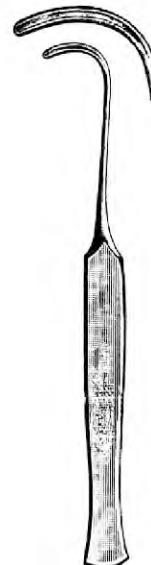
KRONECKER
Ai 13-2916-16
13.0 cm



JOHNS-HOPKINS
Ai 13-2917-15
15.0 cm



ROSER
Ai 13-2918-12
12.5 cm



SYME
Ai 13-2919-17
17.0 cm



Ai 13-2920-17
17.0 cm





Ai 13-2921-13 13.0 cm
 Ai 13-2921-14 14.5 cm



Ai 13-2922-17
 17.5 cm



MCDONALD
 Ai 13-2923-19
 19.0 cm



KILLIAN
 Ai 13-2924-19
 19.0 cm



WATSON CHEYENE
 Ai 13-2925-13 13.0 cm
 Ai 13-2925-19 19.0 cm



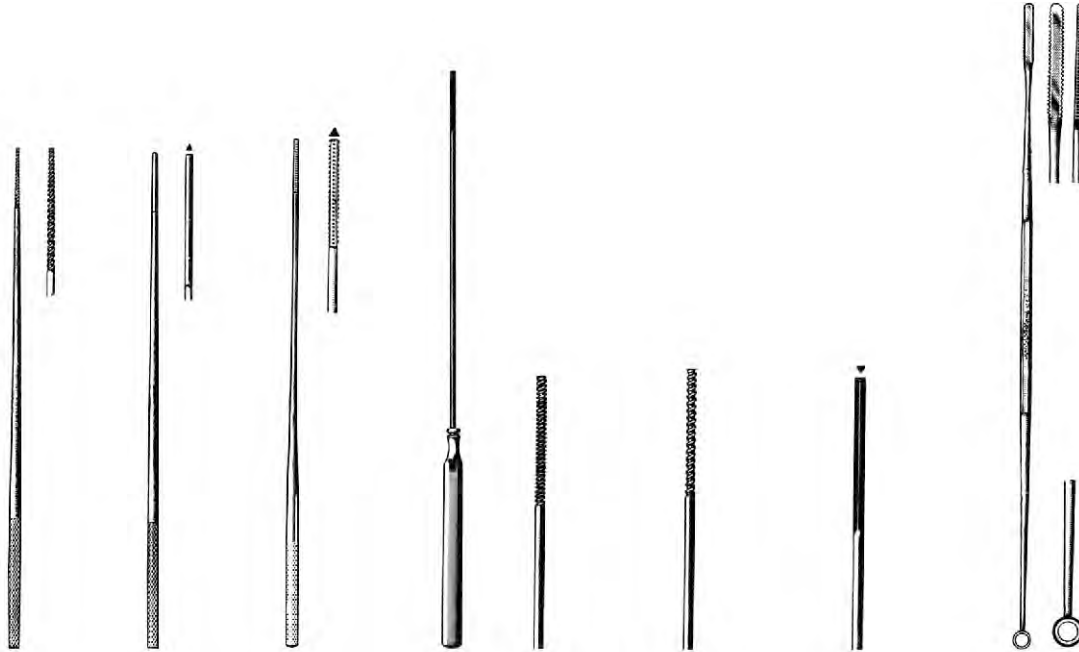
WATSON CHEYENE
 Ai 13-2926-17
 17.5 cm



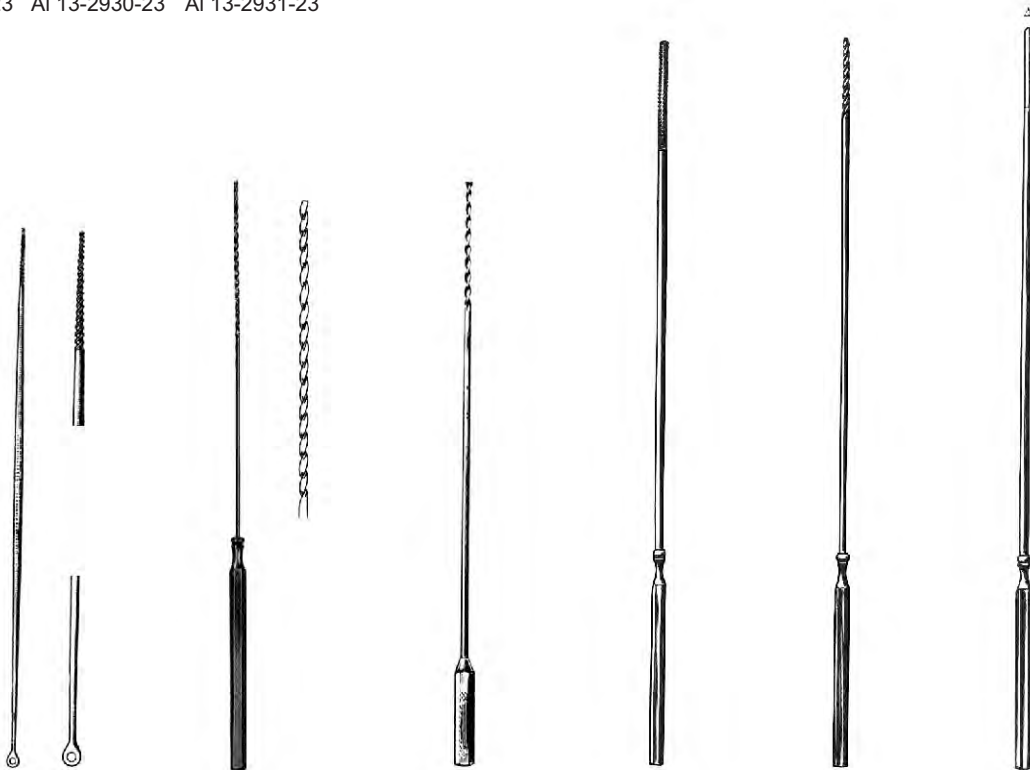
PLAYFAIR
 Ai 13-2927-31
 31.0 cm



CHEYENE
 Ai 13-2928-12 12.5 cm
 Ai 13-2928-17 17.5 cm



	FARREL						JOBSON-HORNE	
12.0cm	Ai 13-2929-12	Ai 13-2930-12	Ai 13-2931-12	Ai 13-2932-12	Ai 13-2933-12	Ai 13-2934-12	Ai 13-2935-12	12.5 cm
14.0cm	Ai 13-2929-14	Ai 13-2930-14	Ai 13-2931-14	Ai 13-2932-14	Ai 13-2933-14	Ai 13-2934-14	Ai 13-2935-18	18.0 cm
16.0cm	Ai 13-2929-16	Ai 13-2930-16	Ai 13-2931-16	Ai 13-2932-16	Ai 13-2933-16	Ai 13-2934-16		
18.0cm	Ai 13-2929-18	Ai 13-2930-18	Ai 13-2931-18	Ai 13-2932-18	Ai 13-2933-18	Ai 13-2934-18		
23.0cm	Ai 13-2929-23	Ai 13-2930-23	Ai 13-2931-23					

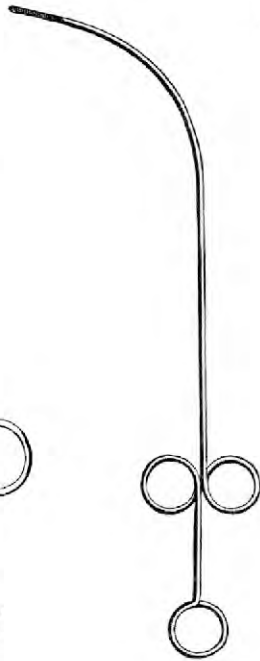


JOBSON-HORNE						
Ai 13-2936-15	Ai 13-2937-16	Ai 13-2938-25	Ai 13-2939-28	Ai 13-2940-28	Ai 13-2941-28	
15.0 cm	16.0 cm	25.0 cm	28.0 cm	28.0 cm	28.0 cm	





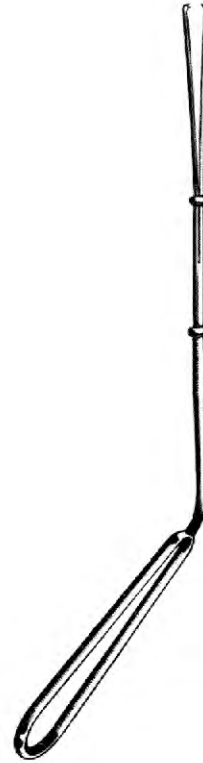
HARTMANN
 Ai 13-2942-20
 20.0 cm



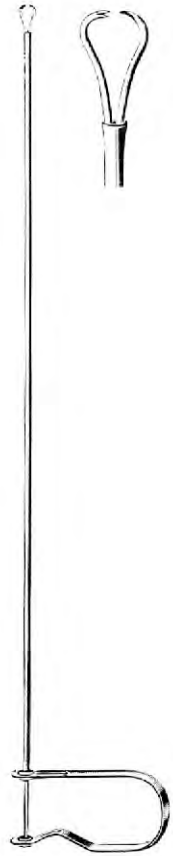
FEIN
 Ai 13-2943-28
 28.0 cm



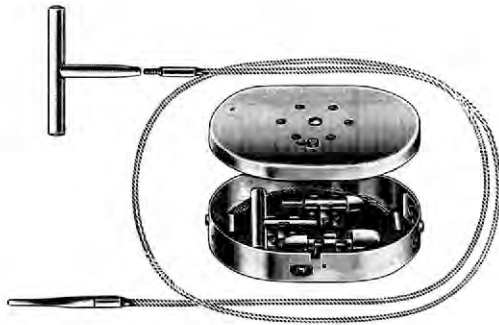
TOBOLD
 Ai 13-2944-25
 25.0 cm



Ai 13-2945-40
 40.0 cm



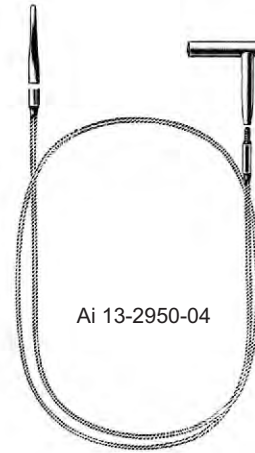
Ai 13-2946-45
 45.0 cm



NABATOFF
 Ai 13-2947-00
 complete set.
 135 x 100 x 25mm

Ai 13-2948-01

Ai 13-2949-02



Ai 13-2950-04



Ai 13-2951-03
 3.0mm Ø



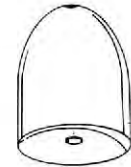
Ai 13-2951-06
 6.0mm Ø



Ai 13-2951-09
 9.0mm Ø



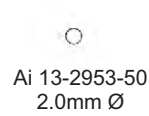
Ai 13-2951-12
 12.0mm Ø



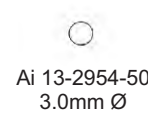
Ai 13-2951-15
 15.0mm Ø



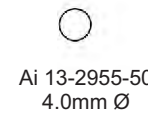
50.0 cm



Ai 13-2953-50
 2.0mm Ø



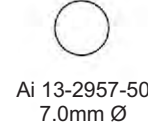
Ai 13-2954-50
 3.0mm Ø



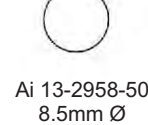
Ai 13-2955-50
 4.0mm Ø



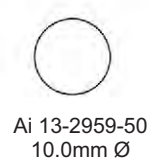
Ai 13-2956-50
 6.0mm Ø



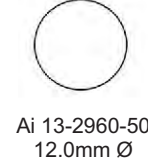
Ai 13-2957-50
 7.0mm Ø



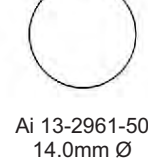
Ai 13-2958-50
 8.5mm Ø



Ai 13-2959-50
 10.0mm Ø



Ai 13-2960-50
 12.0mm Ø



Ai 13-2961-50
 14.0mm Ø



Ai 13-2952-12
 12.0 cm

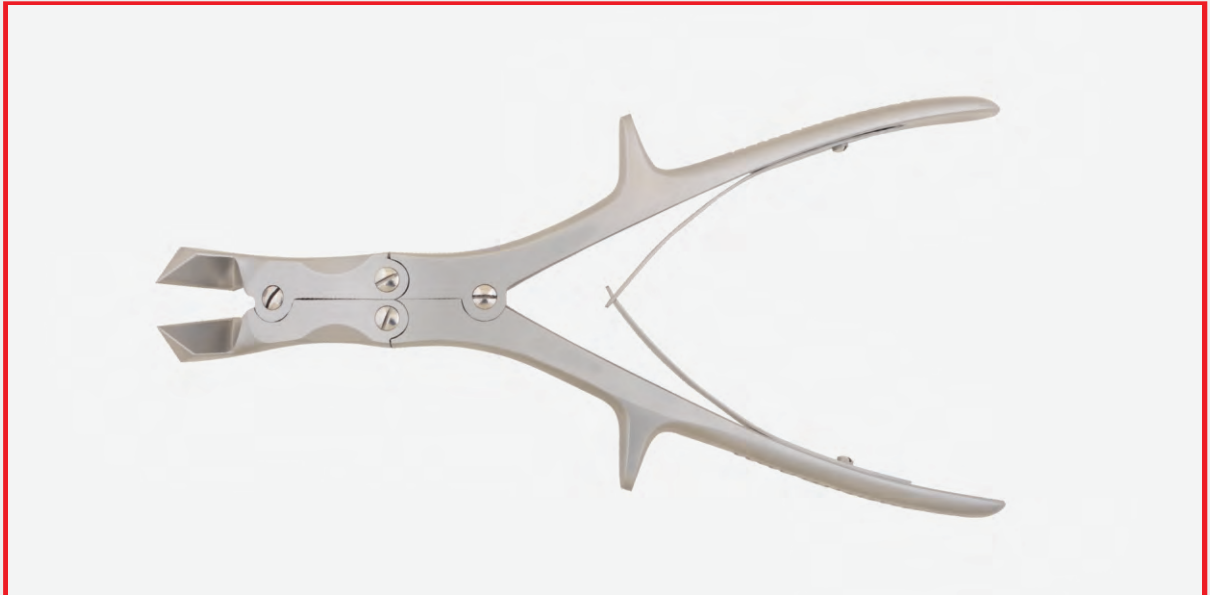


EN Bone Surgery

DE Knochenchirurgie

ES Cirugía ósea

Page 170 to 268

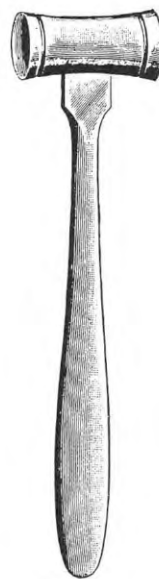




Mead
 Ai 14-3001-17 17 cm/6 1/2"
 26mm Ø, 320 g (11 1/4 oz)



Partsch
 Ai 14-3002-18 18 cm/7"
 22mm Ø, 200 g (7 oz)



Ai 14-3003-30
 30mm Ø, 510 g



Ai 14-3004-26 250 g
 Ai 14-3005-26 450 g
 26.5 cm/10 3/4"



Ai 14-3006-18 18.5 cm/7 1/2"
 25mm Ø 135 g



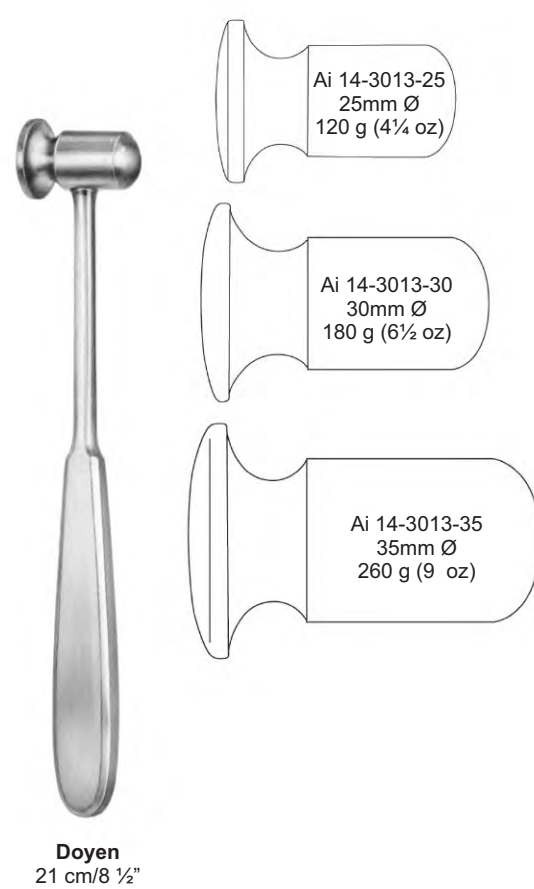
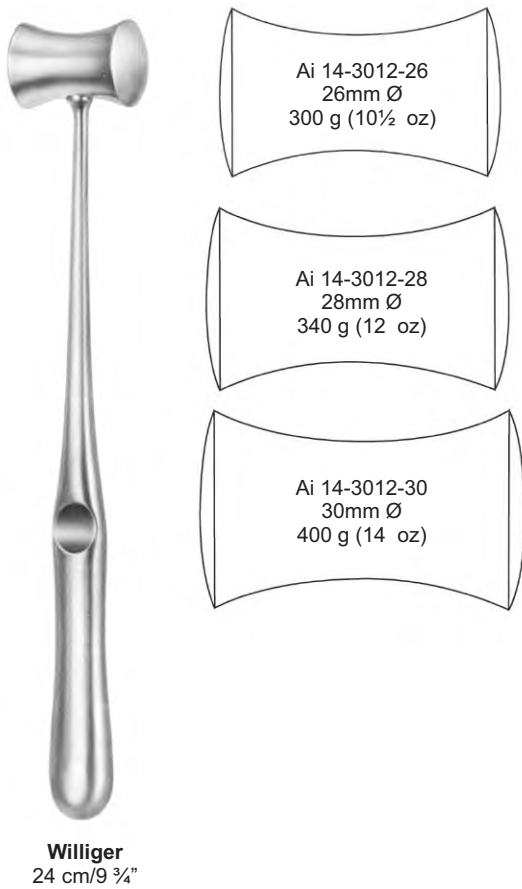
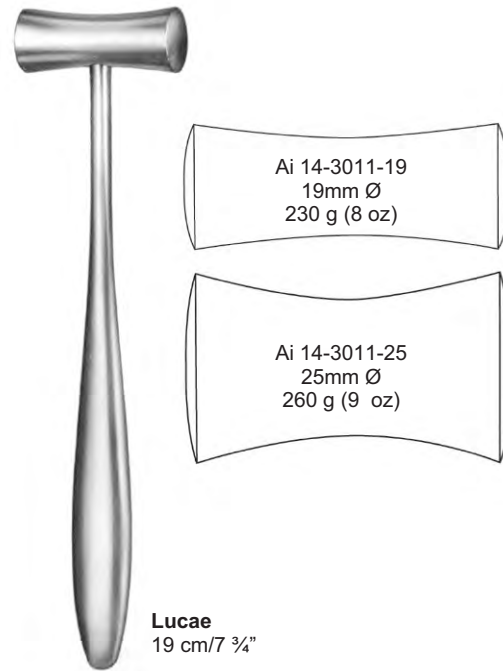
lead filled

Ai 14-3007-19 19 cm/7 3/4"
 22mm Ø 155 g



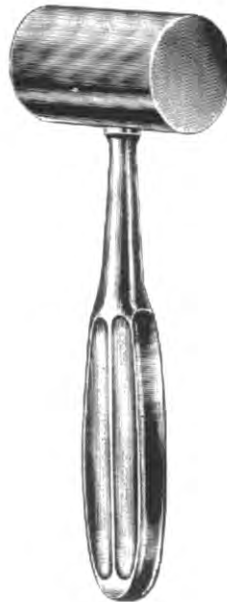
Hajek
 Ai 14-3008-22 22 cm/8 3/4"
 27mm Ø 130 g



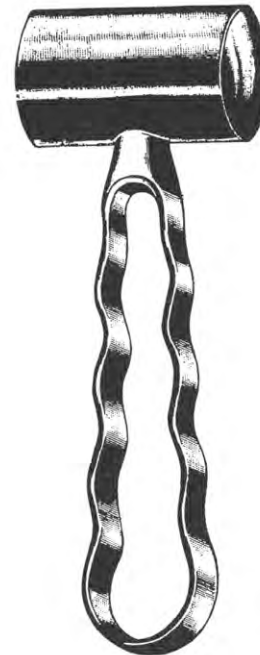




Gerzog
 Ai 14-3014-18
 18 cm/7"
 250 g



Kirk
 Ai 14-3015-19
 19 cm/7 1/2"
 750 g



Heath
 18 cm/7"
 Ai 14-3016-35 35mm Ø (28 oz)
 Ai 14-3016-40 40mm Ø (36 oz)



Ai 14-3017-26
 26.5 cm/10 1/2"
 530 g (19 oz)



Ai 14-3018-24
 24 cm/9 1/2"
 (30mm Ø 480 g)



Ai 14-3019-22
 22.5 cm/9"
 (37mm Ø 370 g)

Ai 14-3025-00
 Spare Faces



Ai 14-3020-24
 24 cm/9 1/2"



Ai 14-3021-26 26.5 cm/10 1/2"
30mm Ø, 510 g (18 oz)



Ai 14-3022-26
26.5 cm/10 1/2"



Ai 14-3023-25 250 g (0.55 lbs)
Ai 14-3023-45 450 g (1 lbs)
Ai 14-3023-90 900 g (2 lbs)
26.5 cm/10 1/2"





Partsch
 mm
 02 Ai 14-3024-02
 03 Ai 14-3024-03
 04 Ai 14-3024-04
 05 Ai 14-3024-05
 06 Ai 14-3024-06
 07 Ai 14-3024-07
 08 Ai 14-3024-08
 13.5 cm/5¼"



Partsch
 Ai 14-3025-02
 Ai 14-3025-03
 Ai 14-3025-04
 Ai 14-3025-05
 Ai 14-3025-06
 Ai 14-3025-07
 Ai 14-3025-08
 17 cm/6¾"
 Ai 14-3026-02
 Ai 14-3026-03
 Ai 14-3026-04
 Ai 14-3026-05
 Ai 14-3026-06
 Ai 14-3026-07
 Ai 14-3026-08
 13.5 cm/5¼"
 Ai 14-3027-02
 Ai 14-3027-03
 Ai 14-3027-04
 Ai 14-3027-05
 Ai 14-3027-06
 Ai 14-3027-07
 Ai 14-3027-08
 17cm/6¾"



Width

mm
 04 Ai 14-3028-04 Ai 14-3029-04 Ai 14-3030-04
 06 Ai 14-3028-06 Ai 14-3029-06 Ai 14-3030-06
 08 Ai 14-3028-08 Ai 14-3029-08 Ai 14-3030-08
 10 Ai 14-3028-10 Ai 14-3029-10 Ai 14-3030-10
 12 Ai 14-3028-12 Ai 14-3029-12 Ai 14-3030-12
 14 Ai 14-3028-14 Ai 14-3029-14 Ai 14-3030-14
 16 Ai 14-3028-16 Ai 14-3029-16 Ai 14-3030-16
 13.5 cm/5¼"



Mod. USA
 mm
 06 Ai 14-3031-06
 12 Ai 14-3031-12
 18 Ai 14-3031-18



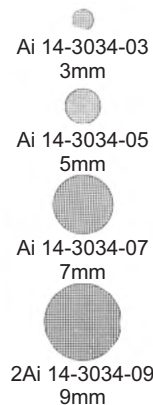
Mod. USA
 Ai 14-3032-06
 Ai 14-3032-12
 Ai 14-3032-18
 16 cm/6¼"



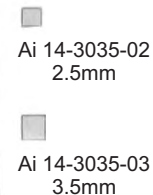
Ai 14-3033-06
 Ai 14-3033-12
 Ai 14-3033-18



16 cm/6¼"

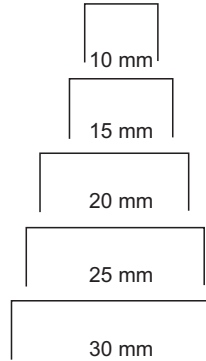


Passow
 12 cm/4¾"

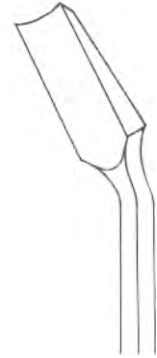




Lexer
 27.5 cm/10¾"



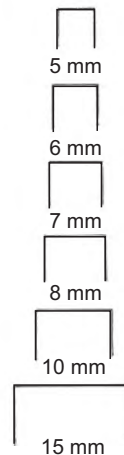
Ai 14-3036-10
 Ai 14-3036-15
 Ai 14-3036-20
 Ai 14-3036-25
 Ai 14-3036-30



Ai 14-3037-10
 Ai 14-3037-15
 Ai 14-3037-20
 Ai 14-3037-25
 Ai 14-3037-30



Cloward
 24 cm/9½"



Ai 14-3038-05
 Ai 14-3038-06
 Ai 14-3038-07
 Ai 14-3038-08
 Ai 14-3038-10
 Ai 14-3038-15



Ai 14-3039-05
 Ai 14-3039-06
 Ai 14-3039-07
 Ai 14-3039-08
 Ai 14-3039-10
 Ai 14-3039-15





Ai 14-3040-10

BUCK-GRAMCKO
 11 cm/4 1/2"



Ai 14-3041-10



Ai 14-3042-10

BUCK-GRAMCKO
 10 cm/4"



Ai 14-3043-10



BUCKLEY
 16 cm/6 1/2"



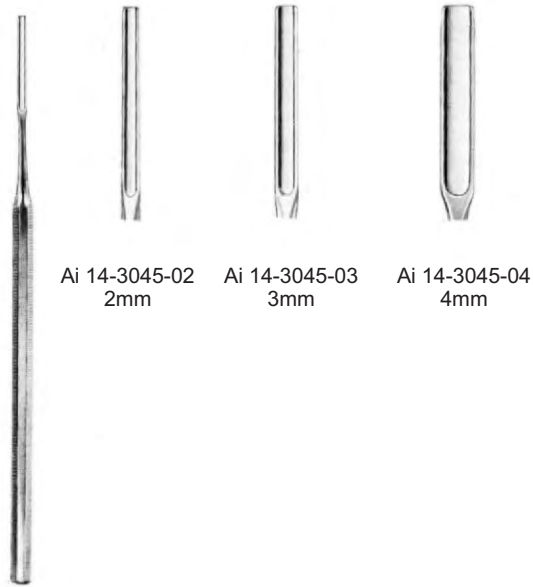
Ai 14-3044-02
 2mm



Ai 14-3044-03
 3mm



Ai 14-3044-04
 4mm



Ai 14-3045-02
2mm

Ai 14-3045-03
3mm

Ai 14-3045-04
4mm

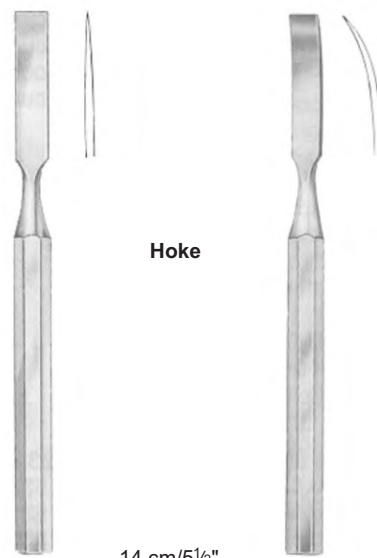
BUCKLEY
16 cm/6 1/2"





Alexander
18 cm/7"

	mm	
Ai 14-3046-04	04	Ai 14-3047-04
Ai 14-3046-06	06	Ai 14-3047-06
Ai 14-3046-08	08	Ai 14-3047-08
Ai 14-3046-10	10	Ai 14-3047-10
Ai 14-3046-12	12	Ai 14-3047-12
Ai 14-3046-14	14	Ai 14-3047-14



Hoke

14 cm/5½"

	mm	
Ai 14-3048-02	2	Ai 14-3049-02
Ai 14-3048-03	3	Ai 14-3049-03
Ai 14-3048-04	4	Ai 14-3049-04
Ai 14-3048-05	5	Ai 14-3049-05
Ai 14-3048-06	6	Ai 14-3049-06
Ai 14-3048-07	7	Ai 14-3049-07
Ai 14-3048-08	8	Ai 14-3049-08



Smith-Petersen
20 cm/8"



mm				
06	Ai 14-3050-06	Ai 14-3051-06	Ai 14-3052-06	Ai 14-3053-06
09	Ai 14-3050-09	Ai 14-3051-09	Ai 14-3052-09	Ai 14-3053-09
13	Ai 14-3050-13	Ai 14-3051-13		
14			Ai 14-3052-14	Ai 14-3053-14
16	Ai 14-3050-16	Ai 14-3051-16	Ai 14-3052-16	Ai 14-3053-16
19	Ai 14-3050-19	Ai 14-3051-19	Ai 14-3052-19	Ai 14-3053-19
25	Ai 14-3050-25	Ai 14-3051-25	Ai 14-3052-25	Ai 14-3053-25
32	Ai 14-3050-32	Ai 14-3051-32	Ai 14-3052-32	Ai 14-3053-32



Lambotte

	mm	
Ai 14-3054-04	04	Ai 14-3055-04
Ai 14-3054-06	06	Ai 14-3055-06
Ai 14-3054-08	08	Ai 14-3055-08
Ai 14-3054-10	10	Ai 14-3055-10
Ai 14-3054-13	13	Ai 14-3055-13
Ai 14-3054-16	16	Ai 14-3055-16
Ai 14-3054-18	18	Ai 14-3055-18
Ai 14-3054-20	20	Ai 14-3055-20
Ai 14-3054-25	25	Ai 14-3055-25
Ai 14-3054-30	30	Ai 14-3055-30
Ai 14-3054-38	38	Ai 14-3055-38
Ai 14-3054-44	44	Ai 14-3055-44
Ai 14-3054-50	50	Ai 14-3055-50

24 cm/9½" 23 cm/9"

Curved



Mini-Lambotte

	mm	
Ai 14-3056-02	02	Ai 14-3057-02
Ai 14-3056-03	03	Ai 14-3057-03
Ai 14-3056-04	04	Ai 14-3057-04
Ai 14-3056-06	06	Ai 14-3057-06
Ai 14-3056-08	08	Ai 14-3057-08
Ai 14-3056-10	10	Ai 14-3057-10
Ai 14-3056-12	12	Ai 14-3057-12
Ai 14-3056-15	15	Ai 14-3057-15
	12.5 cm/5"	17 cm/6¾"



Mini-Lexer

	mm	
Ai 14-3058-04	04	Ai 14-3059-04
Ai 14-3058-06	06	Ai 14-3059-06
Ai 14-3058-08	08	Ai 14-3059-08
Ai 14-3058-10	10	Ai 14-3059-10
Ai 14-3058-12	12	Ai 14-3059-12

18 cm/7"



Str	Lexer mm	Cvd
Ai 14-3060-05	05	Ai 14-3061-05
Ai 14-3060-07	07	Ai 14-3061-07
Ai 14-3060-10	10	Ai 14-3061-10
Ai 14-3060-15	15	Ai 14-3061-15
Ai 14-3060-20	20	Ai 14-3061-20
Ai 14-3060-25	25	Ai 14-3061-25
Ai 14-3060-30	30	Ai 14-3061-30

22 cm/8¾"





Chisel
 Ai 14-3062-20
 24.5 cm/9¾"
 20 mm



Chisel-Curved
 Ai 14-3063-20
 26.5 cm/10½"
 20 mm

Gouge for the
 removing of
 broken screws



Ai 14-3064-22
 22 cm/8¾"

Zielke
 23 cm/9"
 5.5 mm
 9.0 mm



Ai 14-3065-05
 Ai 14-3065-09

Width



mm

Stille
 20 cm/8"

06	Ai 14-3066-06	Ai 14-3067-06	Ai 14-3068-06	Ai 14-3069-06	Ai 14-3070-06
08	Ai 14-3066-08	Ai 14-3067-08	Ai 14-3068-08	Ai 14-3069-08	Ai 14-3070-08
10	Ai 14-3066-10	Ai 14-3067-10	Ai 14-3068-10	Ai 14-3069-10	Ai 14-3070-10
12	Ai 14-3066-12	Ai 14-3067-12	Ai 14-3068-12	Ai 14-3069-12	Ai 14-3070-12
15	Ai 14-3066-15	Ai 14-3067-15	Ai 14-3068-15	Ai 14-3069-15	Ai 14-3070-15
20	Ai 14-3066-20	Ai 14-3067-20	Ai 14-3068-20	Ai 14-3069-20	Ai 14-3070-20
25	Ai 14-3066-25	Ai 14-3067-25	Ai 14-3068-25	Ai 14-3069-25	Ai 14-3070-25
30	Ai 14-3066-30	Ai 14-3067-30	Ai 14-3068-30	Ai 14-3069-30	Ai 14-3070-30

Hibbs
 24 cm/9 1/2"

mm

06	Ai 14-3071-06	Ai 14-3072-06	Ai 14-3073-06	Ai 14-3074-06	Ai 14-3075-06
09	Ai 14-3071-09	Ai 14-3072-09	Ai 14-3073-09	Ai 14-3074-09	Ai 14-3075-09
13	Ai 14-3071-13	Ai 14-3072-13	Ai 14-3073-13	Ai 14-3074-13	Ai 14-3075-13
16	Ai 14-3071-16	Ai 14-3072-16	Ai 14-3073-16	Ai 14-3074-16	Ai 14-3075-16
19	Ai 14-3071-19	Ai 14-3072-19	Ai 14-3073-19	Ai 14-3074-19	Ai 14-3075-19
25	Ai 14-3071-25	Ai 14-3072-25	Ai 14-3073-25	Ai 14-3074-25	Ai 14-3075-25
32	Ai 14-3071-32	Ai 14-3072-32	Ai 14-3073-32	Ai 14-3074-32	Ai 14-3075-32





Lexer
 mm 05 Ai 14-3076-05
 10 Ai 14-3076-10
 15 Ai 14-3076-15
 28 cm/11"



Lexer
 Ai 14-3077-05
 Ai 14-3077-10
 Ai 14-3077-15
 25 cm/10"



Lexer
 Ai 14-3078-05
 Ai 14-3078-10
 Ai 14-3078-15
 25 cm/10"



Ai 14-3079-01



Ai 14-3079-02



Ai 14-3079-03



Cobb
 28 cm/11" Ai 14-3079-04



Putti
Ai 14-3080-30
30 cm/12"



Putti
Ai 14-3081-27
27 cm/10½"



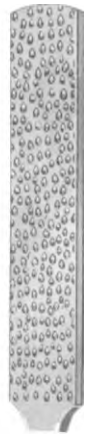
Ai 14-3082-28
28 cm/11"



Ai 14-3083-24
24 cm/9½"



Ai 14-3084-22
22 cm/8¾"





Miller
10
Ai 14-3085-10



Miller
11
Ai 14-3086-11



Miller
12
Ai 14-3087-12



Miller
13
Ai 14-3088-13



Miller
14
Ai 14-3089-14



Miller
10c
Ai 14-3090-10



Miller
11c
Ai 14-3091-11



Miller
12c
Ai 14-3092-12



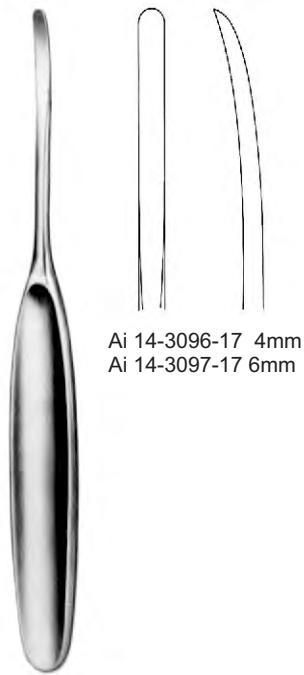
Miller
13c
Ai 14-3093-13



Fomon
21.5cm
Ai 14-3094-21

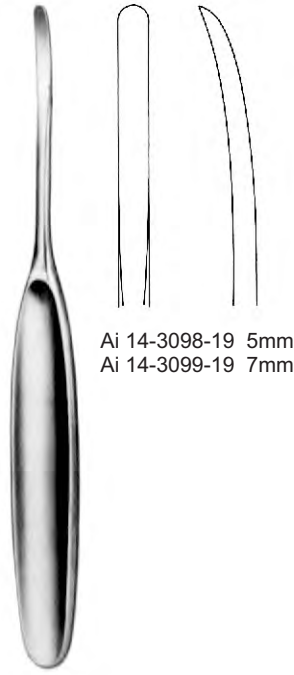


Fomon
21.5cm
Ai 14-3095-21



Ai 14-3096-17 4mm
 Ai 14-3097-17 6mm

CUSHING
 17 cm/8 1/2"



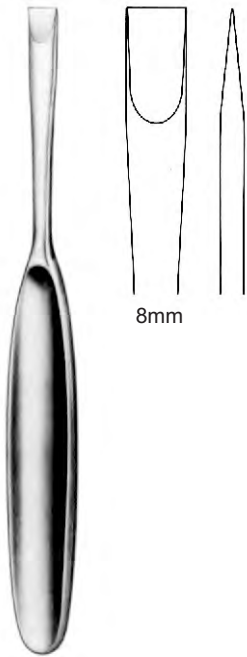
Ai 14-3098-19 5mm
 Ai 14-3099-19 7mm

CUSHING
 19.5 cm/7 3/4"



Ai 14-3100-16 7mm, 16 cm/6 1/2"
 Ai 14-3100-18 15mm, 18.5 cm/7 1/2"
 Ai 14-3100-19 20mm, 19 cm/7 3/4"

HOEN

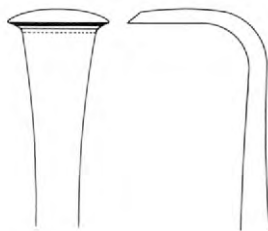


8mm

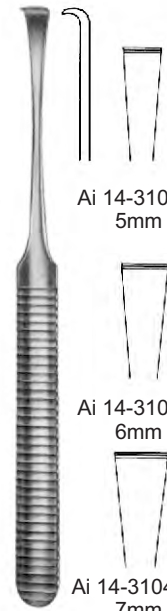
CUSHING
 Ai 14-3101-17
 17 cm/6 3/4"



LANGENBECK
 Ai 14-3102-18
 18 cm/7"



LANGENBECK
 Ai 14-3103-19
 19 cm/7 3/4"



Ai 14-3104-5
 5mm

Ai 14-3104-6
 6mm

Ai 14-3104-33
 7mm

16 cm/6 1/2"

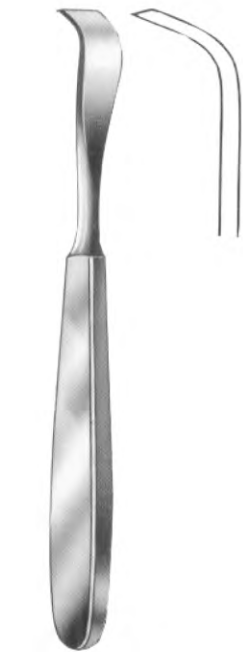




Lambotte
21 cm/8¼"

Width

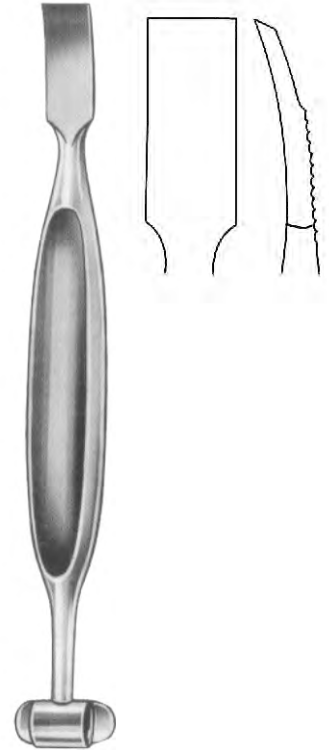
- Ai 14-3105-21 05 mm
- Ai 14-3106-21 10
- Ai 14-3107-21 15
- Ai 14-3108-21 20
- Ai 14-3109-21 25



Schneider
Ai 14-3110-17
13 mm
17.5 cm/7"



Schneider-Sauerbruch
Ai 14-3111-19
13 mm
19 cm/7½"



Alexander
Ai 14-3112-20
20 cm/8"



Jansen
Ai 14-3113-16
15 mm
16.5 cm/6½"



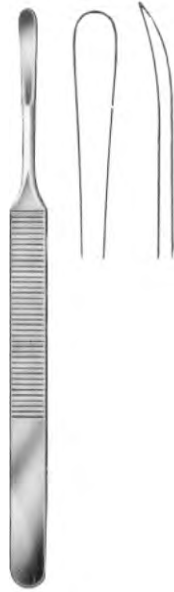
Seldin
Ai 14-3114-19
19 cm/7½"



Davidson-Alexander
Ai 14-3115-29
29 cm/11½"



Williger
Ai 14-3116-13
13 cm/5"



Konig
 Ai 14-3117-15
 15.5 cm/6"
 5 mm



Williger
 Ai 14-3118-16
 16 cm/6¼"



Adson
 17 cm/6¾"



Ai 14-3119-17



Ai 14-3120-17



Ai 14-3121-17



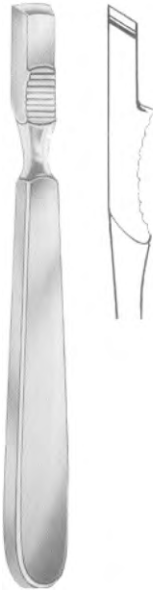
Ai 14-3122-17



Ai 14-3123-17 17 cm/6¾"
 6 mm

Ai 14-3124-17
 8 mm





Farabeuf
 Ai 14-3125-15
 15 cm/6"



Farabeuf
 Ai 14-3126-15
 15 cm/6"



Farabeuf-Collin
 Ai 14-3127-15
 15.5 cm/6"
 11 mm



Farabeuf-Collin
 Ai 14-3128-15
 15.5 cm/6"
 11 mm



Farabeuf
 Ai 14-3129-19
 19 cm/7 1/2"
 13 mm



Sedillot
 Ai 14-3130-18
 18 cm/7"
 18 mm



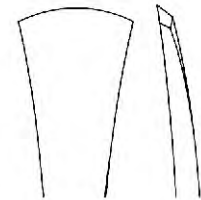
Sedillot
 Ai 14-31301-21
 21 cm/8 1/4"
 15 mm



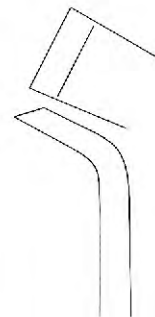
LANGENBECK



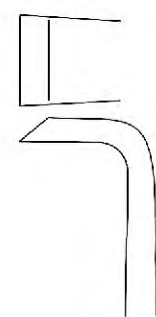
Ai 14-3134-19
 19.0cm, 16mm



Ai 14-3135-19
 19.0cm, 16cm



Ai 14-3132-19
 19.0cm, 12mm



Ai 14-3133-18
 18.0cm, 12mm



Overholt
 Ai 14-3136-29
 29.5 cm/11½"



Overholt
 Ai 14-3137-29
 29.5 cm/11½"



Overholt
 Ai 14-3138-28
 28.5 cm/11¼"



Hyllin
 Ai 14-3141-14
 14.5 cm/5¾"



Ai 14-3139-14



Ai 14-3140-14



Matson
 Ai 14-3142-22
 22 cm/8¾"





Semb

Ai 14-3143-19
 19.5 cm/7½"
 12 mm



Ai 14-3144-19
 19.5 cm/7½"
 12 mm



Ai 14-3145-19
 19.5 cm/7½"
 12 mm



Ai 14-3146-22
 22 cm/8¾"
 13 mm



Ai 14-3147-21
 21.5 cm/8½"
 13 mm



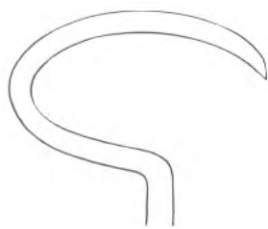
Ai 14-3148-22
 22 cm/8½"
 15 mm



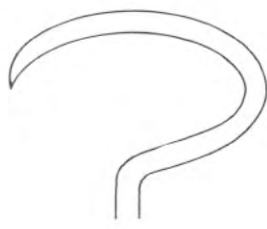
Ai 14-3149-22
 22 cm/8½"
 15 mm



Doyen
 17 cm/6¾"



Ai 14-3150-17



Ai 14-3153-17



Ai 14-3151-17



Ai 14-3152-17



Doyen
 Ai 14-3154-24 24 cm/9½" Ai 14-3155-24





Ai 14-3156-24
4 mm



Ai 14-3157-24
6 mm



Ai 14-3158-24
8 mm



Cobb
24 cm/9½"



Ai 14-3159-24
10 mm



Ai 14-3160-24
13 mm



Ai 14-3161-24
19 mm



Ai 14-3162-24
25 mm





Ai 14-3163-19
19 cm/7½"
6 mm



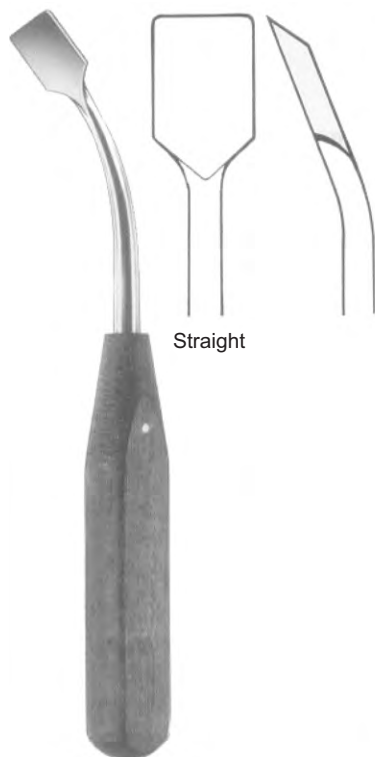
Ai 14-31634-18
18.5 cm/7¼"
3 mm



Ai 14-3165-18
18.5 cm/7¼"
6 mm



Ai 14-3166-18
18.5 cm/7¼"
6 mm



Ai 14-3167-18
18.5 cm/7¼"
13 mm



Ai 14-3168-19
19.5 cm/7¾"
14 mm



Ai 14-3169-18
18.5 cm/7¼"
14 mm



Ai 14-3170-20
20 cm/8"
20 mm



Ai 14-3171-27
 27.5 cm/10¾"
 20 mm



Wagner
 8 mm Ai 14-3172-33
 17 mm Ai 14-3173-33
 33 cm/13"



Cobb
 24 cm 28 cm
 10 mm Ai 14-3174-24 Ai 14-3179-28
 13 mm Ai 14-3175-24 Ai 14-3180-28
 19 mm Ai 14-3176-24 Ai 14-3181-28
 25 mm Ai 14-3177-24 Ai 14-3182-28
 32 mm Ai 14-3178-24 Ai 14-3183-28



Cobb
 08 mm Ai 14-3184-28
 10 mm Ai 14-3185-28
 12 mm Ai 14-3186-28
 28 cm/11"



Cobb
 27.0cm
 Ai 14-3187-27 4mm
 Ai 14-3188-27 6mm
 Ai 14-3189-27 8mm





Ai 14-3190-16
16 cm/6¼"
7 mm

Ai 14-3190-18
18.5 cm/7¼"
15 mm

Ai 14-3190-19
19 cm/7½"
20 mm

Hoen



Yankauer
Ai 14-3191-18
18 cm/7"



Langenbeck
Ai 14-3192-20
20 cm/8"
8 mm



Langenbeck
Ai 14-3193-20
20 cm/8"
10 mm



Langenbeck
Ai 14-3194-23
23 cm/9"
11 mm



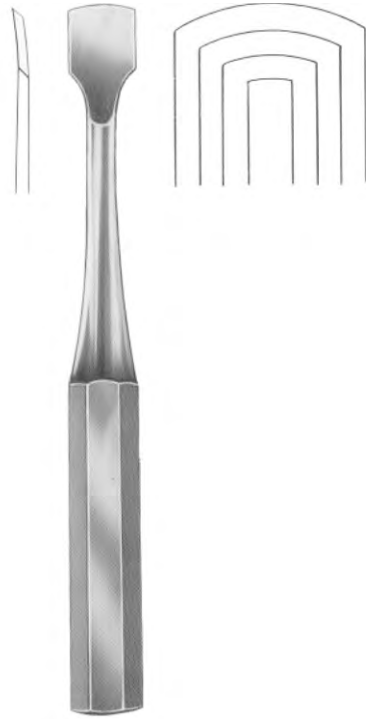
Mass. Gen. Hosp.
Ai 14-3195-15
15 cm/6"



Quervain
Ai 14-3196-20
20 cm/8"



Alderdyce
 Ai 14-3197-16
 16 cm/6 1/4"



Key
 Width Ai 14-3198-19 19 cm/7 1/2"
 6 mm Ai 14-3199-19 19 cm/7 1/2"
 12 mm Ai 14-3200-19 19 cm/7 1/2"
 19 mm Ai 14-3201-19 19 cm/7 1/2"
 25 mm



Konig
 Ai 14-3202-15
 15 cm/6"
 4.5 mm



Konig
 Ai 14-3203-15
 15 cm/6"
 4.5 mm



Alderdyce
 Ai 14-3204-21
 21 cm/8 1/4"

McDonald
 Ai 14-3205-19
 19 cm/7 1/2"

Watson-Cheyne
 Ai 14-3206-17
 17.5 cm/7"



Sebilleau
 Ai 14-3207-17
 17 cm/6 3/4"

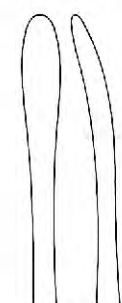




LANGENBECK
20 cm/8"
Ai 14-3208-20 8mm
Ai 14-3209-20 10mm



LANGENBECK



Ai 14-3210-17
17 cm/6 1/2"
5mm



Ai 14-3211-17
17 cm/6 1/2"
7mm



Ai 14-3212-20
20 cm/8"
8mm



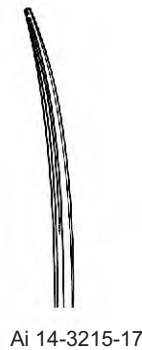
Ai 14-3213-20
20 cm/8"
10mm



ST. THOMAS
Ai 14-3214-18
18 cm/7"



WILLIGER
17 cm/6 3/4"



Ai 14-3215-17



WILLIGER
16 cm/6 1/2"



Ai 14-3216-16



LANE
Ai 14-3217-26
26.5 cm/10 1/2"



LANE TRETOWAN
Ai 14-3218-21
21.5 cm/8 1/2"



LANE
Ai 14-3219-25
25.5 cm/10"

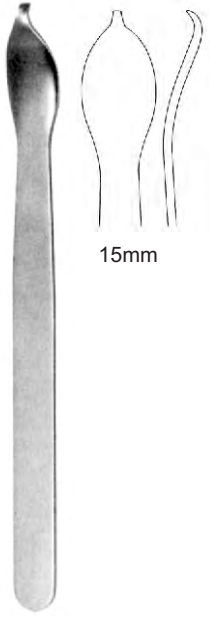


BRISTOW
Ai 14-3220-23
23 cm/9"



MURPHY-LANE
Ai 14-3221-34
34 cm/11 1/2"





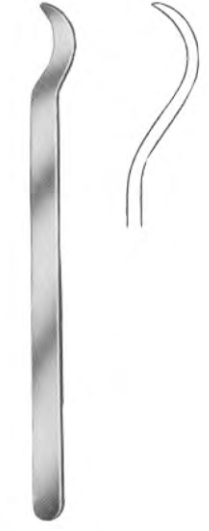
Ai 14-3222-16
 16 cm/6 1/2"



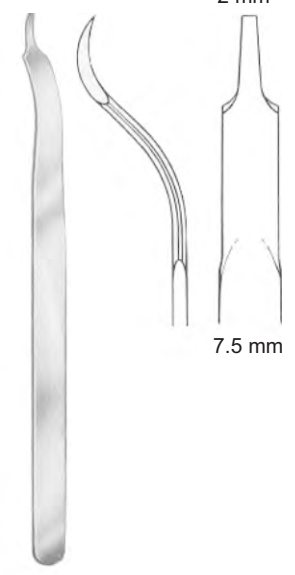
Ai 14-3223-14
 14 cm/5 1/2"
 2.8 mm



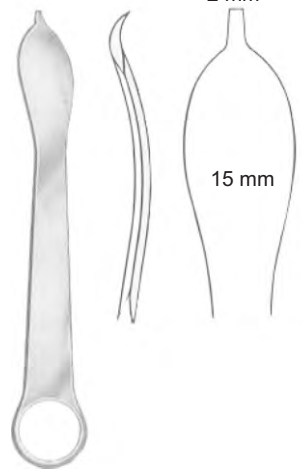
Ai 14-3224-14
 14 cm/5 1/2"
 5 mm



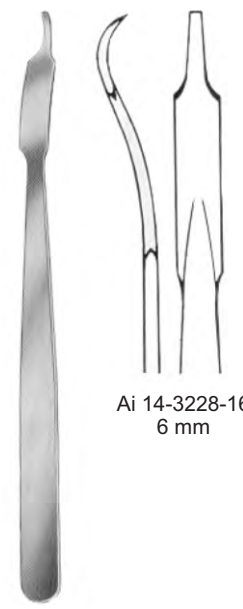
Ai 14-3225-14
 14 cm/5 1/2"
 7 mm



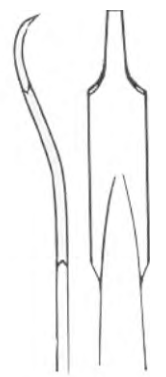
Buck-Gramcko
 Ai 14-3226-15
 15 cm/6"



Ai 14-3227-12
 12.5 cm/5"



Mini-Hohmann
 Ai 14-3228-16
 16 cm/6 1/4"



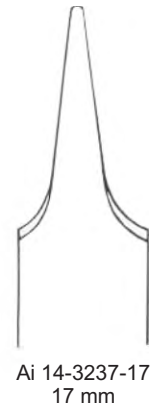
Ai 14-3229-16
 8 mm



Ai 14-3230-16
 16 cm/6 1/2"



Ai 14-3231-17
 17.5 cm/7"



Ai 14-3232-26
26.5 cm/10½"
24 mm



Lange-Hohmann
 Ai 14-3233-26
 26 cm/10¼"
 22 mm



Hohmann
 Ai 14-3234-22
 22 cm/8¾"
 8 mm



Hohmann
 Ai 14-3235-24
 24 cm/9½"
 14 mm





Hohmann
 Ai 14-3238-26
 26 cm/10 1/4"
 22 mm

Hohmann
 Ai 14-3239-28
 28 cm/11"
 33 mm

Hohmann
 Ai 14-3240-24
 24 cm/9 1/2"
 43 mm

Hohmann
 Ai 14-3241-24
 24.5 cm/9 3/4"
 43 mm

Hohmann
 Ai 14-3242-24
 24 cm/9 1/2"
 70 mm

Hohmann
 Ai 14-3243-22
 22 cm/8 3/4"
 18 mm



Lange-Hohmann modif
 30 mm Ai 14-3244-26 26.5 cm/10 1/2"
 33 mm Ai 14-3244-29 29.0 cm/11 1/2"



Hohmann-Aldinger
 Ai 14-3245-27
 27 cm/10 1/2"



Schumacher
 (Wagner)
 Ai 14-3246-34
 34.5 cm/13 1/2"



Schumacher
 Ai 14-3247-29
 29 cm/11 1/2"





Smillie
14 cm/5½"

- Ai 14-3248-14
32 x19 mm
- Ai 14-3249-14
48 x19 mm
- Ai 14-3250-14
57 x19 mm



Ai 14-3251-14
52 x13 mm



Ai 14-3252-14
12 x13 mm

Spinal retractors



- Ai 14-3253-17
75x30 mm
- Ai 14-3254-17
100x30 mm

Taylor
17 cm/6½"



Ai 14-3255-21
21.5 cm/8½"

Meniscus retractors



Blount
Ai 14-3256-17
17.5 cm/7"



Murphy-Lane
 Ai 14-3257-32 18 cm
 32 cm/12½"



Chandler

Length	Width	
13 mm	13 mm	Ai 14-3258-18
19 mm	19 mm	Ai 14-3258-20
25 mm	25 mm	Ai 14-3258-23
30 mm	30 mm	Ai 14-3258-25



Lange-Hohmann
 Ai 14-3259-27 27 cm/10 ½"
 Ai 14-3260-29 29 cm/11 ½"



Bennett
 Ai 14-3261-24 24 cm/8 ½"
 Ai 14-3262-26 26 cm/10 ½"



Blount
 Ai 14-3263-26 26 cm/10¼"



Blount
 Ai 14-3264-26 26 cm/10¼"



Ai 14-3265-24 44 mm
 Ai 14-3266-24 64 mm
Bennett Retractor
 24 cm/9½"



Ai 14-3267-17 17 cm/6 ¾", 56x10mm
Bennett Retractor





Smillie
 Ai 14-3268-17
 17 cm/6¾"



Smillie
 Ai 14-3269-17
 17 cm/6¾"



Smillie
 Ai 14-3270-17
 17 cm/6¾"



Salenius
 Ai 14-3271-22
 22 cm/8¾"



Salenius
 Ai 14-3272-22
 22 cm/8¾"



Mod. Schweden
 17 cm/6¾"



left cutting
 Ai 14-3273-17

right cutting
 Ai 14-3274-17



Lowe-Breck
 Ai 14-3275-25
 25 cm/10"



Downing
 Ai 14-3276-25
 25 cm/10"



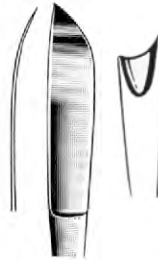
Neff
 Ai 14-3277-17
 17.5 cm/7"



Neff
 21.5 cm/8½"



Ai 14-3278-21
 Left



Ai 14-3279-21
 Right



Canad-Modell
 Ai 14-3280-20 20 cm/8"



Ai 14-3281-20



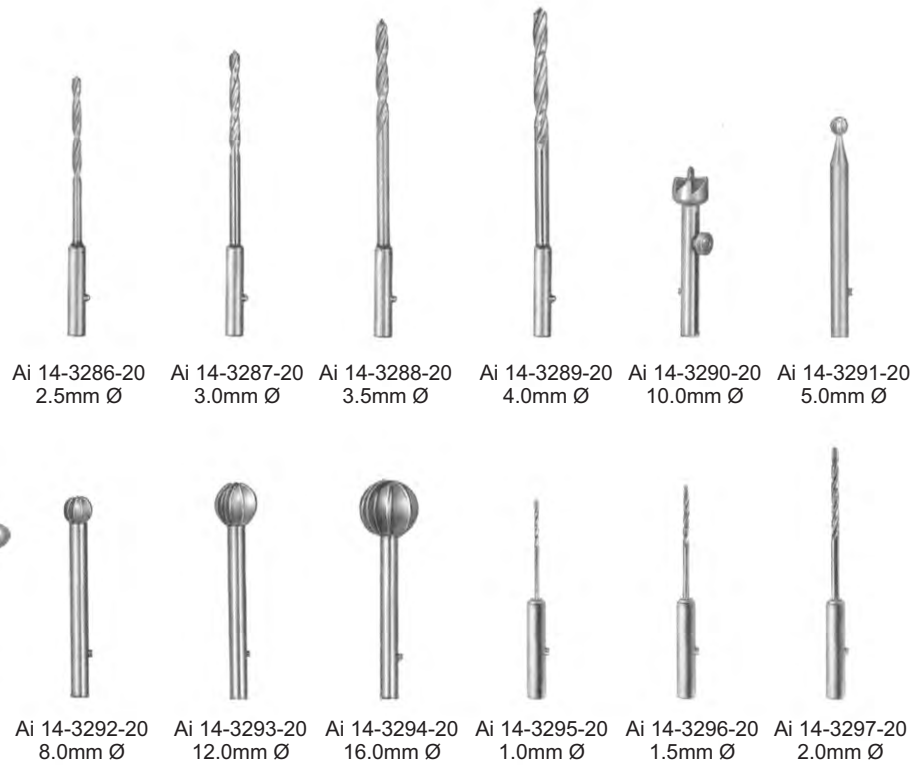
BIRCHER
 19 cm/7¾"



Ai 14-3282-19
 Ai 14-3283-19



Stille
 20 cm/8"
 Ai 14-3284-20 compl. set
 Ai 14-3285-20 drill only



Ai 14-3286-20 2.5mm Ø	Ai 14-3287-20 3.0mm Ø	Ai 14-3288-20 3.5mm Ø	Ai 14-3289-20 4.0mm Ø	Ai 14-3290-20 10.0mm Ø	Ai 14-3291-20 5.0mm Ø
Ai 14-3292-20 8.0mm Ø	Ai 14-3293-20 12.0mm Ø	Ai 14-3294-20 16.0mm Ø	Ai 14-3295-20 1.0mm Ø	Ai 14-3296-20 1.5mm Ø	Ai 14-3297-20 2.0mm Ø





Ai 14-3298-00 compl. set
 Ai 14-3299-00 drill only

Ai 14-3300-09 9.0cm 3.2mm Ø
 Ai 14-3300-07 7.0cm 3.2mm Ø
 Ai 14-3199-08 Set of drills



Jacobs
 Ai 14-3301-06 6.35mm



Ai 14-3302-00 set



Ai 14-3303-00 set



Stille-Sherman
 24 cm/9 3/4"
 Ai 14-3304-24 compl. set
 Ai 14-3305-24 drill only



Ai 14-3306-24 2.5mm Ø Ai 14-3307-24 3.0mm Ø Ai 14-3308-24 3.5mm Ø



Hudson
 Ai 14-3309-00 compl. set / 6
 (Ai 14-3311-00,01,02,03,07,09)
 Ai 14-3310-00 handle only



Ai 14-3312-09 9mm Ø



Ai 14-3313-14 14mm Ø



Ai 14-3314-16 16mm Ø



Ai 14-3315-22 22mm Ø



Cushing
 Ai 14-3316-14 14mm Ø



Ai 14-3317-02 2mm Ø



Mckenzie
 Ai 14-3318-13 13mm Ø

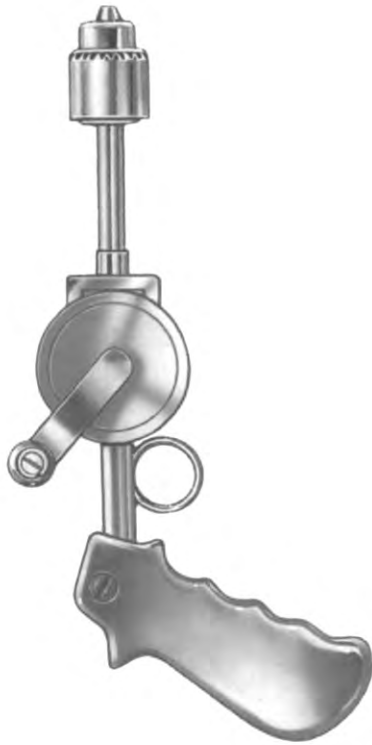


Errico
 Ai 14-3319-16 16mm Ø



Ai 14-3320-00





Ai 14-3321-00



Ai 14-3322-00



Ai 14-3323-00



Ai 14-3324-00 complete set



Ai 14-3325-00



Kirschner
Ai 14-3326-00 complete set



Ai 14-3328-00



Ai 14-3329-00



Ai 14-3327-00

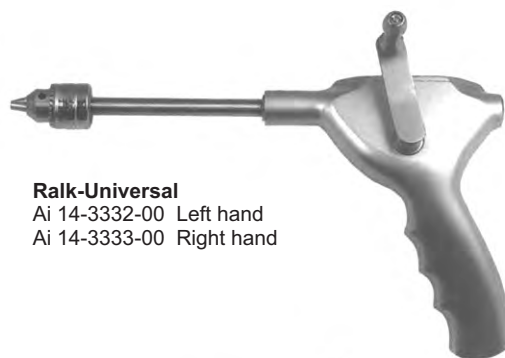




Bunnell
Ai 14-3330-00



Ralk
Ai 14-3331-00



Ralk-Universal
Ai 14-3332-00 Left hand
Ai 14-3333-00 Right hand



Ai 14-3334-00



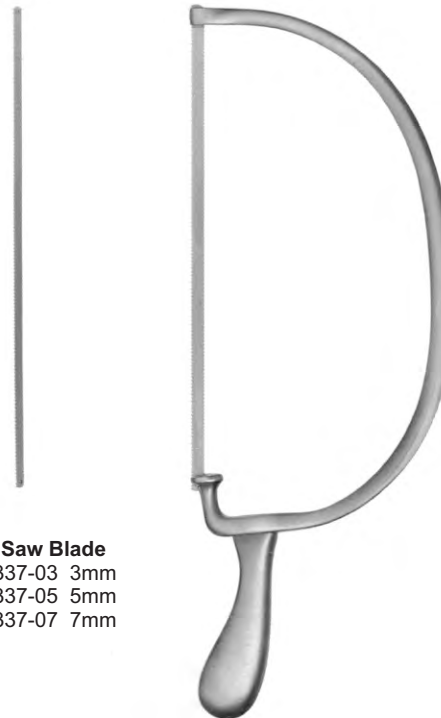


Spare Saw Blade
 Ai 14-3335-12 12mm
 Ai 14-3335-15 15mm
 Ai 14-3335-18 18mm



Charriere
 Ai 14-3336-35
 35 cm/14"

Spare Saw Blade
 Ai 14-3337-03 3mm
 Ai 14-3337-05 5mm
 Ai 14-3337-07 7mm



Helferich-Bier
 Ai 14-3338-39
 39 cm/15 3/4"

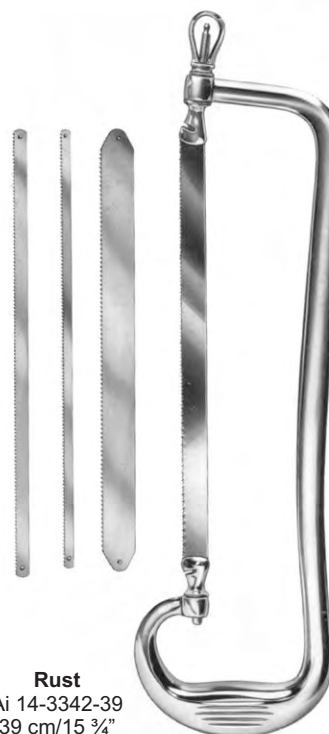


Lindemann
 Ai 14-3339-20
 20 cm/8"



Langenbeck
 Ai 14-3340-23
 23 cm/9"

Ai 14-3341-06 6mm
 Ai 14-3341-08 8mm
 Ai 14-3341-12 12mm
 Ai 14-3341-15 15mm
 Ai 14-3341-18 18mm



Rust
 Ai 14-3342-39
 39 cm/15 3/4"



Charriere
 Ai 14-3343-27 27 cm/11"
 Ai 14-3343-30 30 cm/12"
 Ai 14-3343-34 33 cm/13"



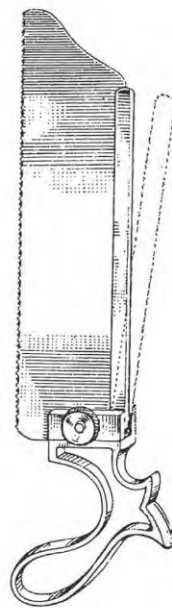
Satterlee
 Ai 14-3344-31
 31 cm/12 1/2"



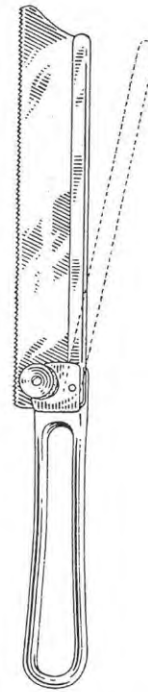
Charriere
 Ai 14-3345-27 27 cm/11"
 Ai 14-3345-30 30 cm/12"



Satterlee
 Ai 14-3346-31
 31 cm/12 1/2"

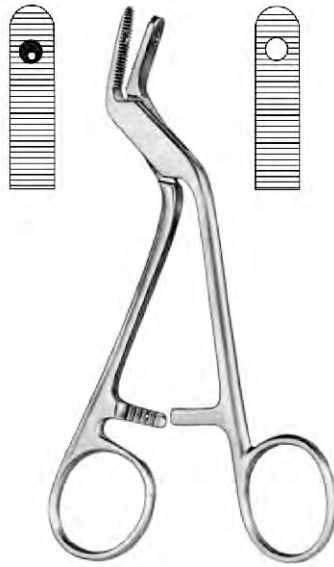


Ai 14-3347-23
 23 cm/9"



Ai 14-3348-19
 19 cm/7 1/2"





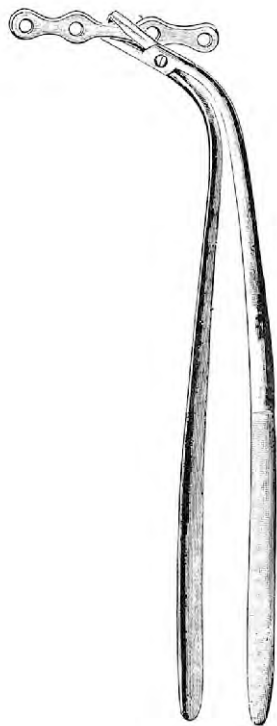
ADSON
 Ai 14-3349-15
 15 cm/6"



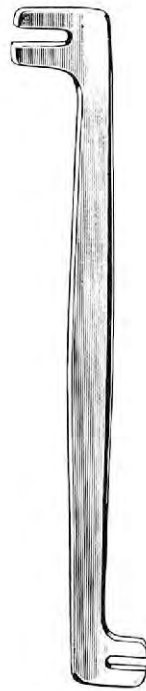
LANE
 Ai 14-3350-18
 18 cm/7"



LANE
 Ai 14-3351-23
 23 cm/9"



LANE
 Ai 14-3352-23
 23 cm/9"



LANE
 Ai 14-3353-18
 18 cm/7"



Ai 14-3354-25
 25.5 cm/10"



Ai 14-3355-25
 25 cm/10"



PHILLIPS
 Ai 14-3356-25
 25 cm/10"



LANE
 Ai 14-3357-17 17 cm/6 3/4"
 Ai 14-3358-25 25 cm/10"



WILLIAMS
 Ai 14-3359-24 Flat
 Ai 14-3360-24 Cross Slot
 24 cm/9 1/2"





HEXAGONAL
 Ai 14-3361-25 2.5mm
 Ai 14-3362-25 3.5mm
 Ai 14-3363-25 4.5mm
 25 cm/10"



PHILLIPS
 Ai 14-3364-25
 25 cm/10"



Ai 14-3365-25
 25 cm/10"



LANE
 Ai 14-3366-17 17 cm/6 1/2"
 Ai 14-3367-25 25 cm/10"



1/2
 Ai 14-3368-14
 14.5 cm/5 1/2"



1/4
 Ai 14-3369-00



Ai 14-3370-00 Screw driver set, complete in case
 Ai 14-3370-00 Sterilizing case only



1/4
 Ai 14-3372-00



1/4
 Ai 14-3373-00



1/4
 Ai 14-3374-00



1/4
 Ai 14-3375-00



2.5mm 3.5mm
 Ai 14-3376-00
 Ai 14-3377-00





Ai 14-3378-2
2.4mm



Ai 14-3379-3
3.2mm



Ai 14-3380-4
4.8mm



Ai 14-3381-6
6.4cm



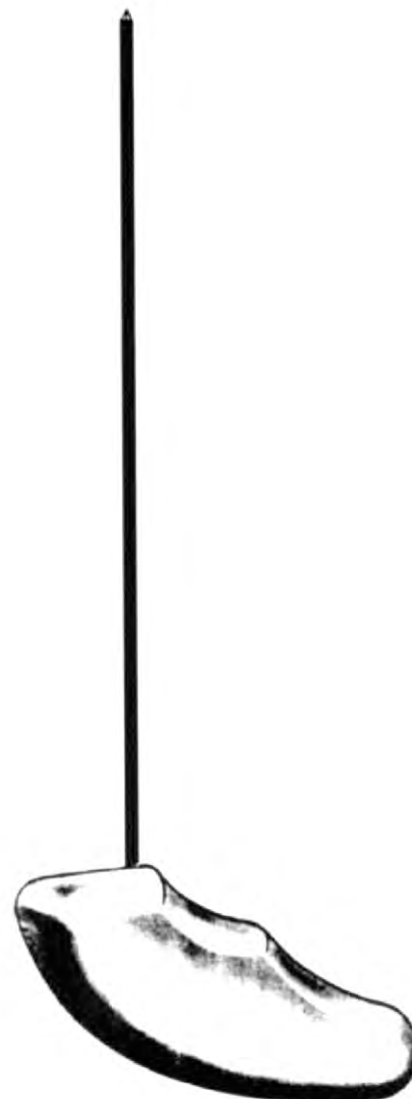
Ai 14-3382-14
14 cm/5 1/2"



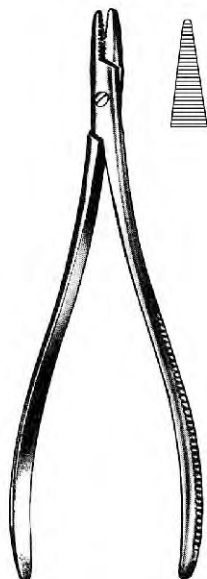
Ai 14-3383-14
14 cm/5 1/2"



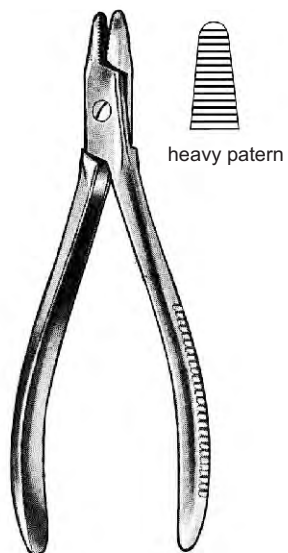
PERTHES
Ai 14-3384-21
21 cm/8 1/2"



TABB
 Ai 14-3385-2 2.4mm
 Ai 14-3385-3 3.2mm
 Ai 14-3385-4 4.8mm
 Ai 14-3385-6 6.4mm



Ai 14-3386-16
 16.5 cm/6 1/2"



Ai 14-3387-16
 16 cm/6 1/2"



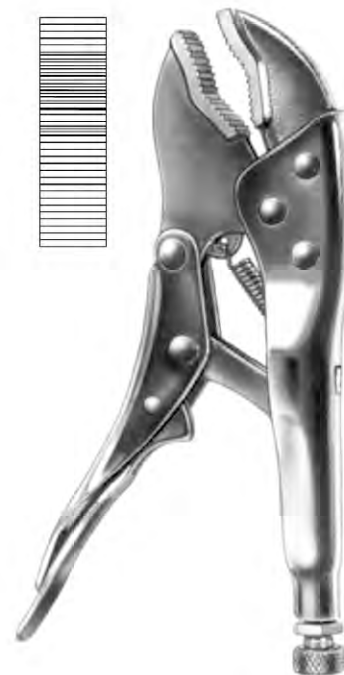
Ai 14-3388-15
 15 cm/6"



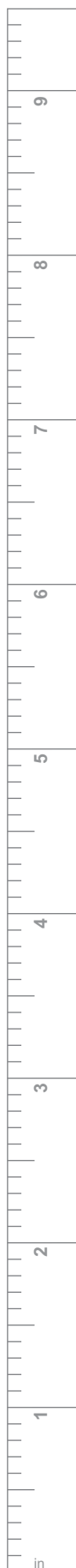
Ai 14-3389-17
 17 cm/6 3/4"



Ai 14-3390-18
 18 cm/7"



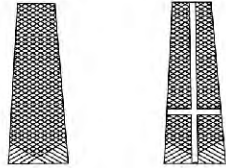
Ai 14-3391-18
 18 cm/7"





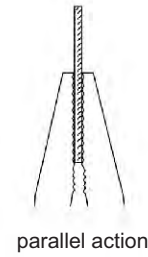
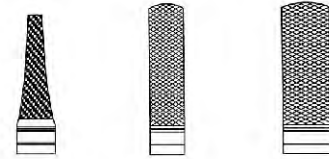
17 cm/6 3/4"

Ai 14-3392-17 Ai 14-3393-17



18 cm/7"

Ai 14-3394-18 Ai 14-3395-18 Ai 14-3396-18

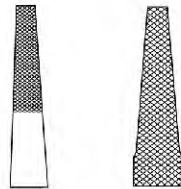


parallel action



14 cm/5 1/2"

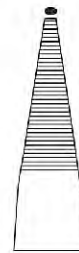
Ai 14-3397-14 Ai 14-3398-14



Ai 14-3399-16
16 cm/6 1/4"



Ai 14-3400-19
19.5 cm/7 3/4"





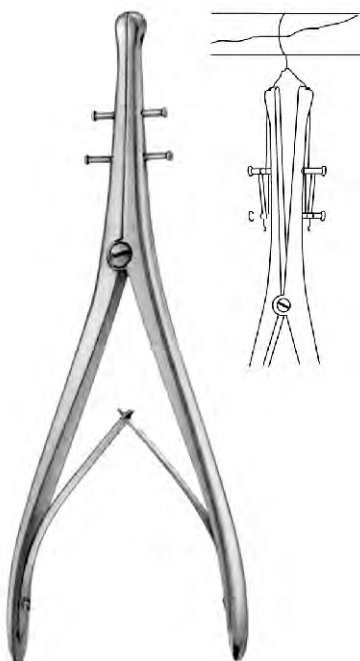
PARHAM

Ai 14-3401-18 18 cm/7"
 Ai 14-3401-20 20 cm/8"
 Ai 14-3401-25 25 cm/10"
 Ai 14-3401-30 30 cm/12"



PARHAM

Ai 14-3402-22
 22 cm/9 3/4"



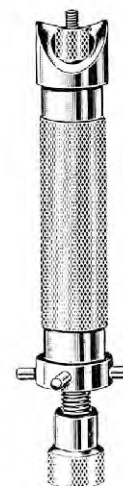
DEMEL

Ai 14-3403-28
 28 cm/11"



LOUTE

Ai 14-3404-21
 21 cm/8 1/4"



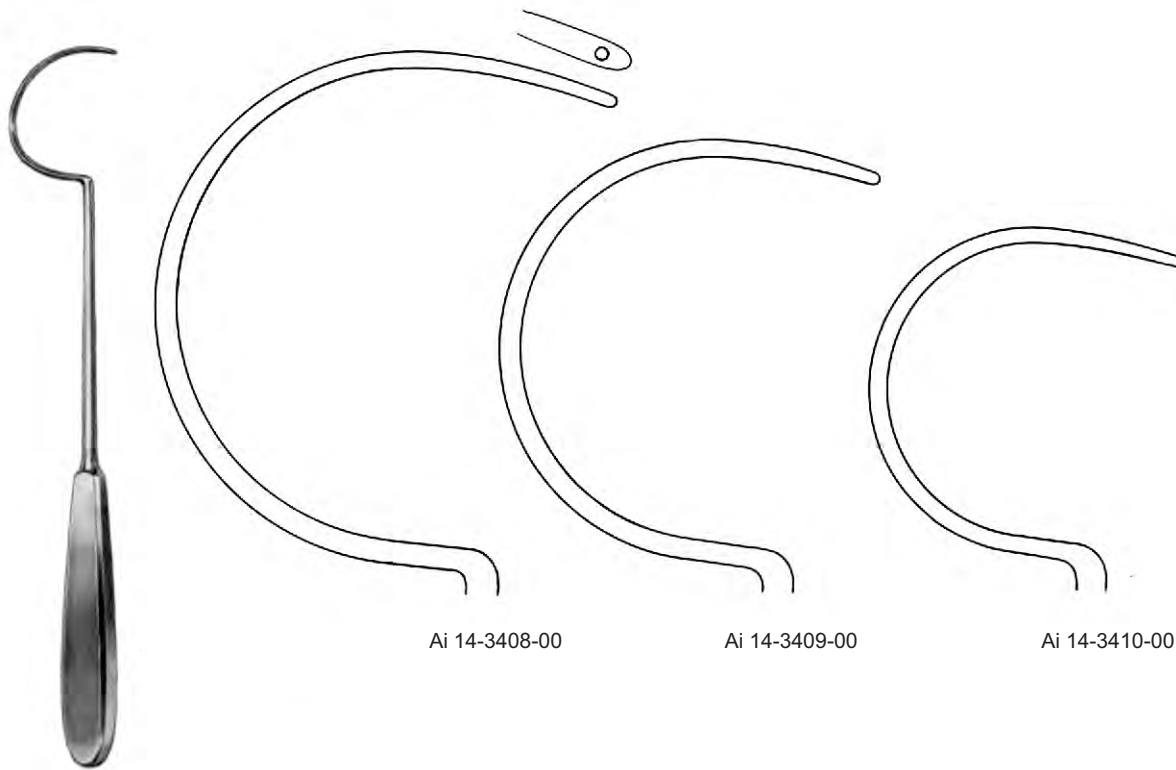
LLOYD

Ai 14-3405-00





	soft	hard
0.2mm Ø	Ai 14-3406-02	
0.3mm Ø	Ai 14-3406-03	Ai 14-3407-03
0.4mm Ø	Ai 14-3406-04	Ai 14-3407-04
0.5mm Ø	Ai 14-3406-05	
0.6mm Ø	Ai 14-3406-06	Ai 14-3407-06
0.7mm Ø	Ai 14-3406-07	
0.8mm Ø	Ai 14-3406-08	Ai 14-3407-08
0.9mm Ø	Ai 14-3406-09	
1.0mm Ø	Ai 14-3406-10	Ai 14-3407-10
1.2mm Ø	Ai 14-3406-12	
1.5mm Ø	Ai 14-3406-15	



DEMEL

Ai 14-3408-00

Ai 14-3409-00

Ai 14-3410-00



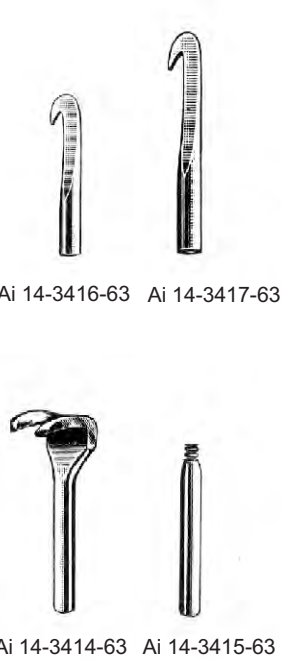
KUENTSCHER
 Ai 14-3411-21
 21 cm/8 1/4"



KUENTSCHER
 Ai 14-3412-21
 21 cm/8 1/4"

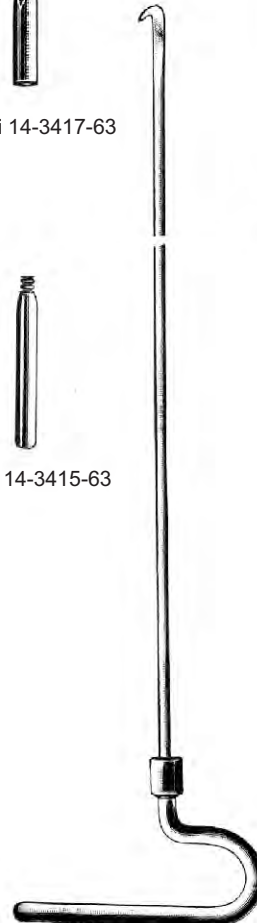


KUENTSCHER
 Ai 14-3413-63
 63 cm/26"
 complete set

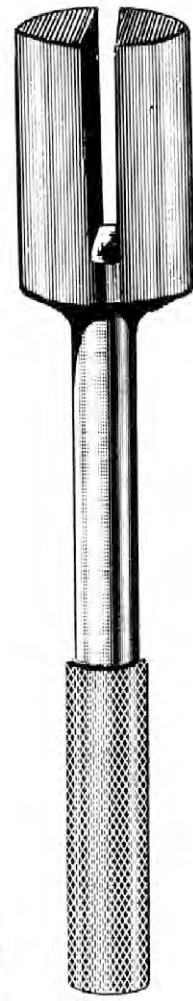


Ai 14-3416-63 Ai 14-3417-63

Ai 14-3414-63 Ai 14-3415-63



Ai 14-3418-29 29 cm/11 3/4"
 Ai 14-3418-37 37 cm/15"
 Ai 14-3418-42 42 cm/16 3/4"
 Ai 14-3418-49 49 cm/19 3/4"



Ai 14-3419-00





	L=35cm	L=46cm	L=60cm
2.5mm Ø	Ai 14-3420-25	Ai 14-3421-25	
3.0mm Ø	Ai 14-3420-30	Ai 14-3421-30	
3.5mm Ø	Ai 14-3420-35	Ai 14-3421-35	Ai 14-3422-35
4.0mm Ø	Ai 14-3420-40	Ai 14-3421-40	Ai 14-3422-40
5.0mm Ø	Ai 14-3420-50	Ai 14-3421-50	Ai 14-3422-50

KUENTSCHER
Ai 14-3423-25
25.5 cm/10"

KUENTSCHER
Ai 14-3424-35
35 cm/14"




STEINMANN
4mm Ø (Trocar tip)
Ai 14-3425-14 140mm
Ai 14-3425-16 160mm
Ai 14-3425-18 180mm
Ai 14-3425-20 200mm

SCHANZ
4mm Ø (Flat tip)
Ai 14-3426-06 60mm
Ai 14-3426-08 80mm
Ai 14-3426-10 100mm

SCHANZ
6mm Ø (Flat tip)
Ai 14-3427-10 100mm
Ai 14-3427-13 130mm
Ai 14-3427-16 160mm
Ai 14-3427-19 190mm


SCHANZ
5mm Ø (Trocar tip)
Ai 14-3428-10 100mm
Ai 14-3428-12 125mm
Ai 14-3428-15 150mm
Ai 14-3428-17 170mm
Ai 14-3428-20 200mm
Ai 14-3428-25 250mm

KIRSCHNER
trocar point
flat end




mm ø	60 mm	120mm	140mm	160mm	310mm
0.6	Ai 14-3429-06				
0.8	Ai 14-3429-08				
1.0	Ai 14-3429-10	Ai 14-3430-10	Ai 14-3431-10	Ai 14-3432-10	Ai 14-3433-10
1.2	Ai 14-3429-12	Ai 14-3430-12	Ai 14-3431-12	Ai 14-3432-12	Ai 14-3433-12
1.4	Ai 14-3429-14	Ai 14-3430-14	Ai 14-3431-14	Ai 14-3432-14	Ai 14-3433-14
1.5	Ai 14-3429-15	Ai 14-3430-15	Ai 14-3431-15	Ai 14-3432-15	Ai 14-3433-15
1.6	Ai 14-3429-16	Ai 14-3430-16	Ai 14-3431-16	Ai 14-3432-16	Ai 14-3433-16
1.8	Ai 14-3429-18	Ai 14-3430-18	Ai 14-3431-18	Ai 14-3432-18	Ai 14-3433-18
2.0	Ai 14-3429-20	Ai 14-3430-20	Ai 14-3431-20	Ai 14-3432-20	Ai 14-3433-20
2.2	Ai 14-3429-22	Ai 14-3430-22	Ai 14-3431-22	Ai 14-3432-22	Ai 14-3433-22
2.5	Ai 14-3429-25	Ai 14-3430-25	Ai 14-3431-25	Ai 14-3432-25	Ai 14-3433-25

KIRSCHNER
trocar point
round end



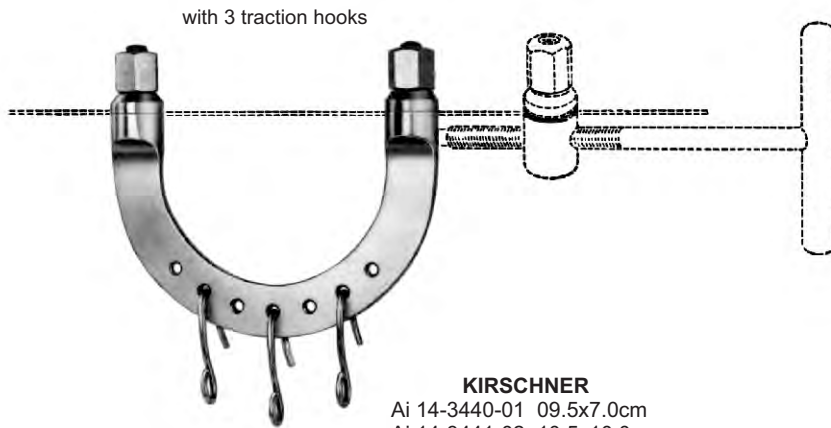
mm ø	60 mm	120mm	140mm	160mm	310mm
1.0	Ai 14-3434-10	Ai 14-3435-10	Ai 14-3436-10	Ai 14-3437-10	Ai 14-3438-10
1.2	Ai 14-3434-12	Ai 14-3435-12	Ai 14-3436-12	Ai 14-3437-12	Ai 14-3438-12
1.4	Ai 14-3434-14	Ai 14-3435-14	Ai 14-3436-14	Ai 14-3437-14	Ai 14-3438-14
1.5	Ai 14-3434-15	Ai 14-3435-15	Ai 14-3436-15	Ai 14-3437-15	Ai 14-3438-15
1.6	Ai 14-3434-16	Ai 14-3435-16	Ai 14-3436-16	Ai 14-3437-16	Ai 14-3438-16
1.8	Ai 14-3434-18	Ai 14-3435-18	Ai 14-3436-18	Ai 14-3437-18	Ai 14-3438-18
2.0	Ai 14-3434-20	Ai 14-3435-20	Ai 14-3436-20	Ai 14-3437-20	Ai 14-3438-20
2.2	Ai 14-3434-22	Ai 14-3435-22	Ai 14-3436-22	Ai 14-3437-22	Ai 14-3438-22
2.5	Ai 14-3434-25	Ai 14-3435-25	Ai 14-3436-25	Ai 14-3437-25	Ai 14-3438-25

KIRSCHNER
lancet point
flat end



mm ø	100 mm
1.0	Ai 14-3439-10
1.2	Ai 14-3439-12
1.5	Ai 14-3439-15
1.6	Ai 14-3439-16
1.8	Ai 14-3439-18
2.0	Ai 14-3439-20
2.2	Ai 14-3439-22
2.5	Ai 14-3439-25

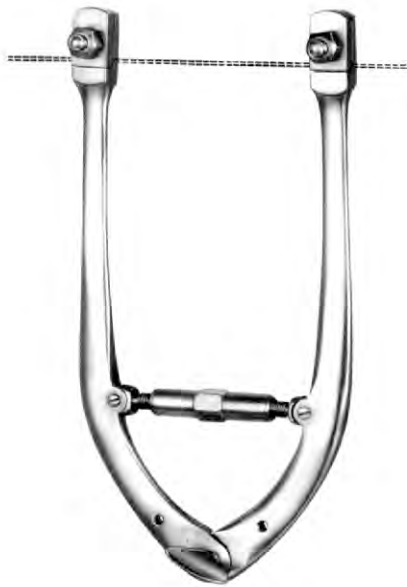




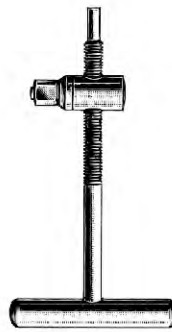
KIRSCHNER
 Ai 14-3440-01 09.5x7.0cm
 Ai 14-3441-02 10.5x10.0cm
 Ai 14-3442-03 12.0x12.0cm
 Ai 14-3443-04 15.5x15.5cm
 Ai 14-3444-05 20.0x15.5cm



KIRSCHNER
 Ai 14-3445-01
 6.0x6.0cm



Ai 14-3446-18 18.0x10.0cm
 Ai 14-3446-27 27.0x27.0cm



Ai 14-3447-18

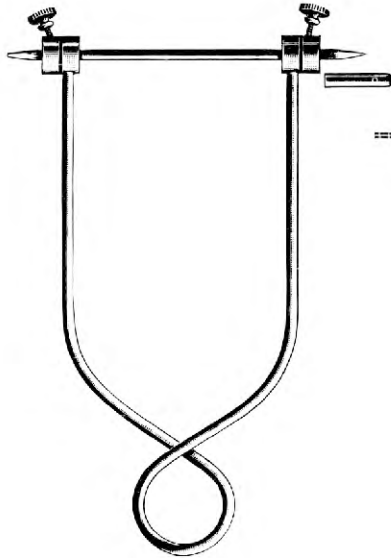


Ai 14-3448-19
 19.0cm



Ai 14-3449-03

Ai 14-3450-06



BÖHLER
 Ai 14-3451-15 21.0x15.0cm
 Ai 14-3451-16 16.0x 9.0cm
 Ai 14-3451-21 21.0x11.0cm



KIRSCHNER
 Ai 14-3452-01 13.5cm, infant
 Ai 14-3452-02 18.5cm, child
 Ai 14-3452-03 27.0cm, adult



MARTIN-DIAMANT
 Ai 14-3453-16
 16 cm/6 1/4"



Ai 14-3454-16
 16 cm/6 1/4"



Ai 14-3455-15
 15 cm/6"



Ai 14-3456-23
 23 cm/9"



Ai 14-3456-25
 25 cm/10"











Ai 14-3457-24
 24 cm/9 1/4"














WILLIGER
17.5 cm/7"

- | | |
|---|---|
|  |  |
| Fig. 00
Ai 14-3458-20 | Fig. 00
Ai 14-3459-20 |
|  |  |
| Fig. 0
Ai 14-3458-10 | Fig. 0
Ai 14-3459-10 |
|  |  |
| Fig. 01
Ai 14-3458-01 | Fig. 01
Ai 14-3459-01 |
|  |  |
| Fig. 02
Ai 14-3458-02 | Fig. 02
Ai 14-3459-02 |









BRUNS
23 cm/9"

- | | |
|---|---|
|  |  |
| Ai 14-3460-30 | Ai 14-3460-20 |
|  |  |
| Ai 14-3460-10 | Ai 14-3460-01 |
|  |  |
| Ai 14-3460-02 | Ai 14-3460-03 |
|  |  |
| Ai 14-3460-04 | Ai 14-3460-05 |
|  | |
| Ai 14-3460-06 | |

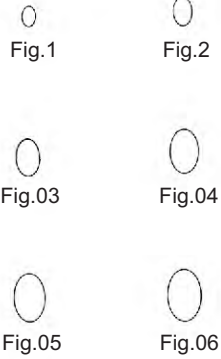


SIMON
24 cm/9 1/4"

- | | |
|---|---|
|  |  |
| Ai 14-3461-01 | Ai 14-3461-02 |
|  |  |
| Ai 14-3461-03 | Ai 14-3461-04 |
|  |  |
| Ai 14-3461-05 | Ai 14-3461-06 |



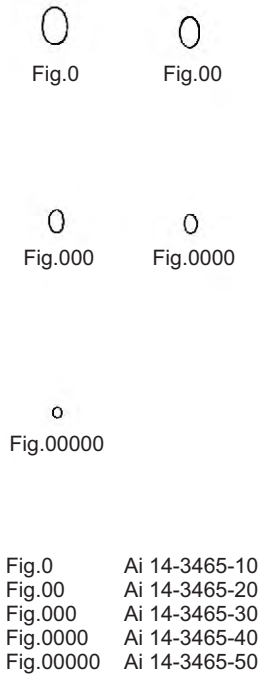
MOD. USA
 16 cm/6 1/4"



- | | | | |
|-------|---------------|---------------|---------------|
| Fig.1 | Ai 14-3462-01 | Ai 14-3463-01 | Ai 14-3464-01 |
| Fig.2 | Ai 14-3462-02 | Ai 14-3463-02 | Ai 14-3464-02 |
| Fig.3 | Ai 14-3462-03 | Ai 14-3463-03 | Ai 14-3464-03 |
| Fig.4 | Ai 14-3462-04 | Ai 14-3463-04 | Ai 14-3464-04 |
| Fig.5 | Ai 14-3462-05 | Ai 14-3463-05 | Ai 14-3464-05 |
| Fig.6 | Ai 14-3462-06 | Ai 14-3463-06 | Ai 14-3464-06 |



LEMPERT
 17.5 cm/7"



- | | |
|-----------|---------------|
| Fig.0 | Ai 14-3465-10 |
| Fig.00 | Ai 14-3465-20 |
| Fig.000 | Ai 14-3465-30 |
| Fig.0000 | Ai 14-3465-40 |
| Fig.00000 | Ai 14-3465-50 |



HALLE
 21 cm/8 1/4"

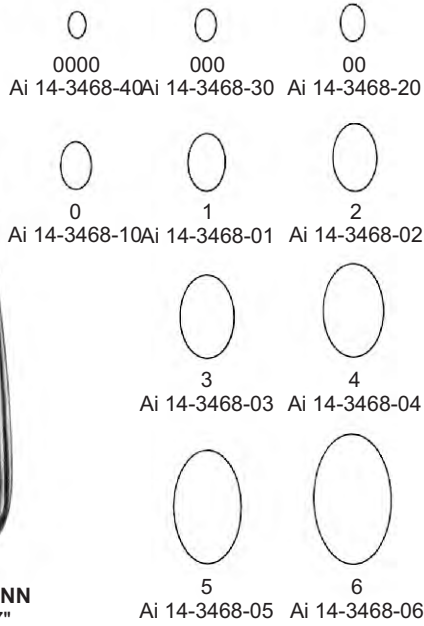


25 cm/10"

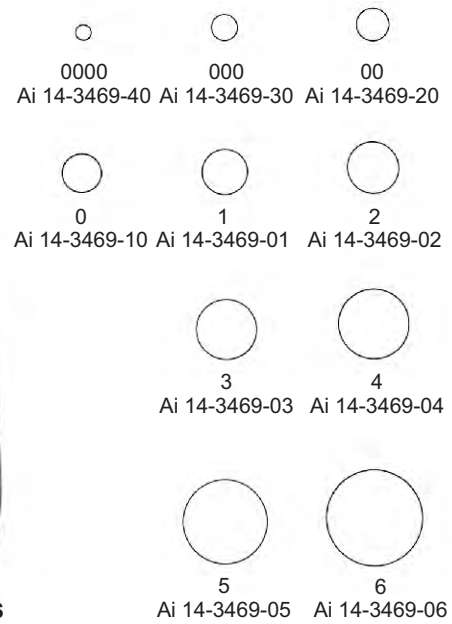




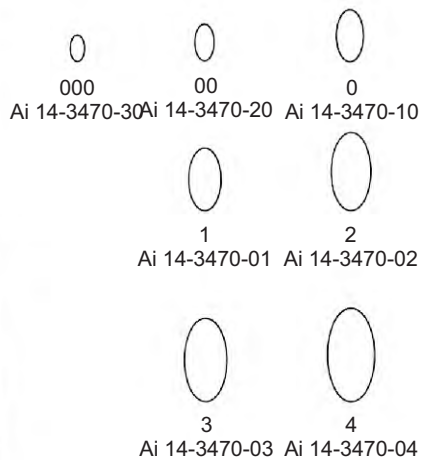
VOLKMANN
17 cm/7"



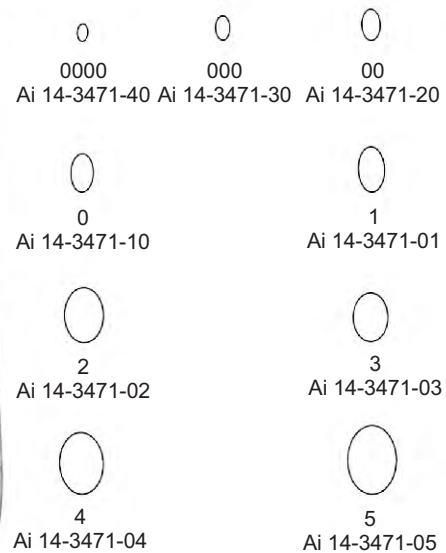
BRUNS
17 cm/7"

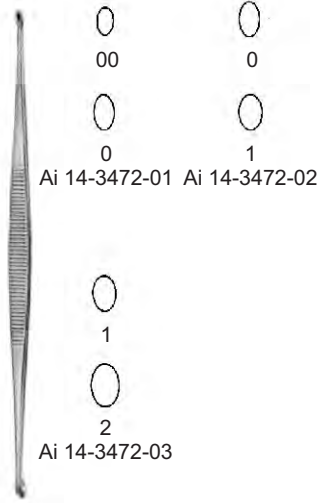


SCHEDE
17 cm/7"

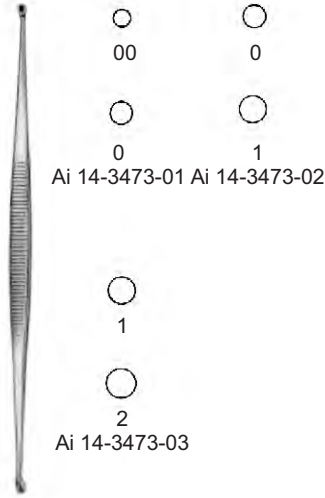


SPRATT
16.5 cm/6 3/4"





WILLIGER
 13.5 cm/5 1/4"



MARTINI
 13.5 cm/5 1/4"



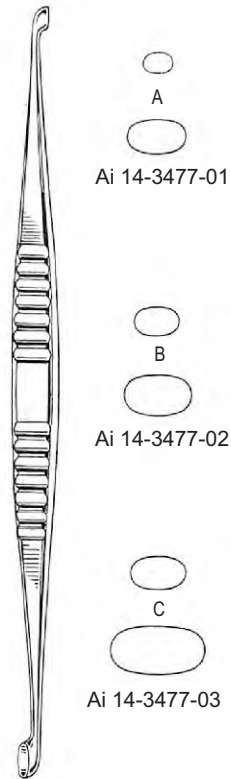
VOLKMANN
 Ai 14-3474-13 13 cm/5"
 Ai 14-3474-14 14 cm/5 1/2"
 Ai 14-3474-17 17 cm/7"



VOLKMANN
 Ai 14-3475-13 13 cm/5 1/4"
 Ai 14-3475-16 16 cm/6 1/4"
 Ai 14-3475-20 20 cm/8"



Ai 14-3476-21
 21 cm/8 1/4"

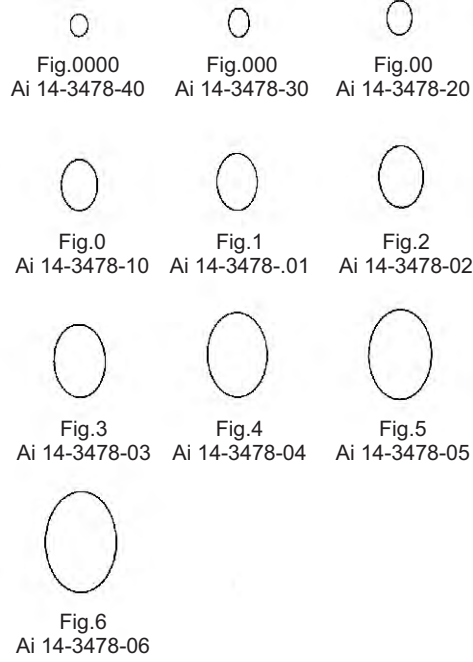


VOLKMANN
 21.5 cm/8 1/2"



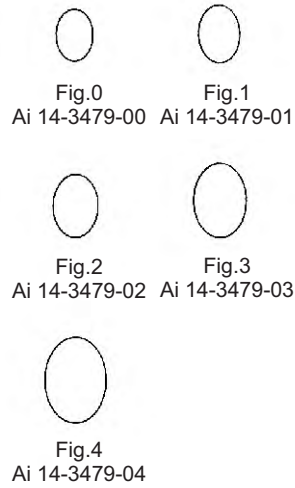


VOLKMANN
 17 cm/6 3/4"





VOLKMANN
27 cm/10 3/4"

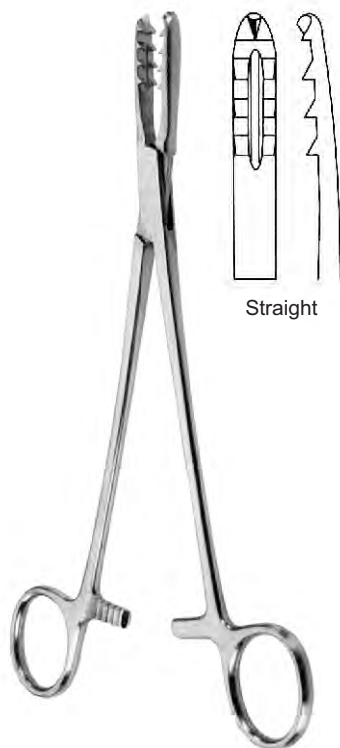




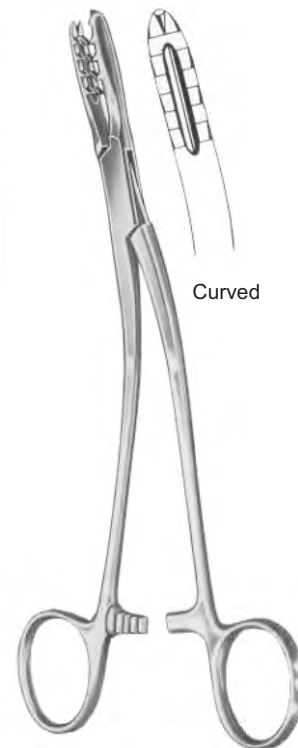
Martin
Ai 14-3482-19
19 cm/7½"



Preston
Ai 14-3483-18
18 cm/7¼"



Bircher-Ganske
Ai 14-3484-20
20 cm/8"



Bircher-Ganske
Ai 14-3485-20
20 cm/8"



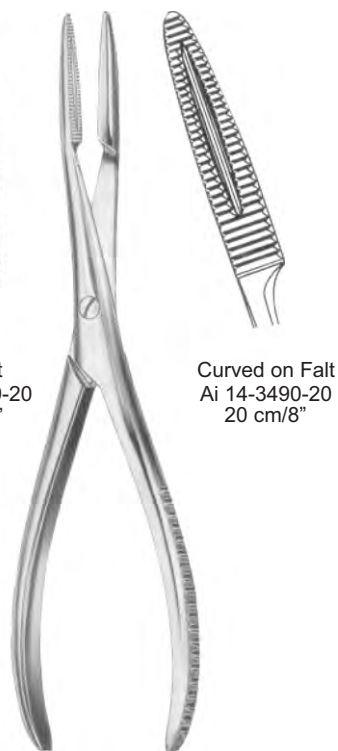
Lewin
Ai 14-3486-17
17.5 cm/7"



Langenbeck
Ai 14-3487-21
21 cm/8¼"



Fergusson
Ai 14-3488-21
21 cm/8¼"



Van Buren
Ai 14-3491-23
23 cm/9"



Dingmann
Ai 14-3492-19
19cm/7 1/2"



Dingmann Modif
Ai 14-3493-19
19 cm/7 1/2"



Neff
Ai 14-3494-21
21 cm/8 1/4"





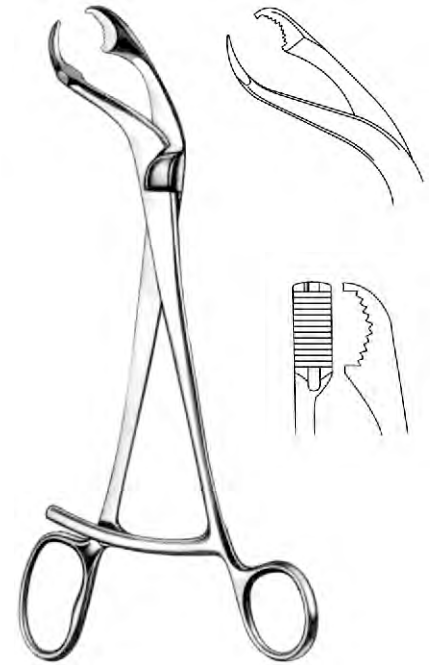
Semb
 Ai 14-3495-19
 19 cm/7½"



Semb
 Ai 14-3496-19
 19 cm/7½"



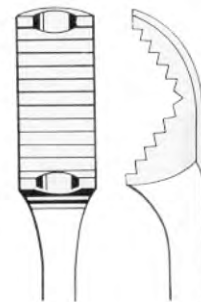
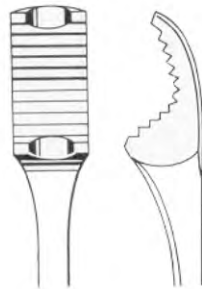
Verbrugge
 Ai 14-3497-01
 17.5 cm/7"



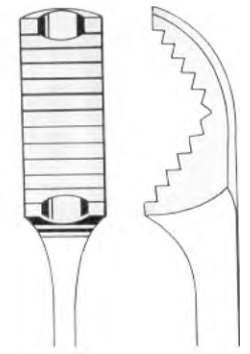
Verbrugge
 Ai 14-3497-02
 17.5 cm/7"



Ai 14-3498-25
 25 cm/10"



Ai 14-3499-26
 26 cm/10¼"
Vebrugge



Ai 14-3500-27
 27 cm/10½"

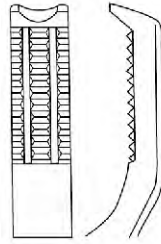




Ai 14-3501-16
16 cm/6¼"
Ai 14-3501-24
24 cm/9½"



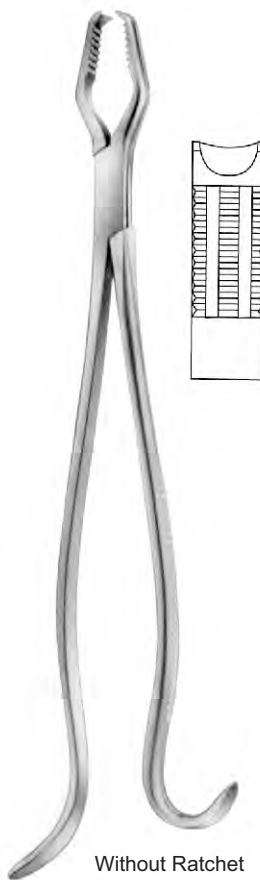
Without Ratchet
Ai 14-3502-17
Ai 14-3502-21



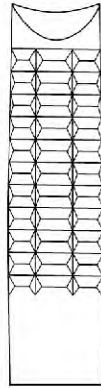
Kern
cm in
17 6¾"
21 8¼"



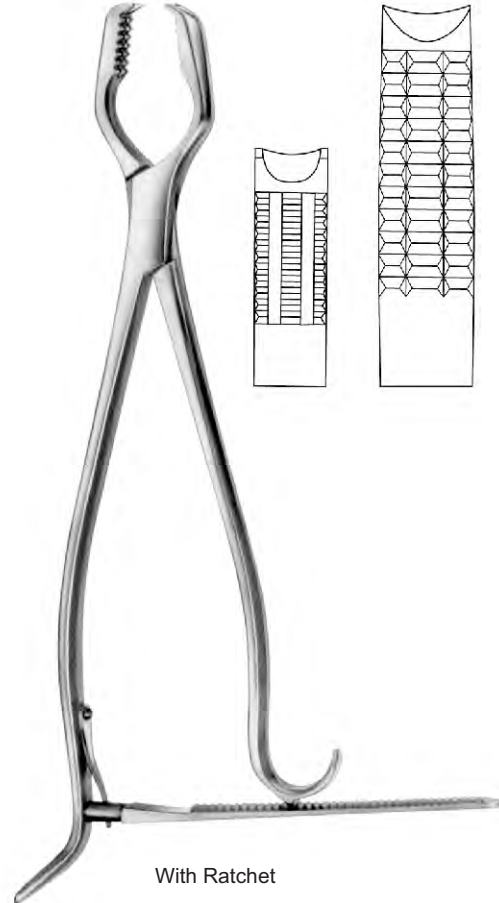
With Ratchet
Ai 14-3503-17
Ai 14-3503-21



Without Ratchet
Ai 14-3504-33
Ai 14-3504-45



Lane
cm in
33 13"
45 17¾"

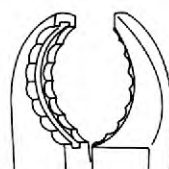
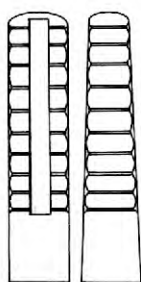


With Ratchet
Ai 14-3505-33
Ai 14-3505-45





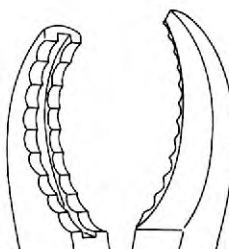
ULRICH



Ai 14-3506-23 23.0cm
 Ai 14-3507-22 22.0cm



Ai 14-3506-25 25.0cm
 Ai 14-3507-24 24.0cm



Ai 14-3506-28 28.0cm
 Ai 14-3507-27 27.0cm



ULRICH



Ai 14-3508-19 19 cm/8 3/4"
Ai 14-3508-26 26 cm/10 1/4"



ULRICH
Ai 14-3508-00
28 cm/11"





Farabeuf-Lambotte
 Ai 14-3509-26
 26 cm/10¼"



Lambotte
 Ai 14-3510-19 19 cm/7½"
 Ai 14-3510-23 23 cm/9"
 Ai 14-3510-26 26 cm/10¼"



Ai 14-3511-13
 13.5 cm/5¼"



Bruns
 Ai 14-3511-18
 18.5 cm/7¼"



Ai 14-3511-14
 14.5 cm/5¾"



Ai 14-3512-12
 12 cm/4¾"



Ai 14-3512-21
 21 cm/8¼"



Ai 14-3512-14
 14 cm/5½"

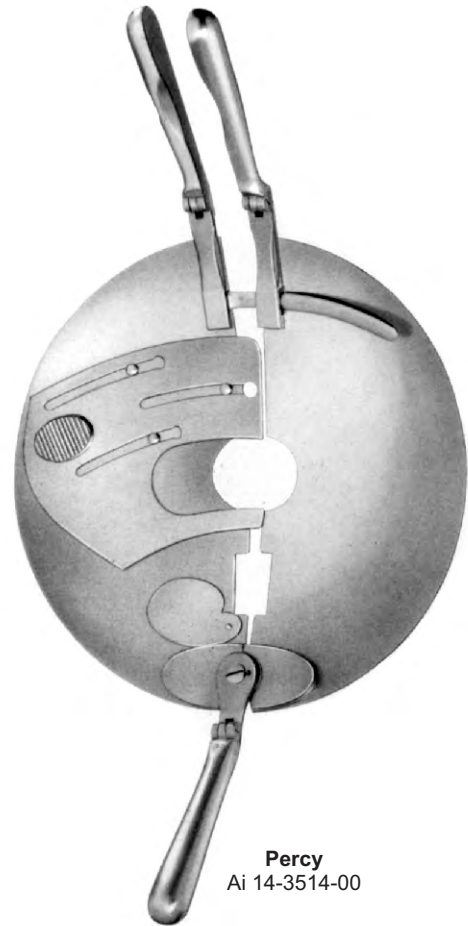


Ai 14-3513-15 15 cm/6"
Ai 14-3513-19 19 cm/7 1/2"
Ai 14-3513-24 24 cm/9 1/2"
Ai 14-3513-26 26 cm/10 1/4"
Ai 14-3513-28 28 cm/11"



Handles Detachable

Percy
Ai 14-3514-30



Percy
Ai 14-3514-00

Adjustable



Lambotte
Ai 14-3515-22 22 cm/8 3/4"
Ai 14-3515-27 27 cm/10 1/2"
Ai 14-3515-30 30 cm/12"



Farabeuf
Ai 14-3516-23 23 cm/9"
Ai 14-3516-26 26 cm/10 1/4"



Lambotte
Ai 14-3517-22 22.5 cm/9"
Ai 14-3517-25 25.5 cm/10 1/2"
Ai 14-3517-33 33 cm/13 1/2"



Haase
Ai 14-3517-16
16.5 cm/6 1/2"





Ai 14-3518-19
19 cm/7 3/4"



Ai 14-3519-23
23 cm/9"



Ai 14-3520-25
25 cm/10"





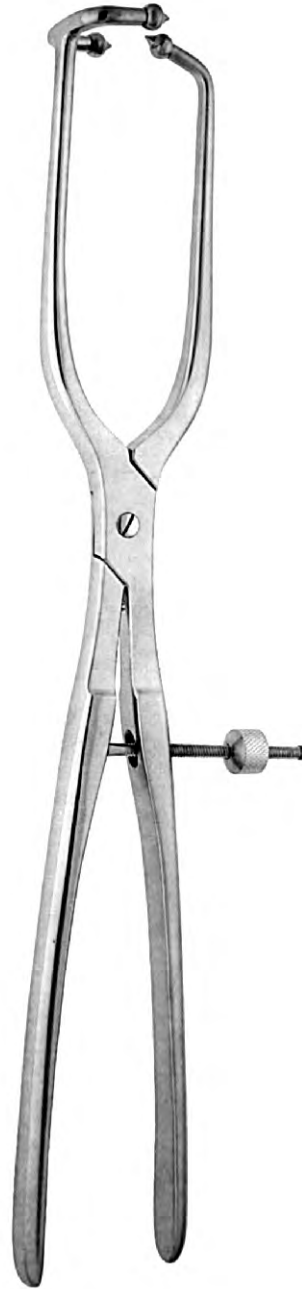
FROSCH
Ai 14-3521-18
18 cm/7"



Ai 14-3522-20
20 cm/8"



Ai 14-3523-18
18.5 cm/7 1/2"



Ai 14-3524-40
40 cm/16"



Ai 14-3525-40
40 cm/16"





TUFFIER
 Ai 14-3526-27
 27 cm/10 3/4"



Ai 14-3527-19 19 cm/7 3/4"
 Ai 14-3527-26 26 cm/10 1/4"



ULRICH
 Ai 14-3528-28
 28 cm/11"





Ai 14-3529-13
13.5 cm/5 1/4"

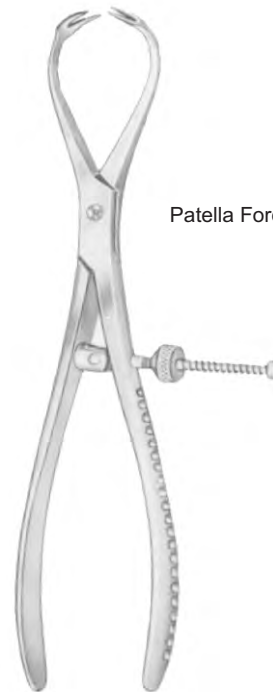


Ai 14-3530-20
20 cm/8"





Reall
Ai 14-3531-17
17 cm/6¾"



Patella Forceps

Ai 14-3532-17
17.5 cm/7"

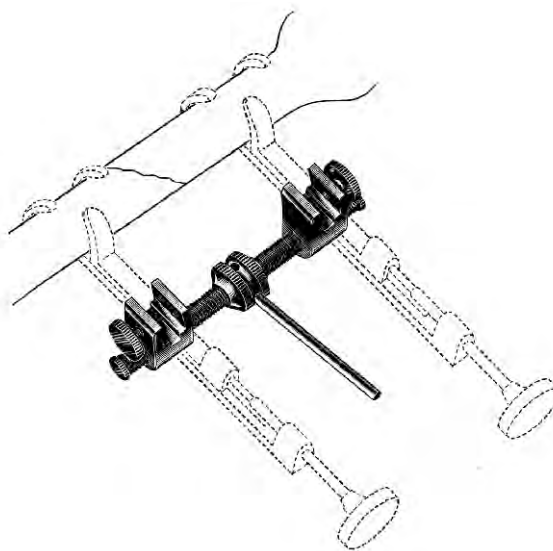


LOWMAN
Ai 14-3533-12 12.0cm
Ai 14-3533-18 18.5cm
Ai 14-3533-20 20.0cm
Ai 14-3533-22 22.0cm

GERSTER-LOWMANN
Ai 14-3534-18 18.0cm
Ai 14-3534-20 20.0cm
Ai 14-3534-22 22.0cm

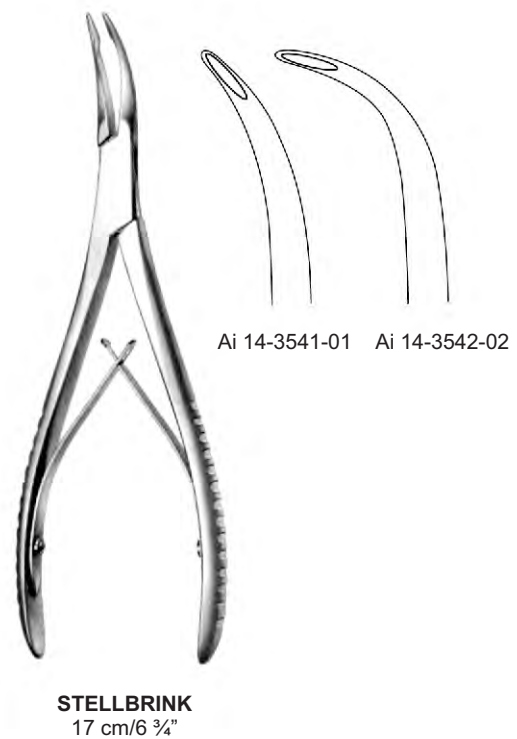
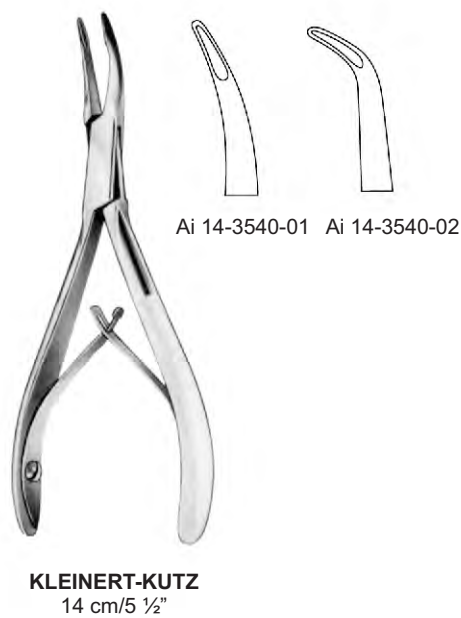
LAMBERT-LOWMAN
2x2 prongs
Ai 14-3535-18 18.0cm
Ai 14-3535-20 20.0cm
Ai 14-3535-22 22.0cm

LOWMAN-HOGLUND
Ai 14-3536-12 12.0cm
Ai 14-3536-17 17.5cm
Ai 14-3536-20 20.0cm
Ai 14-3536-22 22.0cm



GERSTER
Ai 14-3537-15







MINI-FRIEDMAN
Ai 14-3543-12
12 cm/4 ¾"



FRIEDMAN
Ai 14-3544-14
14 cm/5 ½"



MEAD
Ai 14-3545-16
16.5 cm/6 ½"



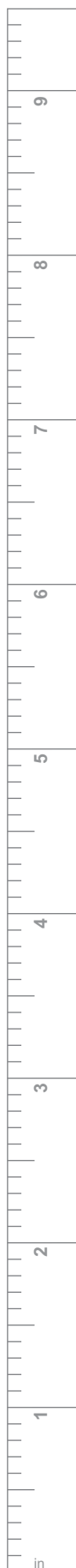
MEAD
Ai 14-3546-16
16.5 cm/6 ½"



HARTMANN
Ai 14-3547-16
16 cm/6 ¼"



HARTMANN
Ai 14-3548-18
18.5 cm/7 ¼"





JANSEN
18 cm/7"



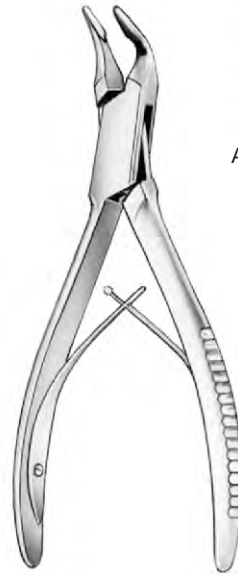
Ai 14-3552-01



Ai 14-3552-02



Ai 14-3552-03



BLUMENTHAL
15 cm/6"



Ai 14-3553-01



Ai 14-3553-02



Ai 14-3553-03



LEMPERT
20 cm/8"



Ai 14-3554-20

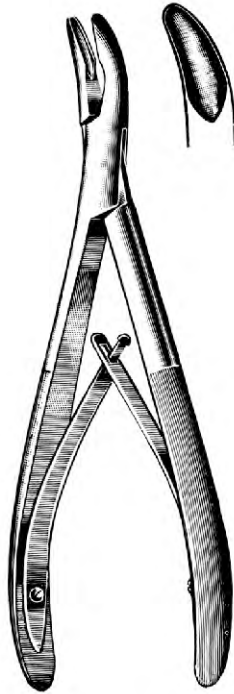


Ai 14-3555-20



DEFOURMENTEL
Ai 14-3556-19
19 cm/7 3/4"





BANE
 Ai 14-3557-18
 18 cm/7"



ADSON
 Ai 14-3558-21
 21 cm/8 1/4"



BACON
 Ai 14-3559-20
 20 cm/8"



FISCH
 17 cm/6 3/4"



Ai 14-3560-01



Ai 14-3560-02





LUER
Ai 14-3561-01
15 cm/6"



LUER
Ai 14-3561-02
15 cm/6"



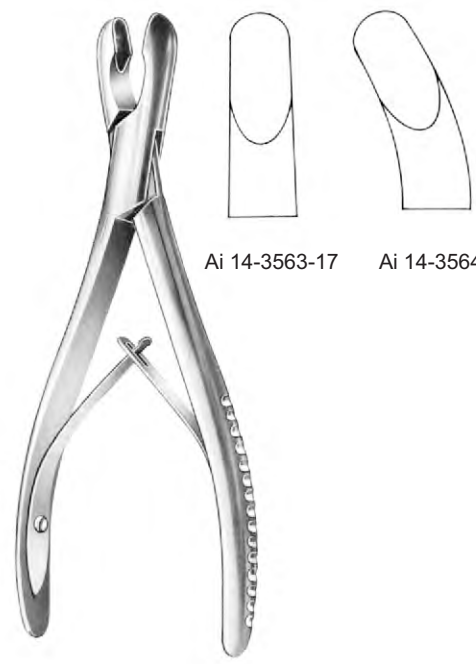
LUER
Ai 14-3561-03
15 cm/6"



LUER
Ai 14-3562-01
15 cm/6"



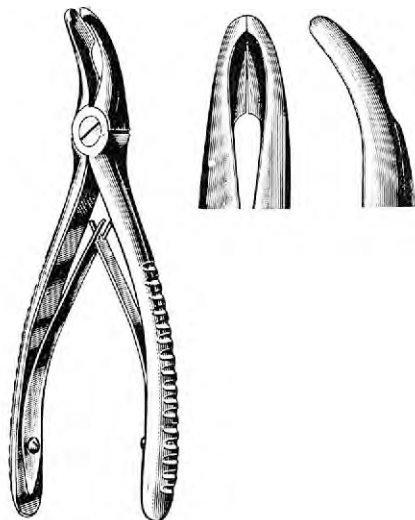
LUER
Ai 14-3562-02
15 cm/6"



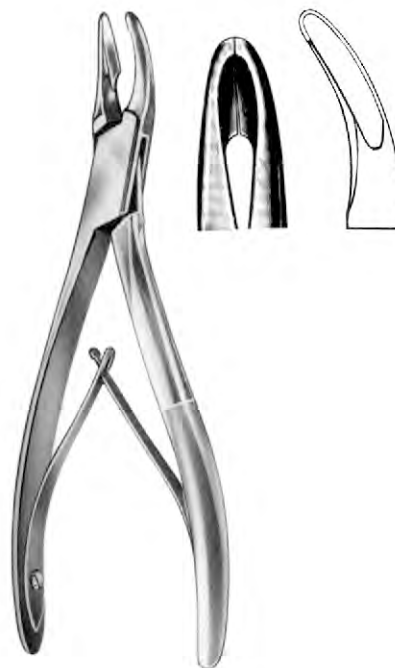
Ai 14-3563-17

Ai 14-3564-17

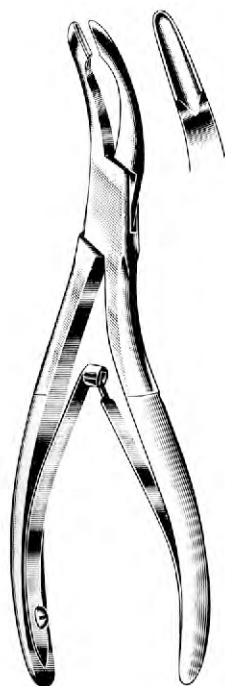
LUER
17 cm/6 3/4"



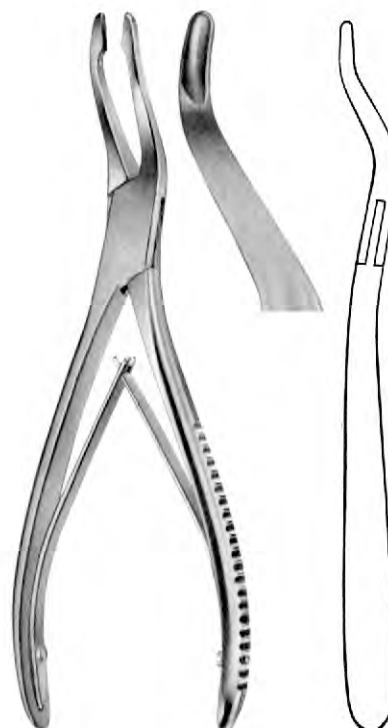
UNIVERSAL
Ai 14-3565-13
13.5 cm/5 1/4"



SHELL
Ai 14-3566-17
17 cm/6 3/4"

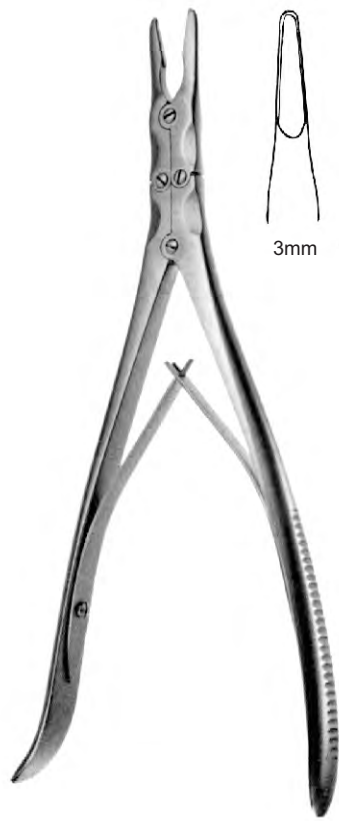


COTTLE-JANSEN
Ai 14-3567-18
18 cm/7"

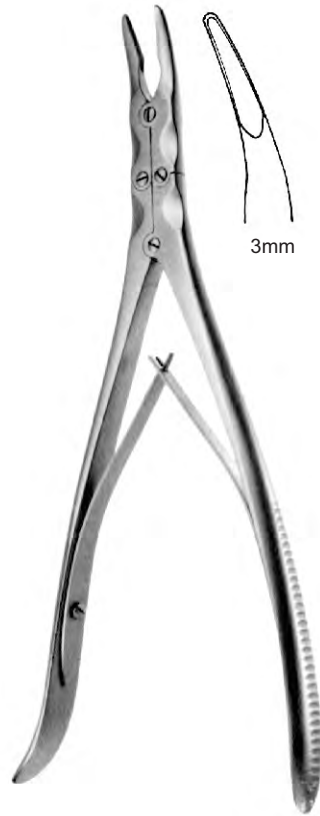


JANSEN
Ai 14-3568-19
19 cm/7 1/2"





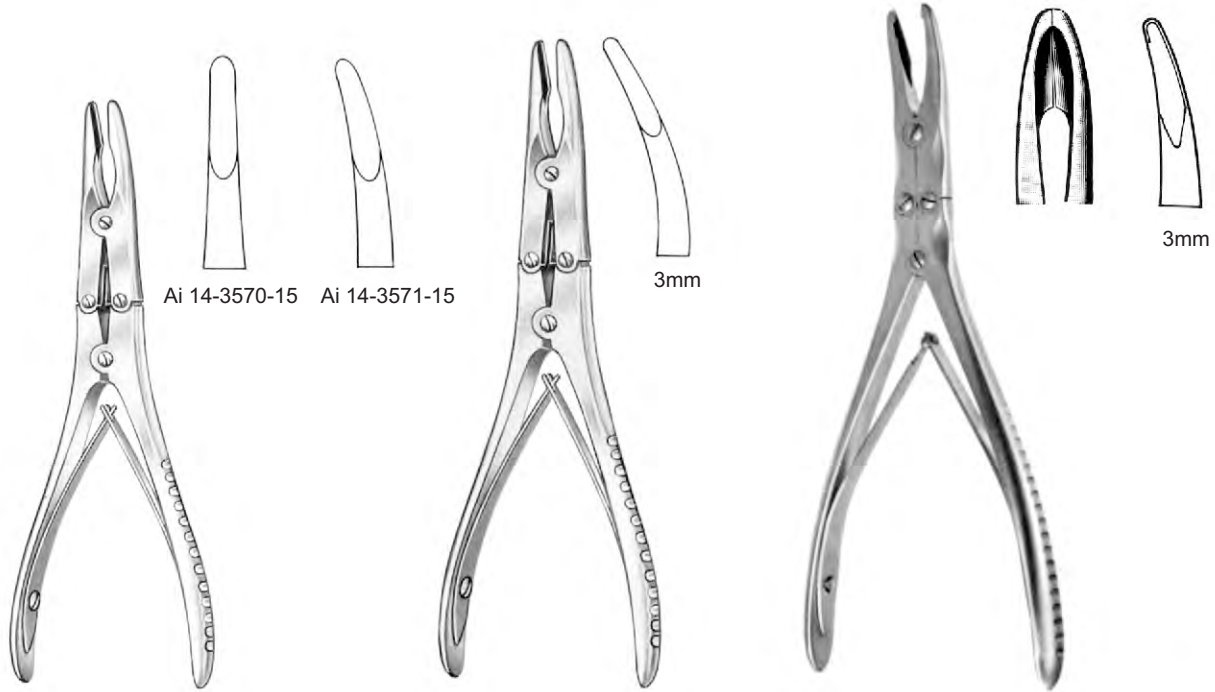
SMITH-PETERSEN
 Ai 14-3569-01
 24 cm/9 1/2"



SMITH-PETERSEN
 Ai 14-3569-02
 24 cm/9 1/2"



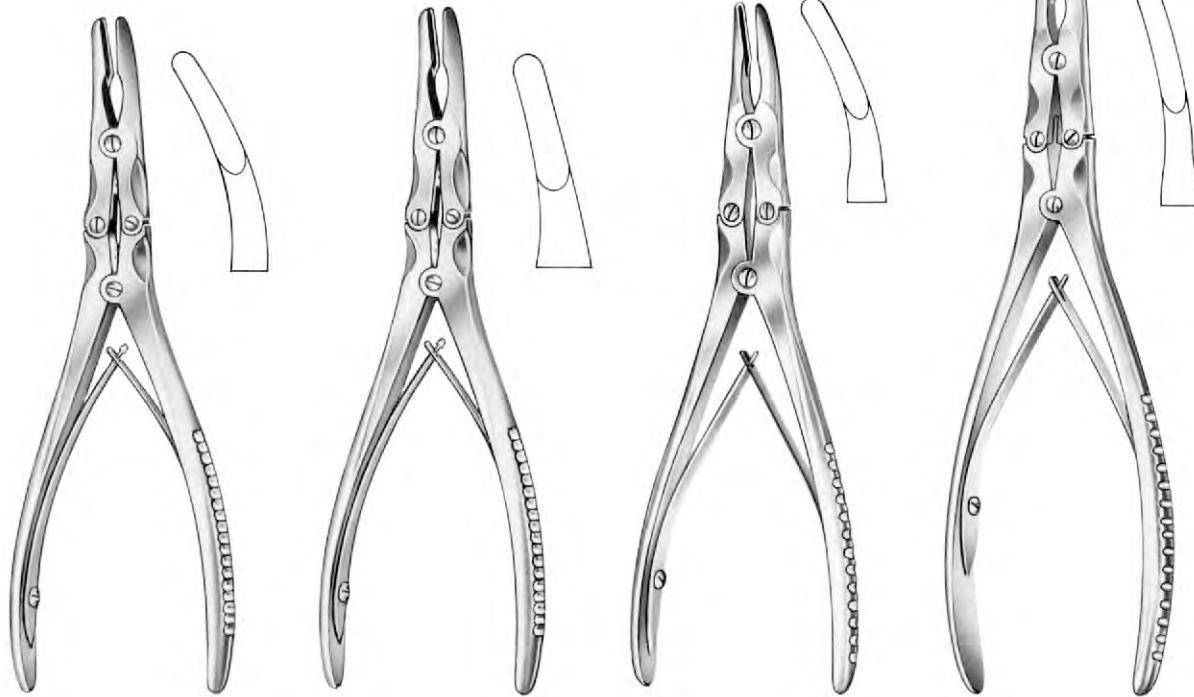
SMITH-PETERSEN
 Ai 14-3569-03
 24 cm/9 1/2"



BÖHLER
15 cm/6"

KLEINERT-KUTZ
Ai 14-3572-15
15 cm/6"

GEIGER
Ai 14-3573-15
15 cm/6"



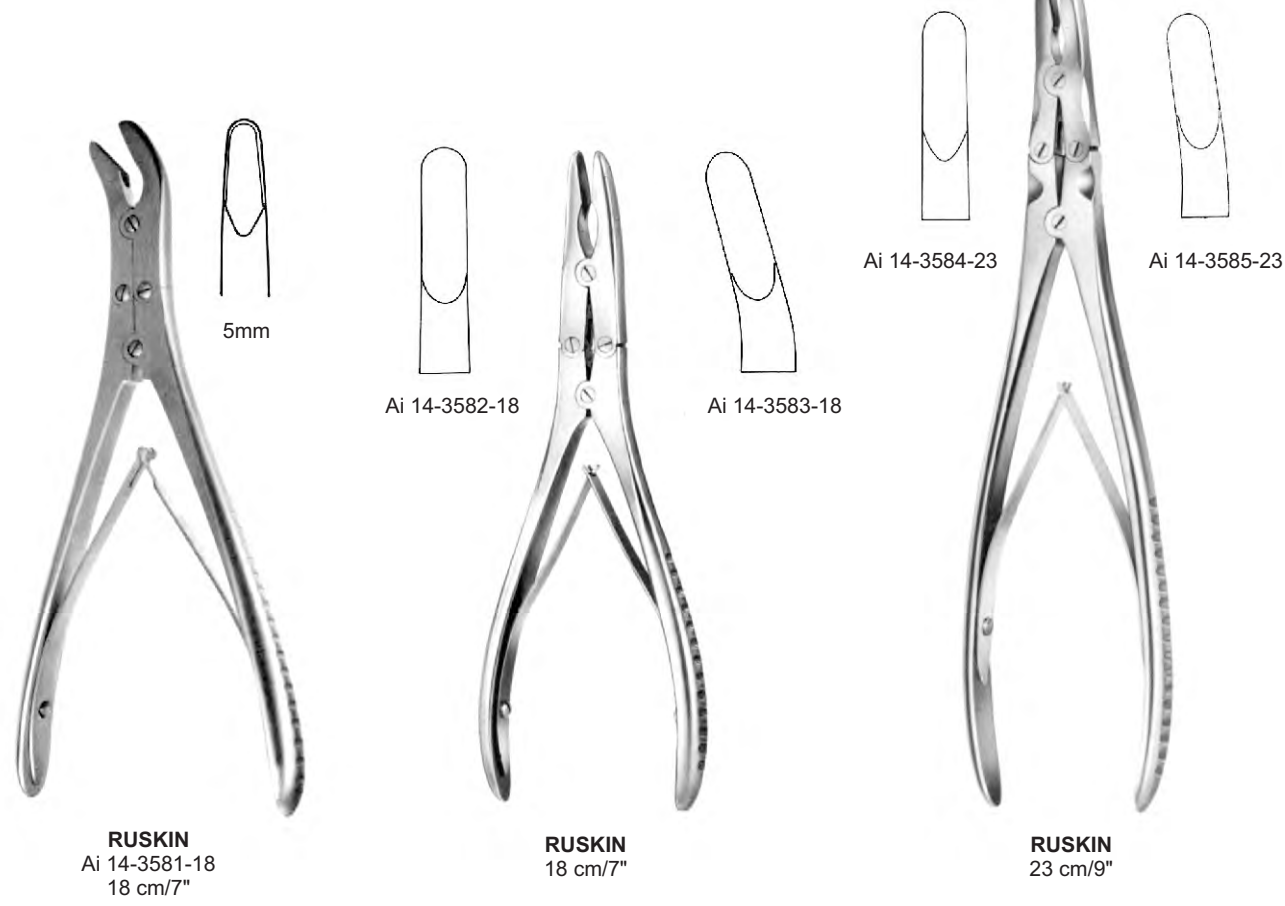
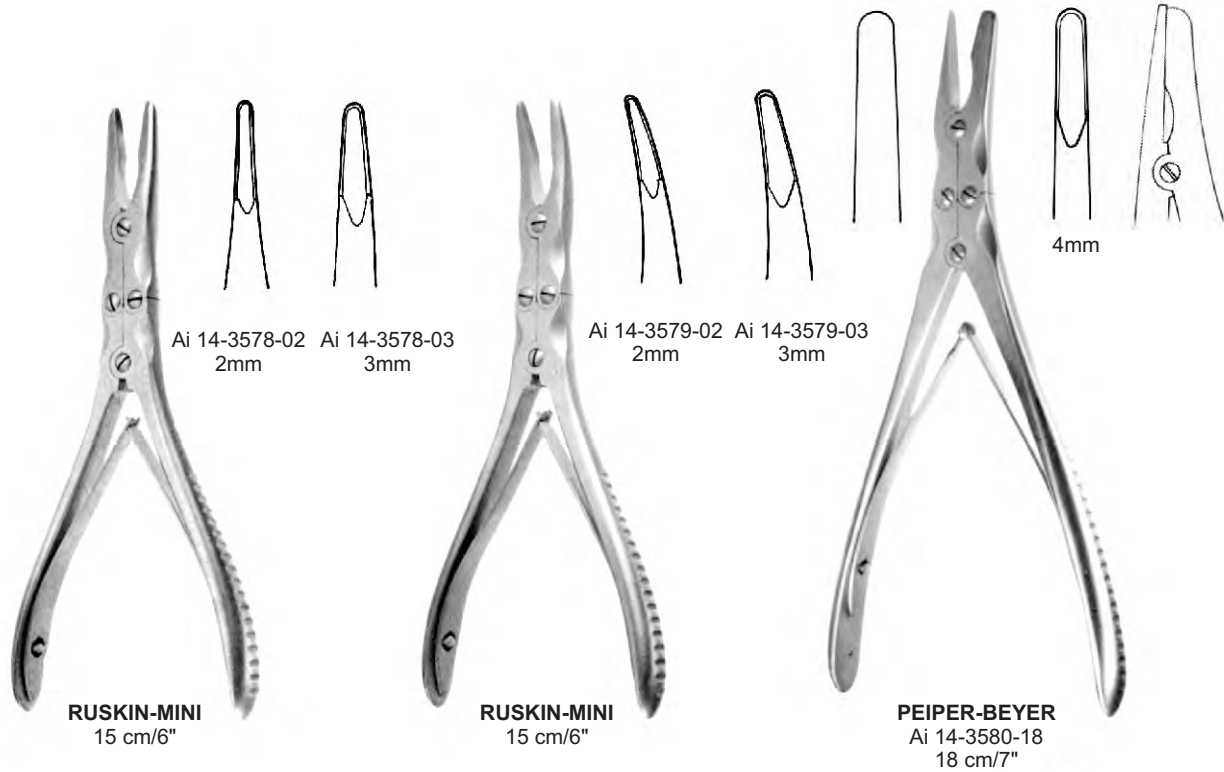
BEYER
Ai 14-3574-18
18 cm/7"

ZAUFAL-JANSEN
Ai 14-3575-18
18 cm/7"

MAYFIELD
Ai 14-3576-17
17 cm/6 3/4"

MARQUARDT
Ai 14-3577-20
20 cm/8"







FRYKHOLM
Ai 14-3586-24
24 cm/9 1/2"



Ai 14-3587-02 Ai 14-3587-03 Ai 14-3587-04

ECHLIN
23 cm/9"



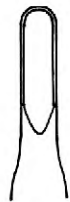


5mm

STILLE-LEKSELL
 Ai 14-3588-23
 23 cm/9"



LEKSELL
 23 cm/9"



Ai 14-3589-05
 5mm



Ai 14-3589-08
 8mm



LEKSELL-STILLE
 24 cm/9 1/4"



Ai 14-3590-01
 8 mm



Ai 14-3590-02
 4 mm



STILLE
Ai 14-3591-23
23 cm/9"

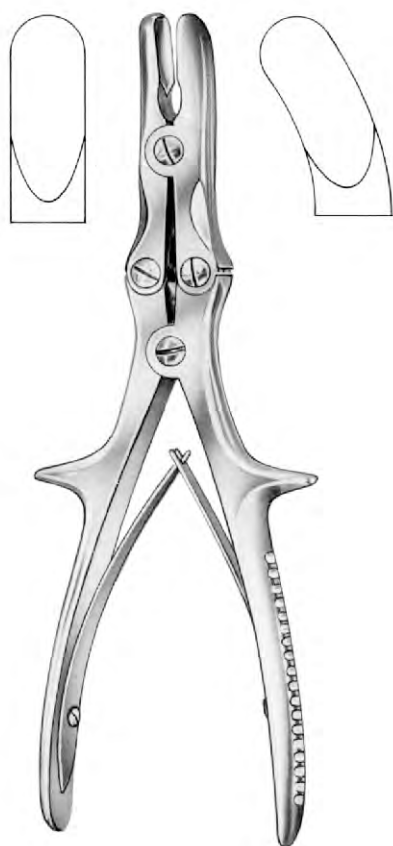


STILLE-RUSKIN
Ai 14-3592-01 23 cm/9" Ai 14-3592-02



SEMB
Ai 14-3593-22
22.5 cm/9"





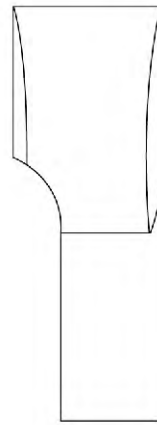
STILLE-LUER
 Ai 14-3594-01 22 cm/8 3/4" Ai 14-3594-02



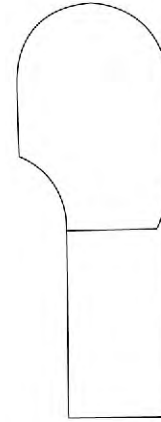
STILLE-LUER
 Ai 14-3595-23 23 cm/9" Ai 14-3596-23
 Ai 14-3595-27 27 cm/10 3/4" Ai 14-3596-27



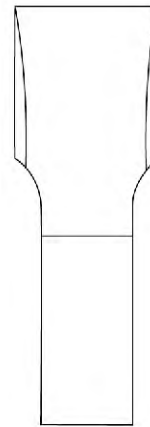
SAUERBRUCH
30 cm/12"



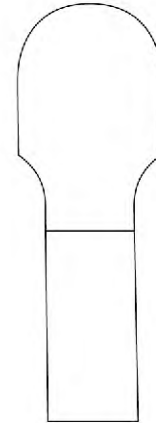
Ai 14-3597-01



Ai 14-3597-02

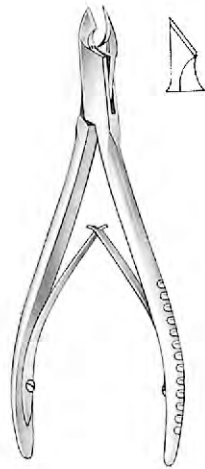


Ai 14-3598-01

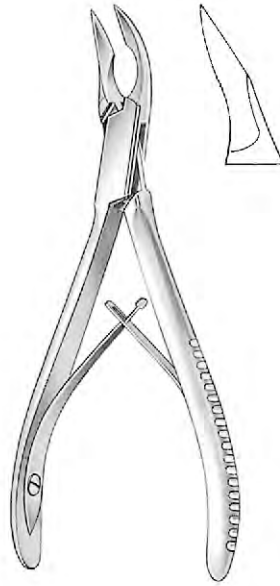


Ai 14-3598-02

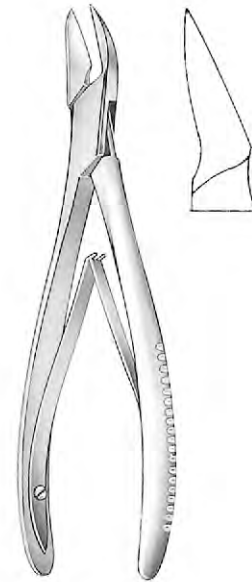




Ai 14-3599-12
12 cm/5"



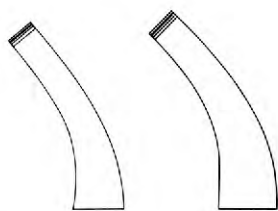
CLEVELAND
Ai 14-3600-15
15 cm/6"



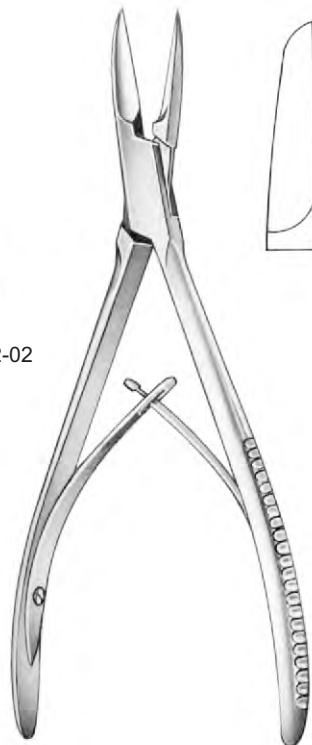
CLEVELAND
Ai 14-3601-17
17 cm/6 3/4"



CLEVELAND
16 cm/6 1/2"



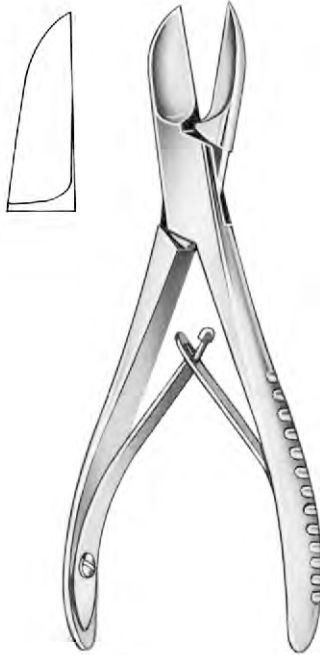
Ai 14-3602-01 Ai 14-3602-02



COTTLE-KAZANJIAN
Ai 14-3603-19
19 cm/7 3/4"

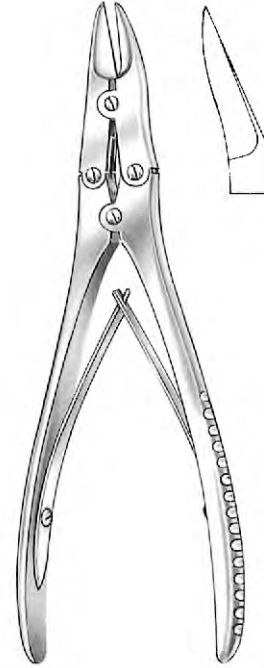


MARKWALDER
Ai 14-3604-20
20 cm/8"



LISTON

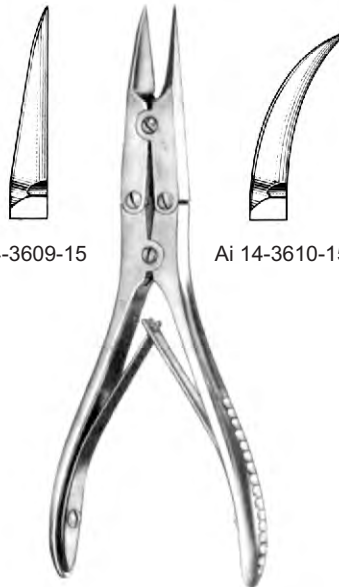
Ai 14-3605-14 14.0cm Ai 14-3606-14
 Ai 14-3605-17 17.0cm Ai 14-3606-17
 Ai 14-3605-19 19.0cm Ai 14-3606-19
 Ai 14-3605-22 22.0cm Ai 14-3606-22



MC INDOE
 Ai 14-3607-17
 17.5 cm/7"



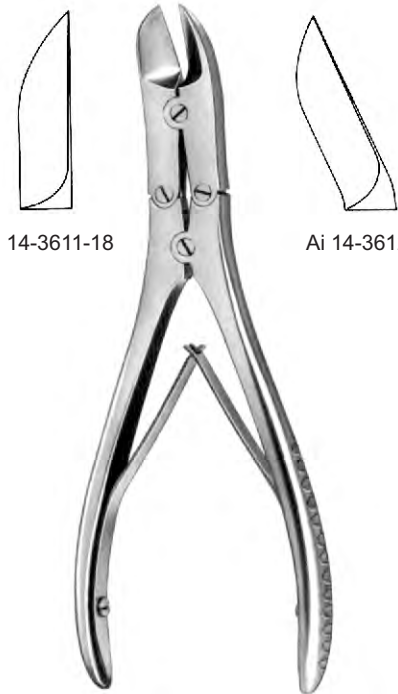
Bouier
 Ai 14-3608-15
 15 cm/6"



Ai 14-3609-15

Ai 14-3610-15

15 cm/6"



Ai 14-3611-18

Ai 14-3612-18

RUSKIN-LISTON
 18.5 cm/7 1/2"





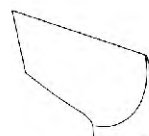
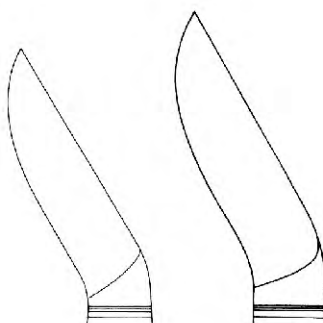
TUDOR-EDWARDS
 Ai 14-3613-23
 23 cm/9"



SEMB
 Ai 14-3614-24
 24 cm/9 3/4"



STILLE-LISTON
 Ai 14-3615-27
 27 cm/10 3/4"



Ai 14-3617-23 Ai 14-3617-27



STILLE LISTON
Ai 14-3616-27
27 cm/10 3/4"

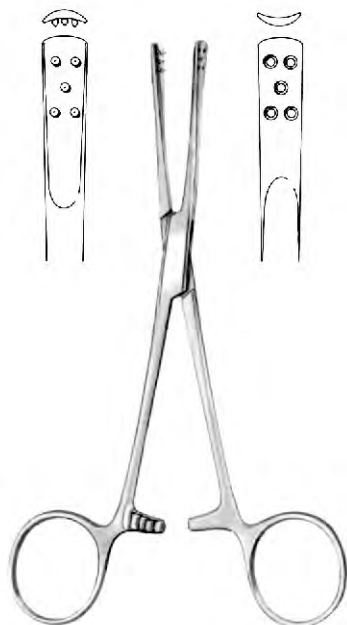


STILLE LISTON
Ai 14-3617-23 23 cm/9"
Ai 14-3617-27 27 cm/10 3/4"



LISTON KEY
Ai 14-3618-27
27 cm/10 3/4"





PENNER
 Ai 14-3619-15
 15 cm/6"



RADOLF
 Ai 14-3620-13
 13.5 cm/5 1/2"



Ai 14-3621-01 saw
 Ai 14-3621-02 key

Ai 14-3621-00
 17 cm/7"



Ai 14-3622-01 saw
 Ai 14-3622-02 key

Ai 14-3622-00
 17 cm/7"



Ai 14-3623-01 saw
 Ai 14-3623-02 key

WALTON
 Ai 14-3623-00
 16 cm/5 1/2"



Ai 14-3624-01 saw
 Ai 14-3624-02 key

Ai 14-3624-00



Ai 14-3625-26
26.5 cm/10 1/2"



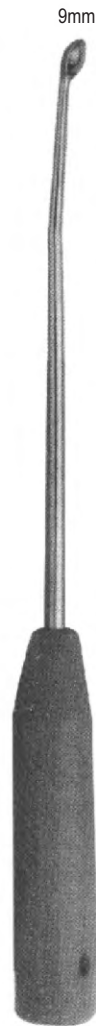
Ai 14-3626-27
27 cm/10 3/4"



Ai 14-3627-28
28 cm/11"



Ai 14-3628-28
28 cm/11"








Ai 14-3629-00








BUNNELL
15 cm/6"

-  Ai 14-3630-01
3mm
-  Ai 14-3630-02
4mm
-  Ai 14-3630-03
5mm
-  Ai 14-3630-04
6mm
-  Ai 14-3630-05
7mm



23.0 cm/9"

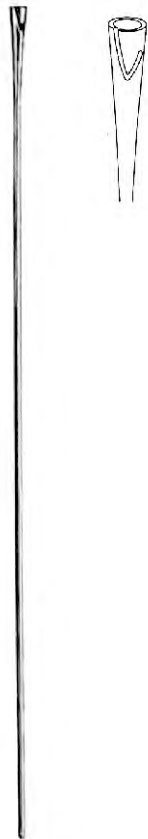
-  Ai 14-3631-40
4mm
-  Ai 14-3631-45
4.5mm
-  Ai 14-3631-55
5.5mm



Ai 14-3632-33
33.5 cm/13"



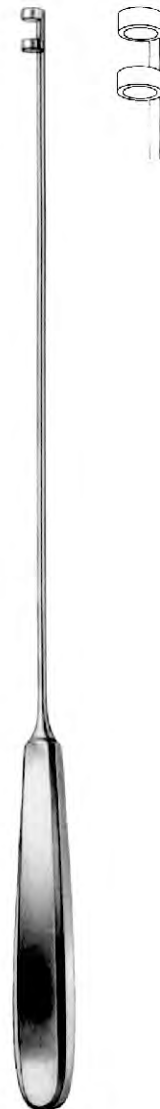
Ai 14-3632-01
screw only



BUNNEL
Ai 14-3633-23
23 cm/9"



Ai 14-3634-28
28.5 cm/11 ¼"



FISCHER
Ai 14-3635-31
31 cm/10 ¼"





IDEAL
 Ai 14-3636-00 handle only
 Ai 14-3636-01 set



Ai 14-3636-02



Ai 14-3636-03



Ai 14-3636-04



Ai 14-3637-01 adult
 Ai 14-3637-02 child

- EN** Plaster Instruments
- DE** Plaster Instrumente
- ES** Instrumentos de yeso

Page 269 to 274





Lister

- Ai 15-3801-09 09.0 cm/3½"
- Ai 15-3801-11 11.5 cm/4½"
- Ai 15-3801-14 14.0 cm/5½"
- Ai 15-3801-15 15.5 cm/6"
- Ai 15-3801-18 18.0 cm/7"
- Ai 15-3801-20 20.0 cm/8"



Lister

- Ai 15-3802-18 18.5 cm/7¼"
- Ai 15-3802-21 21.0 cm/8¼"



Lister-Excentric

- Ai 15-3803-16 16 cm/6¼"
- Ai 15-3803-19 19 cm/7½"



Esmarch

- Ai 15-3804-20 20 cm/8"
- Ai 15-3804-22 22 cm/8¾"



Bergmann

- Ai 15-3805-23 23 cm/9"



Lorenz

- Ai 15-3806-23 23 cm/9"



Saw edge

Ai 15-3807-17
17 cm/6¾"



Lange
Ai 15-3808-18
18 cm/7"



Bruns
Ai 15-3809-24
24 cm/9½"
TC



Smith (Mod. USA)
Ai 15-3810-16 16 cm
Ai 15-3810-18 18 cm
Ai 15-3810-20 20 cm
Ai 15-3810-23 23 cm



Knowles
Ai 15-3811-14
14 cm/5½"

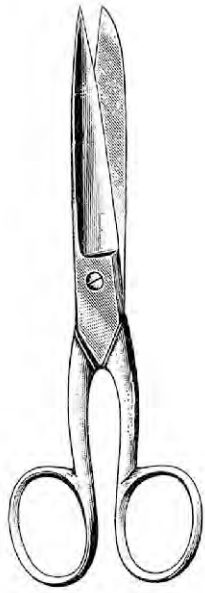


Knowles
Ai 15-3812-14
14 cm/5½"

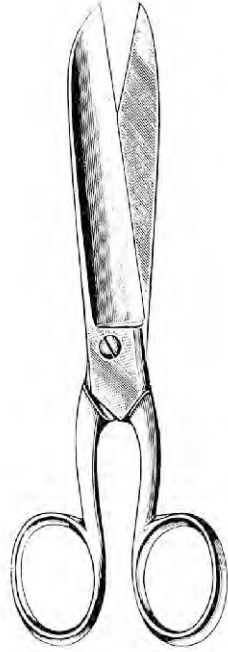


Ai 15-3813-13
13 cm/5"





Maier
 Ai 15-3814-15
 15 cm/6"



Schweizer
 Ai 15-3815-18
 18 cm/7"



Ai 15-3816-23
 23 cm/9"



Collin
 Ai 15-3817-22
 22 cm/8¾"



Gluck
 Ai 15-3818-22
 22 cm/8¾"



Stille
 Ai 15-3819-21
 21 cm/8¼"



Utility
 Ai 15-3820-15 15.0cm
 Ai 15-3820-18 18.0cm
 Available in all colors





Bergmann
 Ai 15-3821-18
 18 cm/7"



Engel
 Ai 15-3822-14
 14 cm/5 1/2"

Plaster of paris knives and saws



Hopkins
 Ai 15-3823-20
 20 cm/8"



Esmarch
 Ai 15-3824-18
 18 cm/7"



Reiner
 Ai 15-3825-18
 18 cm/7"



Ai 15-3826-21
 21 cm/8 1/2"



Wigmore
 Ai 15-3827-19
 19 cm/7 1/2"





Ai 15-3828-20 20.0cm



Seutin
 Ai 15-3829-23 23.0cm



Bruns
 Ai 15-3830-24 24.0cm



Bruns (serrated)
 Ai 15-3831-24 24.0cm



Stille-Mini
 Ai 15-3832-20 20.0cm



Stille
 Ai 15-3833-20 20.0cm
 Ai 15-3833-23 23.0cm
 Ai 15-3833-26 26.0cm
 Ai 15-3833-30 30.0cm
 Ai 15-3833-37 37.0cm



Stille
 Ai 15-3834-24 24.0cm



Haglund-Stille
 Ai 15-3835-28
 28 cm/11"



USA Mod Spreader
 Ai 15-3836-23
 23 cm/9"



Wolff-Boehler
 Ai 15-3837-18 18 cm/7"
 Ai 15-3837-20 20 cm/8"
 Ai 15-3837-22 22 cm/8½"
 Ai 15-3837-24 24 cm/9½"
 Ai 15-3837-26 26 cm/10½"



Hennig
 Ai 15-3838-28
 28 cm/11"

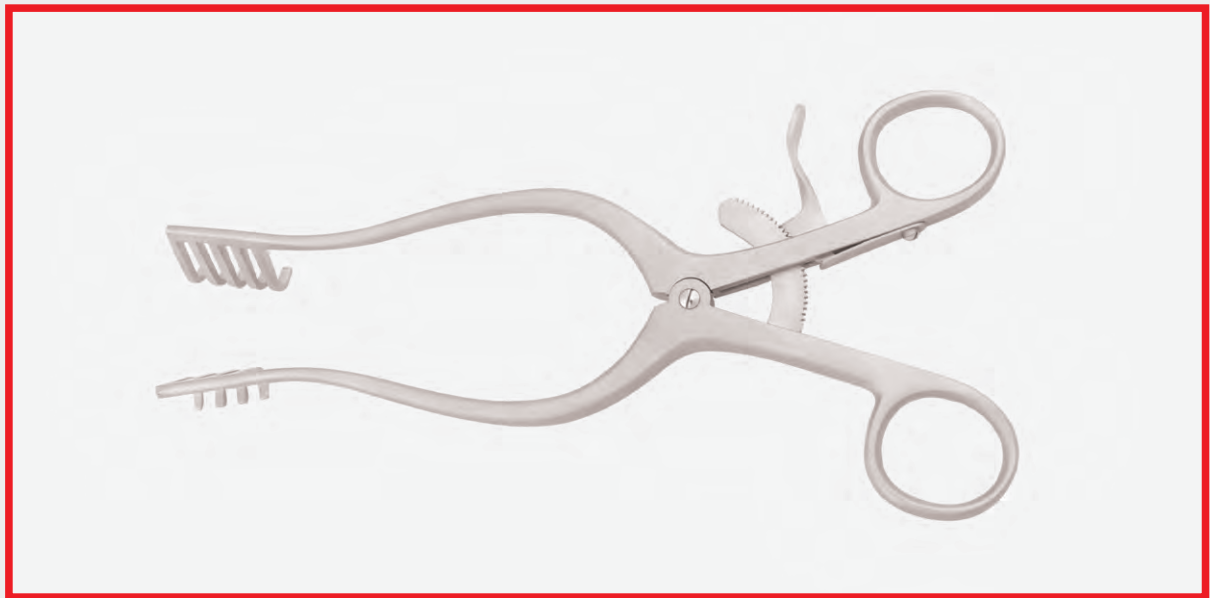


Beeson
 Ai 15-3839-30
 30 cm/12"



- EN** Retractors
- DE** Wundhaken und -sperrer
- ES** Separadores

Page 275 to 345

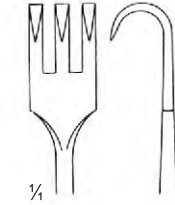




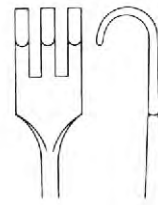
RAGNELL-DAVIS
 Ai 16-4201-14
 14 cm/5 1/2"



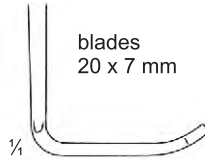
SENN-MILLER
 16 cm/6 1/4"



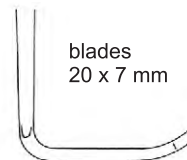
Ai 16-4202-16
 sharp prongs



Ai 16-4203-16
 blunt prongs



blades
 20 x 7 mm



blades
 20 x 7 mm



CUSHING
 Ai 16-4204-20
 20 cm/7 7/8"



CUSHING



20 cm/7 7/8"
 24 cm/9 1/2"

Ai 16-4205-20
 Ai 16-4208-24
 8 mm



Ai 16-4206-20
 Ai 16-4209-24
 10 mm



Ai 16-4207-20
 Ai 16-4210-20
 12 mm



20 cm/7 7/8"
 24 cm/9 1/2"

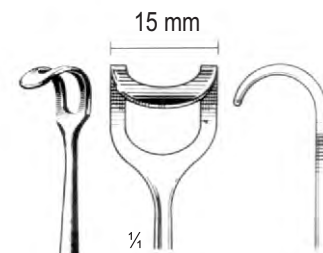
Ai 16-4211-20
 Ai 16-4214-24
 14 mm



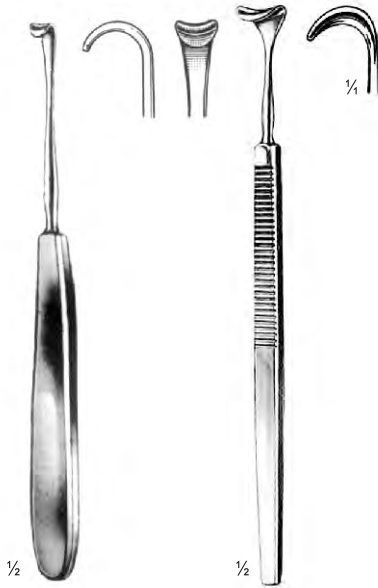
Ai 16-4212-20
 Ai 16-4215-24
 16 mm



Ai 16-4213-20
 Ai 16-4216-24
 18 mm

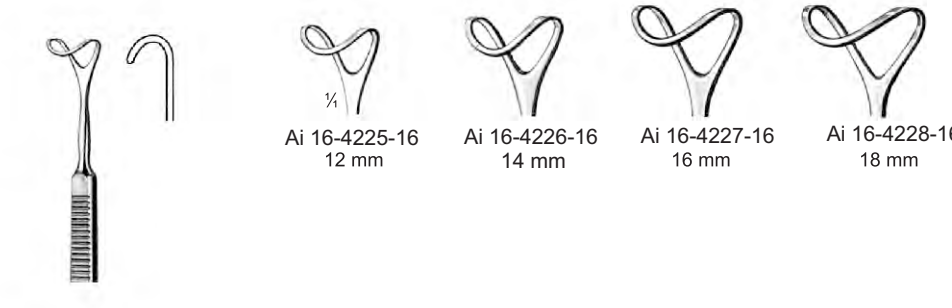
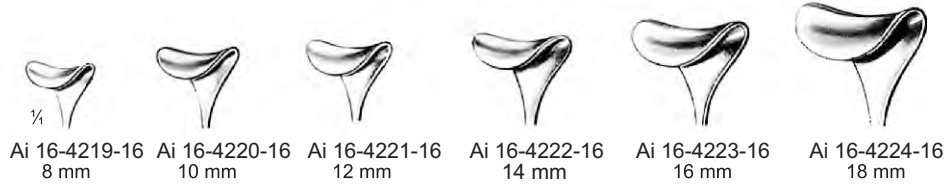


HANDTE
 Ai 16-4217-17
 17 cm/6 3/4"



DESMARRES
 Ai 16-4218-16
 16 cm/6 1/4"

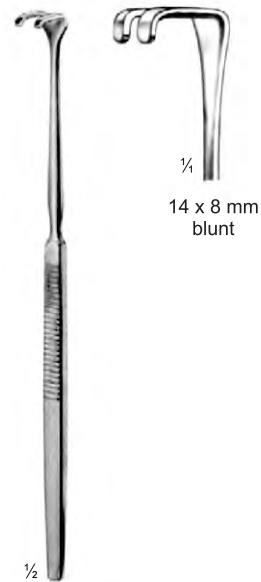
DESMARRES
 16 cm/6 1/4"



16 cm/6 1/4"



MINI-LANGENBECK
 16 cm/6 1/4"



MINI-LANGENBECK
 Ai 16-4233-16
 16 cm/6 1/4"





MEYERDUNG
18 cm/7 1/8"



Ai 16-4234-18
18 x 7 mm



Ai 16-4235-18
16 x 5 mm



Ai 16-4236-18
7 x 4 mm



Ai 16-4237-18
10 x 3 mm



Ai 16-4238-18
7 x 4 mm



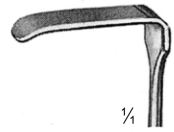
Ai 16-4239-18
10 x 4 mm



SENN-GREEN
15 cm/5 7/8"



10 x 6 mm
Ai 16-4240-15



20 x 6 mm
Ai 16-4241-15

28 x 6 mm



LAHEY
Ai 16-4242-19
19 cm/7 1/2"

12 x 14 mm



LITTLE
Ai 16-4243-20
20 cm/7 7/8"



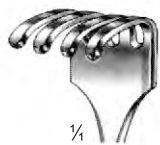
KLAPP
17.5 cm/6 7/8"



Ai 16-4244-17
13 x 6 mm



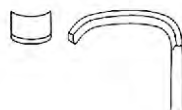
Ai 16-4245-17
12 x 11 mm



Ai 16-4246-17
15 x 12 mm



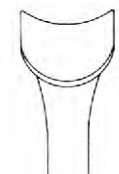
STRANDELL-STILLE
19 cm/7 1/2"



Ai 16-4247-19



Ai 16-4248-19
toothed



19 x 12 mm
Ai 16-4249-19



21 x 14 mm
Ai 16-4250-19

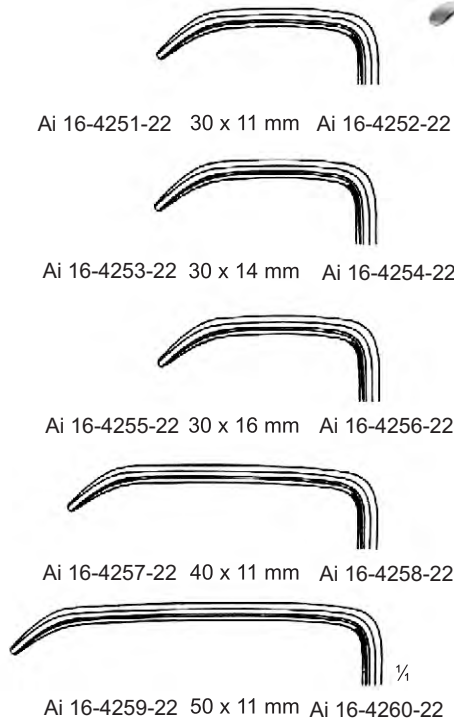


KOCHER
19 cm/7 1/2"

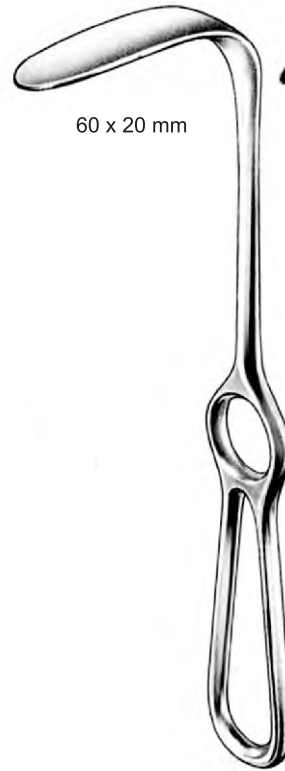




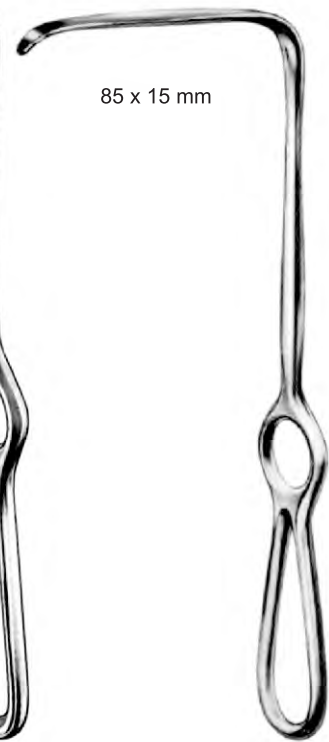
LANGENBECK
 22 cm/8 1/2"



LANGENBECK
 21 cm/8 1/4"



LANGENBECK
 Ai 16-4261-21
 21 cm/8 1/4"



LANGENBECK
 Ai 16-4262-21
 21 cm/8 1/4"

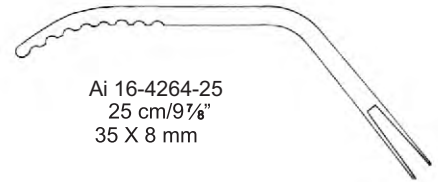




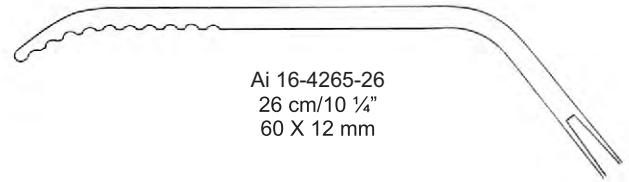
ZENKER



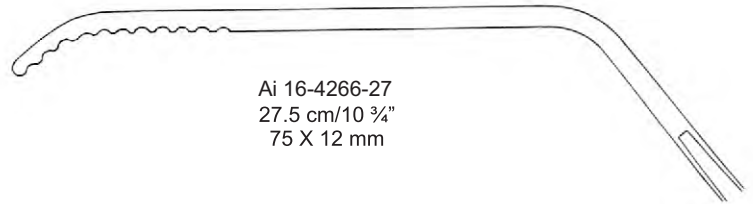
MINI-ZENKER
 Ai 16-4263-18
 18 cm/7 1/8"
 10 X 3 mm



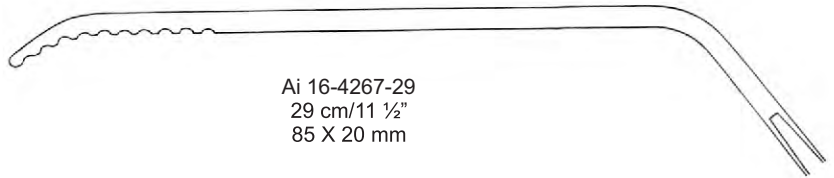
Ai 16-4264-25
 25 cm/9 7/8"
 35 X 8 mm



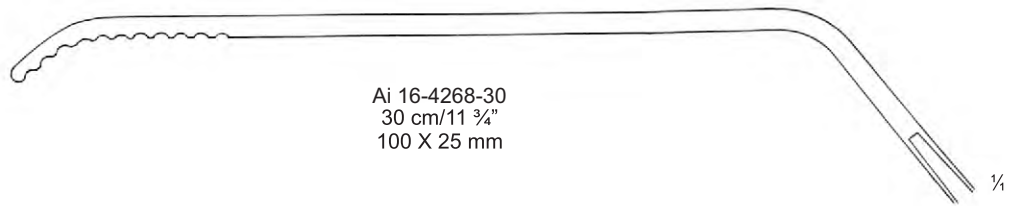
Ai 16-4265-26
 26 cm/10 1/4"
 60 X 12 mm



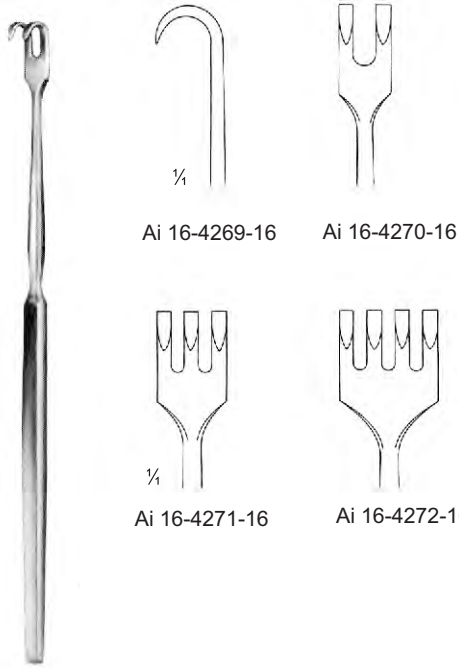
Ai 16-4266-27
 27.5 cm/10 3/4"
 75 X 12 mm



Ai 16-4267-29
 29 cm/11 1/2"
 85 X 20 mm

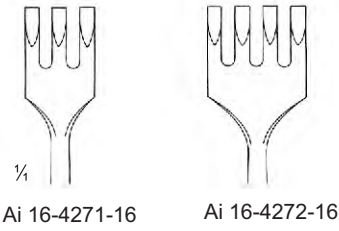


Ai 16-4268-30
 30 cm/11 3/4"
 100 X 25 mm



Ai 16-4269-16

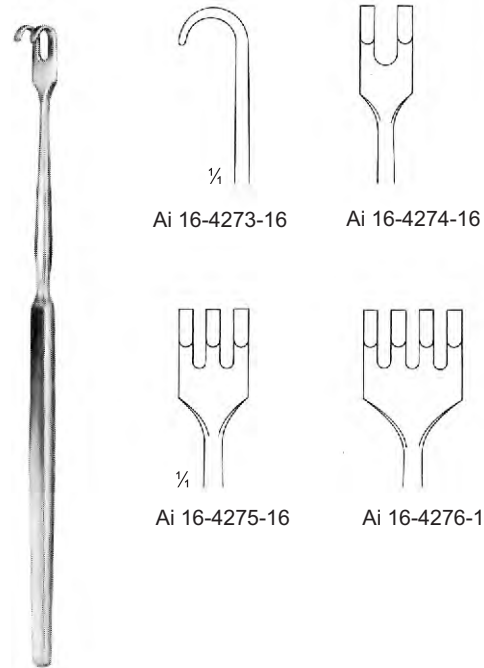
Ai 16-4270-16



Ai 16-4271-16

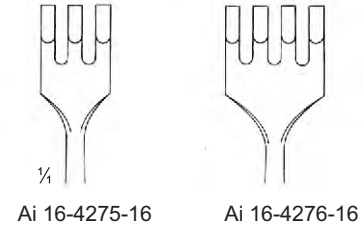
Ai 16-4272-16

TRACHEAL
 16 cm/6 1/4"
 sharp



Ai 16-4273-16

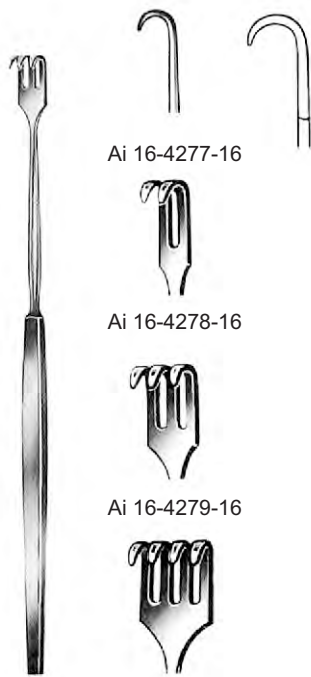
Ai 16-4274-16



Ai 16-4275-16

Ai 16-4276-16

TRACHEAL
 16 cm/6 1/4"
 blunt



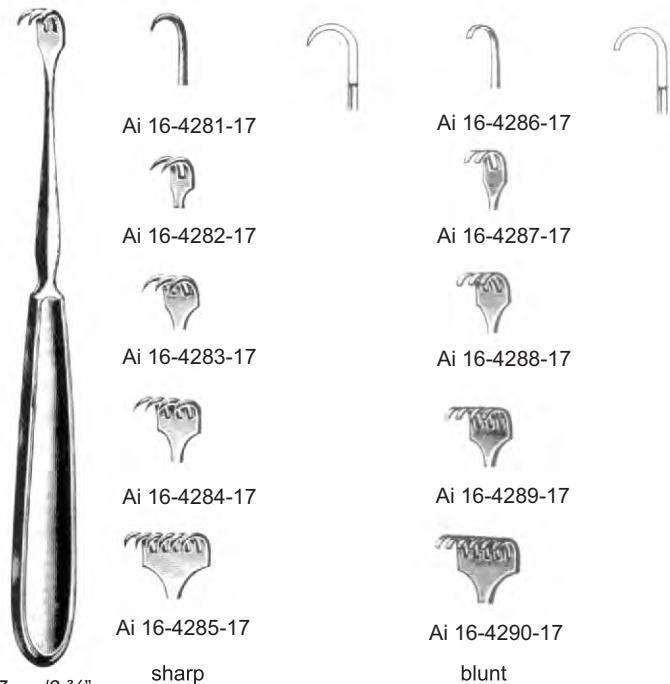
Ai 16-4277-16

Ai 16-4278-16

Ai 16-4279-16

Ai 16-4280-16

TRACHEAL
 16 cm/6 1/4"
 semi-sharp



Ai 16-4281-17

Ai 16-4286-17

Ai 16-4282-17

Ai 16-4287-17

Ai 16-4283-17

Ai 16-4288-17

Ai 16-4284-17

Ai 16-4289-17

Ai 16-4285-17

Ai 16-4290-17

17 cm/6 3/4"

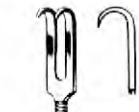
sharp

blunt





16 cm/6 1/4"
flexible



Ai 16-4291-16



Ai 16-4292-16



Ai 16-4293-16



Ai 16-4294-16



Ai 16-4295-16
sharp



Ai 16-4296-16
blunt



16 cm/6 1/4"



Ai 16-4297-16
sharp



Ai 16-4298-16
blunt



VESSEL HOOK
 Ai 16-4299-12
 12 cm/4 3/4"



VOLKMANN
 11.5 cm/4 1/2"



Ai 16-4300-11



Ai 16-4301-11



Ai 16-4302-11



Ai 16-4303-11



Ai 16-4304-11



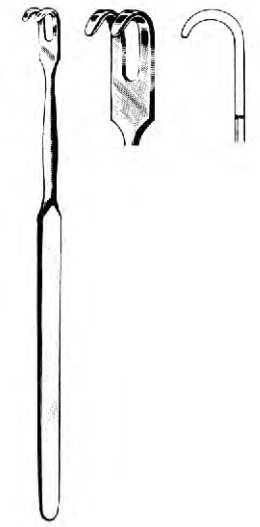
Ai 16-4305-11



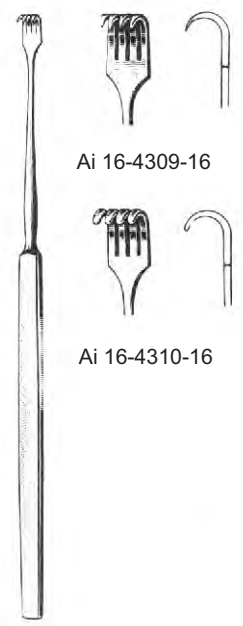
Ai 16-4306-11



Ai 16-4307-11



Ai 16-4308-13
 13.5 cm/5 3/8"

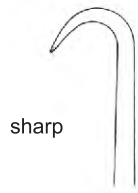


16 cm/6 1/4"

Ai 16-4309-16

Ai 16-4310-16

Measurements of retractors: Depth x Width



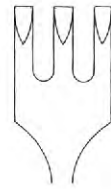
sharp

Ai 16-4311-21

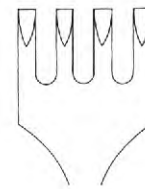


¼

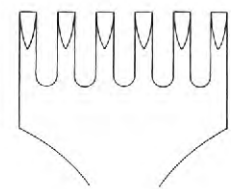
Ai 16-4312-21



Ai 16-4313-21



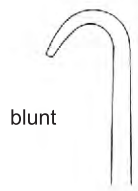
Ai 16-4314-21



Ai 16-4315-21



VOLKMANN
 21.5 cm/8 ½"



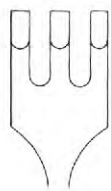
blunt

Ai 16-4316-21

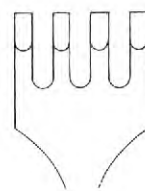


¼

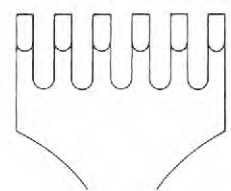
Ai 16-4317-21



Ai 16-4318-21



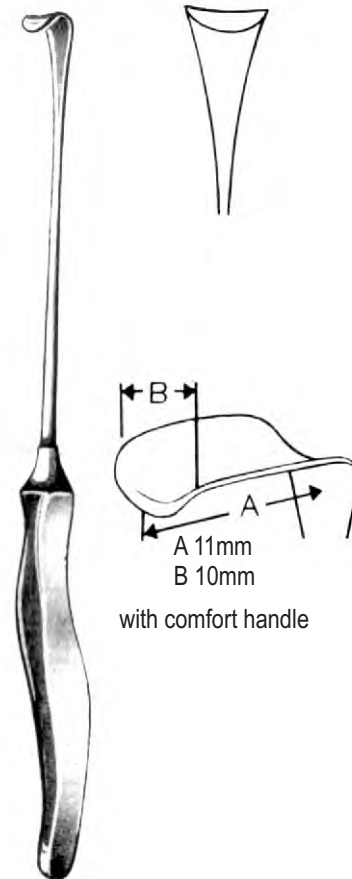
Ai 16-4319-21



Ai 16-4320-21



CUSHING
 Ai 16-4321-21
 21.5 cm/8 ½"
 Ai 16-4322-21



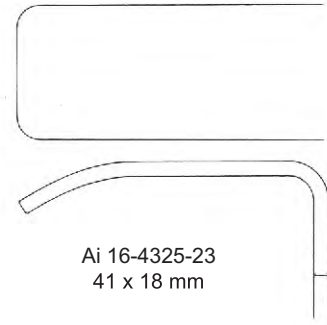
A 11mm
 B 10mm
 with comfort handle

CUSHING
 Ai 16-4323-21
 24.5 cm/9 ⅝"
 Ai 16-4324-21

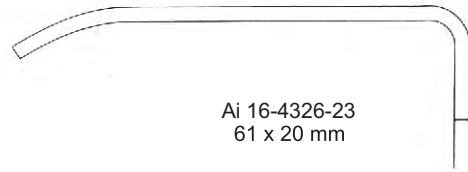




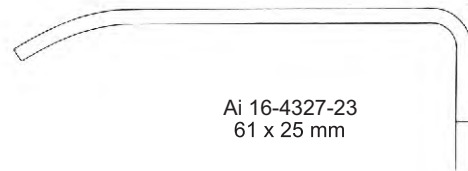
KOCHER
23 cm/9"



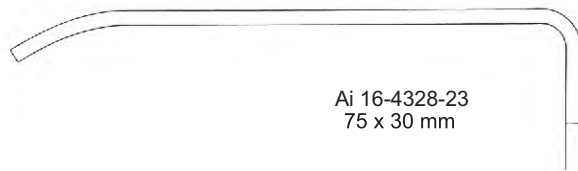
Ai 16-4325-23
41 x 18 mm



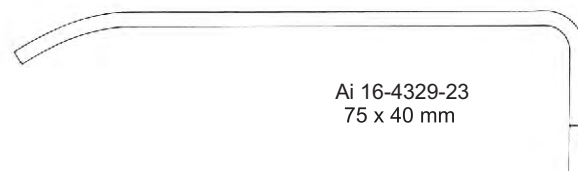
Ai 16-4326-23
61 x 20 mm



Ai 16-4327-23
61 x 25 mm



Ai 16-4328-23
75 x 30 mm

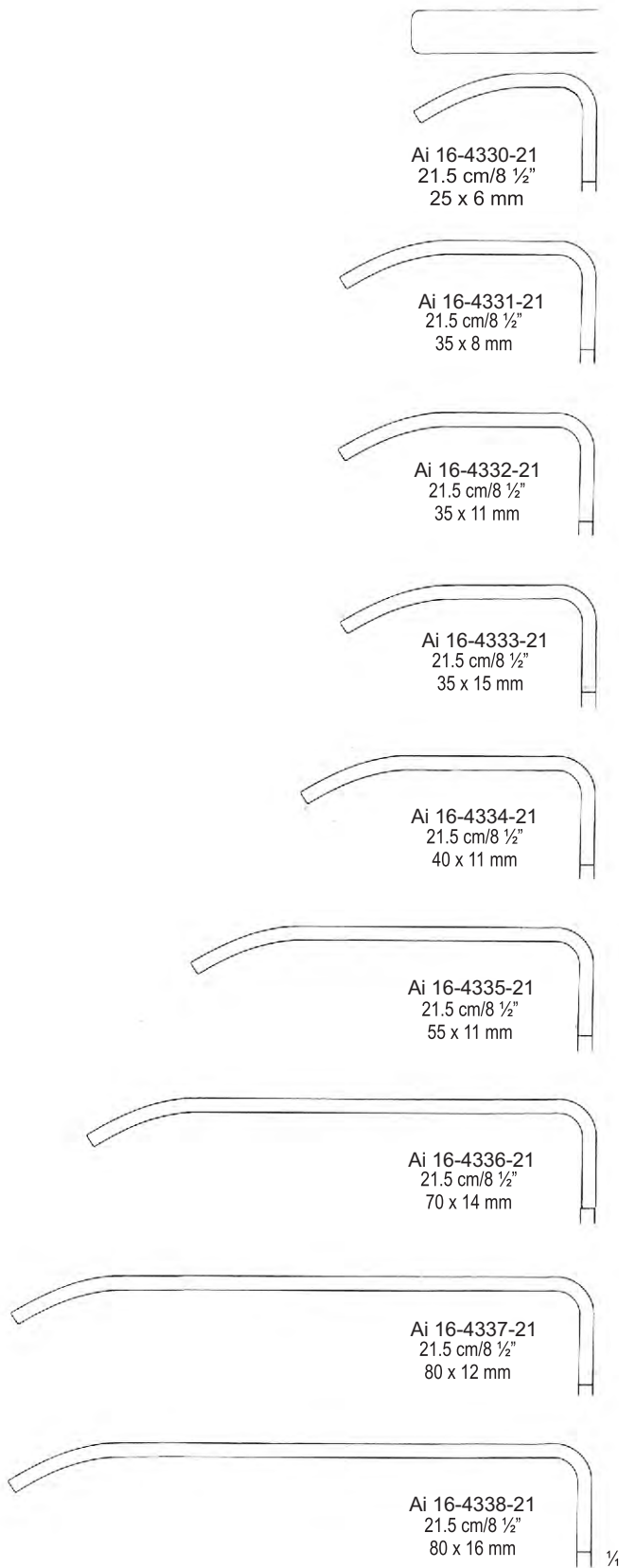


Ai 16-4329-23
75 x 40 mm

1/4



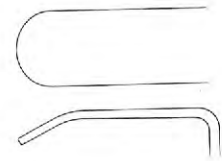
KOCHER-LANGENBECK
 21.5 cm/8 1/2"



Measurements of retractors: Depth x Width



KOCHER-LANGENBECK
21.5 cm/8 1/2"



Ai 16-4339-21
21.5 cm/8 1/2"
25 x 10 mm



Ai 16-4340-21
21.5 cm/8 1/2"
40 x 13 mm



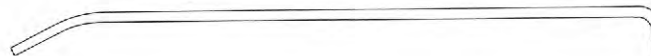
Ai 16-4341-21
21.5 cm/8 1/2"
60 x 13 mm



Ai 16-4342-21
21.5 cm/8 1/2"
40 x 18 mm



Ai 16-4343-21
21.5 cm/8 1/2"
60 x 18 mm



Ai 16-4344-21
21.5 cm/8 1/2"
85 x 18 mm



Ai 16-4345-21
21.5 cm/8 1/2"
60 x 25 mm

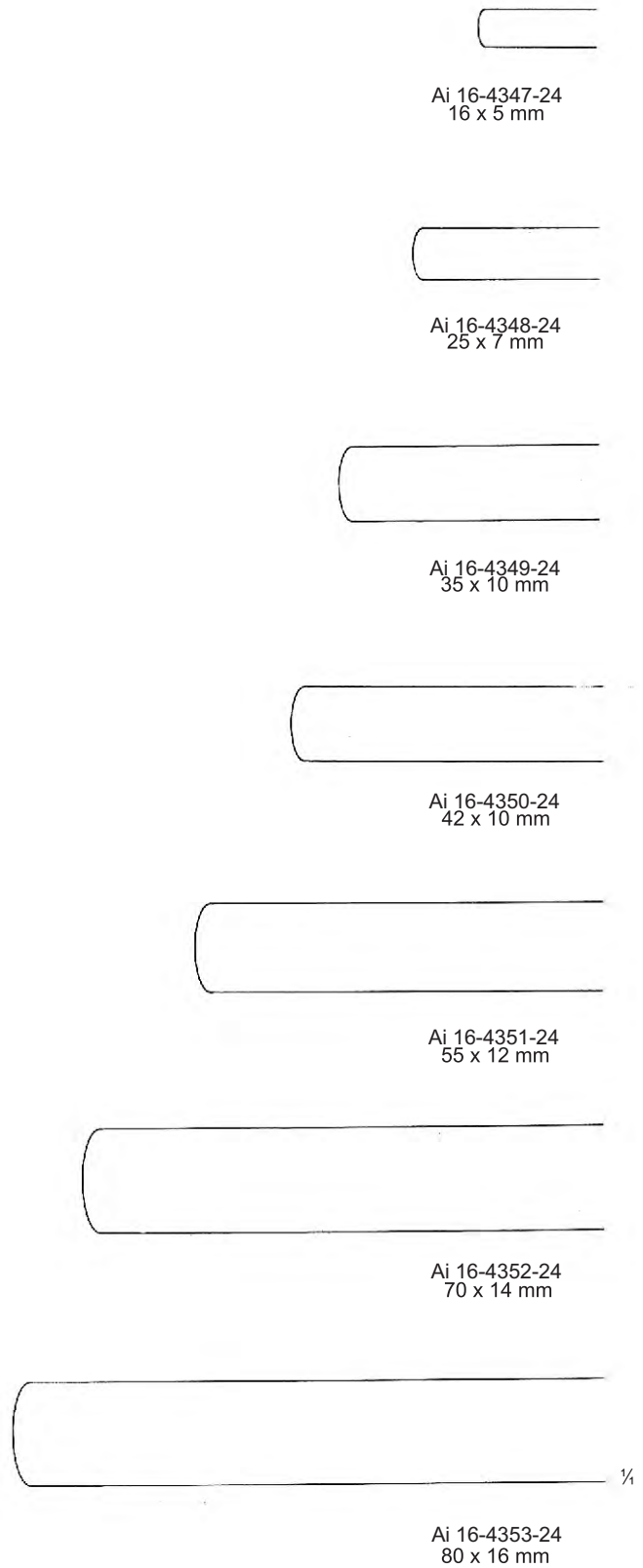


Ai 16-4346-21
21.5 cm/8 1/2"
85 x 25 mm

Measurements of retractors: Depth x Width



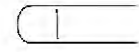
OBWEGESER
 24 cm/9 1/2"
 bent downwards



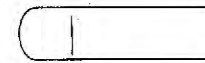
Measurements of retractors: Depth x Width



OBWEGESER
 24cm/9 1/2"
 bent upward



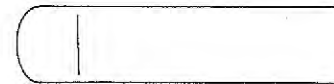
Ai 16-4354-24
 16 x 5 mm



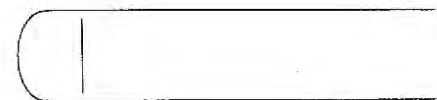
Ai 16-4355-24
 25 x 7 mm



Ai 16-4356-24
 35 x 10 mm



Ai 16-4357-24
 42 x 10 mm



Ai 16-4358-24
 55 x 12 mm

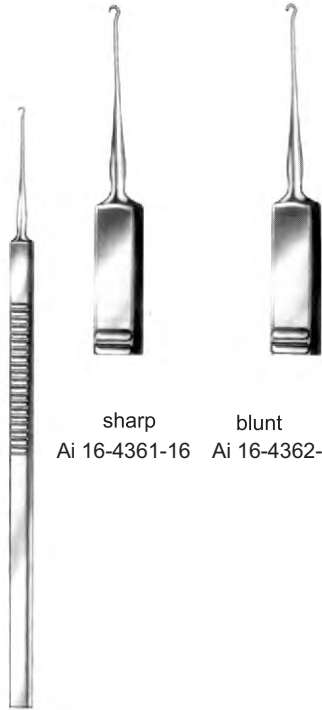


Ai 16-4359-24
 70 x 14 mm



Ai 16-4360-24
 80 x 16 mm

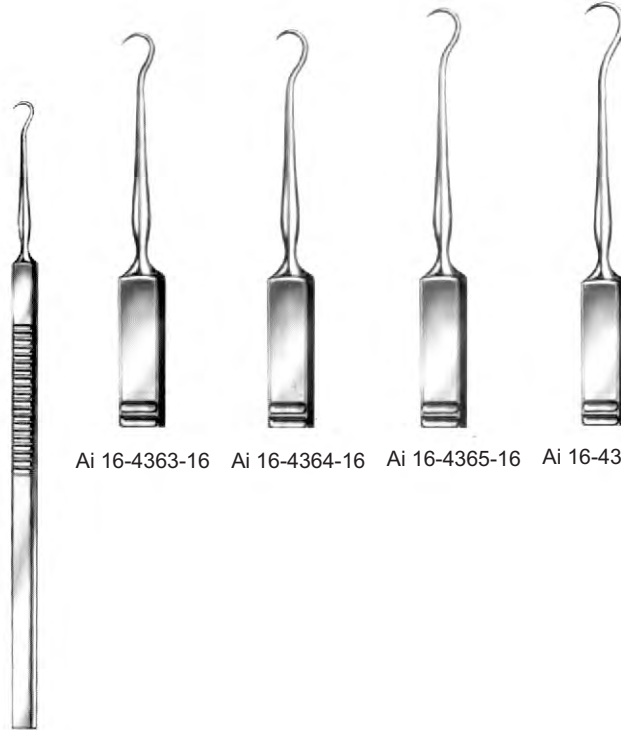
Measurements of retractors: Depth x Width



sharp
Ai 16-4361-16

blunt
Ai 16-4362-16

GRAEFE
16 cm/6 1/4"

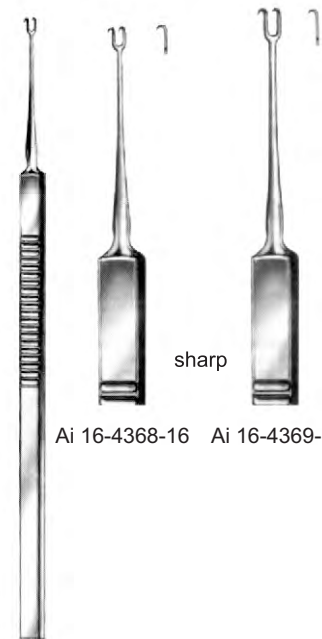


Ai 16-4363-16 Ai 16-4364-16 Ai 16-4365-16 Ai 16-4366-16

GRAEFE
16 cm/6 1/4"

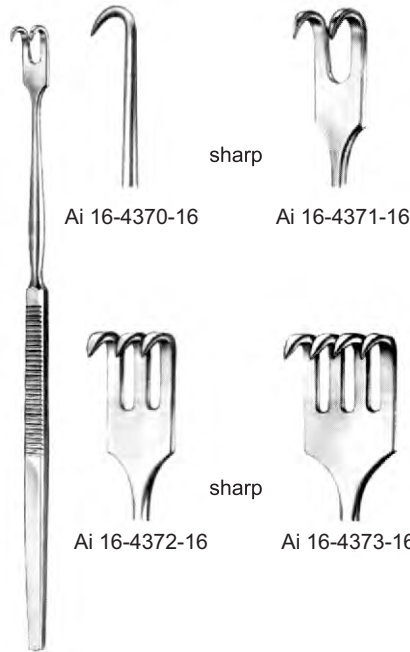


O'CONNOR
Ai 16-4367-16
16 cm/6 1/4"



sharp
Ai 16-4368-16 Ai 16-4369-16

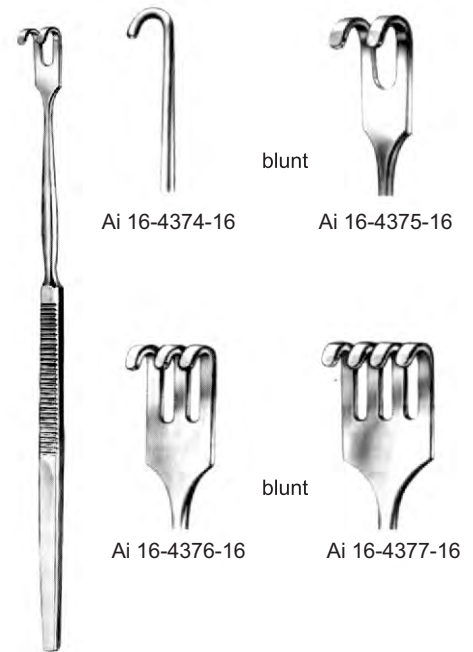
GUTHRIE
16 cm/6 1/4"



sharp
Ai 16-4370-16 Ai 16-4371-16

sharp
Ai 16-4372-16 Ai 16-4373-16

KEHLENGRIFF
16 cm/6 1/4"



blunt
Ai 16-4374-16 Ai 16-4375-16

blunt
Ai 16-4376-16 Ai 16-4377-16

KEHLENGRIFF
16 cm/6 1/4"

Measurements of retractors: Depth x Width



16 x 5 mm



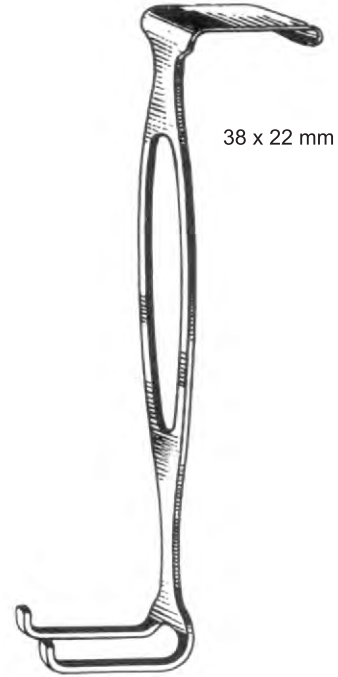
CANNY RYALL
 Ai 16-4378-15 15mm
 Ai 16-4378-20 20mm
 Ai 16-4378-25 25mm
 Ai 16-4378-30 30mm



CANNY RYALL
 Ai 16-4379-17 17 cm/6 3/4"



CANNY RYALL
 Ai 16-4380-17 17 cm/6 3/4"



38 x 22 mm

CZERNEY
 Ai 16-4381-17 17 cm/6 3/4"



Ai 16-4382-23



Ai 16-4383-23

Sharp



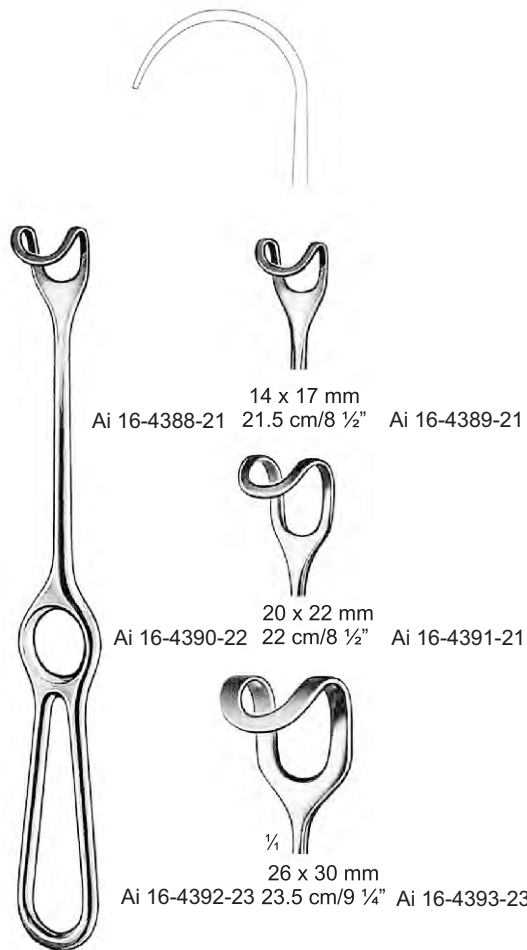
Ai 16-4384-23



23 cm/9"



KOCHER
 22 cm/8 1/2"
 Ai 16-4385-22 40 x 10 mm
 Ai 16-4386-22 40 x 15 mm
 Ai 16-4387-22 40 x 20 mm



MIDDELDORPF

14 x 17 mm
 Ai 16-4388-21 21.5 cm/8 1/2" Ai 16-4389-21

20 x 22 mm
 Ai 16-4390-22 22 cm/8 1/2" Ai 16-4391-21

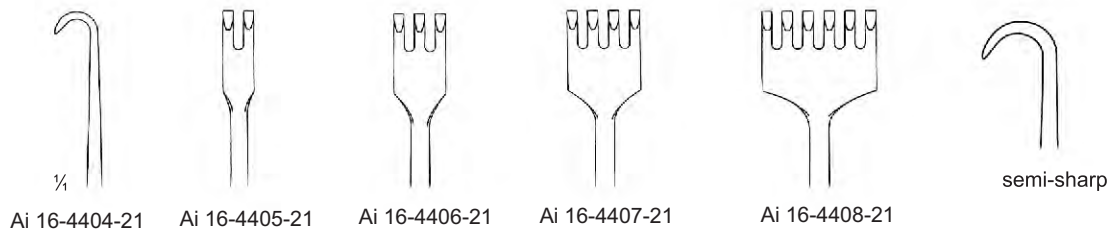
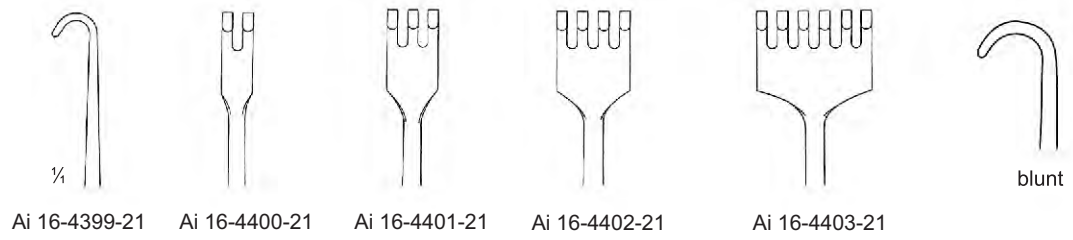
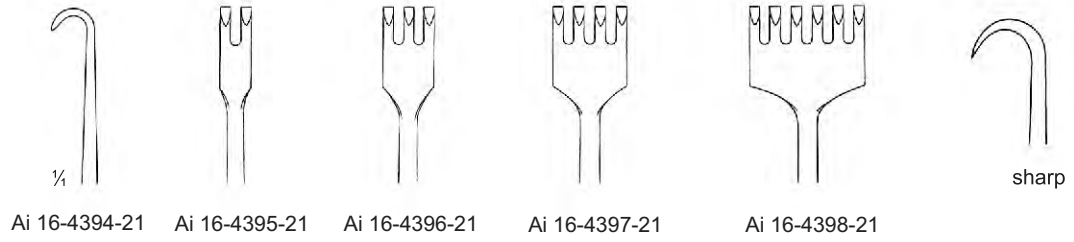
1/4
 26 x 30 mm
 Ai 16-4392-23 23.5 cm/9 1/4" Ai 16-4393-23



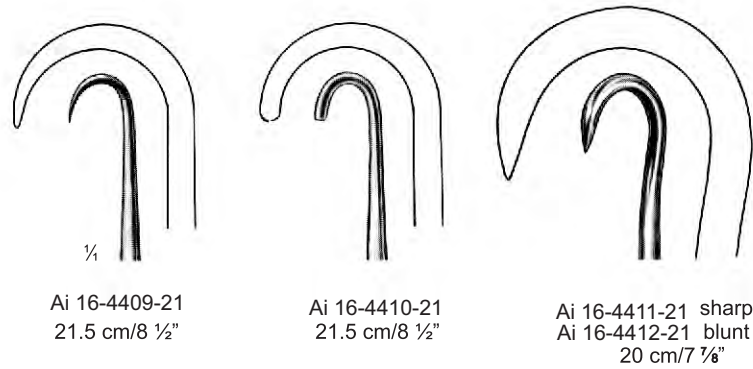
MIDDELDORPF



Measurements of retractors: Depth x Width



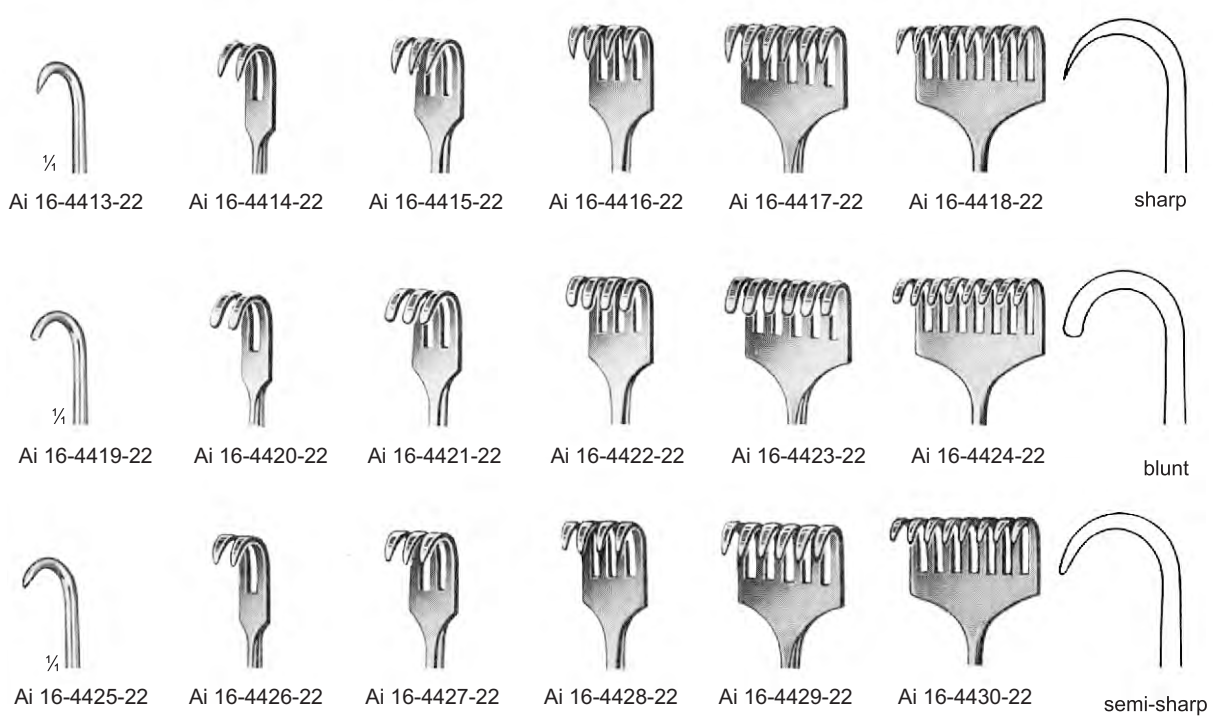
VOLKMANN
 21.5 cm/8 1/2"



Measurements of retractors: Depth x Width



KOCHER
 22 cm/8 1/2"



Ai 16-4431-22

OLLIER
 Ai 16-4432-22
 22.5 cm/8 3/4"



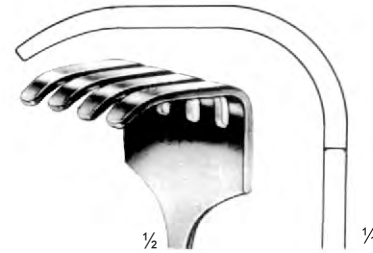
WASSMUND
 Ai 16-4433-20
 20 cm/7 7/8"

Measurements of retractors: Depth x Width





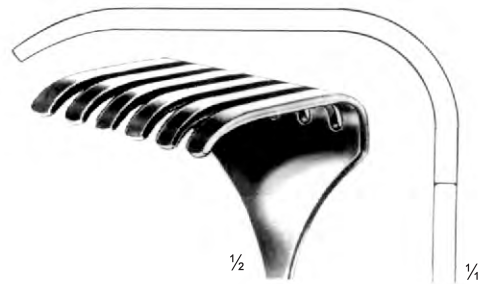
Ai 16-4434-27
 27 cm/10 1/2"



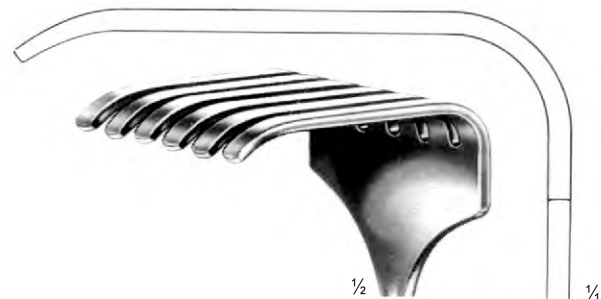
Ai 16-4435-25
 40 x 40 mm



Ai 16-4436-25
 45 x 50 mm



Ai 16-4437-25
 50 x 60 mm



Ai 16-4438-25
 70 x 70 mm



ISRAEL
 25 cm/9 7/8"

Measurements of retractors: Depth x Width

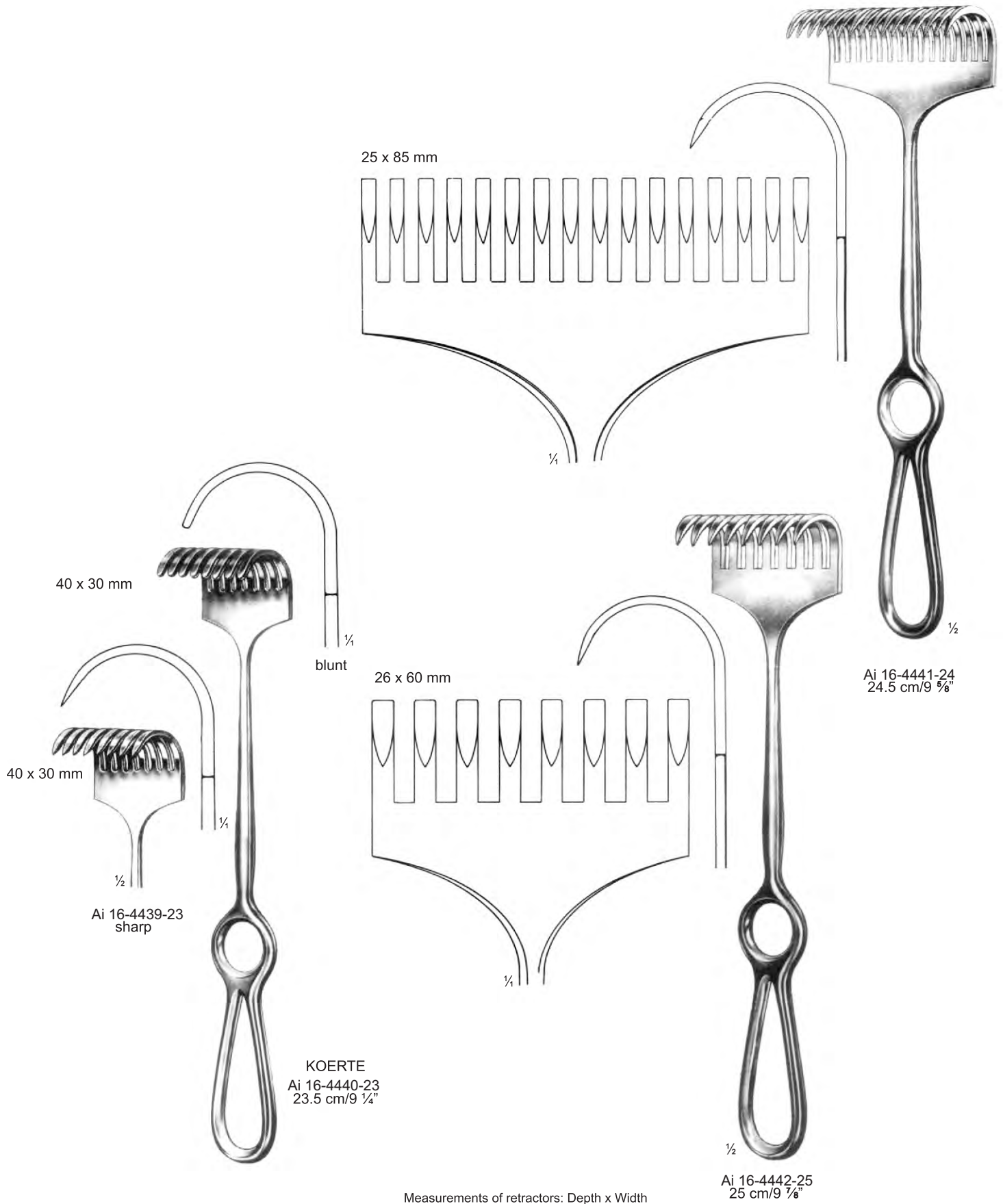




Fig. 1
 Ai 16-4443-26
 26 cm/10 1/4"
 25 x 20 mm
 30 x 28 mm

Fig. 2
 Ai 16-4444-27
 27.5 cm/10 3/4"
 43 x 38 mm
 63 x 44 mm

RICHARDSON-EASTMAN
 Ai 16-4445-1
 Set Fig. 1 + 2

RICHARDSON

RICHARDSON
 Ai 16-4448-24
 24 cm/9 1/2"

KELLY
 Ai 16-4449-26 62 x 50 mm
 Ai 16-4450-26 70 X 65 mm
 26 cm/10 1/4"

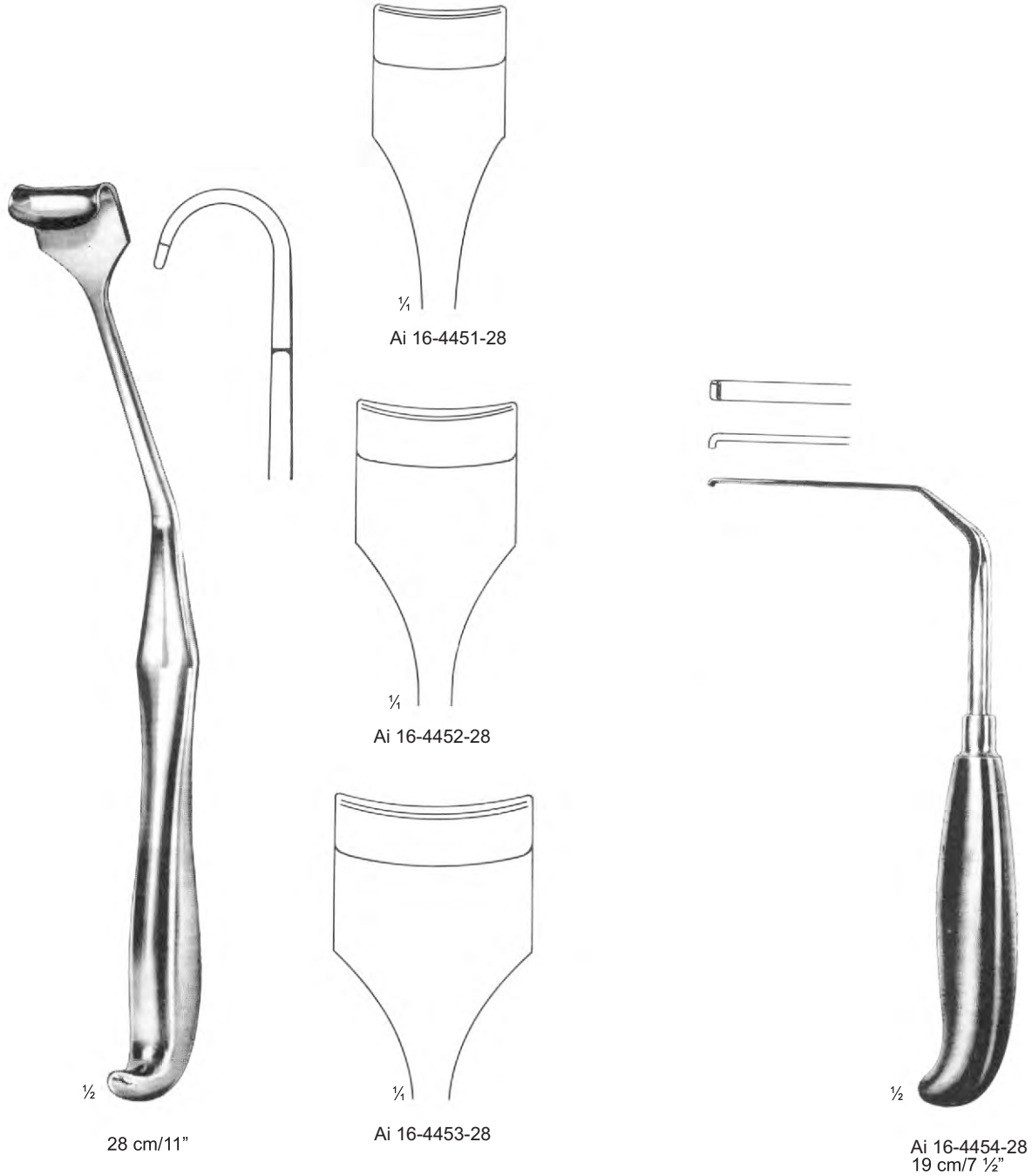
Ai 16-4446-23
 23.5 cm/9 1/4"
 25 x 21 mm

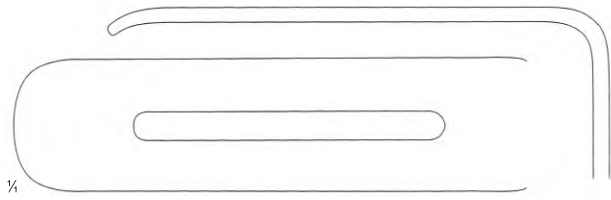
Ai 16-4446-24
 24 cm/9 1/2"
 30 x 29 mm

Ai 16-4447-24
 24 cm/9 1/2"
 38 x 40 mm

48 x 22 mm

1/4

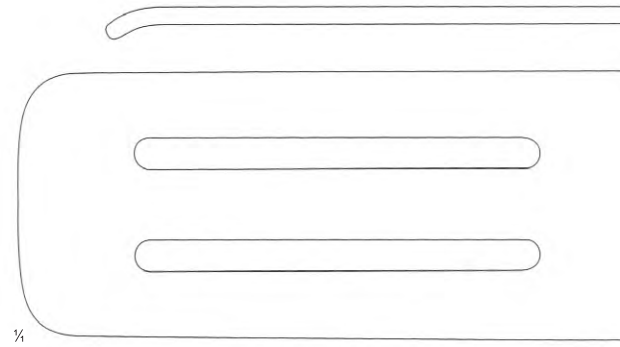




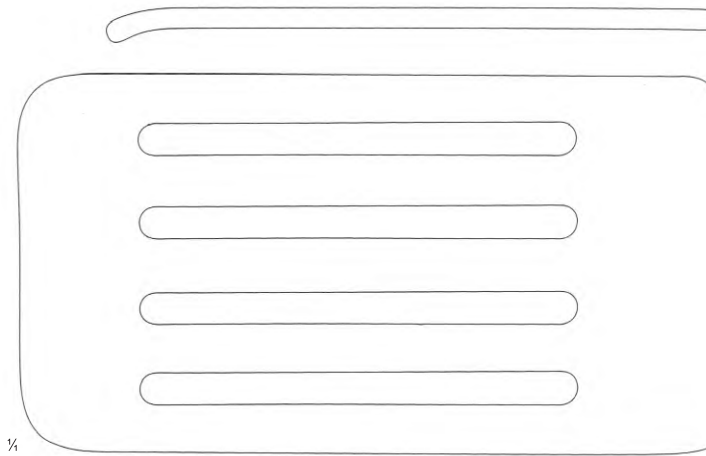
Ai 16-4455-23
23 x 85 mm



CORYLLOS
23 cm/9"



Ai 16-4456-23
44 x 105 mm

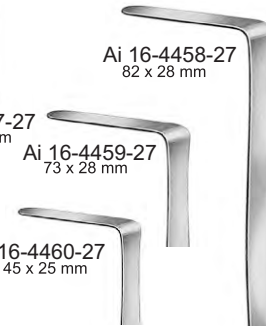


Ai 16-4457-27
65 x 115 mm

Ai 16-4459-27
73 x 28 mm

Ai 16-4460-27
45 x 25 mm

Ai 16-4458-27
82 x 28 mm



HEANEY
27 cm/10 1/2"



50 x 85 mm

½

DOYEN

Ai 16-4461-25
 25 cm/9 7/8"

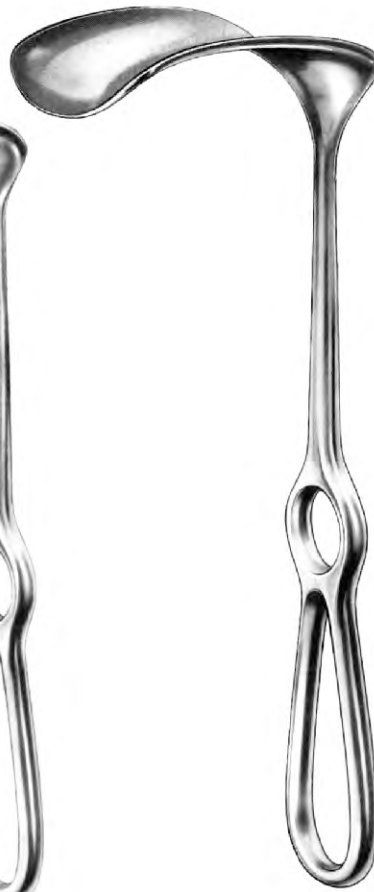


70 x 25 mm

½

KOCHER

Ai 16-4462-22
 22.5 cm/8 3/4"



KOCHER

	Total length	Blade
	cm in.	mm
Ai 16-4463-25	25 9 7/8"	80 x 45
Ai 16-4464-25	25 9 7/8"	80 x 55
Ai 16-4465-25	25 9 7/8"	80 x 65



TUFFIER

Ai 16-4466-21
 21.5 cm/8 1/2"



Measurements of retractors: Depth x width

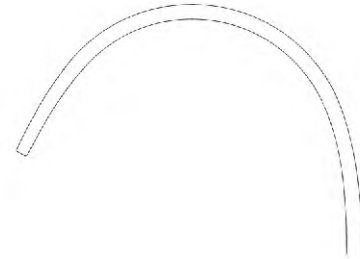


Ai 16-4467-25
 25 cm/9 7/8"
 87 x 28 mm

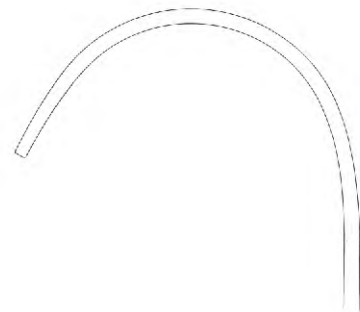
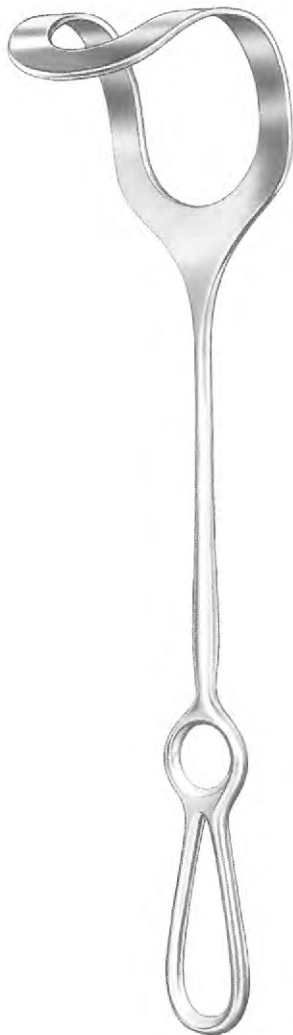
Ai 16-4468-25
 25 cm/9 7/8"
 97 x 31 mm

Ai 16-4469-25
 26 cm/10 1/4"
 117 x 52 mm

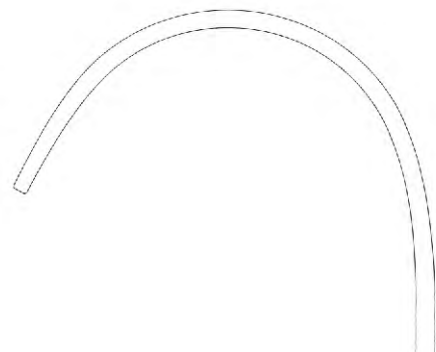
DOYEN-STILLE



Ai 16-4470-27
27 cm/10 1/2"
43 x 45 mm



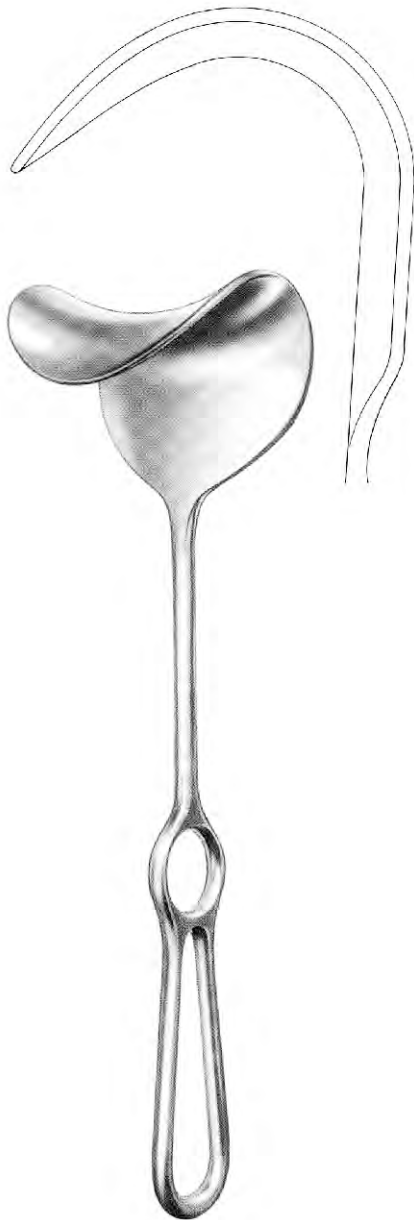
Ai 16-4471-27
27 cm/10 1/2"
52 x 50 mm



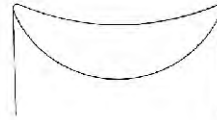
Ai 16-4471-28
28 cm/11"
52 x 70 mm

MIDDELDORPF

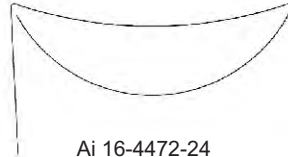




FRITSCH



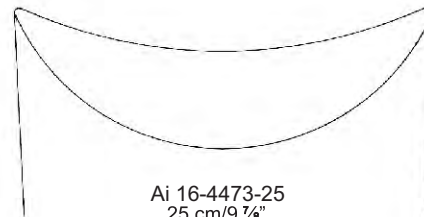
Ai 16-4472-23
 23.5 cm/9 1/4"
 37 x 31 mm



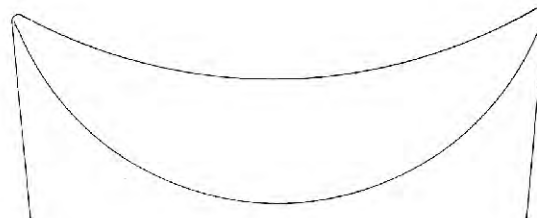
Ai 16-4472-24
 24 cm/9 1/2"
 38 x 40 mm



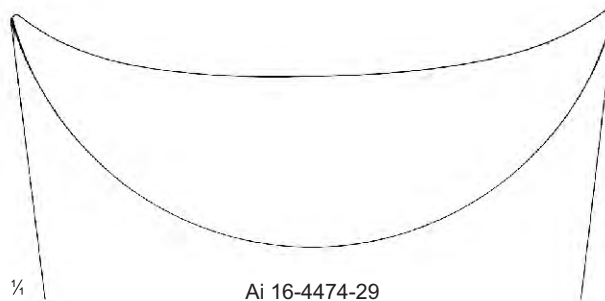
Ai 16-4472-25
 25 cm/9 7/8"
 43 x 51 mm



Ai 16-4473-25
 25 cm/9 7/8"
 49 x 61 mm



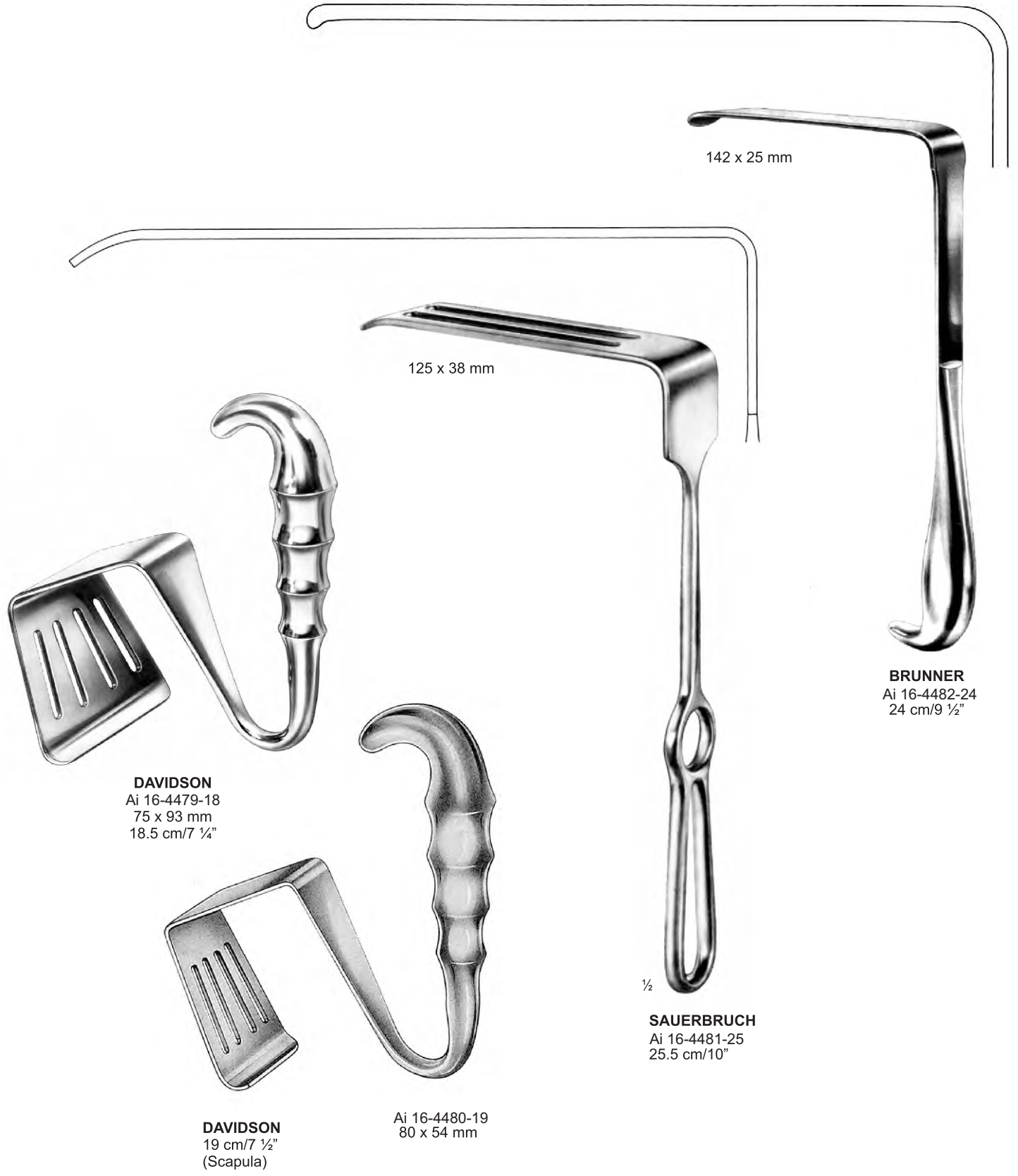
Ai 16-4474-25
 25.5 cm/10"
 48 x 75 mm



Ai 16-4474-29
 29.5 cm/11 3/4"
 65 x 85 mm



Measurements of retractors: Depth x width



142 x 25 mm

125 x 38 mm

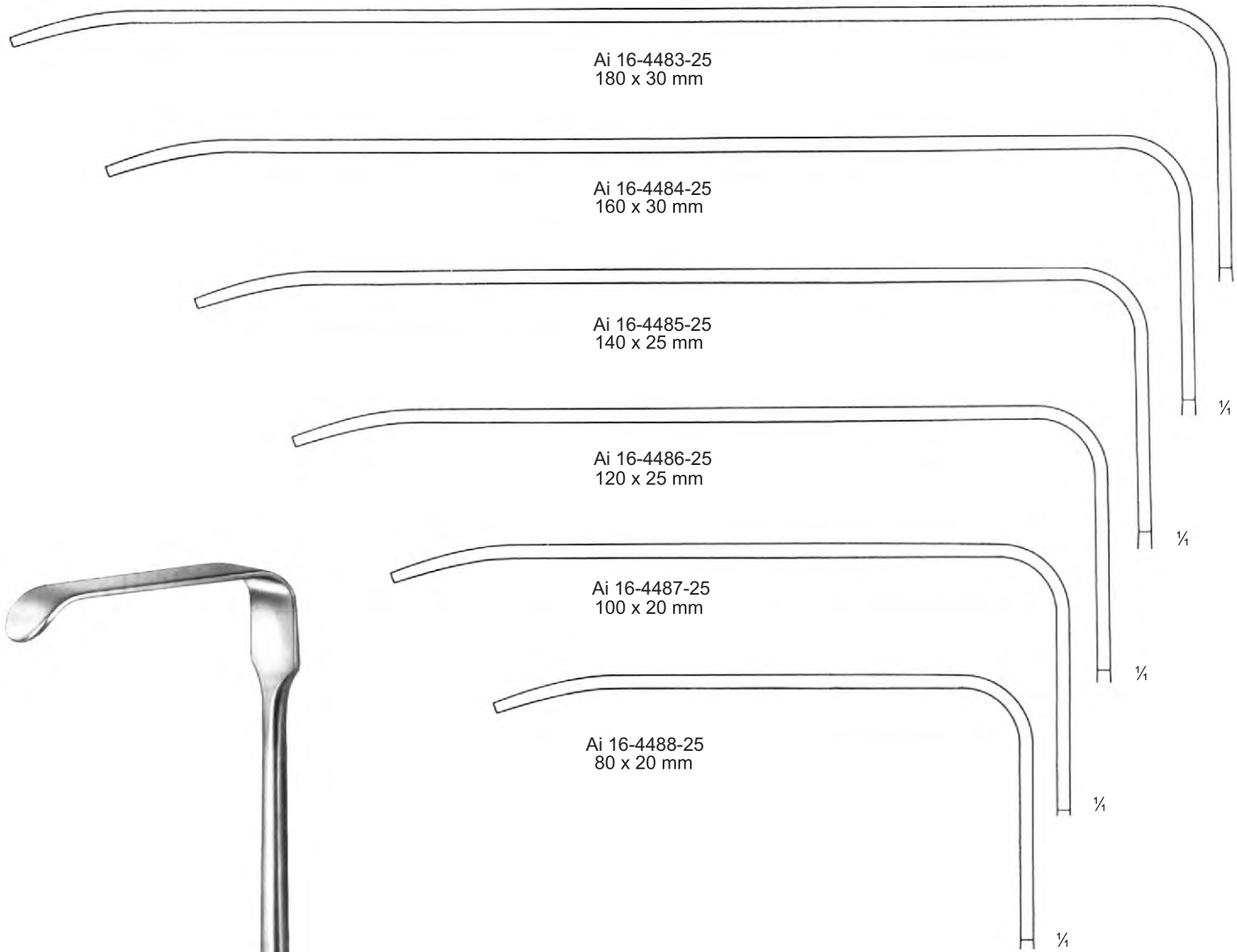
BRUNNER
 Ai 16-4482-24
 24 cm/9 1/2"

DAVIDSON
 Ai 16-4479-18
 75 x 93 mm
 18.5 cm/7 1/4"

DAVIDSON
 19 cm/7 1/2"
 (Scapula)

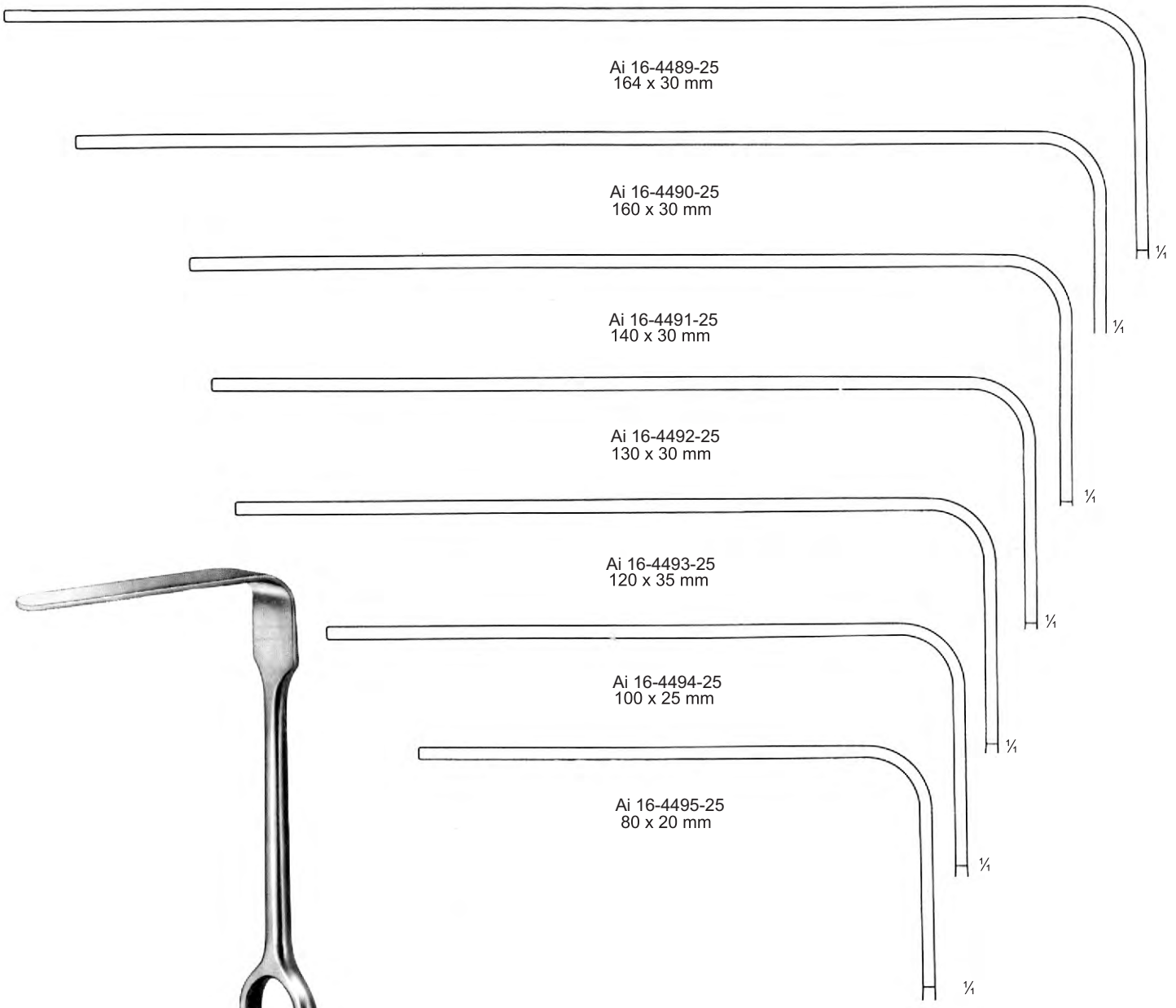
Ai 16-4480-19
 80 x 54 mm

1/2
SAUERBRUCH
 Ai 16-4481-25
 25.5 cm/10"



1/2

BRUNNER
 25 cm/9 7/8"



$\frac{1}{2}$
BRUNNER
 25.5 cm/10"

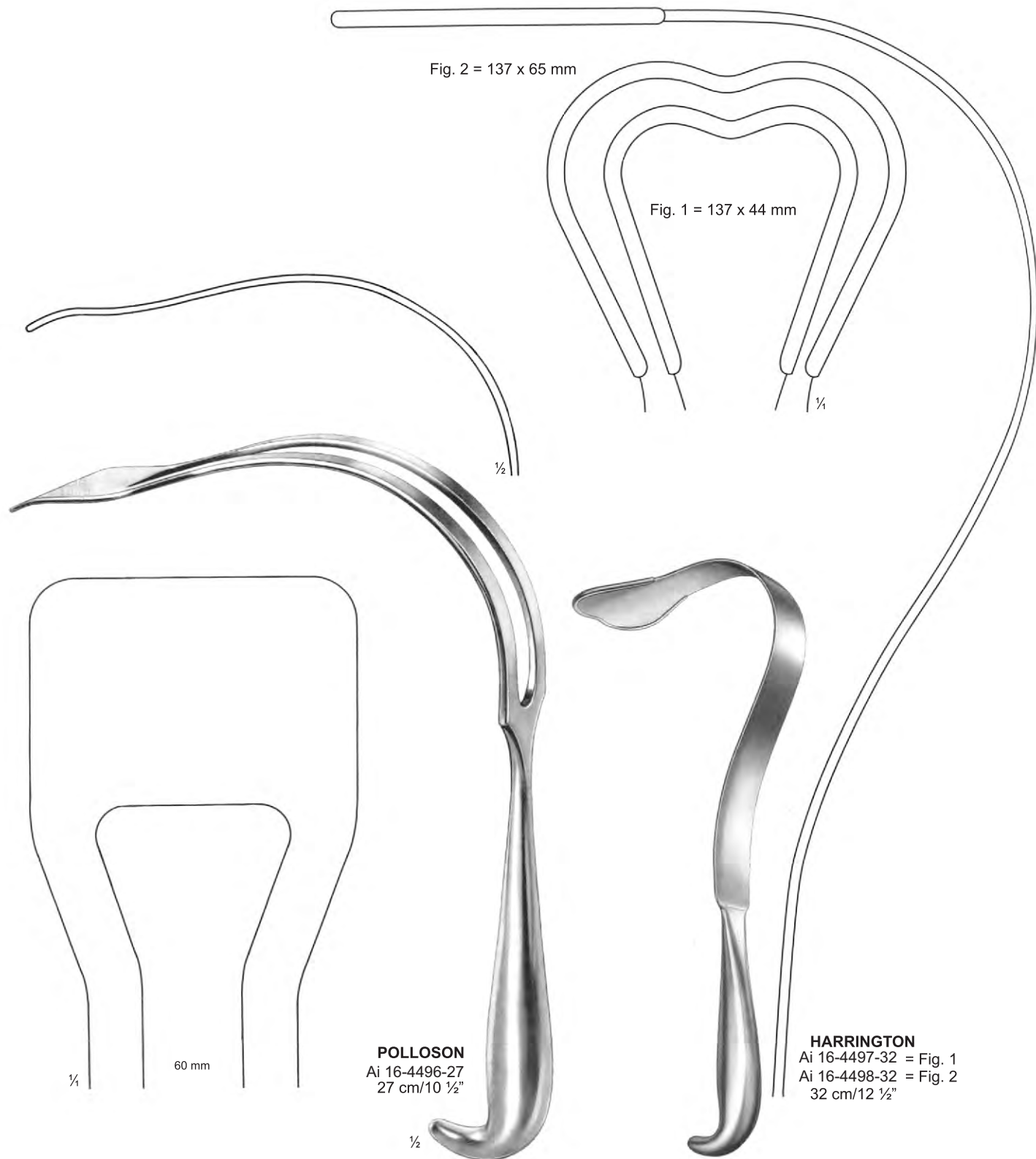
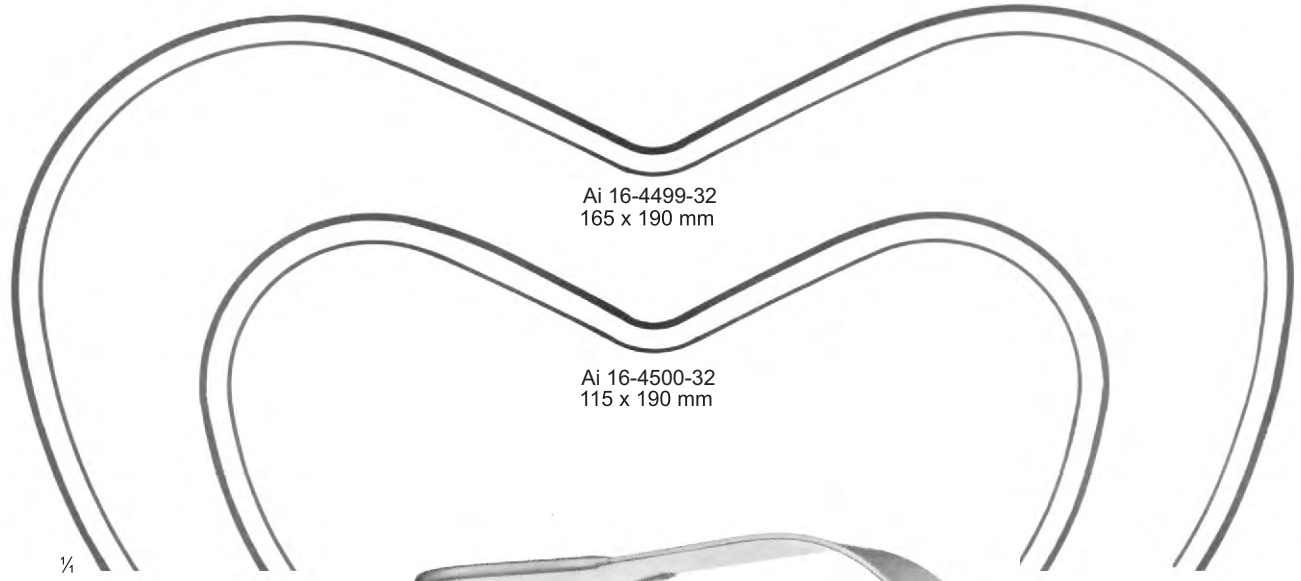


Fig. 2 = 137 x 65 mm

Fig. 1 = 137 x 44 mm

POLLOSON
 Ai 16-4496-27
 27 cm/10 1/2"

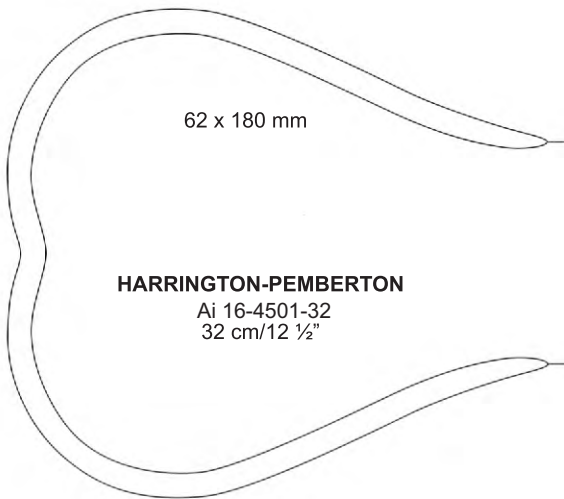
HARRINGTON
 Ai 16-4497-32 = Fig. 1
 Ai 16-4498-32 = Fig. 2
 32 cm/12 1/2"



Ai 16-4499-32
 165 x 190 mm

Ai 16-4500-32
 115 x 190 mm

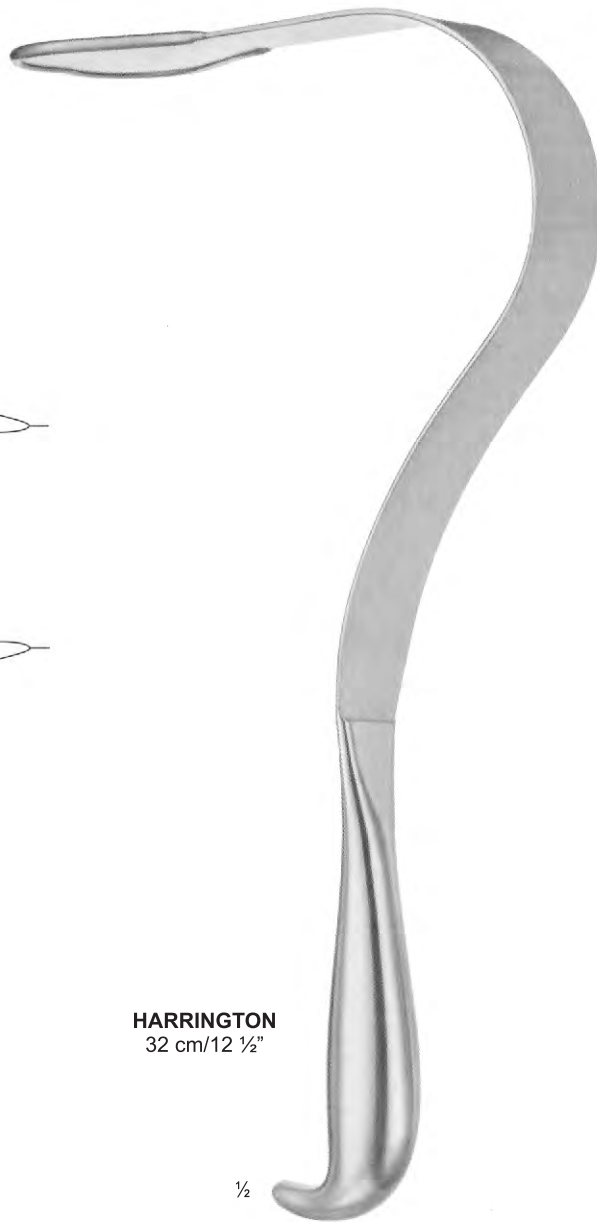
¼



62 x 180 mm

HARRINGTON-PEMBERTON

Ai 16-4501-32
 32 cm/12 ½"



HARRINGTON
 32 cm/12 ½"

½

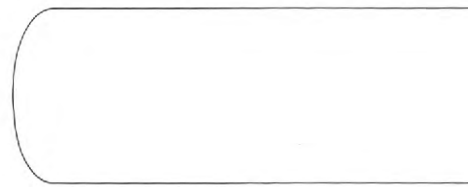
Measurements of retractors: Depth x Width



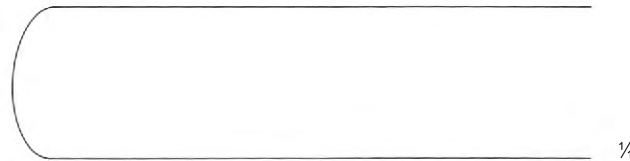
SAUERBRUCH
22.5 cm/8 ¾"



Ai 16-4502-22
45 x 15 mm



Ai 16-4503-22
60 x 23 mm



Ai 16-4504-22
72 x 20 mm



Measurements of retractors: Depth x Width





38 mm

50 mm

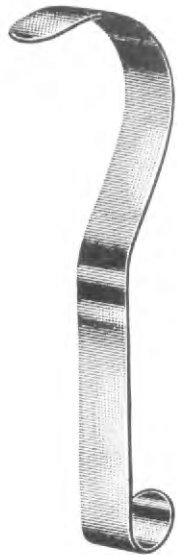
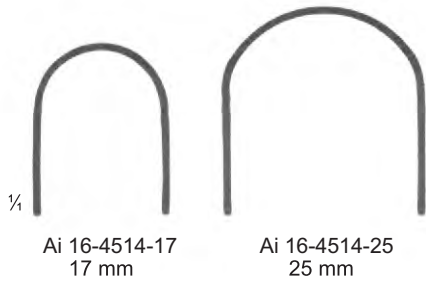
75 mm

DEAVER
Ai 16-4511-32
32 cm/12 1/2"

DEAVER
Ai 16-4512-31
31.5 cm/12 3/8"

DEAVER
Ai 16-4513-31
31.5 cm/12 3/8"

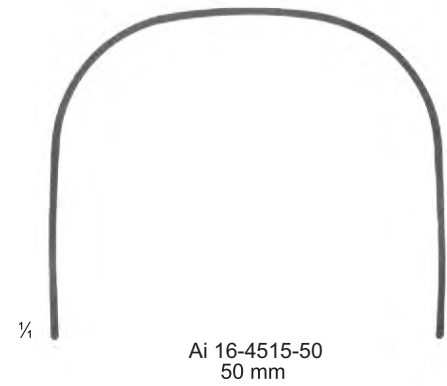
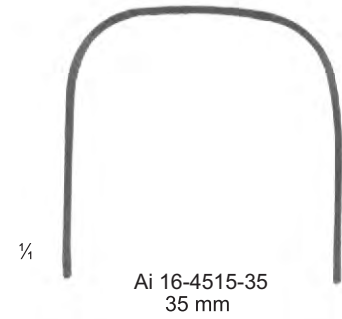
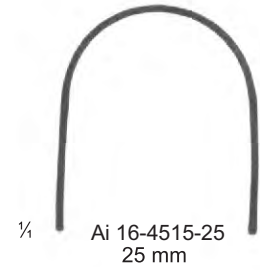




DEEVER-BABY



DEEVER





Ai 16-4516-29
 29.5 cm/11⁵/₈"
 width of blade 48 mm

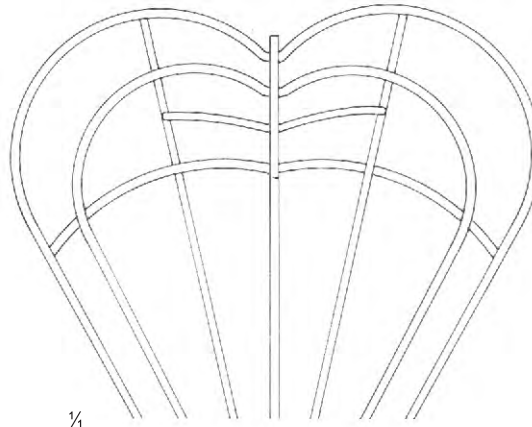
Ai 16-4516-33
 33 cm/13"
 width of blade 63 mm

ALLISON

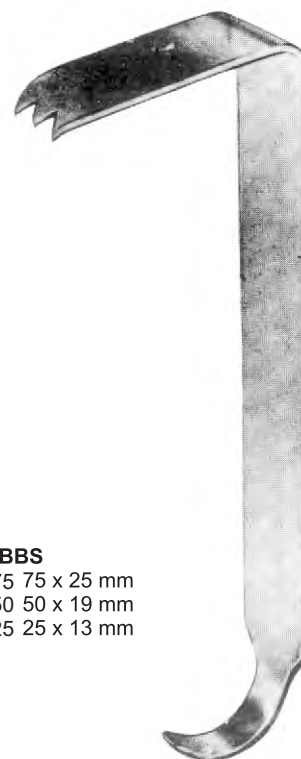


Ai 16-4517-29
 29.5 cm/11⁵/₈"
 width of blade 132 mm

ALLISON



1/4

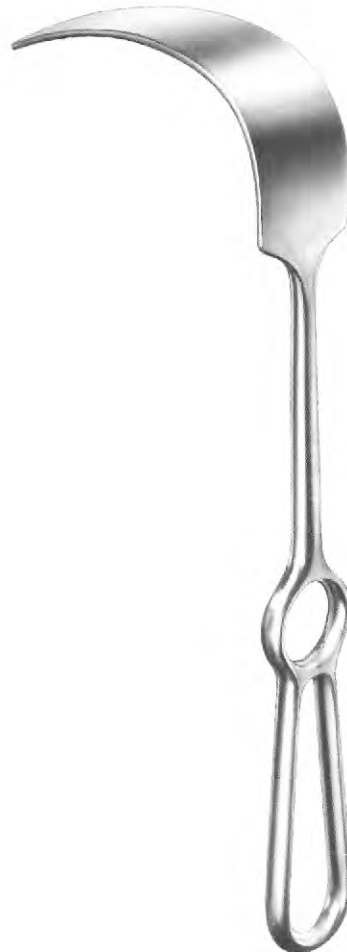
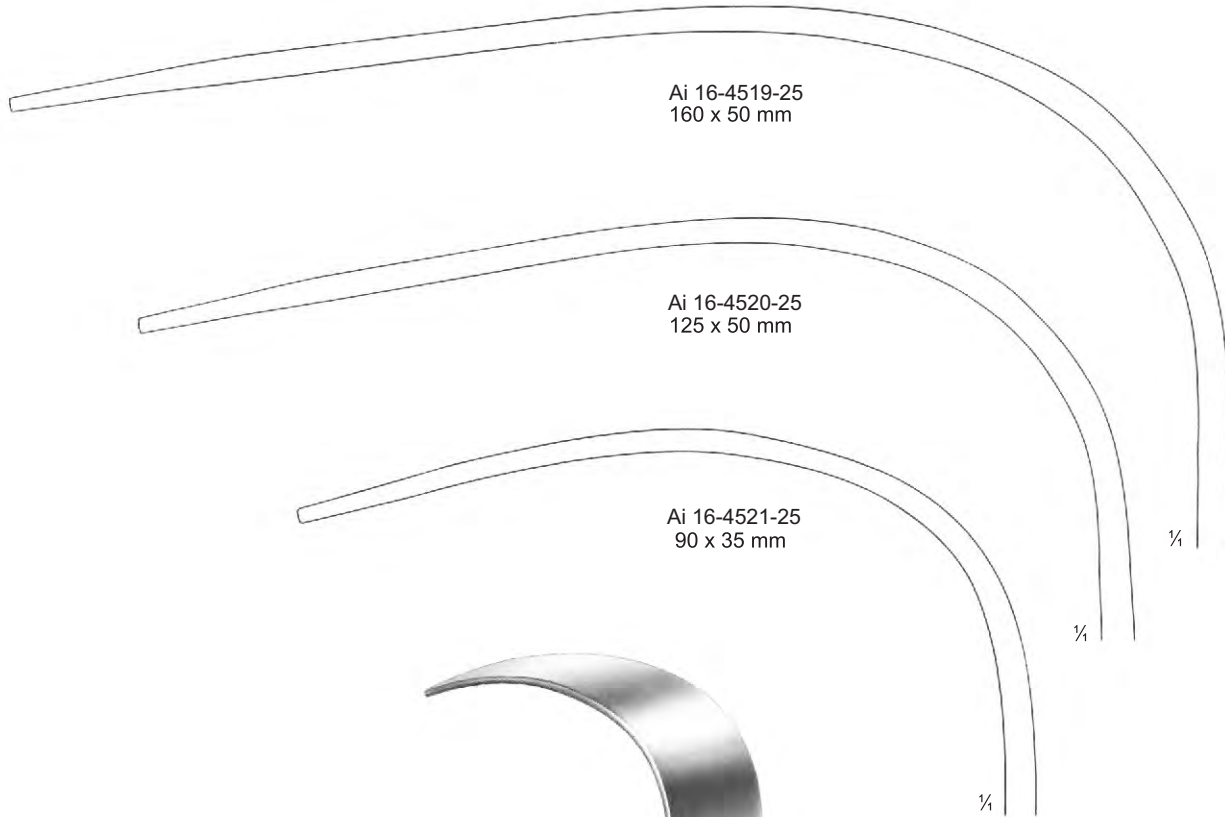


HIBBS

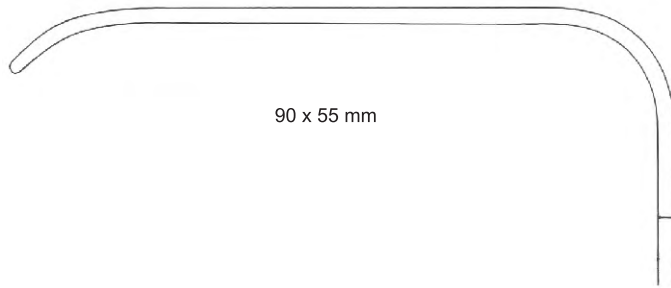
Ai 16-4518-75 75 x 25 mm
 Ai 16-4518-50 50 x 19 mm
 Ai 16-4518-25 25 x 13 mm

Measurements of retractors: Depth x Width

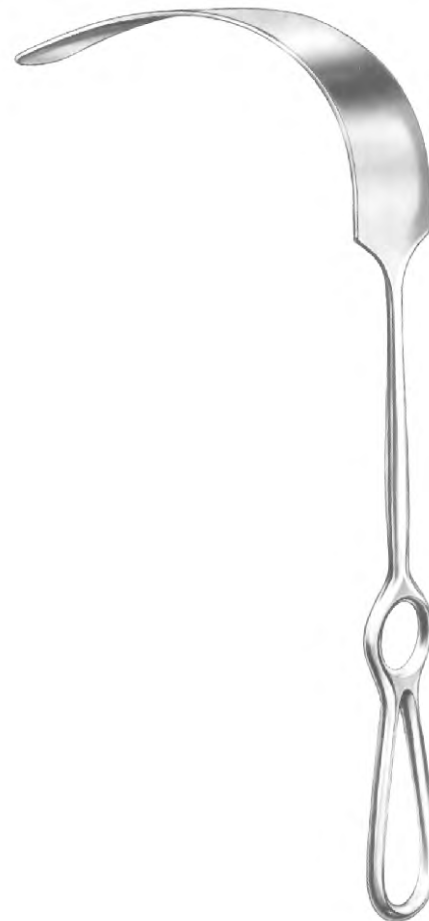
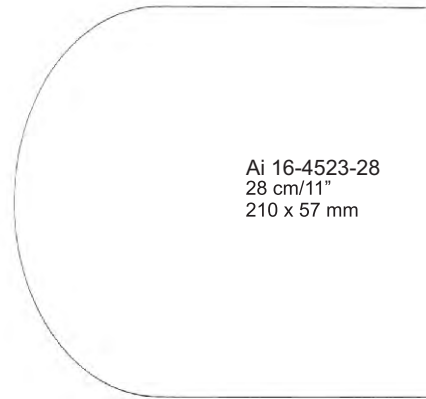
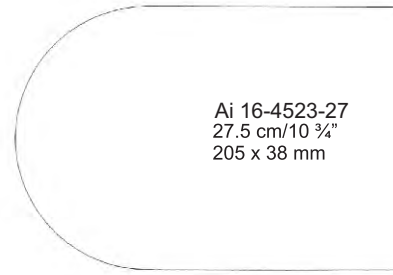




MIKULICZ
25 cm/9 7/8"

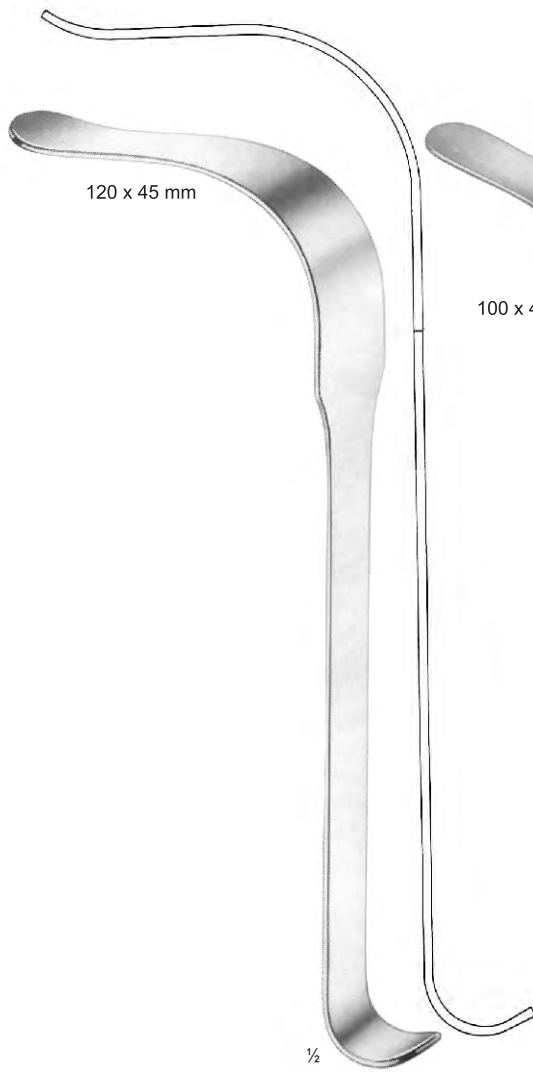


MIKULICZ
Ai 16-4522-26
26 cm/10 ¹/₈"



KELLY

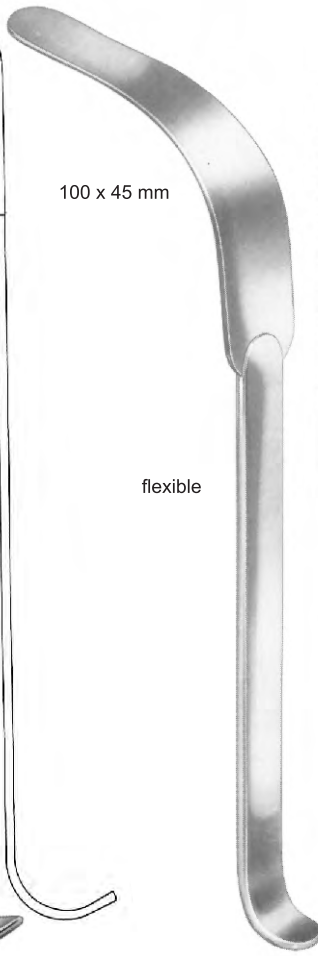




120 x 45 mm

½

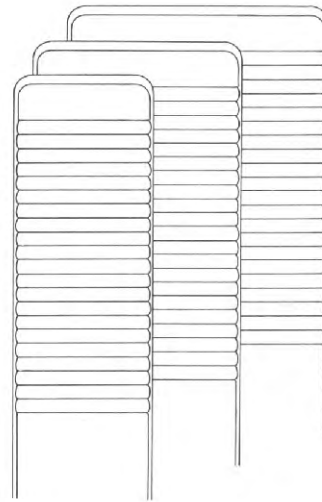
KOERTE
 Ai 16-4524-28
 28 cm/11"
 rigid



100 x 45 mm

flexible

KUMMEL
 Ai 16-4525-31
 31 cm/12 ¼"



KADER
 Ai 16-4526-20 = 20 mm
 Ai 16-4526-30 = 30 mm
 Ai 16-4526-40 = 40 mm
 28 cm/11"

Measurements of Spatulas : Depth x Width

RIBBON SPATULAS



TUFFIER
 20 cm/7 7/8"
 Ai 16-4527-20 17 x 25 mm
 malleable



Ai 16-4528-06 6 x 200 mm
 Ai 16-4528-12 12 x 200 mm
 Ai 16-4528-17 17 x 200 mm
 Ai 16-4528-25 25 x 200 mm
 malleable



Ai 16-4529-27 27 x 250 mm
 Ai 16-4529-35 35 x 250 mm
 malleable



Ai 16-4530-30 30 x 330 mm
 Ai 16-4530-40 40 x 330 mm
 Ai 16-4530-50 50 x 330 mm
 Ai 16-4530-75 75 x 330 mm
 malleable





malleable

HABERER

- Ai 16-4531-20 20 cm/7 7/8" 17 x 25 mm
- Ai 16-4531-28 28 cm/11" 25 x 30 mm
- Ai 16-4531-30 30 cm/11 3/4" 37 x 45 mm



- Ai 16-4532-20 6.5 mm
- Ai 16-4533-20 9.5 mm
- Ai 16-4534-20 13 mm
- Ai 16-4535-20 16 mm
- Ai 16-4536-20 19 mm
- Ai 16-4537-20 25 mm
- 20 cm/7 7/8"

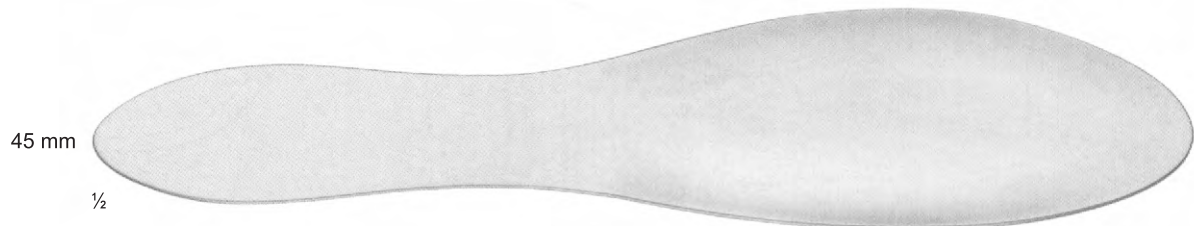


63 mm

45 mm

REVERDIN

- Ai 16-4538-28 28.5 cm/11 1/4"
- 63 x 45 mm



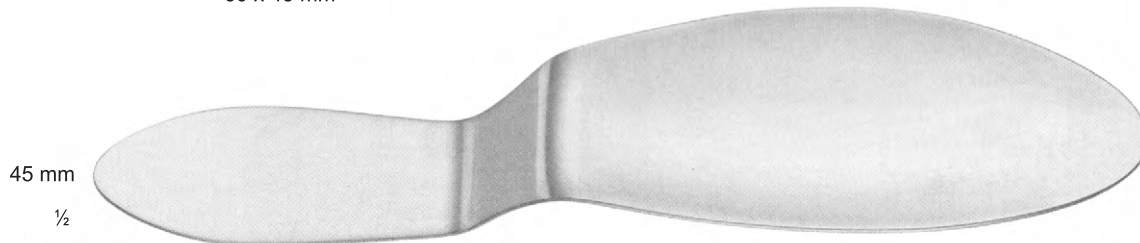
45 mm

60 mm

1/2

REVERDIN

- Ai 16-4539-29 29 cm/11 1/2"
- 60 x 45 mm



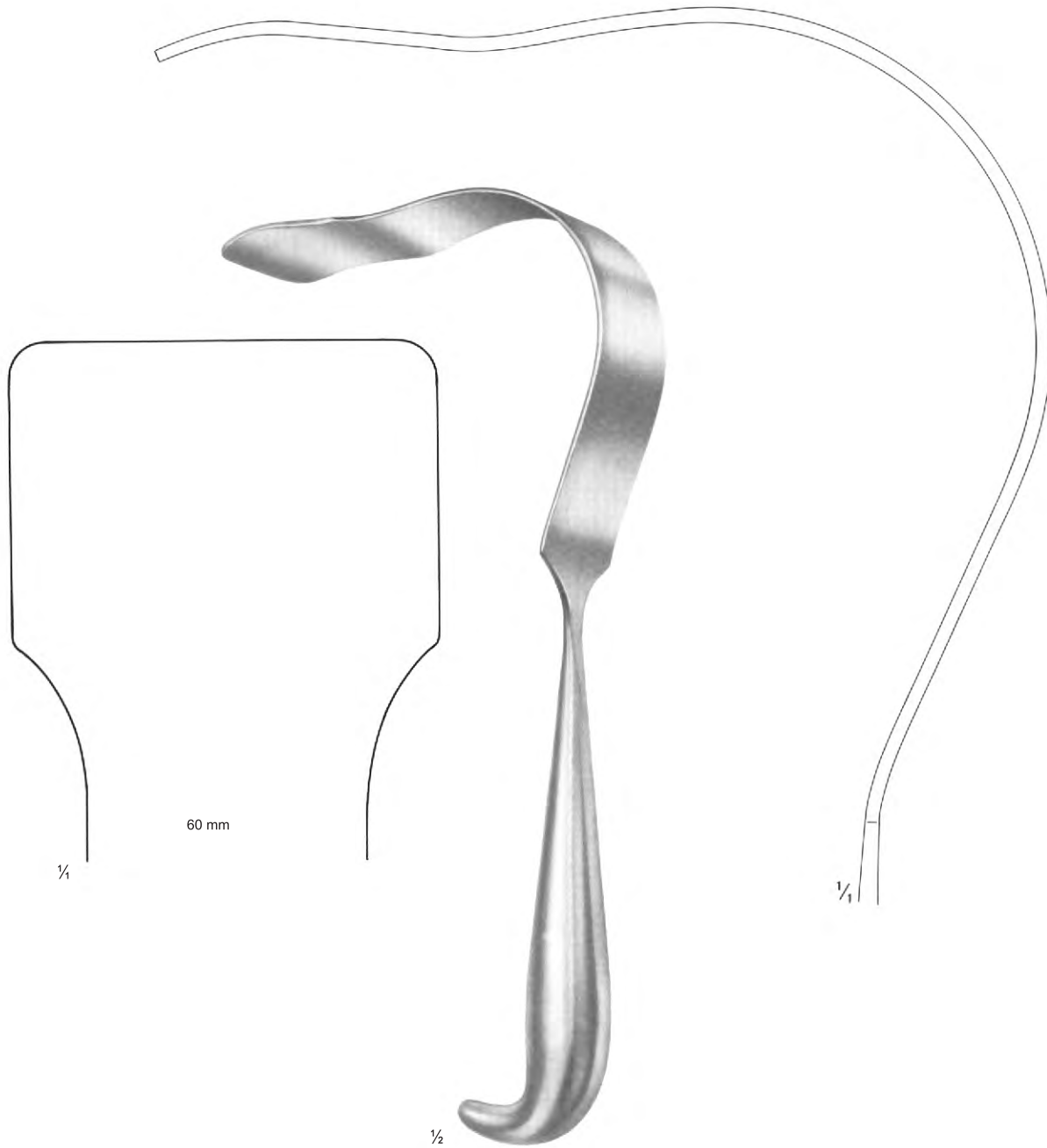
45 mm

60 mm

1/2

REVERDIN

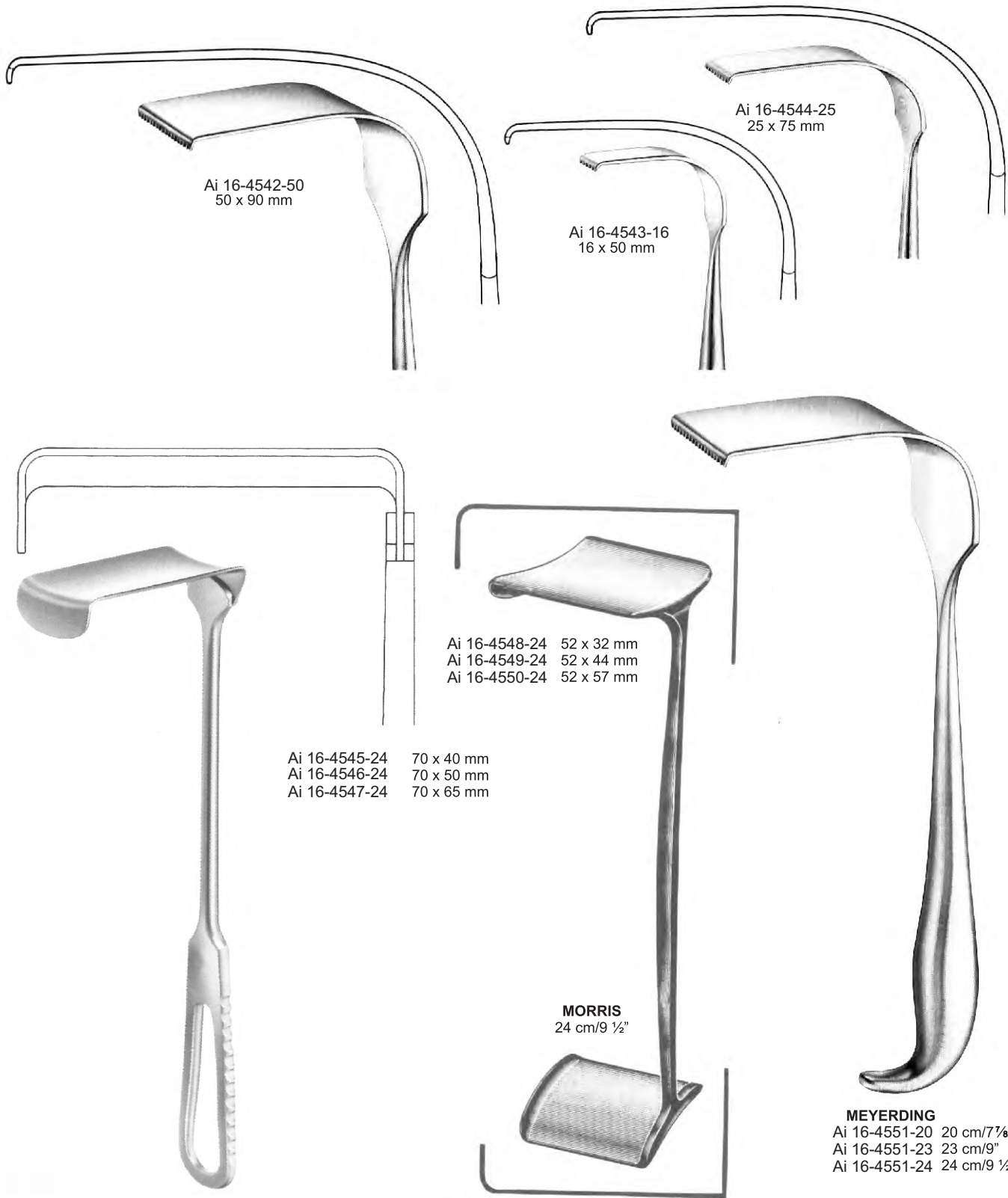
- Ai 16-4540-28 28 cm/11"
- 60 x 45 mm



POLLOSON
Ai 16-4541-29
29 cm/11 1/2"

Measurements of retractors: Depth x width

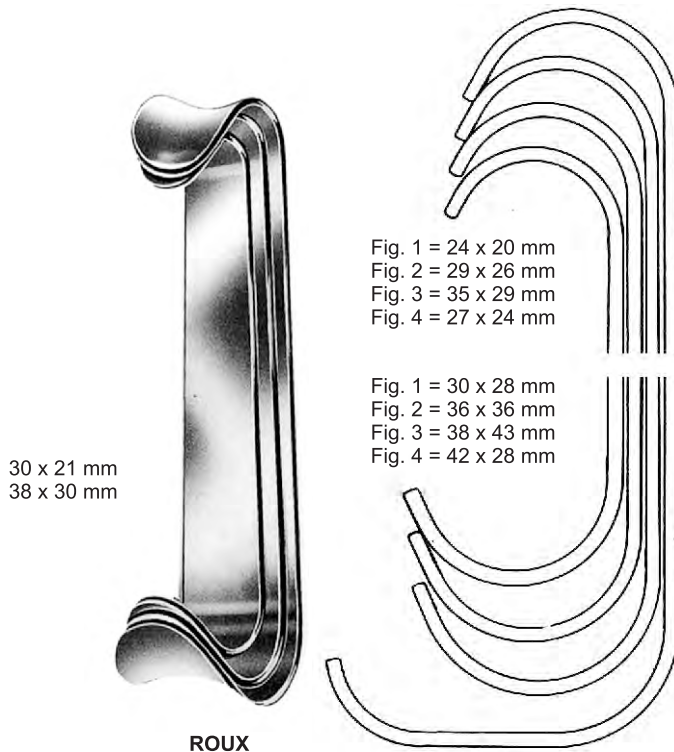




MORRIS
24.5 cm/9 7/8"

MEYERDING
 Ai 16-4551-20 20 cm/7 7/8"
 Ai 16-4551-23 23 cm/9"
 Ai 16-4551-24 24 cm/9 1/2"

Measurements of Spatulas : Depth x Width



30 x 21 mm
 38 x 30 mm

Fig. 1 = 24 x 20 mm
 Fig. 2 = 29 x 26 mm
 Fig. 3 = 35 x 29 mm
 Fig. 4 = 27 x 24 mm

Fig. 1 = 30 x 28 mm
 Fig. 2 = 36 x 36 mm
 Fig. 3 = 38 x 43 mm
 Fig. 4 = 42 x 28 mm

ROUX

- Ai 16-4552-01 Set Fig. 1 - 3
- Ai 16-4552-14 Fig. 1 14 cm/5 1/2"
- Ai 16-4552-15 Fig. 2 15 cm/5 7/8"
- Ai 16-4552-17 Fig. 3 17 cm/6 3/4"
- Ai 16-4552-18 Fig. 4 18 cm/7 1/8"

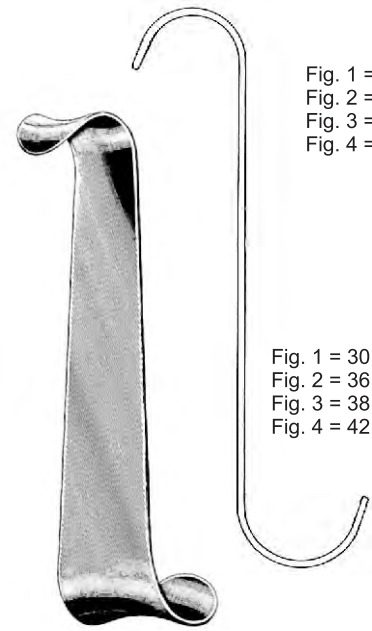


Fig. 1 = 24 x 20 mm
 Fig. 2 = 29 x 26 mm
 Fig. 3 = 35 x 39 mm
 Fig. 4 = 27 x 24 mm

Fig. 1 = 30 x 28 mm
 Fig. 2 = 36 x 36 mm
 Fig. 3 = 38 x 43 mm
 Fig. 4 = 42 x 28 mm

ROUX-MAGNUS

- Ai 16-4553-01 Set Fig. 1 - 3
- Ai 16-4553-14 Fig. 1 14 cm/5 1/2"
- Ai 16-4553-15 Fig. 2 15 cm/5 7/8"
- Ai 16-4553-17 Fig. 3 17 cm/6 3/4"
- Ai 16-4553-18 Fig. 4 18 cm/7 1/8"

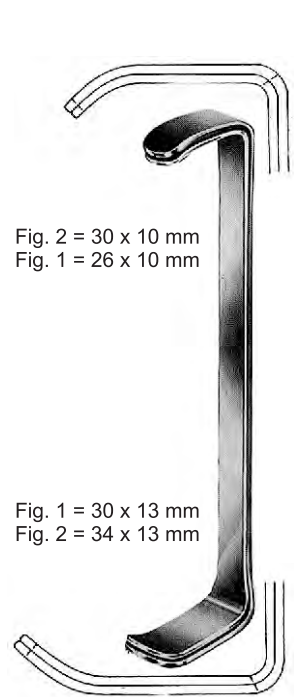


Fig. 2 = 30 x 10 mm
 Fig. 1 = 26 x 10 mm

Fig. 1 = 30 x 13 mm
 Fig. 2 = 34 x 13 mm

FARABEUFG

- Ai 16-4554-11 Set
- Ai 16-4555-11 Fig. 1
- Ai 16-4556-11 Fig. 2
- 11.5 cm/4 1/2"

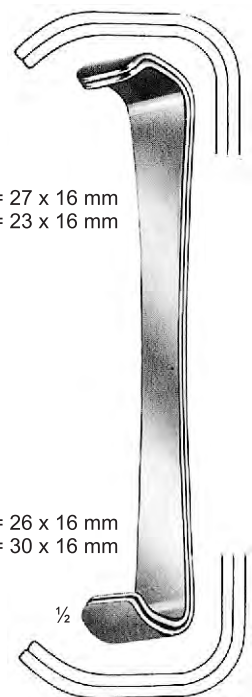
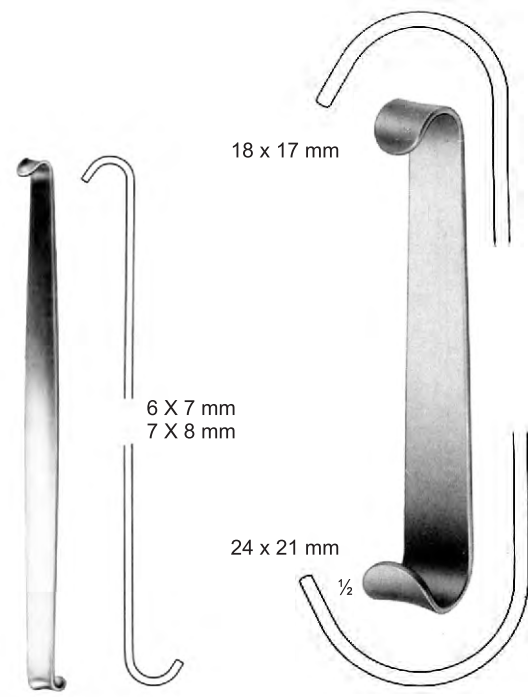


Fig. 2 = 27 x 16 mm
 Fig. 1 = 23 x 16 mm

Fig. 1 = 26 x 16 mm
 Fig. 2 = 30 x 16 mm

FARABEUFG

- Ai 16-4557-15 Set
- Ai 16-4558-15 Fig. 1
- Ai 16-4559-15 Fig. 2
- 15 cm/5 7/8"



6 X 7 mm
 7 X 8 mm

18 x 17 mm

24 x 21 mm

MINI-ROUX

- Ai 16-4560-14
- 14 cm/5 1/2"

BABY ROUX

- Ai 16-4561-13
- 13 cm/5 1/8"





Fig. 2 = 22 x 15 mm
 Fig. 1 = 19 x 15 mm

Fig. 1 = 19 x 15 mm
 Fig. 2 = 22 x 15 mm

PARKER

- Ai 16-4562-13 Set
- Ai 16-4563-13 Fig. 1
- Ai 16-4564-13 Fig. 2
- 13.5 cm/5 3/8"

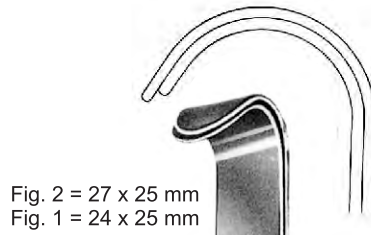


Fig. 2 = 27 x 25 mm
 Fig. 1 = 24 x 25 mm

Fig. 1 = 26 x 25 mm
 Fig. 2 = 29 x 25 mm

PARKER

- Ai 16-4565-18 Set
- Ai 16-4566-18 Fig. 1
- Ai 16-4567-18 Fig. 2
- 18 cm/7 1/8"

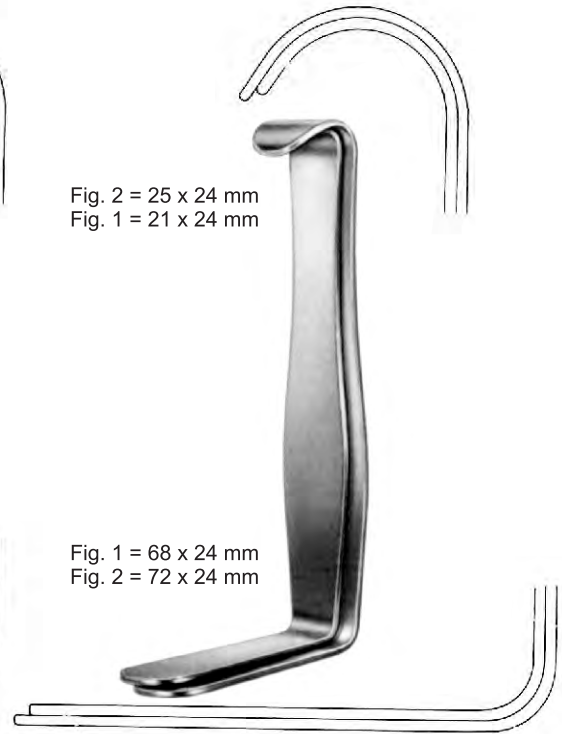


Fig. 2 = 25 x 24 mm
 Fig. 1 = 21 x 24 mm

Fig. 1 = 68 x 24 mm
 Fig. 2 = 72 x 24 mm

PARKER-MOTT

- Ai 16-4568-16 Set
- Ai 16-4569-16 Fig. 1
- Ai 16-4570-16 Fig. 2
- 16 cm/6 1/4"

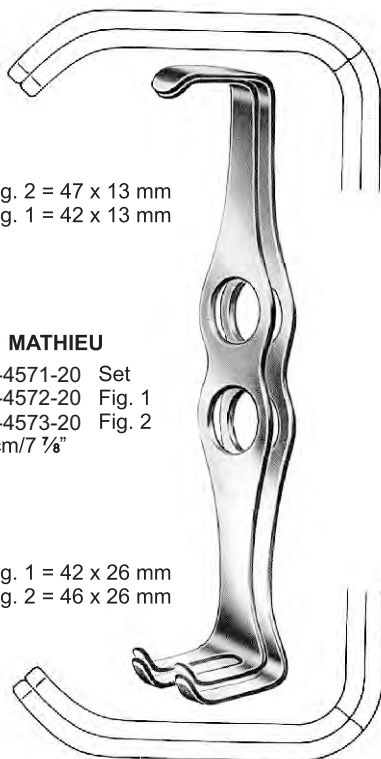


Fig. 2 = 47 x 13 mm
 Fig. 1 = 42 x 13 mm

MATHIEU

- Ai 16-4571-20 Set
- Ai 16-4572-20 Fig. 1
- Ai 16-4573-20 Fig. 2
- 20 cm/7 7/8"

Fig. 1 = 42 x 26 mm
 Fig. 2 = 46 x 26 mm

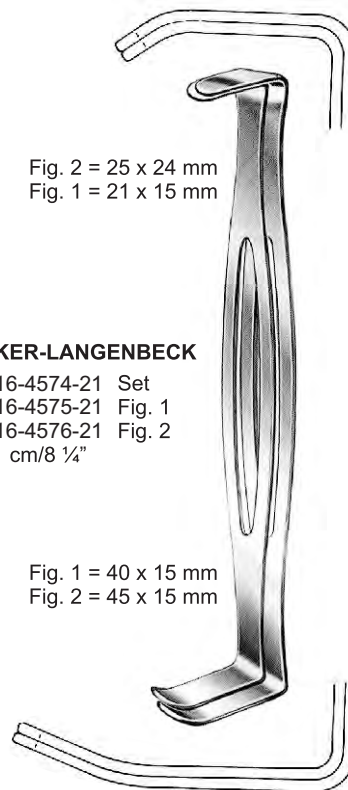
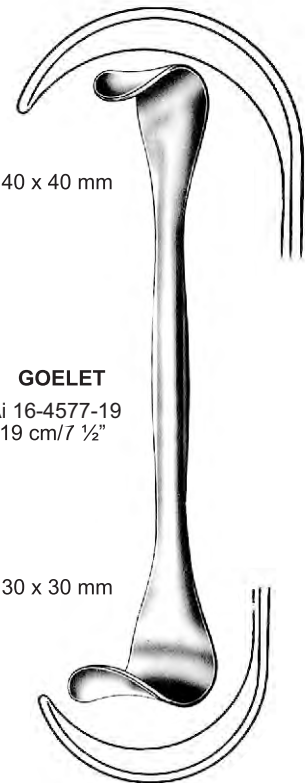


Fig. 2 = 25 x 24 mm
 Fig. 1 = 21 x 15 mm

PARKER-LANGENBECK

- Ai 16-4574-21 Set
- Ai 16-4575-21 Fig. 1
- Ai 16-4576-21 Fig. 2
- 21 cm/8 1/4"

Fig. 1 = 40 x 15 mm
 Fig. 2 = 45 x 15 mm



40 x 40 mm

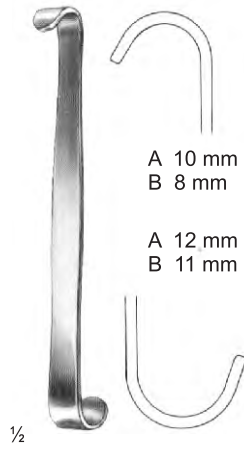
GOELET

- Ai 16-4577-19
- 19 cm/7 1/2"

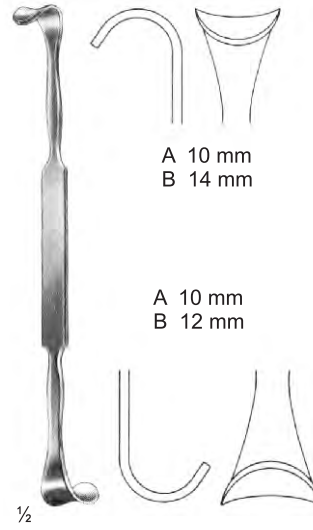
30 x 30 mm



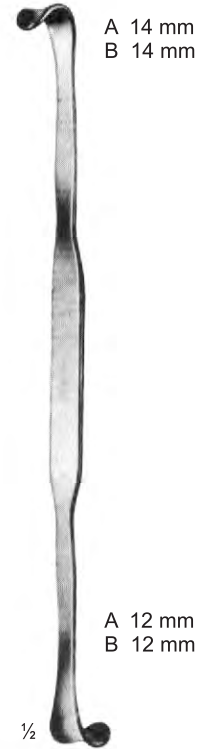
CRILE
 Ai 16-4578-11
 11 cm/4 3/8"



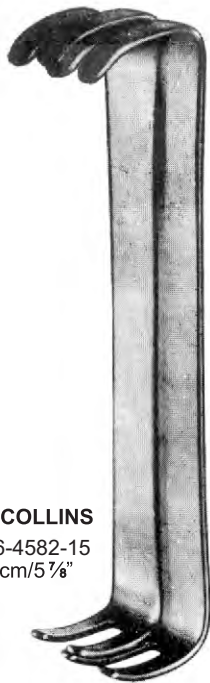
LUER
 Ai 16-4579-11
 11 cm/4 3/8"



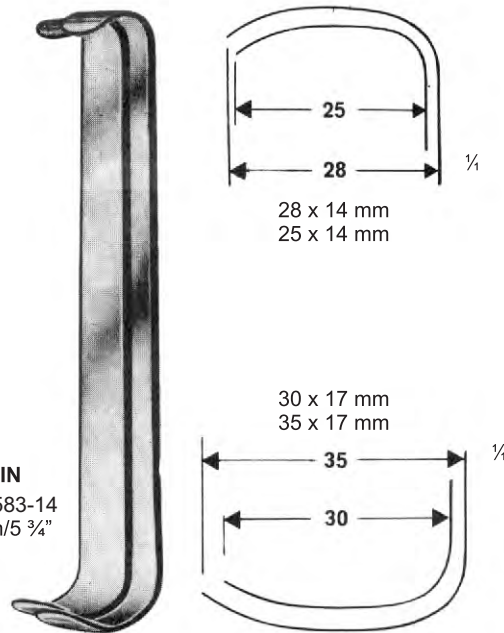
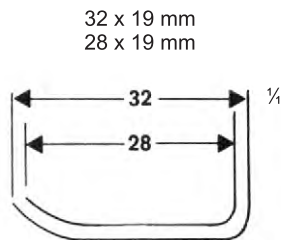
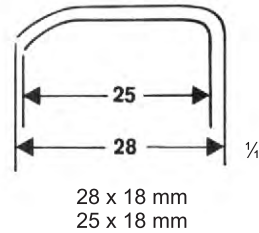
ROSE
 Ai 16-4580-13
 13 cm/5 1/8"



ROSE
 Ai 16-4581-19
 19.5 cm/7 1/2"

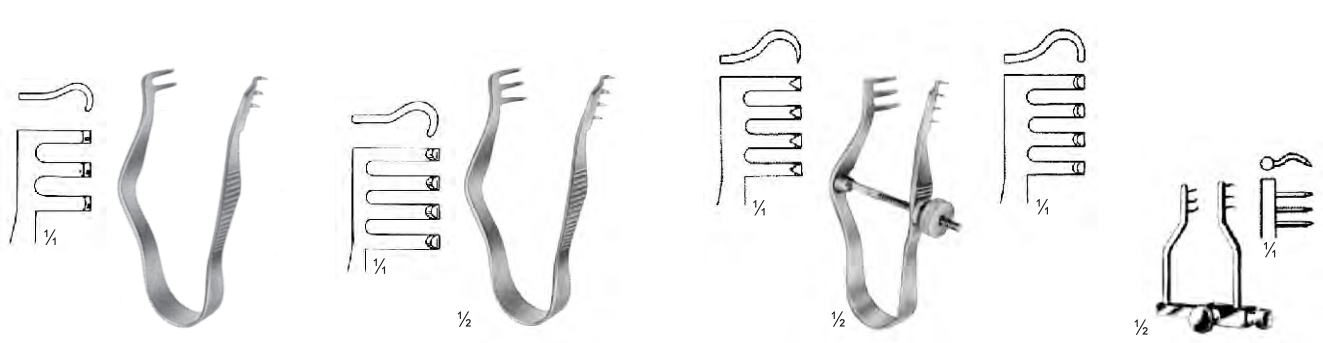


MAYO-COLLINS
 Ai 16-4582-15
 15 cm/5 7/8"



COLLIN
 Ai 16-4583-14
 14.5 cm/5 3/4"



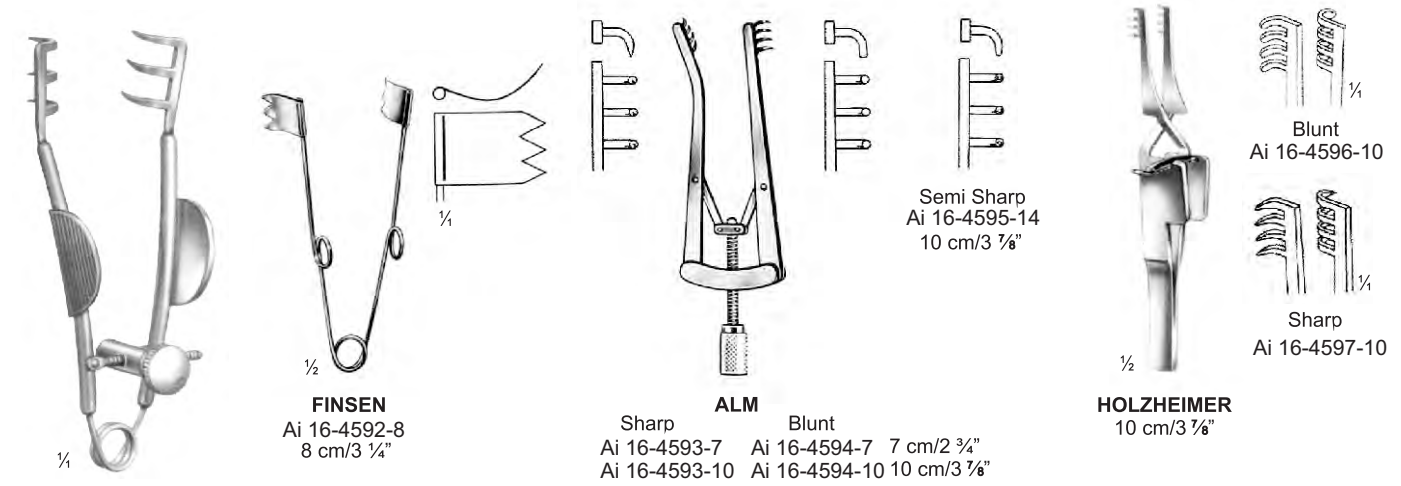


FINSEN
 5 cm/2"
 Ai 16-4584-5
 Ai 16-4585-5
 spreading 16 mm

FINSEN
 7 cm/2 3/4"
 Ai 16-4586-7
 Ai 16-4587-7
 spreading 20 mm

FINSEN
 7 cm/2 3/4"
 sharp Ai 16-4588-7
 blunt Ai 16-4589-7
 spreading 30 mm

LOGAN
 4 cm/1 5/8"
 Ai 16-4590-4
 sharp
 spreading 16 mm



BUCKLEY
 Ai 16-4591-6
 6 cm/2 1/4"
 sharp

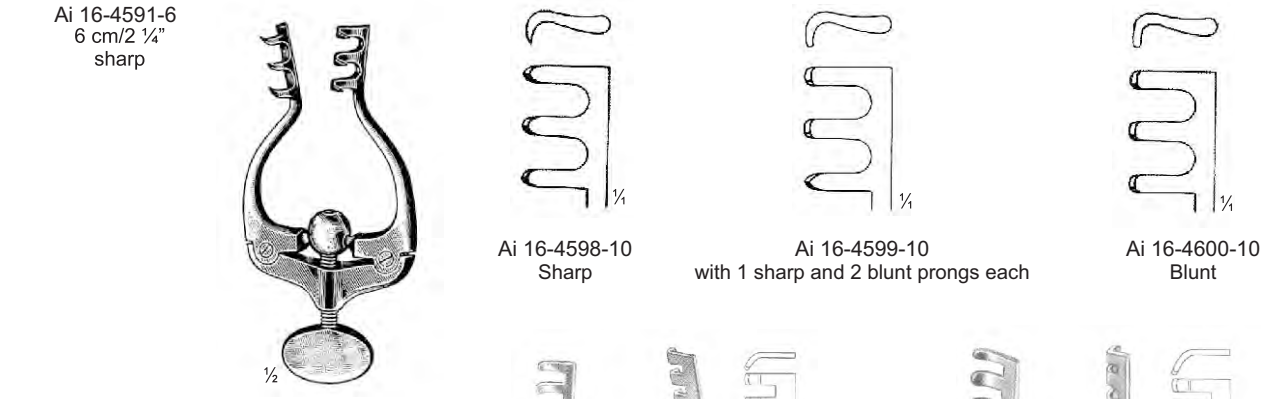
FINSEN
 Ai 16-4592-8
 8 cm/3 1/4"

ALM
 Sharp Ai 16-4593-7
 Blunt Ai 16-4594-7
 Ai 16-4593-10 Ai 16-4594-10
 7 cm/2 3/4"
 10 cm/3 7/8"

HOLZHEIMER
 10 cm/3 7/8"

Blunt
 Ai 16-4596-10

Sharp
 Ai 16-4597-10

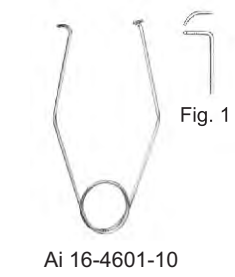


JANZEN
 10 cm/3 7/8"

Ai 16-4598-10
 Sharp

Ai 16-4599-10
 with 1 sharp and 2 blunt prongs each

Ai 16-4600-10
 Blunt



Ai 16-4601-10

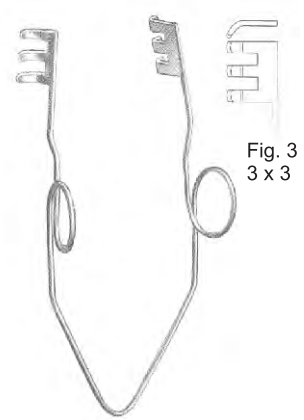


Fig. 3
 3 x 3

Ai 16-4602-00



Fig. 2
 3 x 3

Ai 16-4603-00



WEITLANER
2 : 2

Ai 16-4604-13 sharp
 Ai 16-4605-13 blunt
 13.5 cm/5 3/8"



1/2

WEITLANER
2 : 2

Ai 16-4606-13 semi sharp
 13.5 cm/5 3/8"

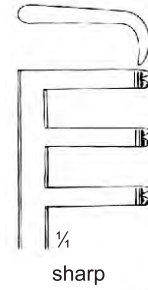
WEITLANER
2 : 3

Ai 16-4607-10 sharp
 Ai 16-4608-10 blunt
 10.5 cm/4 1/8"

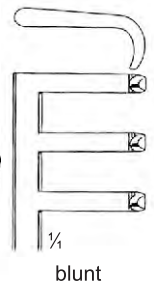


WEITLANER
3 : 4

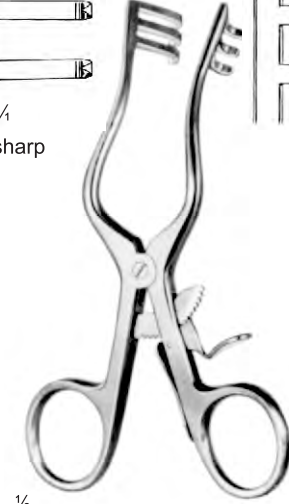
Ai 16-4609-13 13 cm/5 1/8" sharp
 Ai 16-4610-13 13 cm/5 1/8" blunt
 Ai 16-4611-16 16.5 cm/6 1/2" sharp
 Ai 16-4512-16 16.5 cm/6 1/2" blunt



1/4 sharp



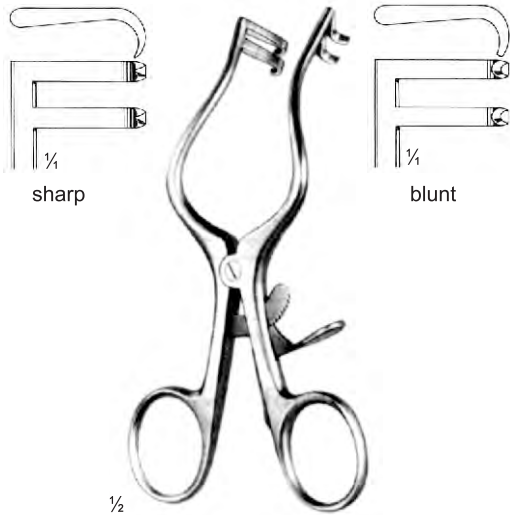
1/4 blunt



1/2

WEITLANER-WULLSTEIN
3 : 3

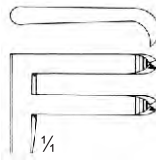
Ai 16-4613-13 sharp
 Ai 16-4614-13 blunt
 13 cm/5 1/8"



1/2

PLESTER

Ai 16-4615-13 sharp
 Ai 16-4616-13 blunt
 13 cm/5 1/8"



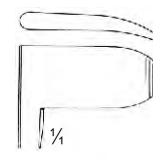
1/4



1/2

PLESTER
Blunt

Ai 16-4617-10
 10.5 cm/4 1/8"



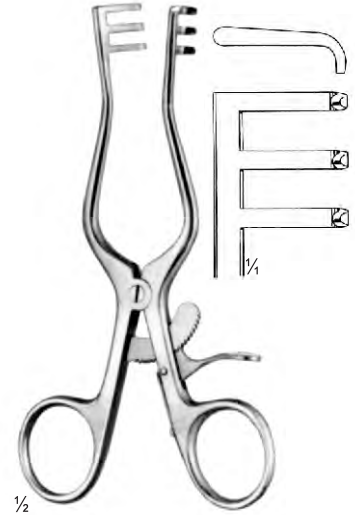
1/4



1/2

PLESTER
Blunt

Ai 16-4618-10
 10.5 cm/4 1/8"



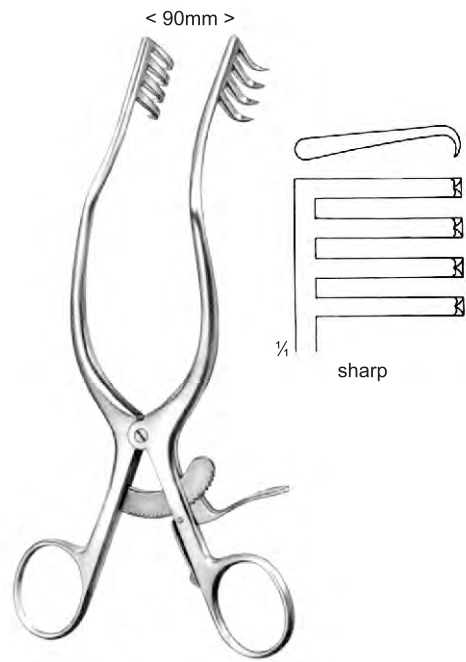
1/2

MILLIGAN
Blunt

Ai 16-4619-13
 13.5 cm/5 3/8"

Measurements of Retractors : Depth x Width

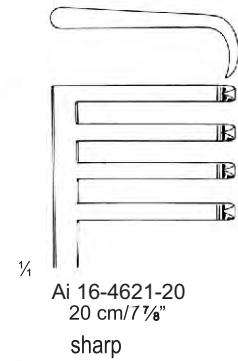




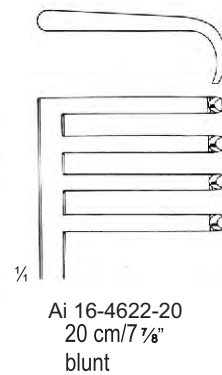
ANDERSON - ADSON
 4 : 4
 Ai 16-4620-19
 19 cm / 7 1/2"



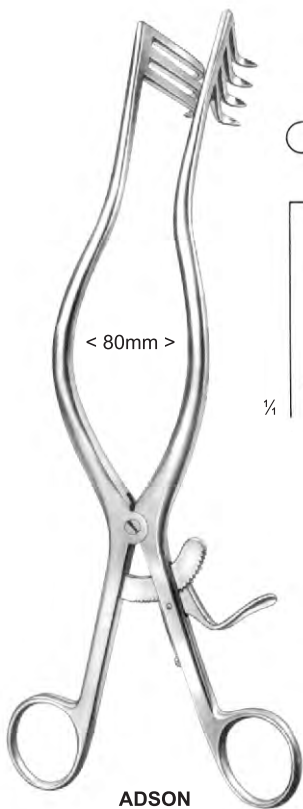
WEITLANER
 3 : 4



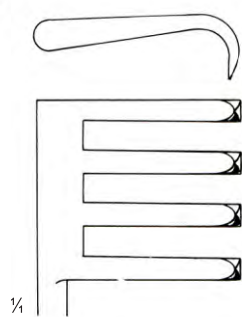
Ai 16-4621-20
 20 cm / 7 7/8"
 sharp



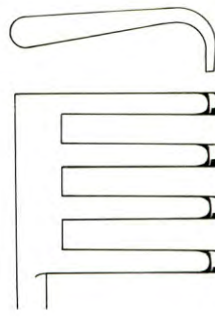
Ai 16-4622-20
 20 cm / 7 7/8"
 blunt



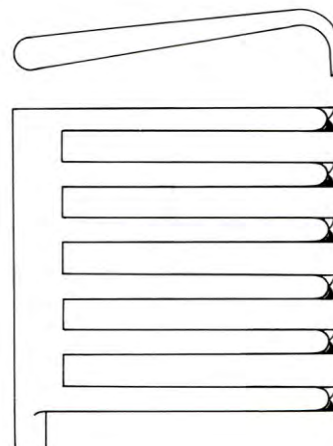
ADSON



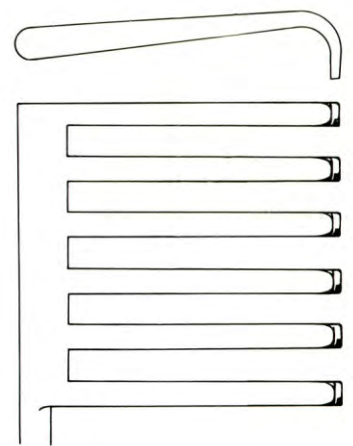
sharp
 3 : 4 teeth
 Ai 16-4623-26
 26 cm / 10 1/4"



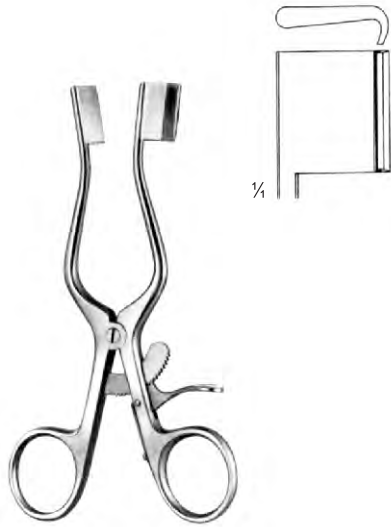
blunt
 3 : 4 teeth
 Ai 16-4624-26
 26 cm / 10 1/4"



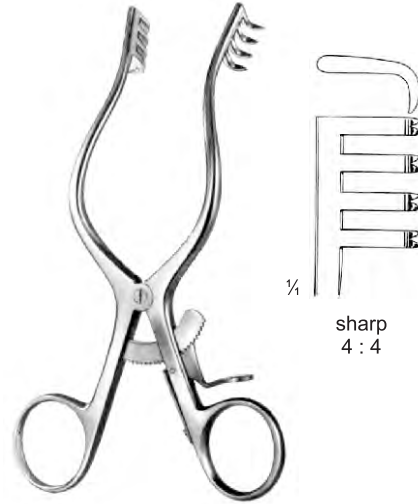
sharp
 6 : 6 teeth
 Ai 16-4625-29
 29 cm / 11 1/2"



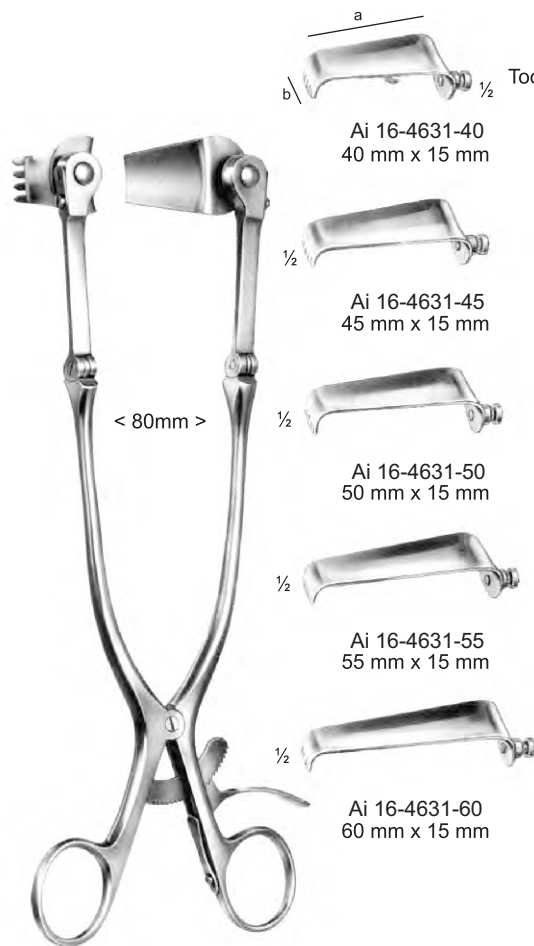
blunt
 6 : 6 teeth
 Ai 16-4626-29
 29 cm / 11 1/2"



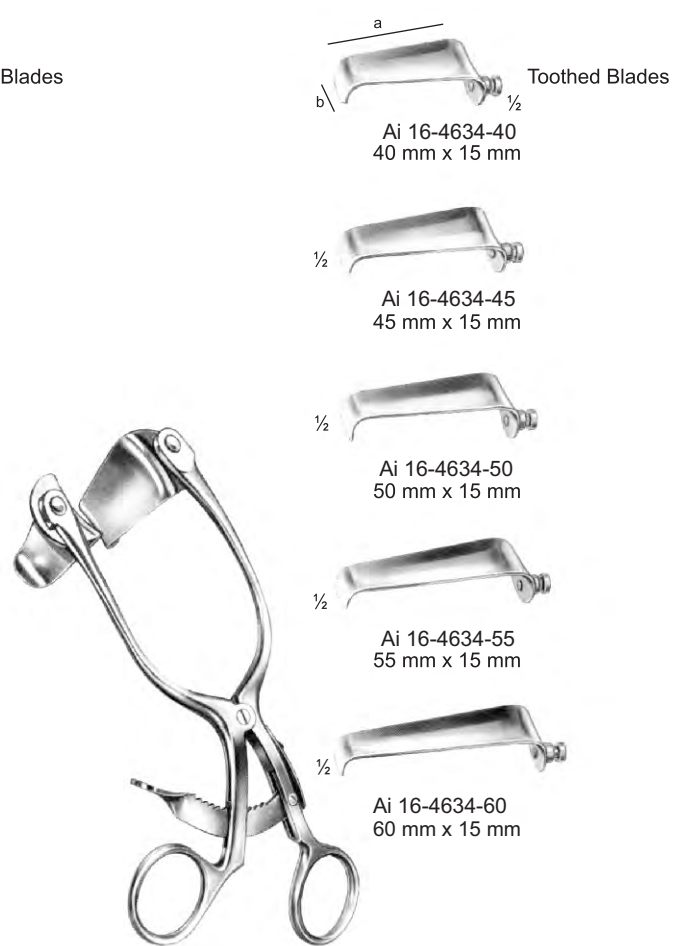
WEITLANER-BABY
 Ai 16-4627-13
 13.5 cm/5 3/8"



MOLLISON
 Ai 16-4628-15
 15.5 cm/6 1/8"



CLOWARD
 Ai 16-4629-25 - Retractor complete (with 2 blades ea.)
 Ai 16-4630-25 - Retractor only
 25 cm/9 7/8"



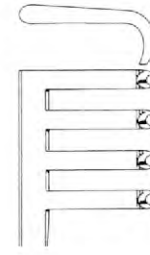
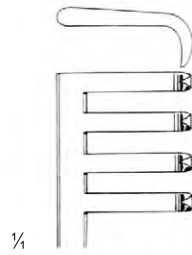
CLOWARD
 Ai 16-4632-16 - Retractor complete (with 2 blades ea.)
 Ai 16-4633-16 - Retractor only
 16 cm/6 1/4"





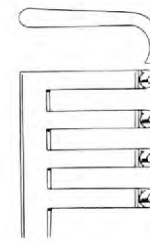
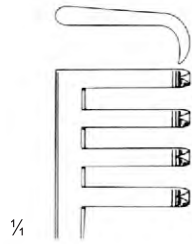
sharp

blunt



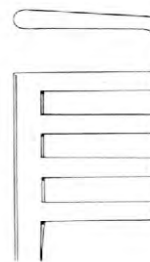
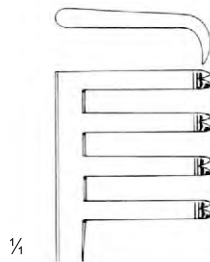
Ai 16-4635-13
 13.5 cm/5 3/8"
 3 : 4

Ai 16-4636-13
 13.5 cm/5 3/8"
 3 : 4



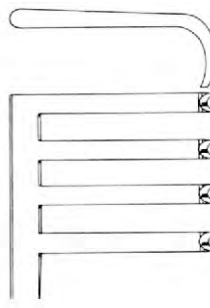
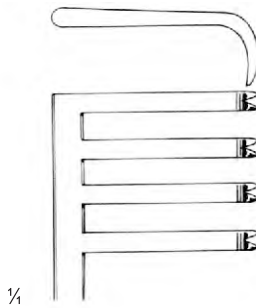
Ai 16-4637-16
 16.5 cm/6 1/2"
 3 : 4

Ai 16-4638-16
 16.5 cm/6 1/2"
 3 : 4



Ai 16-4639-21
 21 cm/8 1/4"
 3 : 4

Ai 16-4640-21
 21 cm/8 1/4"
 3 : 4

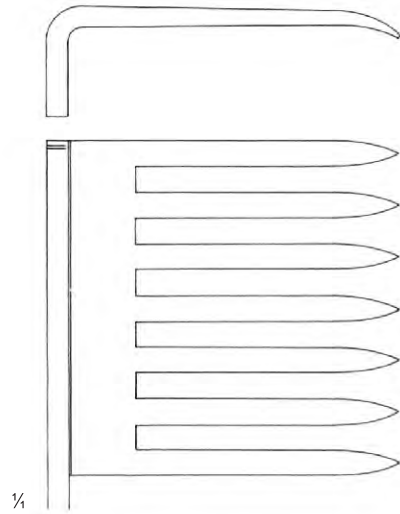
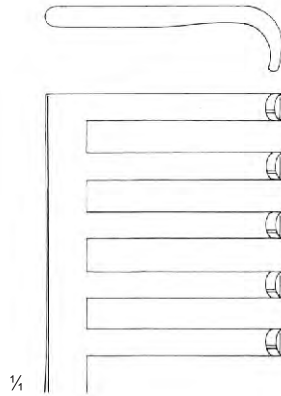
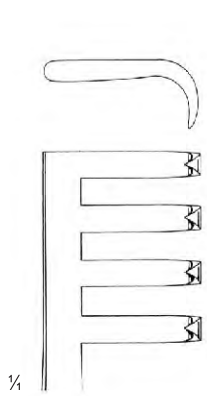


Ai 16-4641-24
 24.5 cm/9 5/8"
 3 : 4

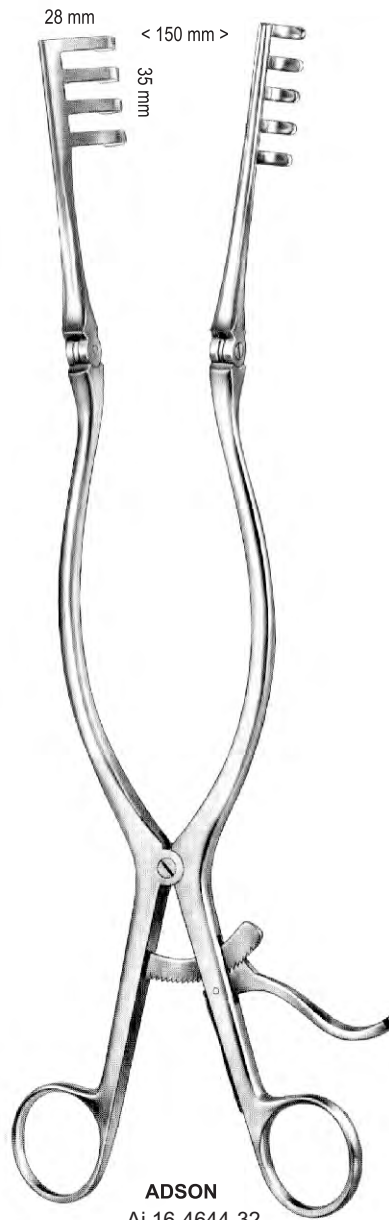
Ai 16-4642-24
 24.5 cm/9 5/8"
 3 : 4



ADSON



BECKMANN
 Ai 16-4643-31
 31 cm/12 1/4"
 4 : 4
 sharp



ADSON
 Ai 16-4644-32
 32 cm/12 1/2"
 4 : 5
 blunt



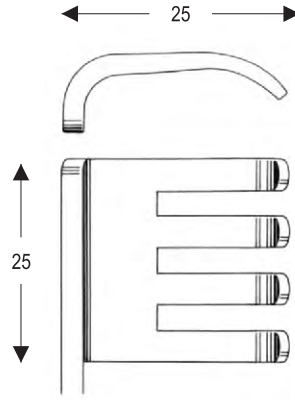
BECKMANN-EATON
 Ai 16-4645-32
 32 cm/12 1/2"
 7 : 7
 Sharp

Measurements of retractors: Depth x Width

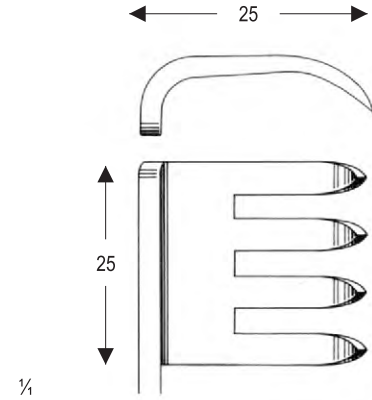




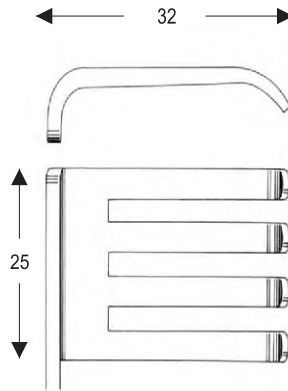
BECKMAN-ADSON
 30.5 cm/12"
 4 : 4



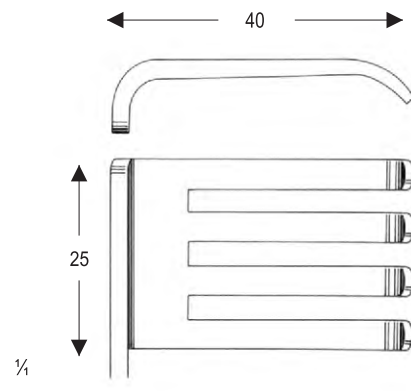
Ai 16-4646-30
 blunt



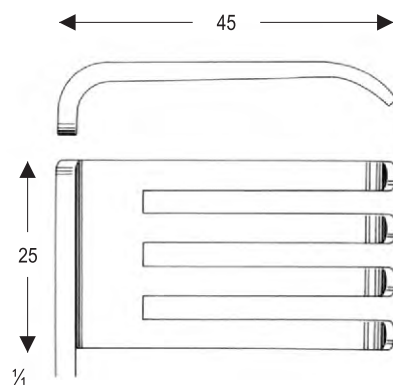
Ai 16-4647-30
 sharp



Ai 16-4648-30
 blunt



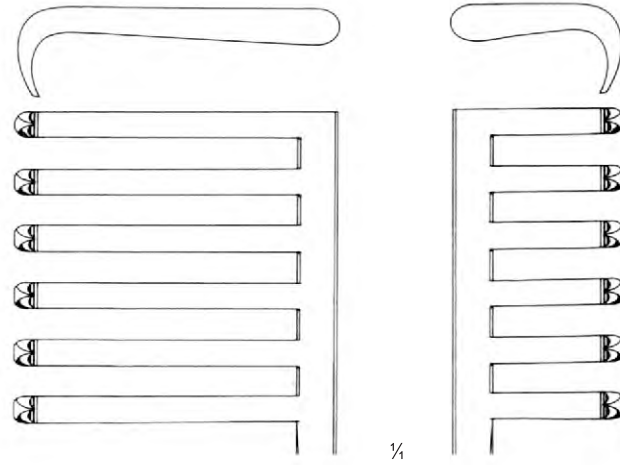
Ai 16-4649-30
 blunt



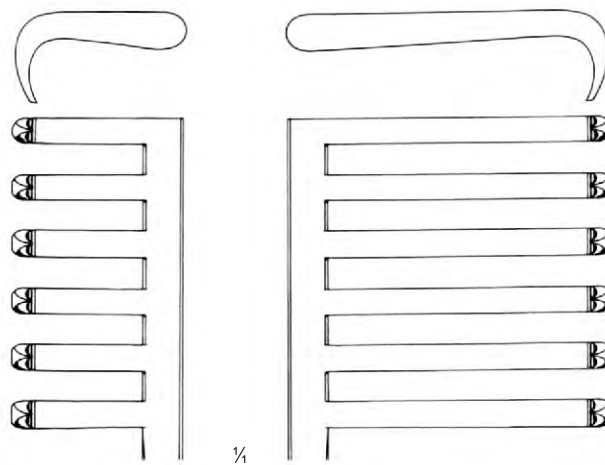
Ai 16-4650-30
 blunt



28.5 cm/11 1/4"
 6 : 6



Ai 16-4651-28
 Sharp, long teeth on left side

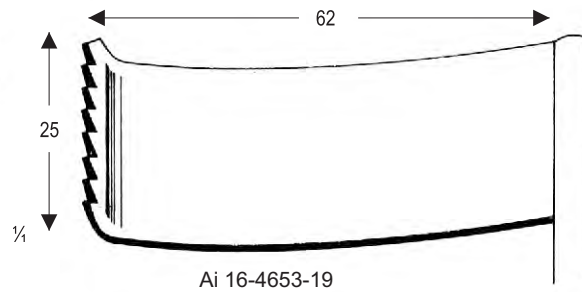


Ai 16-4652-28
 Sharp, long teeth on right side

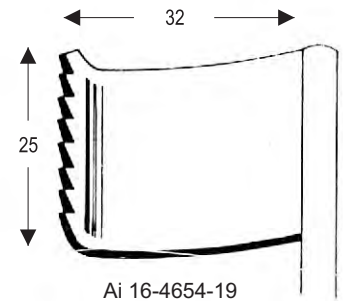




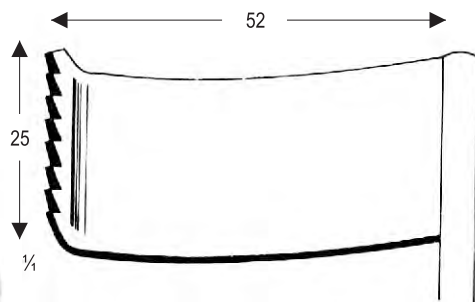
MEYERDING
 19 cm/7 1/2"



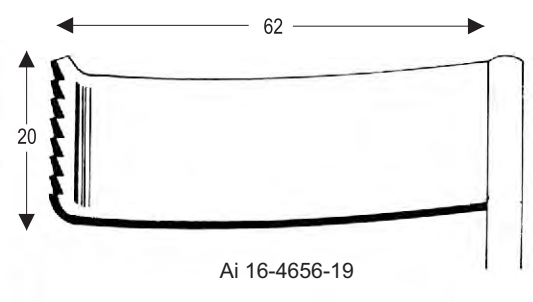
Ai 16-4653-19



Ai 16-4654-19



Ai 16-4655-19



Ai 16-4656-19

Measurements of retractors: Depth x Width

Lateral Blade
25 x 50 mm



½

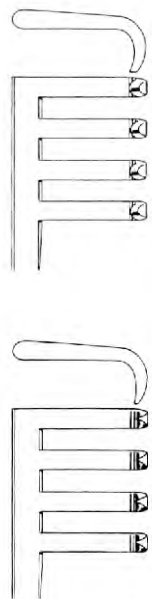
MARKHAM-MEYERDING
 Ai 16-4657-18
 18 cm/7 ¼"

Lateral Blade
25 x 50 mm



½

MARKHAM-MEYERDING
 Ai 16-4658-18
 18 cm/7 ¼"



½

HENLEY
 16 cm/6 ¼"



Ai 16-4659-16
 19 x 16 mm



Ai 16-4660-16
 25 x 16 mm



Ai 16-4661-16
 32 x 16 mm

Measurements of retractors: Depth x Width





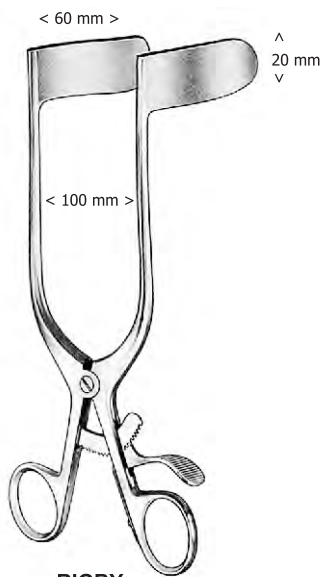
GELPI

- Ai 16-4662-09 9 cm/3 1/2"
- Ai 16-4662-11 11 cm/4 3/8"
- Ai 16-4662-13 13 cm/5 1/8"
- Ai 16-4662-14 14 cm/5 1/2"
- Ai 16-4662-16 16 cm/6 1/4"
- Ai 16-4662-18 18 cm/7 1/8"

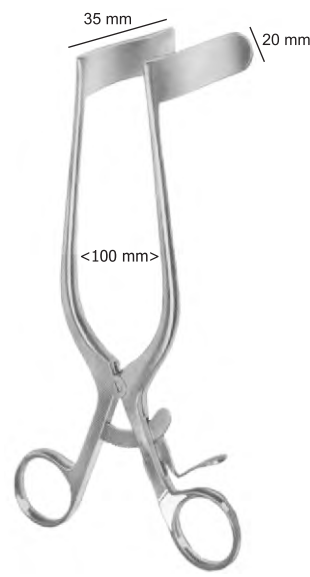


GELPI-LOKTITE

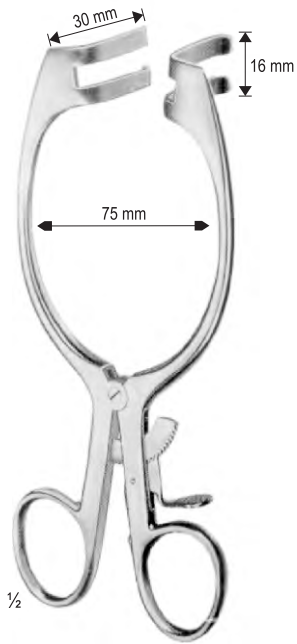
- Ai 16-4663-09 9 cm/3 1/2"
- Ai 16-4663-11 11 cm/4 3/8"
- Ai 16-4663-13 13 cm/5 1/8"
- Ai 16-4663-14 14 cm/5 1/2"
- Ai 16-4663-16 16 cm/6 1/4"
- Ai 16-4663-18 18 cm/7 1/8"



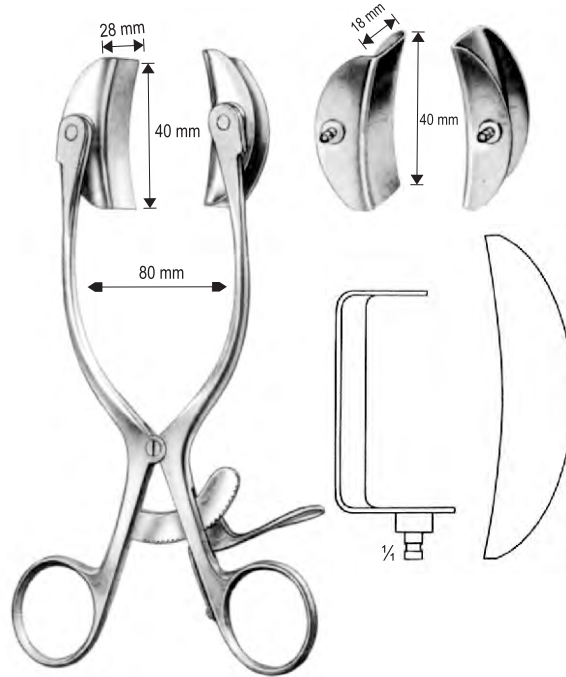
RIGBY
 Ai 16-4664-19
 (Rectum, Vagina)
 19 cm/7 1/2"



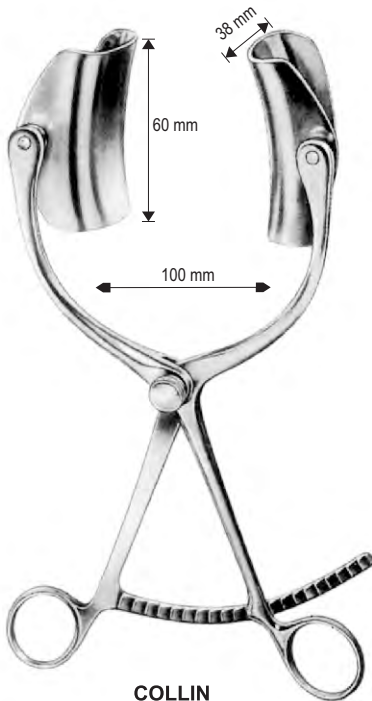
Ai 16-4665-18
 18 cm/7 1/8"



MAYO-ADAMS
 Ai 16-4666-16
 16.5 cm/6 1/2"



BABY-COLLIN complete, with 2 pairs of exchangeable blades
 Ai 16-4667-00



COLLIN
 Ai 16-4668-38



Measurements see below

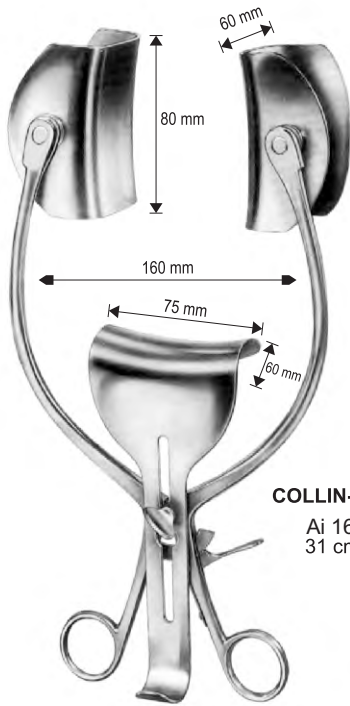
Exchangeable Blades

COLLIN
 Ai 16-4669-38 Lateral Blades 38 x 60 mm / Central Blades 38 x 55 mm
 Ai 16-4670-38 Lateral Blades 38 x 80mm / Central Blades 50 x 75mm



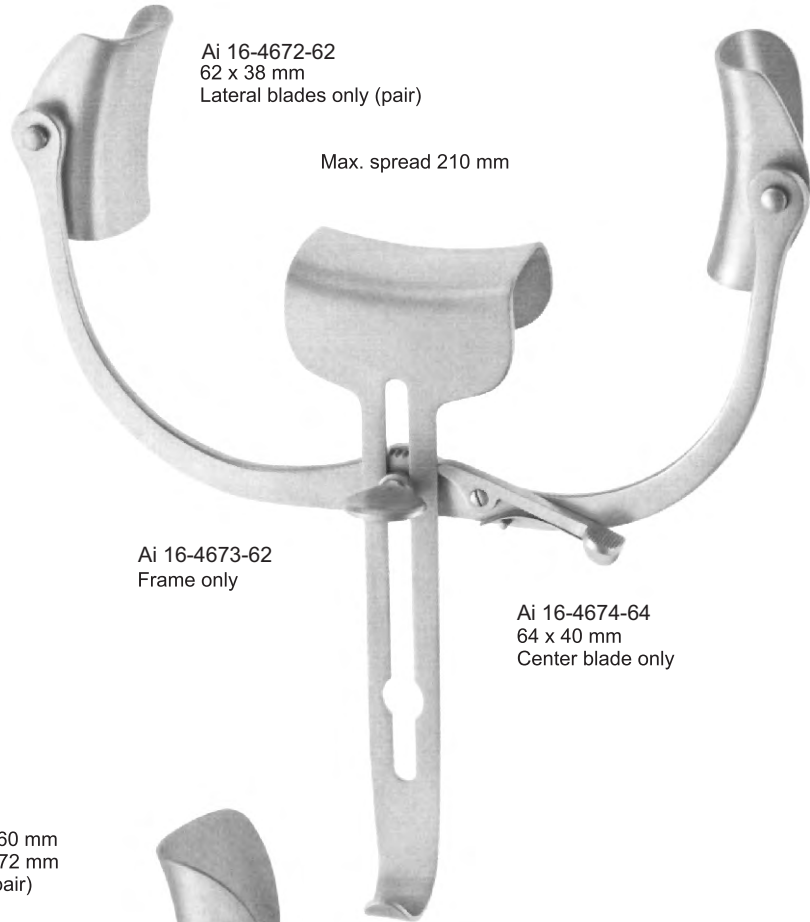
Measurements of retractors: Depth x Width

Exchangeable Blades



COLLIN-LOCKTITE

Ai 16-4671-31
 31 cm 12 1/4"

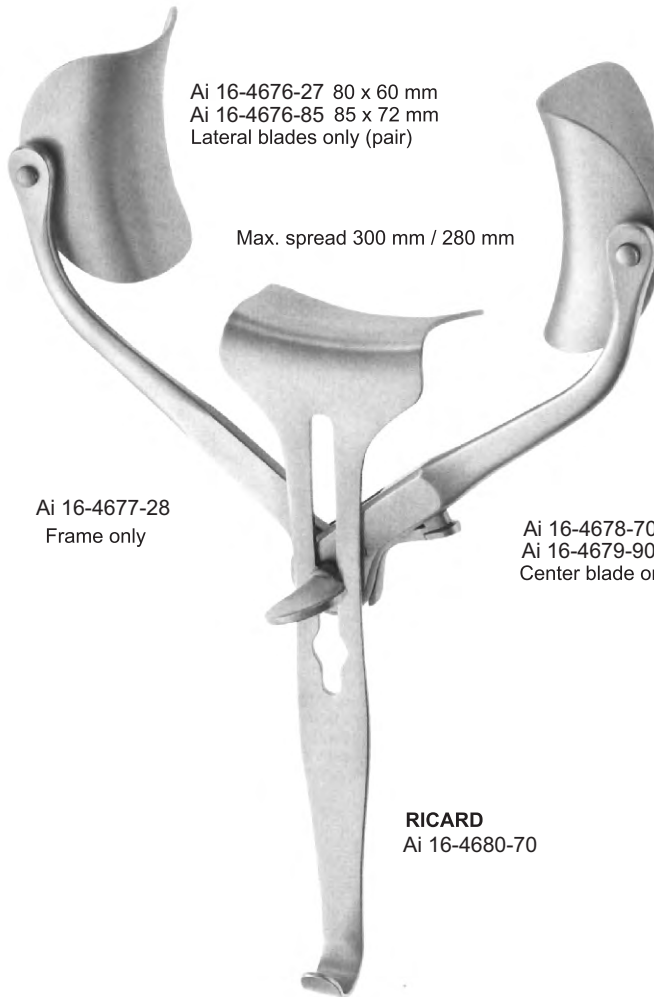


Ai 16-4672-62
 62 x 38 mm
 Lateral blades only (pair)

Max. spread 210 mm

Ai 16-4673-62
 Frame only

Ai 16-4674-64
 64 x 40 mm
 Center blade only



Ai 16-4676-27 80 x 60 mm
 Ai 16-4676-85 85 x 72 mm
 Lateral blades only (pair)

Max. spread 300 mm / 280 mm

Ai 16-4677-28
 Frame only

Ai 16-4678-70 70 x 55 mm
 Ai 16-4679-90 90 x 80 mm
 Center blade only

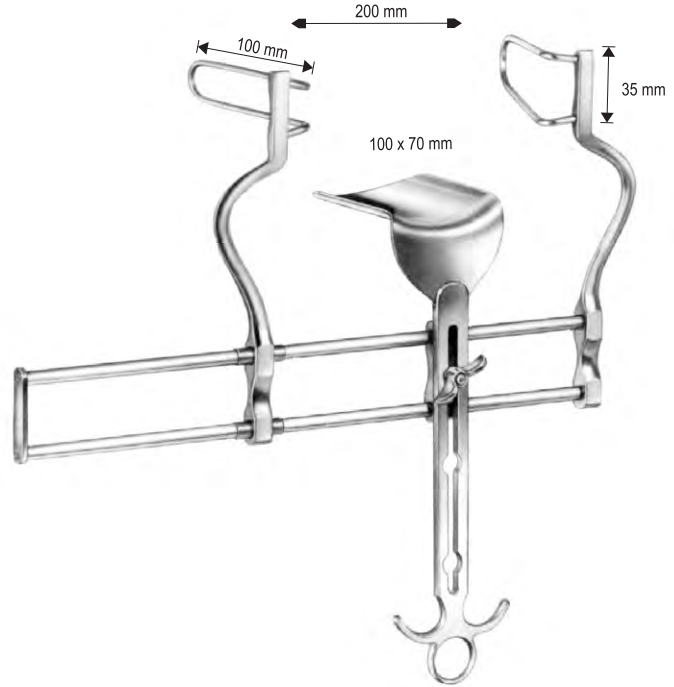
ROBIN-MASSE
 Ai 16-4675-64

RICARD
 Ai 16-4680-70

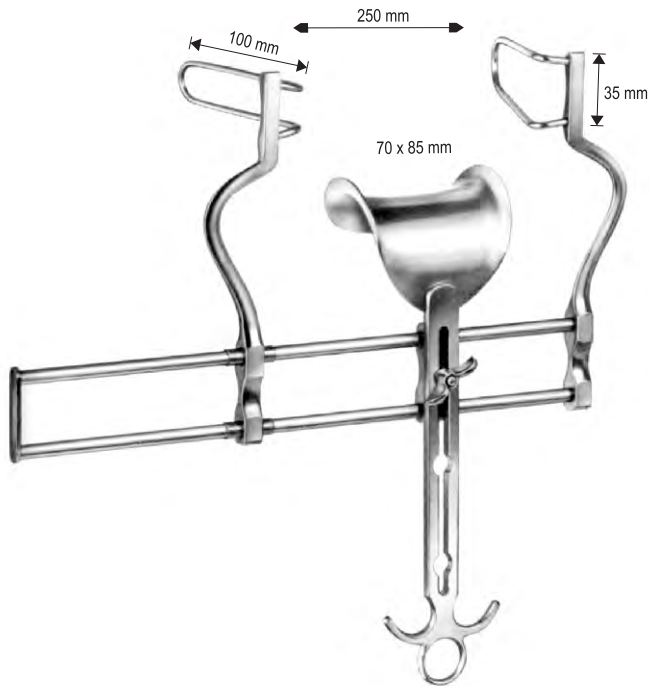
Measurements of retractors: Depth x Width



BALFOUR
 Ai 16-4681-20
 20 cm / 7 7/8"



BALFOUR
 Ai 16-4682-20



BALFOUR
 Ai 16-4683-00

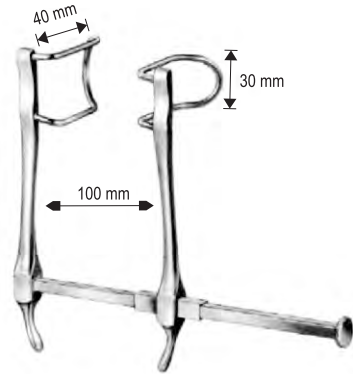
Centre Blade only



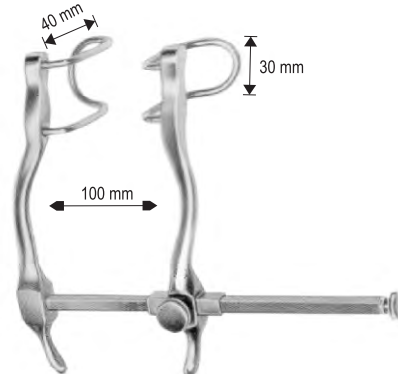
BALFOUR
 Ai 16-4684-45 = 45 X 80 mm
 Ai 16-4684-70 = 70 X 85 mm
 Ai 16-4684-80 = 80 X 90 mm

Measurements of retractors: Depth x Width

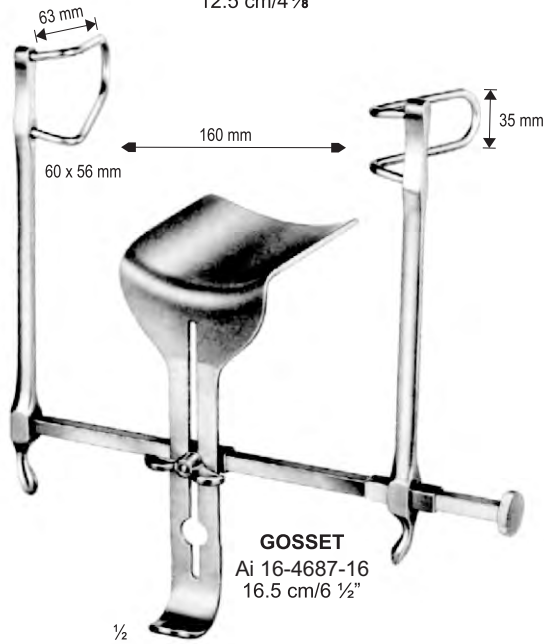




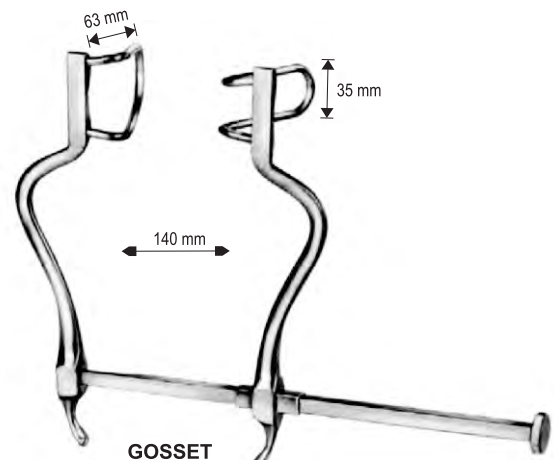
GOSSET-BABY
 Ai 16-4685-12
 12.5 cm/4 7/8"



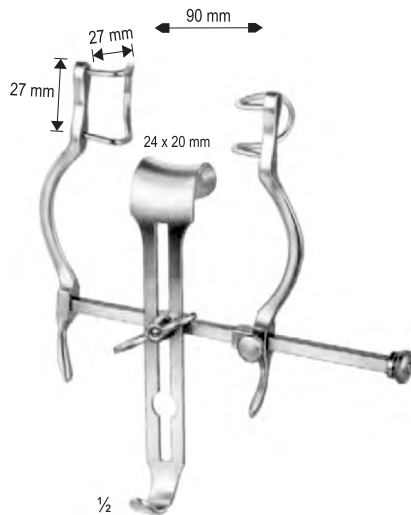
GOSSET
 Ai 16-4686-12



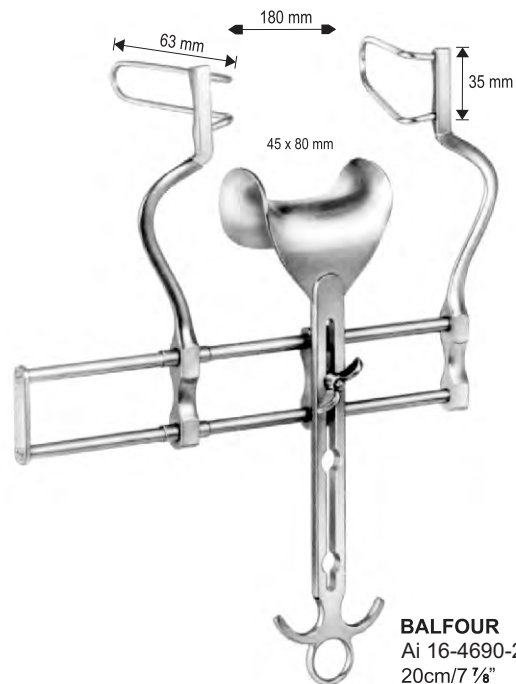
GOSSET
 Ai 16-4687-16
 16.5 cm/6 1/2"



GOSSET
 Ai 16-4688-18
 18.5cm/7 1/4"



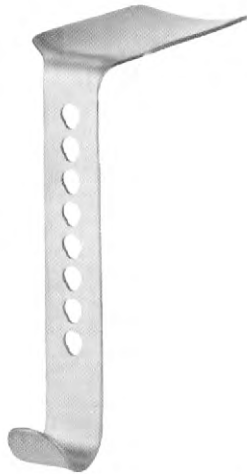
BALFOUR-BABY
 Ai 16-4689-12
 12.5cm/4 7/8"



BALFOUR
 Ai 16-4690-20
 20cm/7 7/8"

Measurements of retractors: Depth x Width

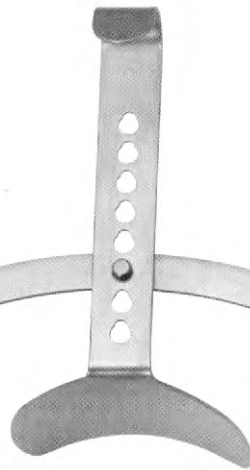
Ai 16-4691-50 50 x 98 mm



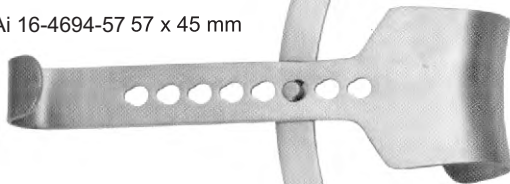
Ai 16-4693-35 35 x 105 mm



Ai 16-4692-94 94 x 83 mm



Ai 16-4694-57 57 x 45 mm



Ai 16-4695-57 57 x 45 mm

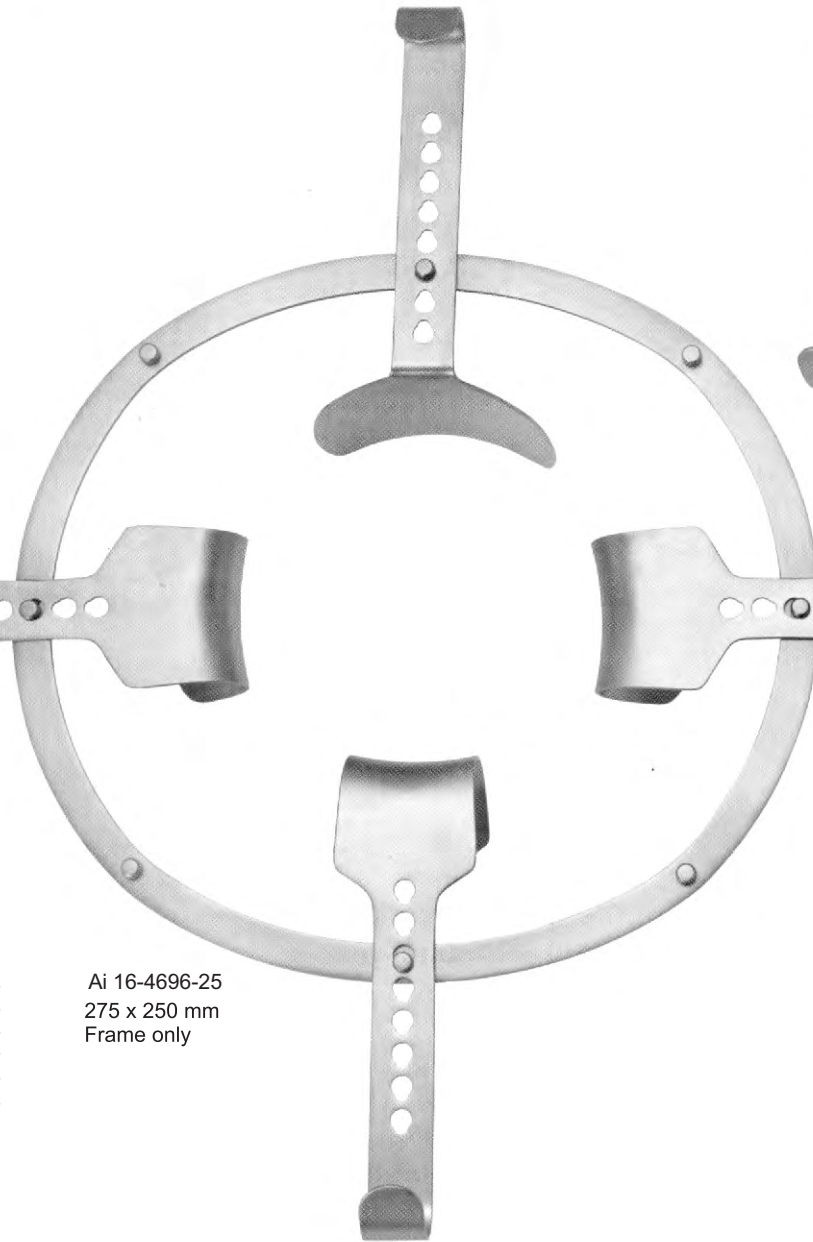


SEMM

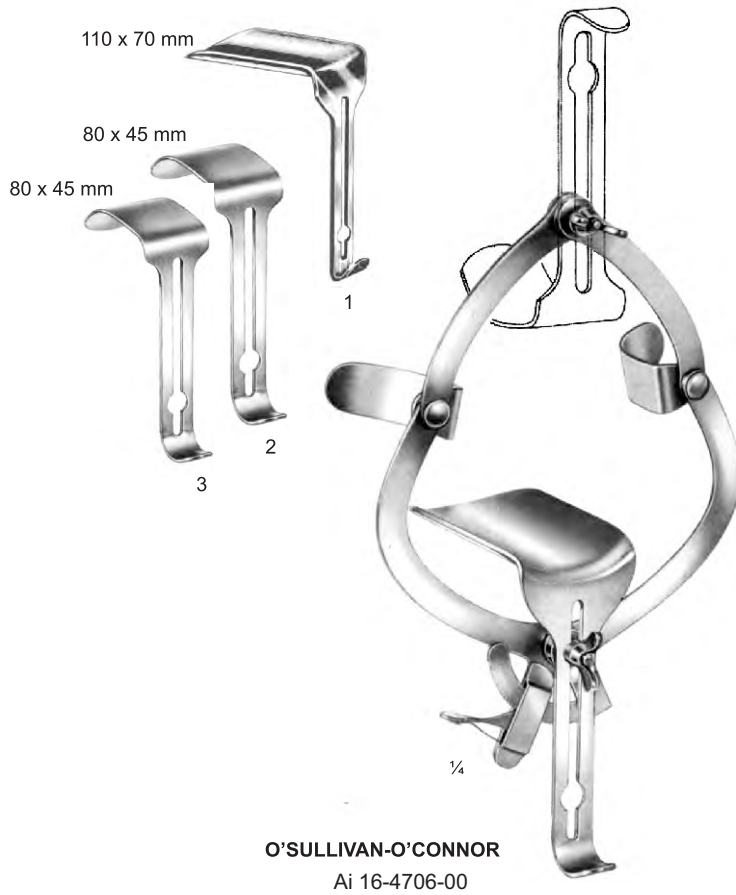
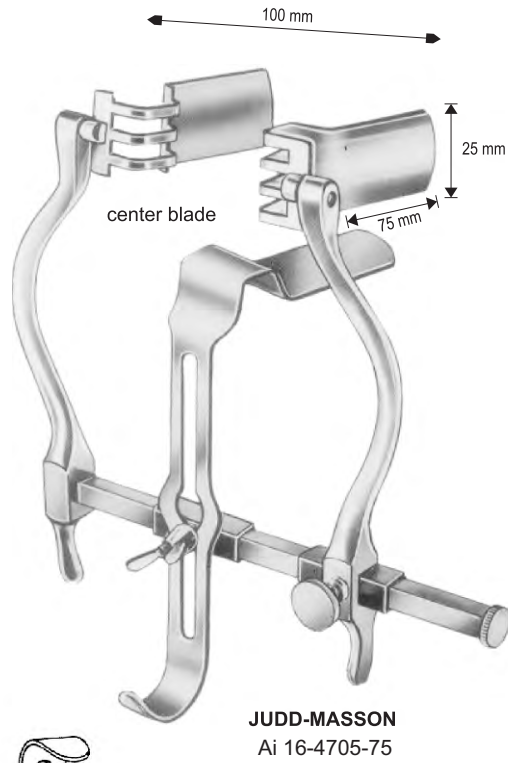
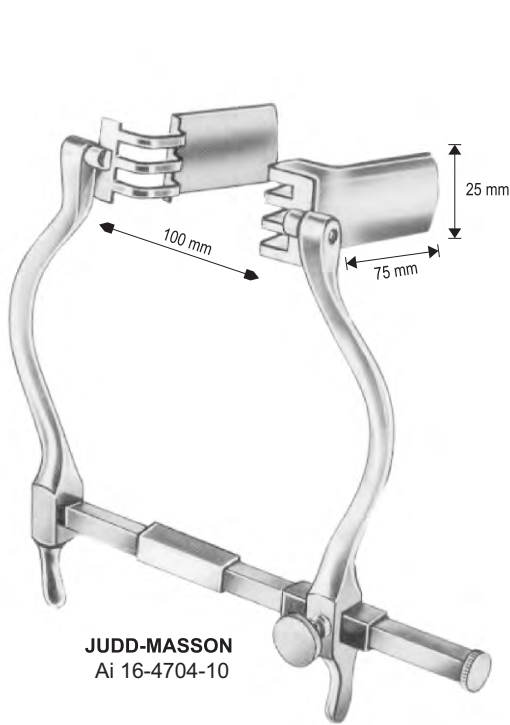
- Ai 16-4648-57
- Complete
- 1 x Ai 16-4698-57
- 2 x Ai 16-4699-57
- 1 x Ai 16-4700-57
- 1 x Ai 16-4701-57
- 1 x Ai 16-4702-57
- 1 x Ai 16-4703-57

Ai 16-4696-25
 275 x 250 mm
 Frame only

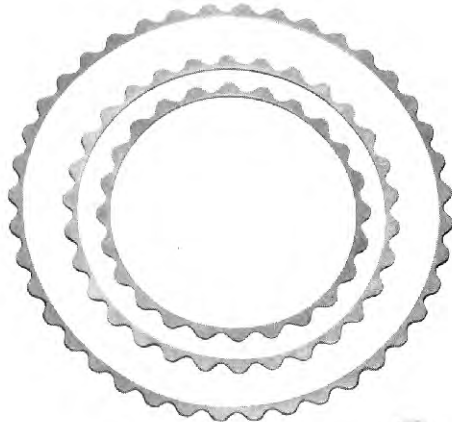
Ai 16-4697-54 54 x 50 mm



Measurements of retractors: Depth x Width



Measurements of retractors: Depth x Width

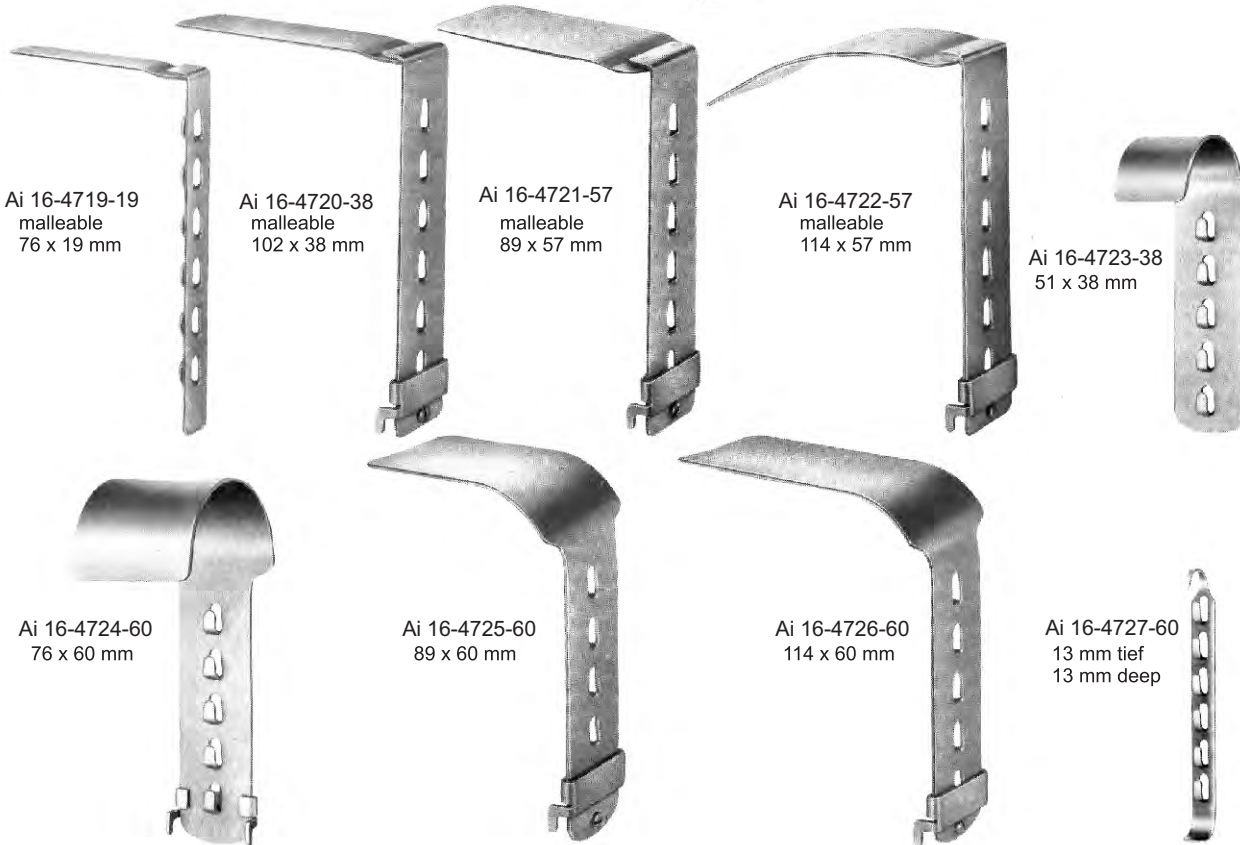


TURNER-WARWICK
 Ai 16-4712-33
 Retractor frame, oval
 457 x 330 mm

TURNER-WARWICK
 Retractor frame, round
 Ai 16-4711-18 Ø 18 cm/7 1/8"
 Ai 16-4711-23 Ø 23cm/9"
 Ai 16-4711-30 Ø 30.5cm/12"



TURNER-WARWICK
 Ai 16-4713-33
 Abdominal retractor, complete
 consisting of
 1 frame Ai 16-4714-33
 2 retractor blades of eac Ai 16-4715-33
 2 abdominal retractor of each Ai 16-4716-33
 2 abdominal retractor of each Ai 16-4717-33
 2 retractor blade single hooks Ai 16-4718-33



Ai 16-4719-19
 malleable
 76 x 19 mm

Ai 16-4720-38
 malleable
 102 x 38 mm

Ai 16-4721-57
 malleable
 89 x 57 mm

Ai 16-4722-57
 malleable
 114 x 57 mm

Ai 16-4723-38
 51 x 38 mm

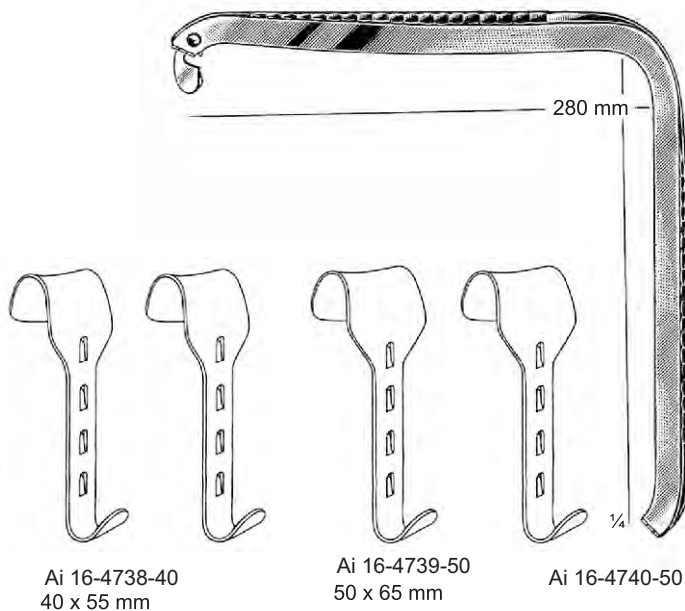
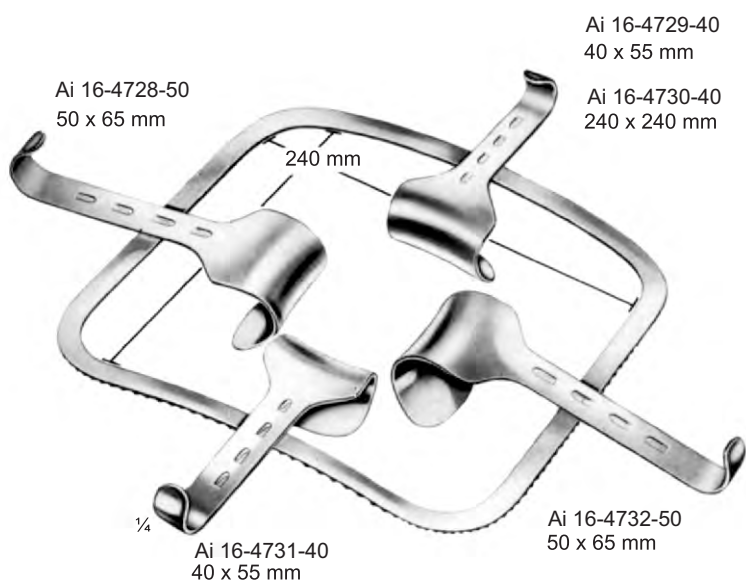
Ai 16-4724-60
 76 x 60 mm

Ai 16-4725-60
 89 x 60 mm

Ai 16-4726-60
 114 x 60 mm

Ai 16-4727-60
 13 mm tief
 13 mm deep





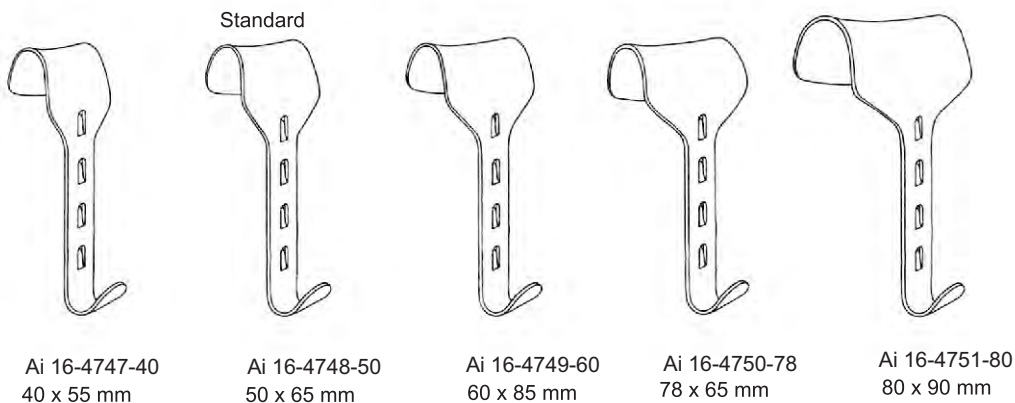
KIRSCHNER
 Ai 16-4733-00

- Ai 16-4734-00 - Kirschner, Abdominal Retractor - complete, consisting of:
- Ai 16-4735-00 - 2 Hook-on retractors, 40 x 55 mm
- Ai 16-4736-00 - 2 ditto, 50 x 65 mm
- Ai 16-44737-00 - Frame only, rigid, 240 x 240 mm

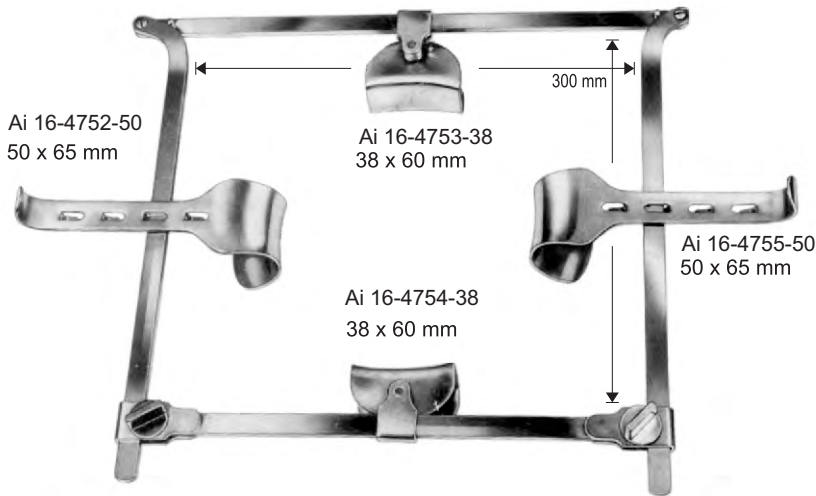
KIRSCHNER
 Ai 16-4741-00

- Ai 16-4742-00 - Kirschner, Abdominal Retractor, folding, - large size, complete, consisting of:
- Ai 16-4743-00 - 1 Frame folding type, large size - 280 x 280 mm
- Ai 16-4744-00 - 2 Hook-on retractors, 40 x 55 mm
- Ai 16-4745-00 - 2 ditto, 50 x 65 mm
- Ai 16-4746-00 - Frame only, folding type 280 x 280 mm

Hook-on Retractors for Kirschner and Franz Frames



Measurements of retractors: Depth x Width



FRANZ (Complete)

Ai 16-4756-38 with 4 blades Ai 16-4757-38 with 8 blades



Ai 16-4758-30
300 x 300 mm

Folding frame

Ai 16-4759-45
45 x 80 mm



Ai 16-4760-60
60 x 85 mm



Ai 16-4761-60
60 x 85 mm

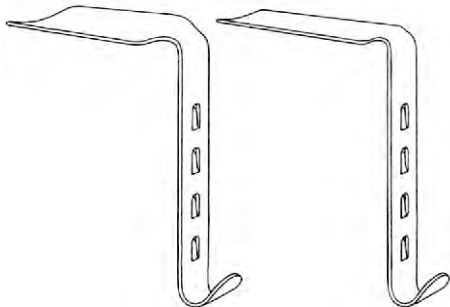


Ai 16-4762-45
45 x 80 mm

- Ai 16-4763-50 - Franz, Abdominal Retractor, folding, - complete, consisting of:
- Ai 16-4764-50 - 2 Hook-on retractors, 50 x 65 mm
- Ai 16-4765-50 - 2 exchangeable blades 38 x 60 mm
- Ai 16-4766-50 - Frame, folding, only, 300 x 300 mm

- Ai 16-4767-30 - Franz, Abdominal Retractor, folding, - complete, consisting of:
- Ai 16-4768-30 - 1 Frame folding, 300 x 300 mm
- Ai 16-4769-30 - 2 Hook-on retractors, 50 x 65 mm
- Ai 16-4770-30 - 2 ditto, 60 x 85 mm
- Ai 16-4771-30 - 2 exchangeable blades 38 x 60 mm
- Ai 16-4772-30 - 2 ditto, 45 x 80 mm

Intestinal and bladder



Ai 16-4773-98
98 x 50 mm

Ai 16-4774-35
105 x 35 mm

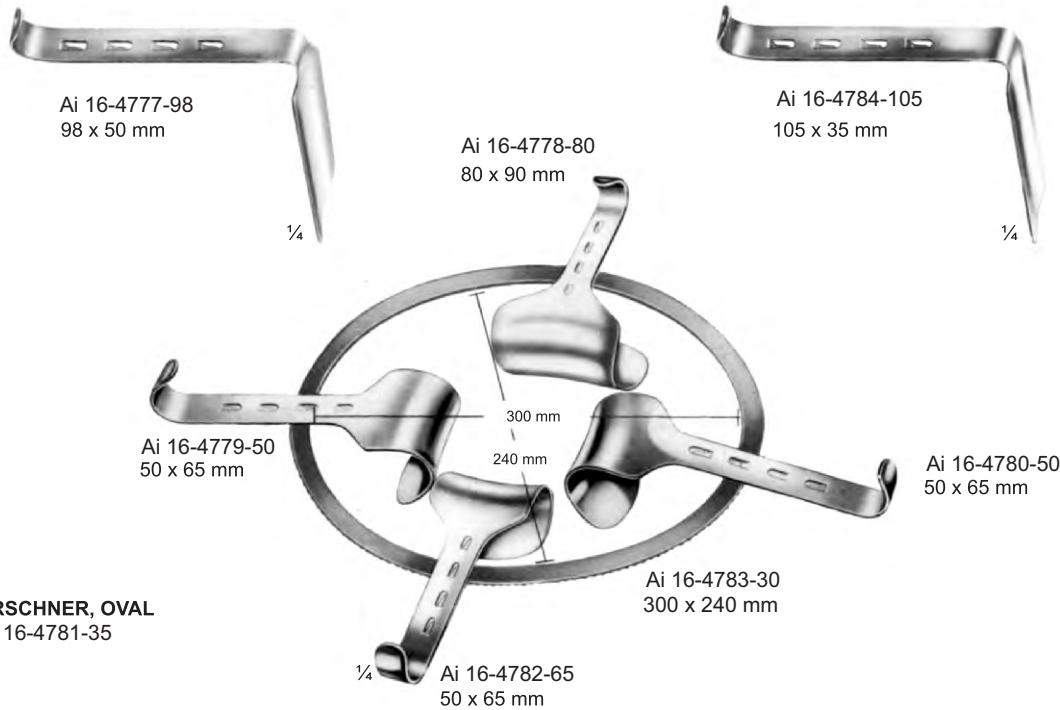


Ai 16-4775-38
38 x 60 mm



Ai 16-4776-45
45 x 80 mm

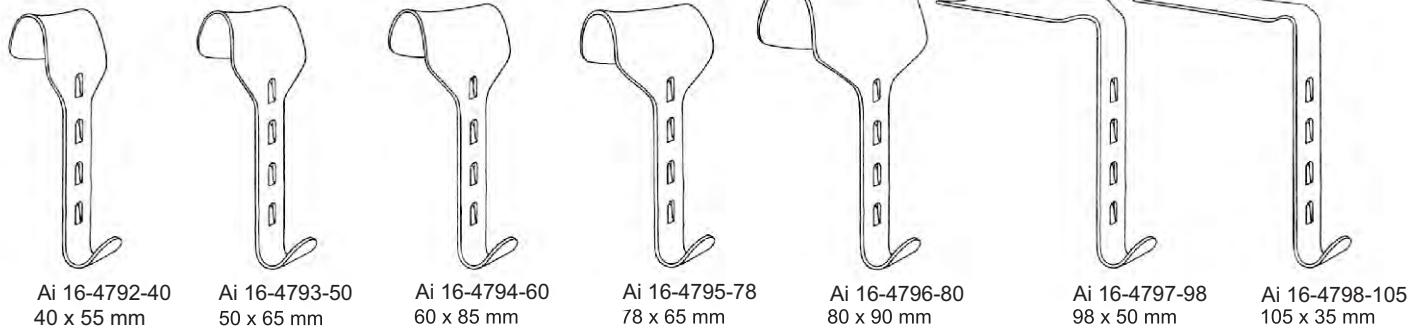




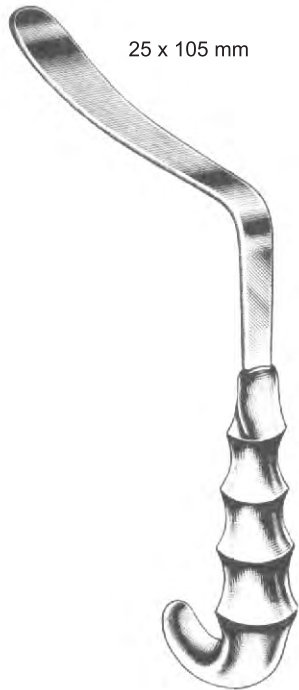
KIRSCHNER, OVAL
 Ai 16-4781-35

- Ai 16-4785-50 - Kirschner, Abdominal Retractor, Oval, complete, consisting of:
 - Ai 16-4786-50 - 1 Frame, 300 x 240 mm
 - Ai 16-4787-50 - 3 Hook-on retractors, 50 x 65 mm
 - Ai 16-4788-50 - 1 ditto, 80 x 90 mm
 - Ai 16-4789-50 - 1 ditto, 98 x 50 mm
 - Ai 16-4790-50 - 1 ditto, 105 x 35 mm
 - Ai 16-4791-50 - Frame only, 300 x 240 mm
- Hook-on retractors see bottom of page

Hook-on Retractors for Kirschner and Franz Frames



Measurements of retractors: Depth x Width



25 x 105 mm

LEGUEU
 Ai 16-4799-25
 25 cm/9 7/8"



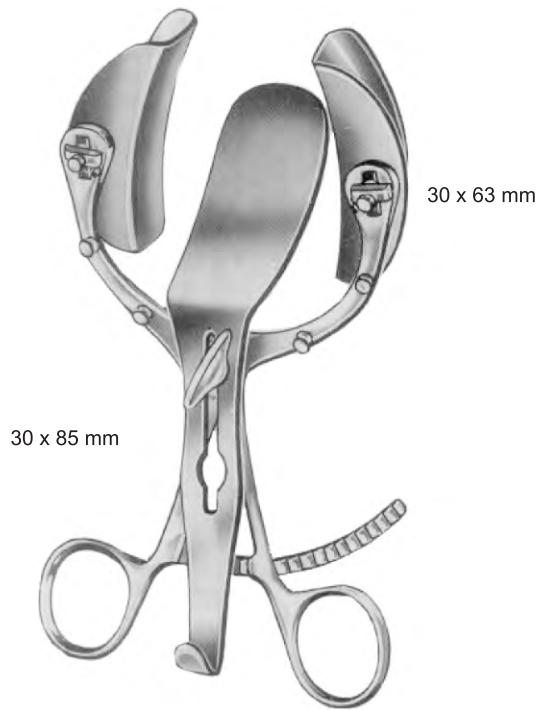
67 x 105 mm

KOCHER
 Ai 16-4800-26
 26 cm/10 1/4"



56 x 105 mm

KOCHER
 Ai 16-4801-26
 26 cm/10 1/4"

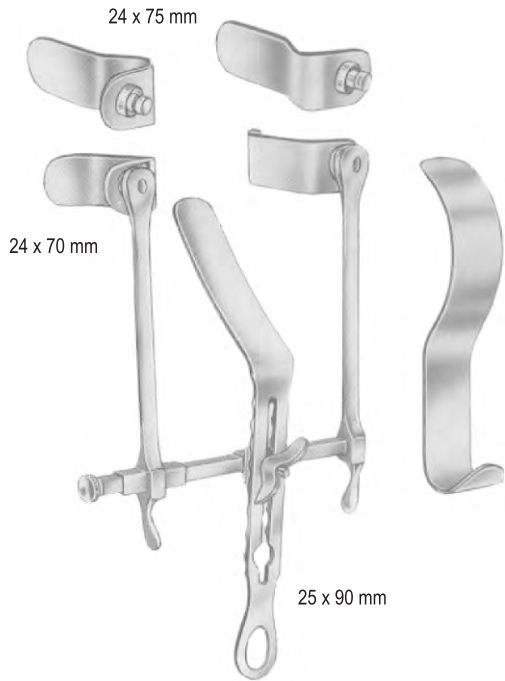


30 x 85 mm

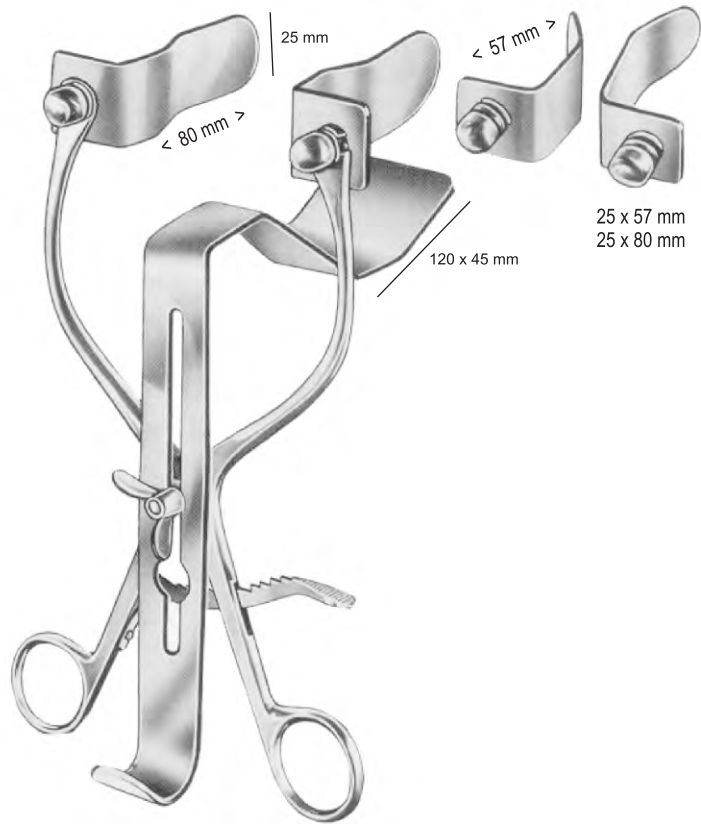
30 x 63 mm

LEGUEU
 Ai 16-4802-30





THOMSON-WALKER
 Ai 16-4803-25



MILLIN
 Ai 16-4804-25

Measurements of retractors: Depth x Width

EN Suture

DE Naht

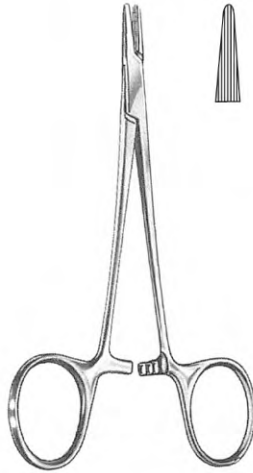
ES Sutura

Page 346 to 372

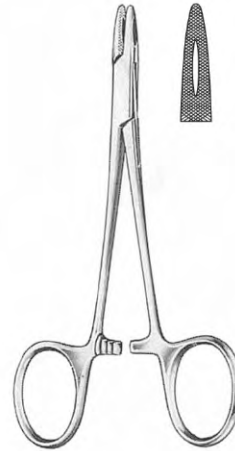




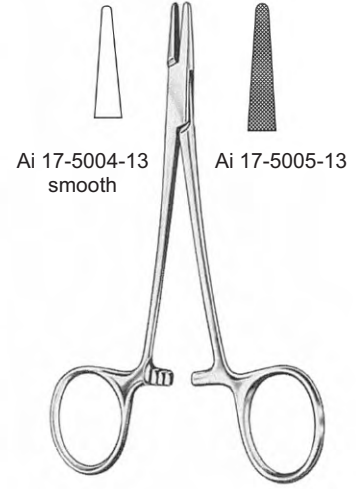
Derf
 Ai 17-5001-12 12.0cm



Derf
 Ai 17-5002-12 12.5cm



Collier
 Ai 17-5003-12 12.5cm

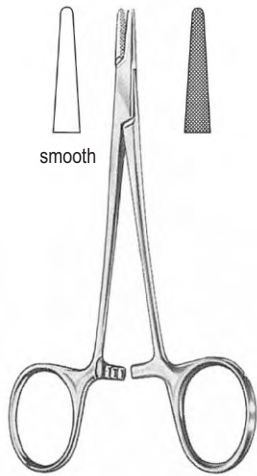


Ai 17-5004-13 smooth
 Ai 17-5005-13

Webster
 13.0cm

Nadelhalter

smooth jaws with special groove



smooth

Halsey
 Ai 17-5006-13 13.0cm Ai 17-5007-13



Neivert
 Ai 17-5008-13 13.0cm



Hegar-Baumgartner
 Ai 17-5009-12 12.5cm
 Ai 17-5009-14 14.0cm



Brown
 Ai 17-5010-13 13.0cm
 Ai 17-5010-18 18.0cm



Mayo-Hegar

- | | | |
|---------------|--------|---------------|
| Ai 17-5011-14 | 14.0cm | Ai 17-5012-14 |
| Ai 17-5011-15 | 15.0cm | Ai 17-5012-15 |
| Ai 17-5011-16 | 16.0cm | Ai 17-5012-16 |
| Ai 17-5011-18 | 18.0cm | Ai 17-5012-18 |
| Ai 17-5011-20 | 20.0cm | Ai 17-5012-20 |
| Ai 17-5011-22 | 22.0cm | Ai 17-5012-22 |
| Ai 17-5011-24 | 24.0cm | Ai 17-5012-24 |
| Ai 17-5011-26 | 26.0cm | Ai 17-5012-26 |
| Ai 17-5011-28 | 28.0cm | Ai 17-5012-28 |
| Ai 17-5011-30 | 30.0cm | Ai 17-5012-30 |



delicate pattern

Mayo-Hegar

- | | |
|---------------|--------|
| Ai 17-5013-16 | 16.0cm |
| Ai 17-5013-18 | 18.0cm |
| Ai 17-5013-20 | 20.0cm |



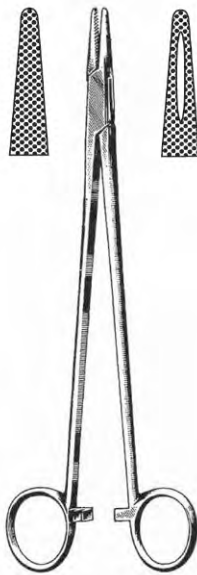
Crile-Murray

- | | |
|---------------|--------|
| Ai 17-5014-15 | 15.0cm |
|---------------|--------|



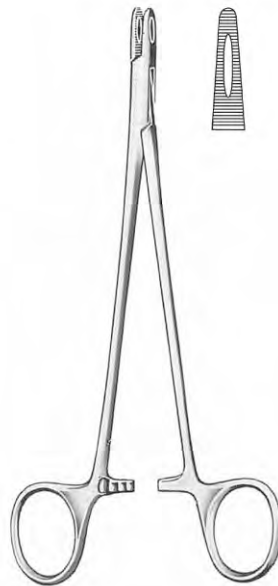
Crile-Wood

- | | |
|---------------|--------|
| Ai 17-5015-15 | 15.0cm |
| Ai 17-5015-18 | 18.0cm |
| Ai 17-5015-20 | 20.0cm |



Hegar

- | | | |
|---------------|--------|---------------|
| Ai 17-5016-20 | 20.0cm | Ai 17-5017-20 |
| Ai 17-5016-24 | 24.0cm | Ai 17-5017-24 |



Adson

- | | |
|---------------|--------|
| Ai 17-5018-18 | 18.0cm |
|---------------|--------|



Heaney

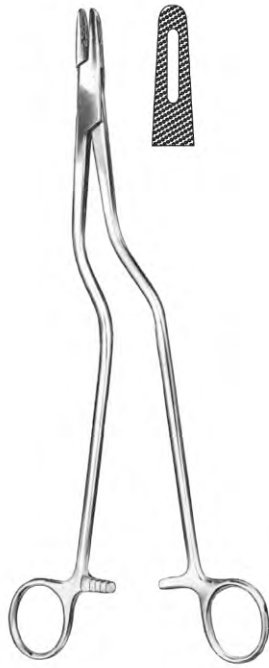
- | | |
|---------------|--------|
| Ai 17-5019-21 | 21.0cm |
|---------------|--------|



Metzenbaum

- | | |
|---------------|--------|
| Ai 17-5020-18 | 18.0cm |
|---------------|--------|

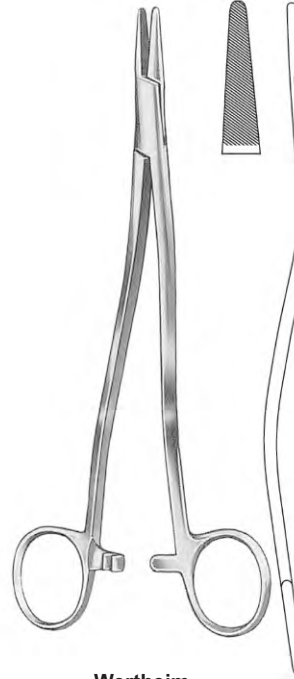




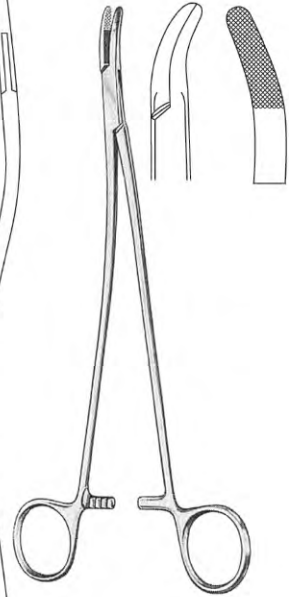
Masson-Luethy
 Ai 17-5021-26
 26.0cm



Sarot
 Ai 17-5022-18 18.0cm
 Ai 17-5022-26 26.0cm



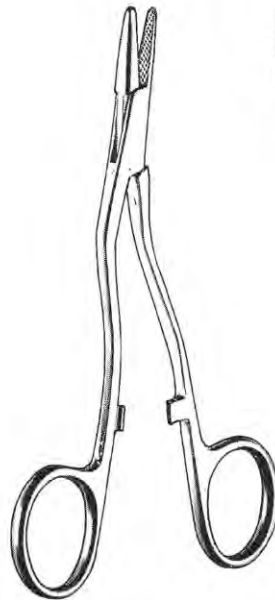
Wertheim
 Ai 17-5023-20 20.0cm
 Ai 17-5023-24 24.0cm



Stratte
 Ai 17-5024-23
 23.0cm



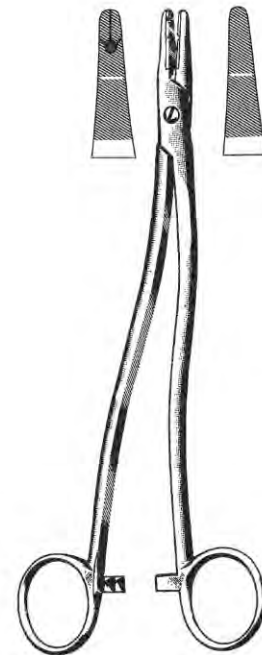
Bruce-Clarke
 Ai 17-5025-12
 12.5cm



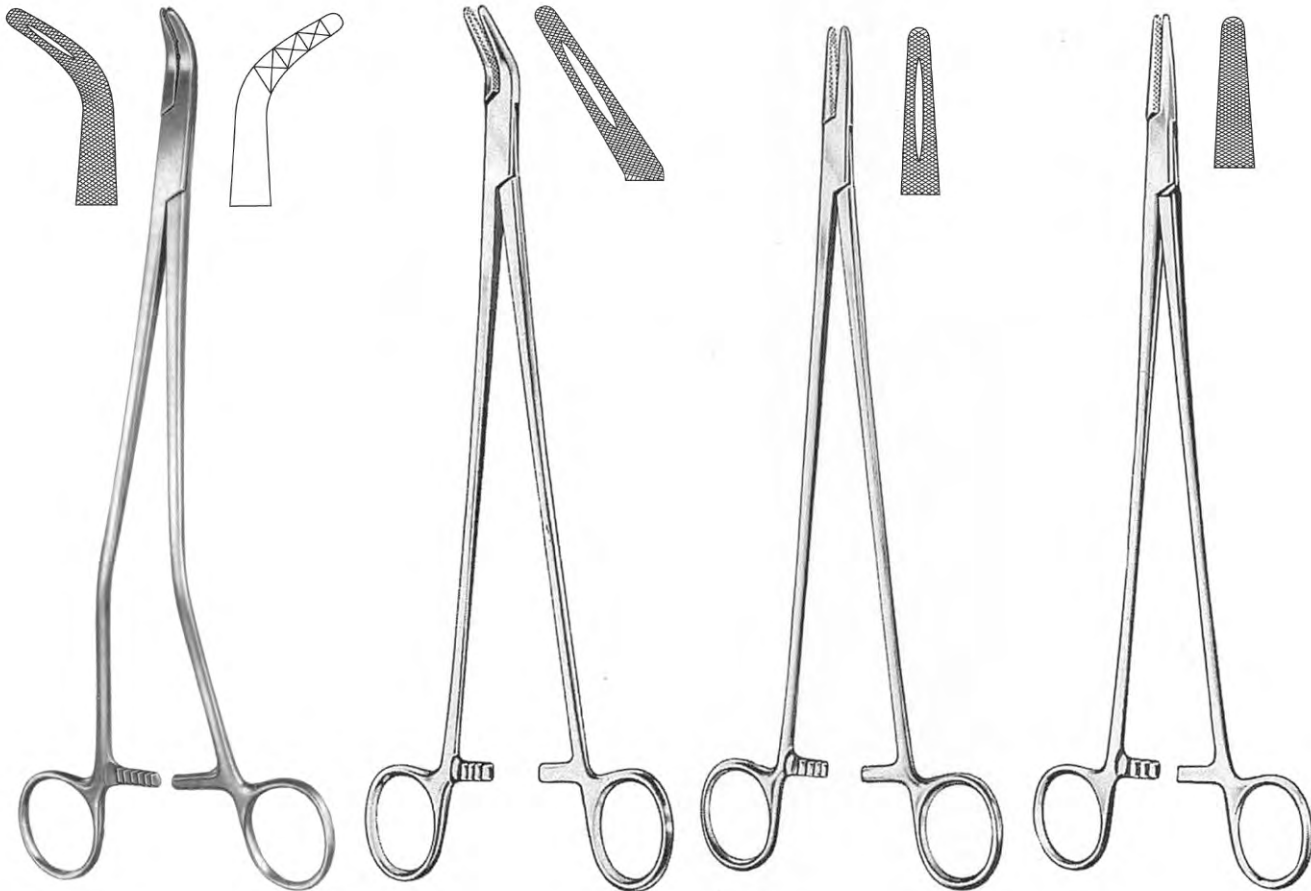
Kilner
 Ai 17-5026-13 13.5cm
 Ai 17-5026-16 16.5cm



Thomson-Walker
 Ai 17-5027-20
 20.0cm



Bozemann
 Ai 17-5028-20 20.0cm
 Ai 17-5028-24 24.0cm



Johnson
 Ai 17-5029-27
 27.0cm

Finocchietto
 Ai 17-5030-18 18.0cm
 Ai 17-5030-20 20.0cm
 Ai 17-5030-27 27.0cm

Masson
 Ai 17-5031-27
 27.0cm

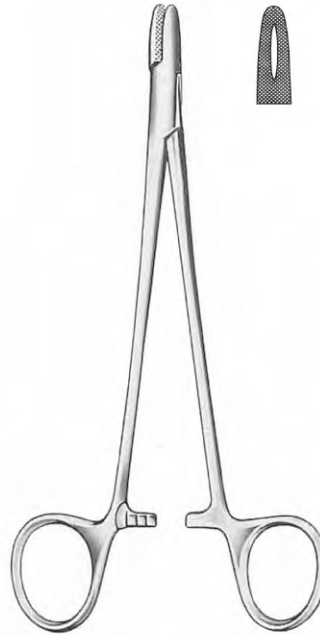
Wangensteen
 Ai 17-5032-27
 27.0cm



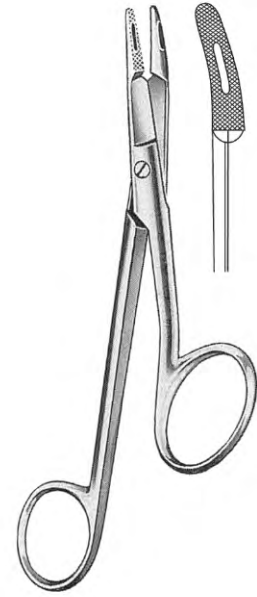
Wangensteen
Ai 17-5033-27 27.0cm



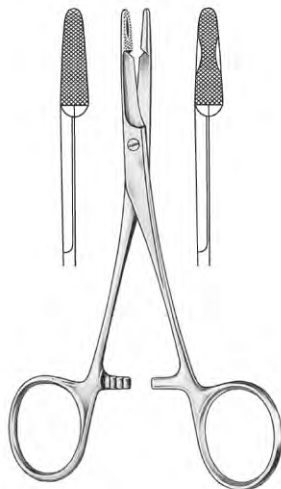
Jamison
Ai 17-5034-23 23.5cm



M.G.H.(mass-general-hospital)
Ai 17-5035-17 17.0cm



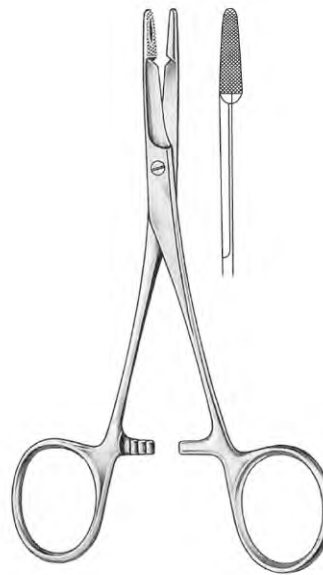
Gillies
Ai 17-5036-16 16.0cm (right hand)
Ai 17-5036-17 16.0cm (left hand)



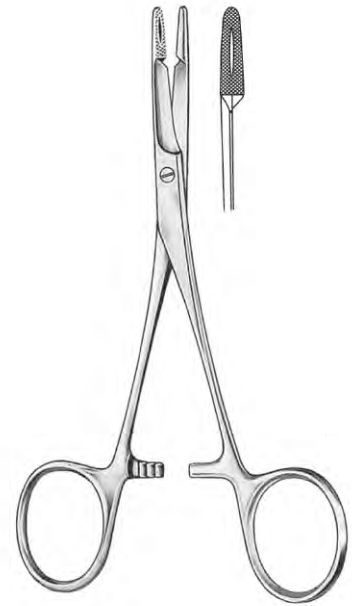
Olsen-Hegar
Ai 17-5037-14 14.0cm Ai 17-5038-14
with blood groove



Olsen-Hegar
Ai 17-5039-17 17.0cm



Olsen-Hegar
Ai 17-5040-17 17.0cm



Olsen-Hegar
Ai 17-5041-14 14.0cm
Ai 17-5041-18 18.0cm



Crile
 Ai 17-5042-15 15.0cm



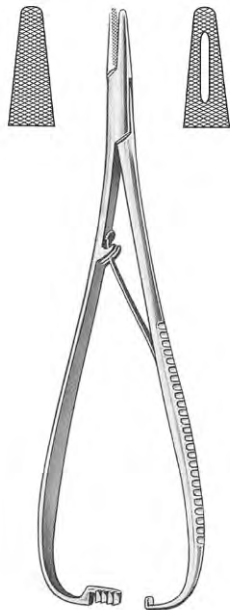
Toennis
 Ai 17-5043-18 18.0cm



Lichtenberg
 Ai 17-5044-20 20.0cm



Macphail
 Ai 17-5045-14 14.0cm
 Ai 17-5045-16 16.0cm
 Ai 17-5045-18 18.0cm
 Ai 17-5045-20 20.0cm



Mathieu
 Ai 17-5046-14 14.0cm Ai 17-5047-14
 Ai 17-5046-17 17.0cm Ai 17-5047-17
 Ai 17-5046-20 20.0cm Ai 17-5047-20
 Ai 17-5046-24 24.0cm Ai 17-5047-24



Delicate
Mathieu
 Ai 17-5048-14 14.0cm
 Ai 17-5048-17 17.0cm

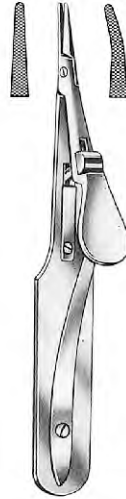


Mathieu
 Ai 17-5049-17 17.0cm
 Ai 17-5049-20 20.0cm





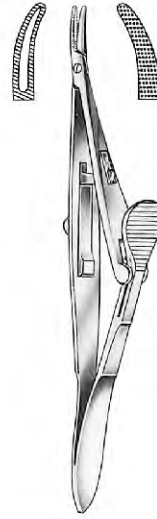
BARRAQUER
 Ai 17-5050-16
 16.0cm



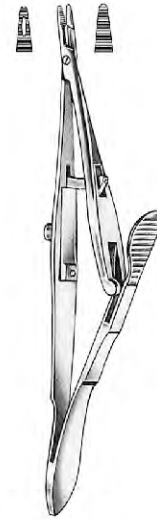
ARRUGA
 Ai 17-5051-14 14.0cm
 Ai 17-5052-14 14.0cm



KALT
 Ai 17-5053-14
 14.0cm



KALT-ARRUGA
 Ai 17-5054-14
 14.0cm



CASTROVIEJO-KALT
 Ai 17-5055-13
 13.5cm



BOYNTON
 Ai 17-5056-12
 12.0cm



ARRUGA
 Ai 17-5057-16 16.0cm
 Ai 17-5058-16 16.0cm



STEVENSON
 Ai 17-5059-11
 11.0cm



STEVENS
 Ai 17-5060-13 13.0cm
 Ai 17-5060-15 15.0cm



WECKER
 Ai 17-5061-15
 15.0cm



BARRAQUER
 Ai 17-5062-14
 14.0cm



CASTROVIEJO
Ai 17-5063-09
9.0cm



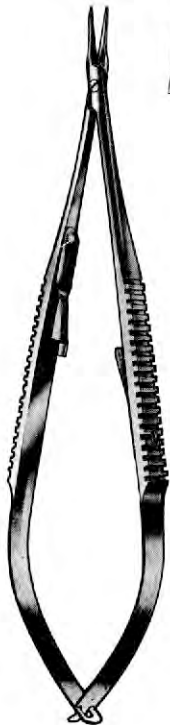
CASTROVIEJO
Ai 17-5064-09
9.0cm



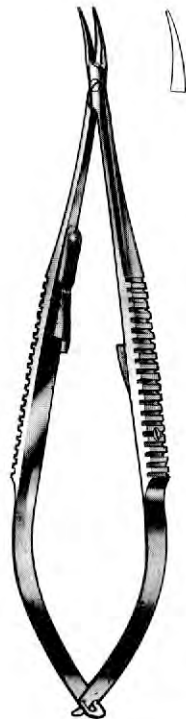
CASTROVIEJO
Ai 17-5065-09
9.0cm



CASTROVIEJO
Ai 17-5066-09
9.0cm



CASTROVIEJO
Ai 17-5067-14
14.0cm



CASTROVIEJO
Ai 17-5068-14
14.0cm



BARRAQUER
Ai 17-5069-10
10.0cm



BARRAQUER
Ai 17-5070-10
10.0cm

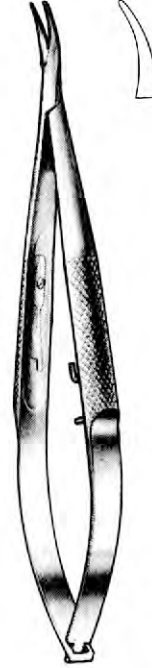




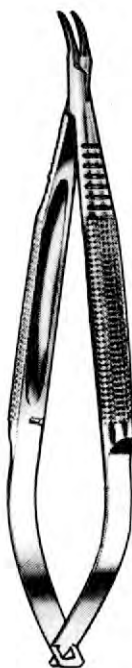
BARRAQUER-TROUTMAN
 Ai 17-5071-10
 10.0cm



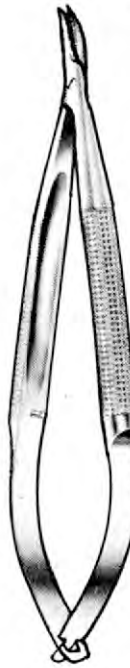
BARRAQUER-TROUTMAN
 Ai 17-5072-10
 10.0cm



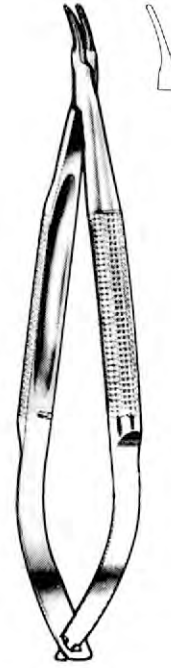
BARRAQUER
 Ai 17-5073-14
 14.0cm



BARRAQUER
 Ai 17-5074-13
 13.0cm



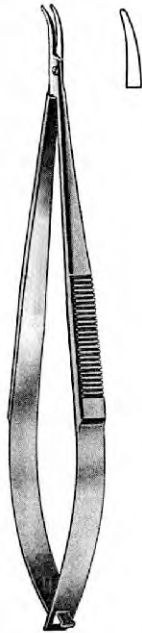
BARRAQUER
 Ai 17-5075-11
 11.0cm



BARRAQUER
 Ai 17-5076-13
 13.0cm



CASTROVIEJO
Ai 17-5077-14 14.0cm
Ai 17-5077-17 17.0cm



CASTROVIEJO
Ai 17-5078-14 14.0cm
Ai 17-5078-17 17.0cm



CASTROVIEJO
Ai 17-5079-14 14.0cm
Ai 17-5079-17 17.0cm



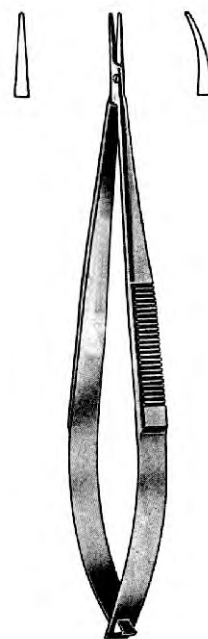
CASTROVIEJO
Ai 17-5080-14 14.0cm
Ai 17-5080-17 17.0cm



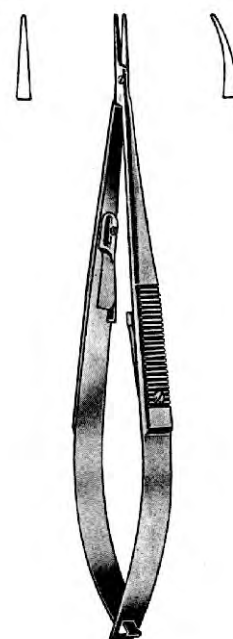
JACOBSON
Ai 17-5081-18 18.5cm
Ai 17-5081-21 21.0cm



JACOBSON
Ai 17-5082-18 18.5cm
Ai 17-5082-21 21.0cm



CASTROVIEJO
Ai 17-5083-01 10.0cm
Ai 17-5083-02 10.0cm



CASTROVIEJO
Ai 17-5084-01 10.0cm
Ai 17-5084-02 10.0cm





Ai 17-5085-16
16.0cm



Ai 17-5086-01 23.0cm Fig.1
 Ai 17-5086-02 23.0cm Fig.2
 Ai 17-5086-03 19.0cm Fig.3



CASTROVIEJO-BARRAQUER
 Ai 17-5087-12
 12.0cm



CASTROVIEJO
 Ai 17-5088-13
 13.0cm



CASTROVIEJO
 Ai 17-5089-12
 12.0cm



REVERDIN
14.0cm



Fig.1
Ai 17-5090-01



Fig.2
Ai 17-5090-02



Fig.3
Ai 17-5090-03



Fig.4
Ai 17-5090-04



REVERDIN
19.0cm
21.0cm



REVERDIN
23.0cm



Fig.1
Ai 17-5091-01
Ai 17-5092-01
Ai 17-5093-01



Fig.2
Ai 17-5091-02
Ai 17-5092-02
Ai 17-5093-02



Fig.3
Ai 17-5091-03
Ai 17-5092-03
Ai 17-5093-03



Fig.4
Ai 17-5091-04
Ai 17-5092-04
Ai 17-5093-04





Ai 17-5094-20 20.0cm
 Ai 17-5095-20 20.0cm



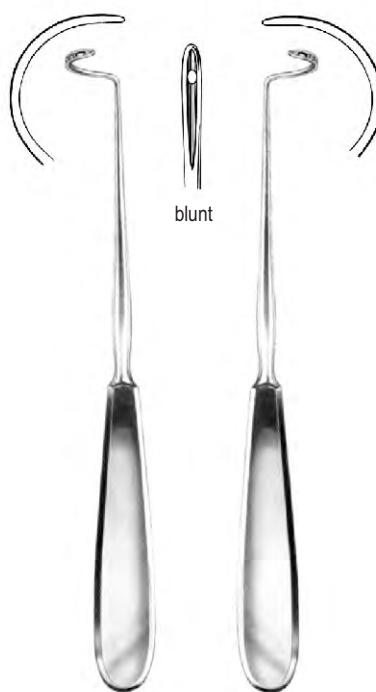
Ai 17-5096-20 20.0cm
 Ai 17-5097-20 20.0cm



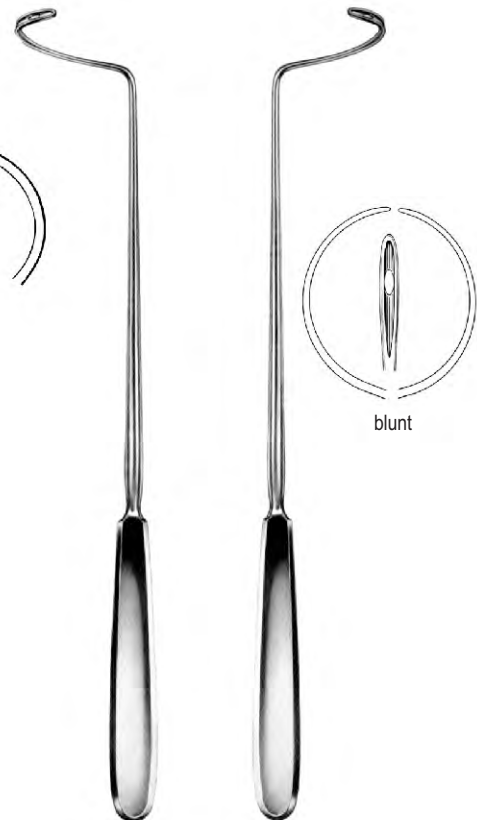
Ai 17-5098-20 20.0cm
 Ai 17-5099-20 20.0cm



DESCHAMPS
 Ai 17-5100-21 21.0cm
 Ai 17-5101-21 21.0cm



DESCHAMPS
 Ai 17-5102-21 21.0cm
 Ai 17-5103-21 21.0cm



DESCHAMPS
 Ai 17-5104-28 28.0cm
 Ai 17-5105-28 28.0cm



SCHMIEDEN-DICK
 Ai 17-5106-32
 32.0cm



SCHMIEDEN
 Ai 17-5107-21
 21.0cm



COOPER
 Ai 17-5108-20
 20.0cm



YOUNG
 Ai 17-5109-19
 19.0cm



YOUNG
 Ai 17-5111-25
 25.0cm
 with 3 needles.



Ai 17-5111-01

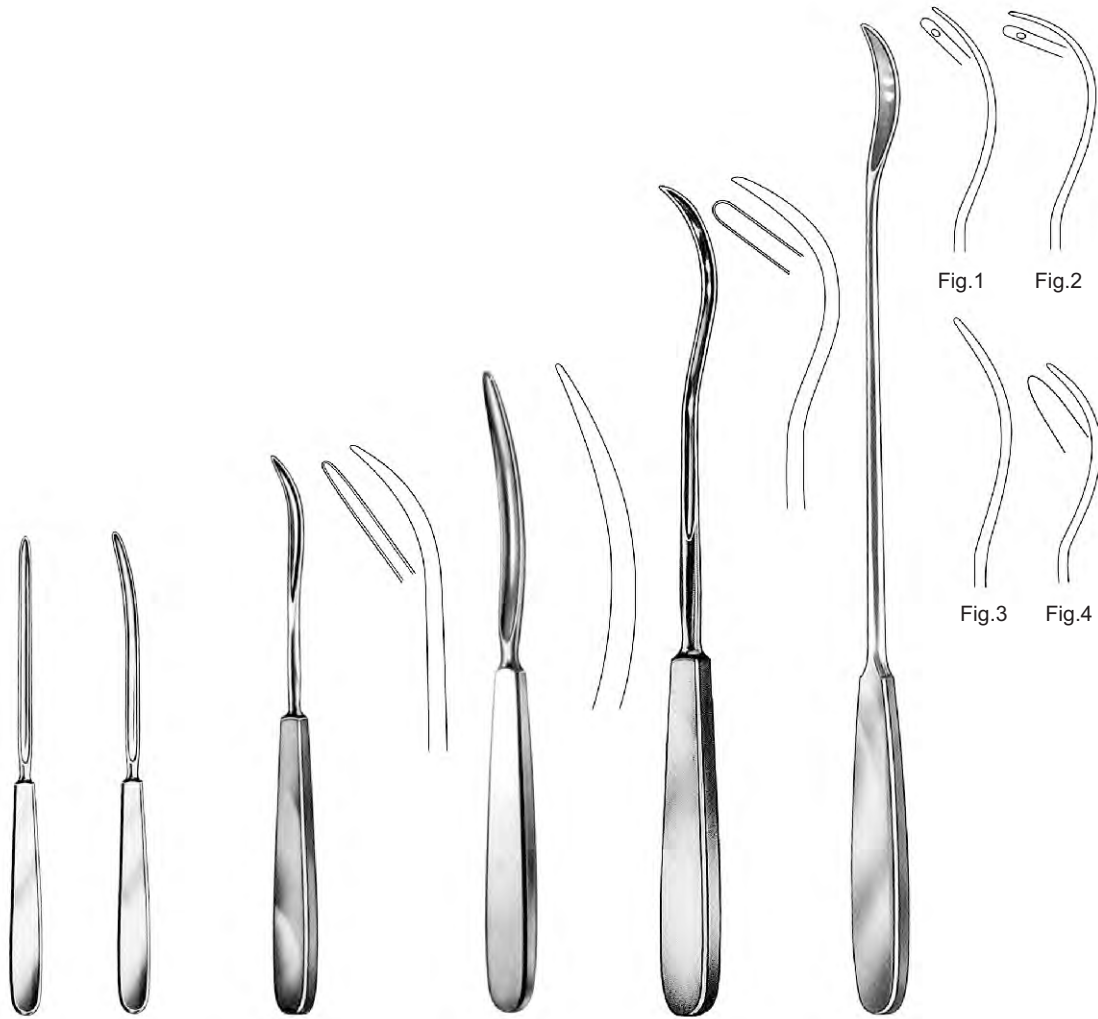


Ai 17-5111-02



Ai 17-5111-03





PAYR
 22.0cm
 Ai 17-5112-22
 Ai 17-5113-22

KÖNIG
 Ai 17-5114-03 19.5cm
 Ai 17-5114-05 19.5cm
 Ai 17-5114-07 20.0cm

MOD
 Ai 17-5115-19
 19.0cm

KIRSCHNER
 Ai 17-5116-25
 25.0cm

BRUNNER
 30.0cm
 Ai 17-5117-01 Fig.1
 Ai 17-5117-02 Fig.2
 Ai 17-5117-03 Fig.3
 Ai 17-5117-04 Fig.4



MICHEL
 Ai 17-5118-12
 12.0cm



MICHEL
 Ai 17-5119-12
 12.0cm



WACHENFELDT
 Ai 17-5120-12
 12.5cm



WACHENFELDT
 Ai 17-5121-12
 12.0cm



WACHENFELDT
 Ai 17-5122-12
 12.5cm



HEGENBARTH
 Ai 17-5123-12
 12.5cm



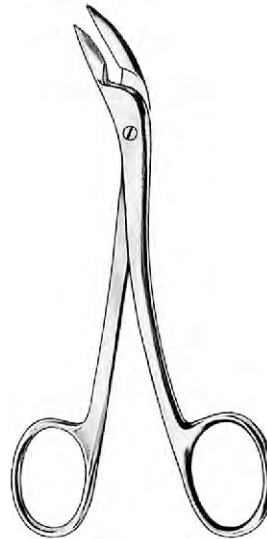
CHILDE
 Ai 17-5124-18
 18.0cm



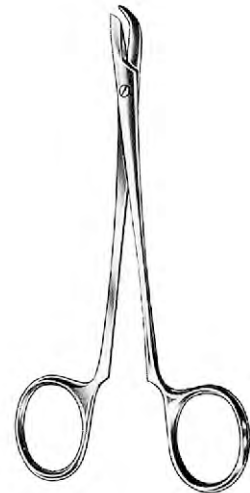
CHILDE
 Ai 17-5125-18
 18.0cm



MICHEL
 Ai 17-5126-12
 12.5cm



RICHTER- HEATH
 Ai 17-5127-14
 14.0cm



COLLIN
 Ai 17-5128-13
 13.0cm





TC GOLD



Castroviejo

14cm/5½"
 18cm/7"
 21cm/8¼"



Ai 17-5131-14
 Ai 17-5131-18
 Ai 17-5131-21

Smooth



Ai 17-5132-14
 Ai 17-5132-18
 Ai 17-5132-21



14cm/5½"
 18cm/7"
 21cm/8¼"

Ai 17-5133-14
 Ai 17-5133-18
 Ai 17-5133-21



Ai 17-5134-14
 Ai 17-5134-18
 Ai 17-5134-21



Kalt
 14cm/5½"



Ai 17-5135-14



Ai 17-5136-14



Barraquer
 Ai 17-5137-14
 14cm/5 ½"



Castroviejo
 Ai 17-5138-13
 13cm/5"



Hepp-Schiedel
 18cm/7"



Ai 17-5139-18

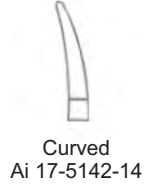


Ai 17-5140-18
 Smooth

TC GOLD



Arruga
14cm/5½"



Jacobson
 Ai 17-5143-18 18cm/7"
 Ai 17-5143-20 20cm/8"
 Ai 17-5143-23 23cm/8¾"

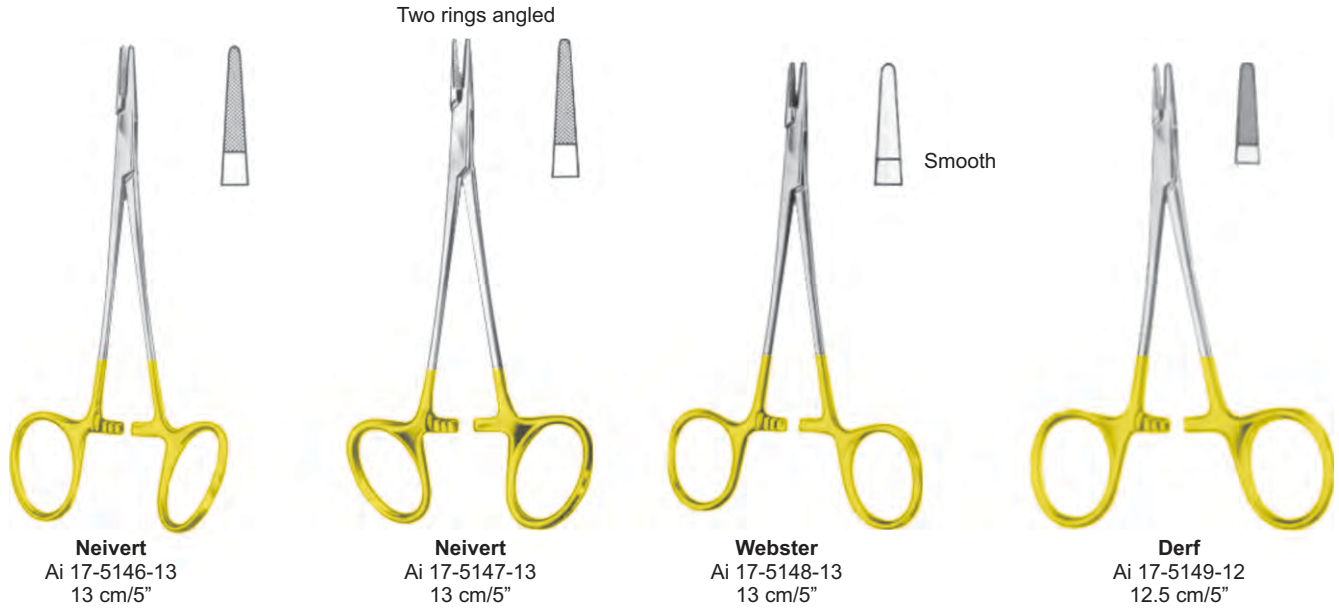


Diethrich

Straight		Curved
Ai 17-5144-16	16cm/6¼"	Ai 17-5145-16
Ai 17-5144-18	18cm/7"	Ai 17-5145-18
Ai 17-5144-20	20cm/8"	Ai 17-5145-20
Ai 17-5144-23	23cm/9"	Ai 17-5145-23
Ai 17-5144-25	25cm/10"	Ai 17-5145-25



TC GOLD



TC GOLD



Mayo-Hegar

- Ai 17-5152-16
- Ai 17-5152-18
- Ai 17-5152-20
- Ai 17-5152-24
- Ai 17-5152-26
- Ai 17-5152-30



- Ai 17-5153-20
- Ai 17-5153-24
- Ai 17-5153-26

- 16cm/6¼"
- 18cm/7"
- 20cm/8"
- 24cm/9½"
- 26cm/10½"
- 30cm/12"



Hegar-Baumgartner
 Ai 17-5154-14
 14cm/5½"



Heavy Pattern

- Mayo-Hegar**
 Ai 17-5155-20 20cm/8"
 Ai 17-5155-24 24cm/9 ½"



- De Bakey**
 Ai 17-5156-18 18cm/7"
 Ai 17-5156-20 20cm/8"
 Ai 17-5156-23 23cm/9"
 Ai 17-5156-26 26cm/10¼"
 Ai 17-5156-31 31cm/12¼"



- De Bakey-Fine**
 Ai 17-5157-18 18cm/7"
 Ai 17-5157-20 20cm/8"
 Ai 17-5157-23 23cm/9"
 Ai 17-5157-26 26cm/10¼"
 Ai 17-5157-31 31cm/12¼"

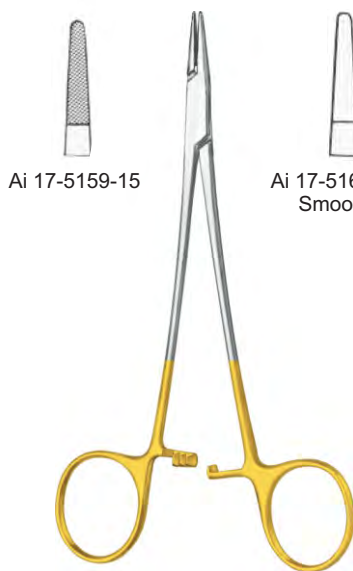




TC GOLD



Baby-Crile-Wood
 Ai 17-5158-15
 15cm/6"



Ai 17-5159-15

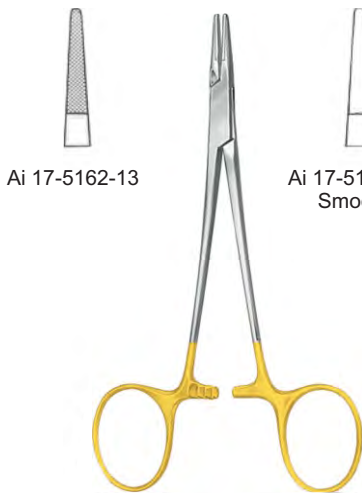
Ai 17-5160-15
 Smooth

Crile-Wood
 15cm/6"



Crile-Wood

	cm	in
Ai 17-5161-18	18	7"
Ai 17-5161-20	20	8"
Ai 17-5161-23	23	9"
Ai 17-5161-26	26	10 1/4"
Ai 17-5161-31	31	12 1/4"



Ai 17-5162-13

Ai 17-5163-13
 Smooth

Halsey
 13cm/5"



Converse
 Ai 17-5164-12
 12.5cm/5"



Kilner
 Ai 17-5165-13
 13.5cm/5 1/4"

TC GOLD



Hegar-Vascular
 Ai 17-5166-14 14cm/5½"
 Ai 17-5166-18 18cm/7"
 Ai 17-5166-20 20cm/8"
 Ai 17-5166-23 23cm/9"



Ryder
 Ai 17-5167-13
 Ai 17-5167-15
 Ai 17-5167-18
 Ai 17-5167-20
 Ai 17-5167-23
 Ai 17-5167-26



Micro-Ryder
 Ai 17-5168-13 13cm/5"
 Ai 17-5168-15 15cm/6"
 Ai 17-5168-18 18cm/7"
 Ai 17-5168-20 20cm/8"
 Ai 17-5168-23 23cm/9"
 Ai 17-5168-26 26cm/10¼"



(Swedish Pattern)
 Ai 17-5169-15 15cm/6"
 Ai 17-5169-17 17cm/6¾"
 Ai 17-5169-20 20cm/8"



Sarot
 Ai 17-5170-18 18cm/7"
 Ai 17-5170-26 26cm/10¼"





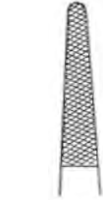
TC GOLD



Stratte
 Ai 17-5171-23
 23cm/9"



Masson
 17-5172-27
 27cm/10½"



Wangenstein
 Ai 17-5173-27
 27cm/10½"



Finocchetto
 Ai 17-5174-20 20cm/8"
 Ai 17-5174-27 27cm/10½"

TC GOLD



Mathieu

14cm/5½" Ai 17-5175-14
 17cm/6¾" Ai 17-5175-17
 20cm8" Ai 17-5175-20
 24cm/9½" Ai 17-5175-24



Mathieu

Ai 17-5176-14
 Ai 17-5176-17
 Ai 17-5176-20
 Ai 17-5176-24



Mathieu-Ryder

Ai 17-5177-17
 Ai 17-5177-20



Langenbeck

16cm/6¼" Ai 17-5178-16
 18cm/7" Ai 17-5178-18
 20cm/8" Ai 17-5178-20



Langenbeck-Ryder

Ai 17-5179-18
 Ai 17-5179-20



Lichtenberg

Ai 17-5180-20



TC GOLD



Toennis
 Ai 17-5181-18
 18 cm/7"



Mathieu-Kocher
 Ai 17-5182-14 14 cm/5 1/2"
 Ai 17-5182-17 17 cm/6 3/4"
 Ai 17-5182-20 20 cm/8"



Axhausen
 Ai 17-5183-18
 18.5 cm/7 1/4"



Zweifel
 Ai 17-5184-20 20 cm/8"
 Ai 17-5184-23 23 cm/9"



TC GOLD



Ai 17-5185-20 20 cm/8"
Ai 17-5185-25 25 cm/10"



Mathieu
Ai 17-5186-20 20 cm/8"
Ai 17-5186-24 24 cm/9½"



Metzenbaum
Ai 17-5187-17 17 cm/6¾"
Ai 17-5187-20 20 cm/8"



Ai 17-5188-16



Ai 17-5189-16

Arruga
16 cm/6¼"



Boynton
Ai 17-5190-12 12 cm/4¾"



Hosel
Ai 17-5191-20 20 cm/8"
Ai 17-5191-25 25 cm/10"



TC GOLD



Baby-Olsen-Hegar
 Ai 17-5192-11
 11.5 cm/4½"



Olsen-Hegar
 Ai 17-5193-14
 14 cm/5½"



Olsen-Hegar
 Ai 17-5194-17
 17 cm/6¾"



Olsen-Hegar
 Ai 17-5195-18
 18 cm/7"



Gillies-Slim
 Ai 17-5196-14
 14.5 cm/5½"



Gillies
 Ai 17-5197-16 (right hand)
 Ai 17-5198-16 (left hand)
 16 cm/6¼"

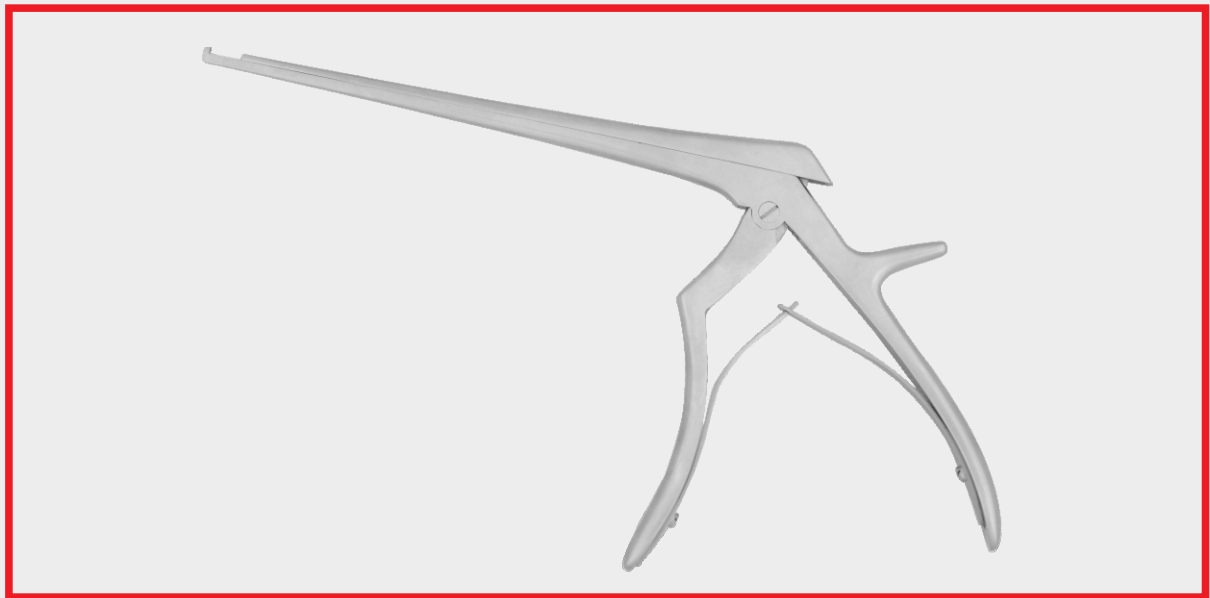


EN Neurosurgery

DE Neurochirurgie

ES Neuro Cirugía

Page 378 to 387





FRAZIER
 Ai 18-5301-15
 15 cm/5 3/8"



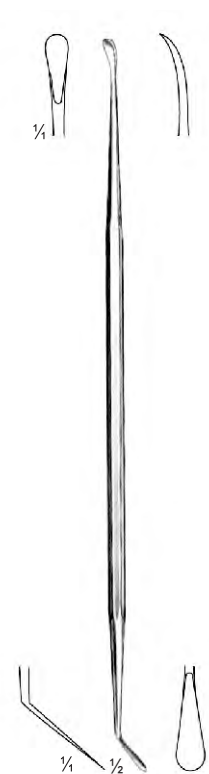
HOEN
 Ai 18-5302-15
 15 cm/5 3/8"



HOEN
 Ai 18-5303-15
 15 cm/5 3/8"



SACHS
 Ai 18-5304-21
 21 cm/8 1/4"



MILLIGAN
 Ai 18-5305-21
 21 cm/8 1/4"



SACHS
 Ai 18-5306-21
 21 cm/8 1/4"



Ai 18-5307-22
 22 cm/8 3/4"



WOODSON
 Ai 18-5308-25
 25 cm/9 7/8"



DAVIS
 Ai 18-5309-24
 24.5 cm/9 5/8"



Ai 18-5310-21
 21 cm/8 1/4"



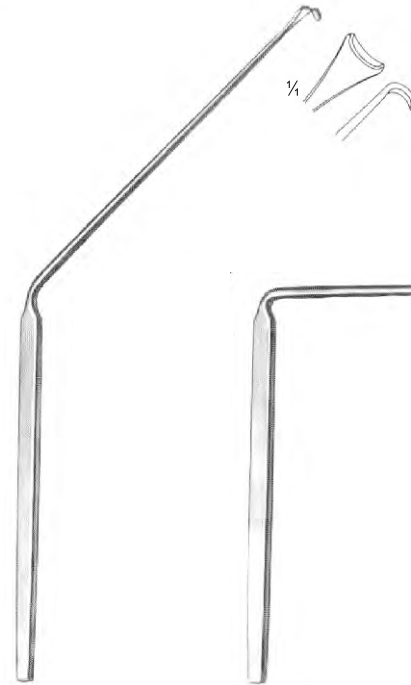
FAGER
 Ai 18-5311-20
 20 cm/7 7/8"



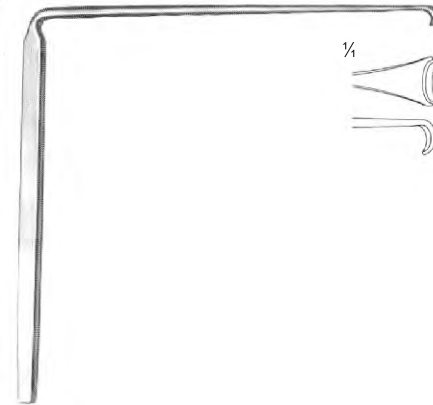
FAGER
 Ai 18-5312-20
 20 cm/7 7/8"



1/2
LOVE
Ai 18-5313-21
21.5 cm/8 1/2"



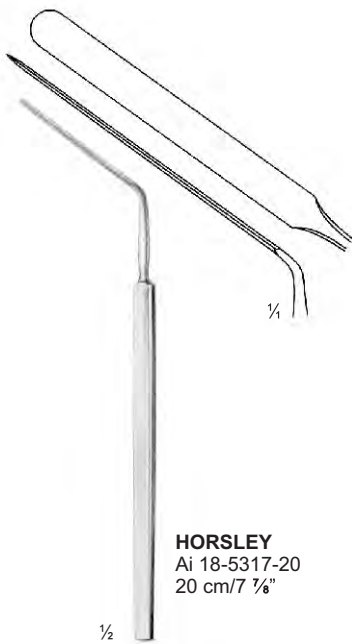
LOVE
Ai 18-5314-17
17.5 cm/6 7/8"



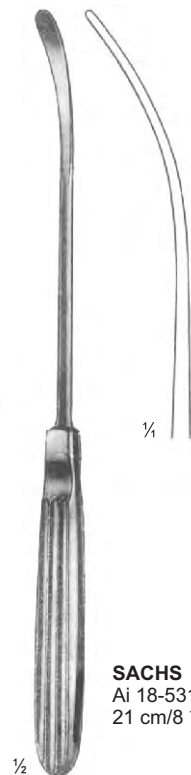
LOVE
Ai 18-5315-11
11 cm/4 3/8"



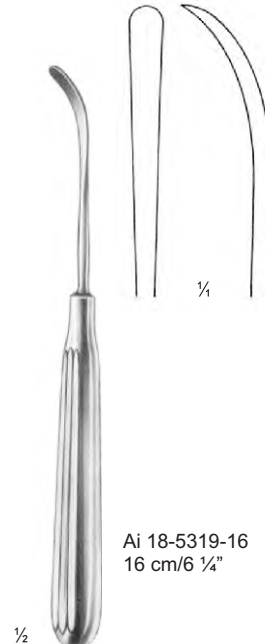
1/2
WOODSON
Ai 18-5316-17
17 cm/6 3/4"



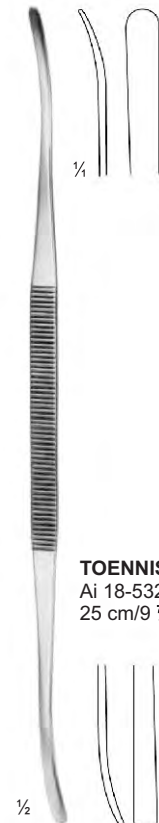
1/2
HORSLEY
Ai 18-5317-20
20 cm/7 7/8"



SACHS
Ai 18-5318-21
21 cm/8 1/4"

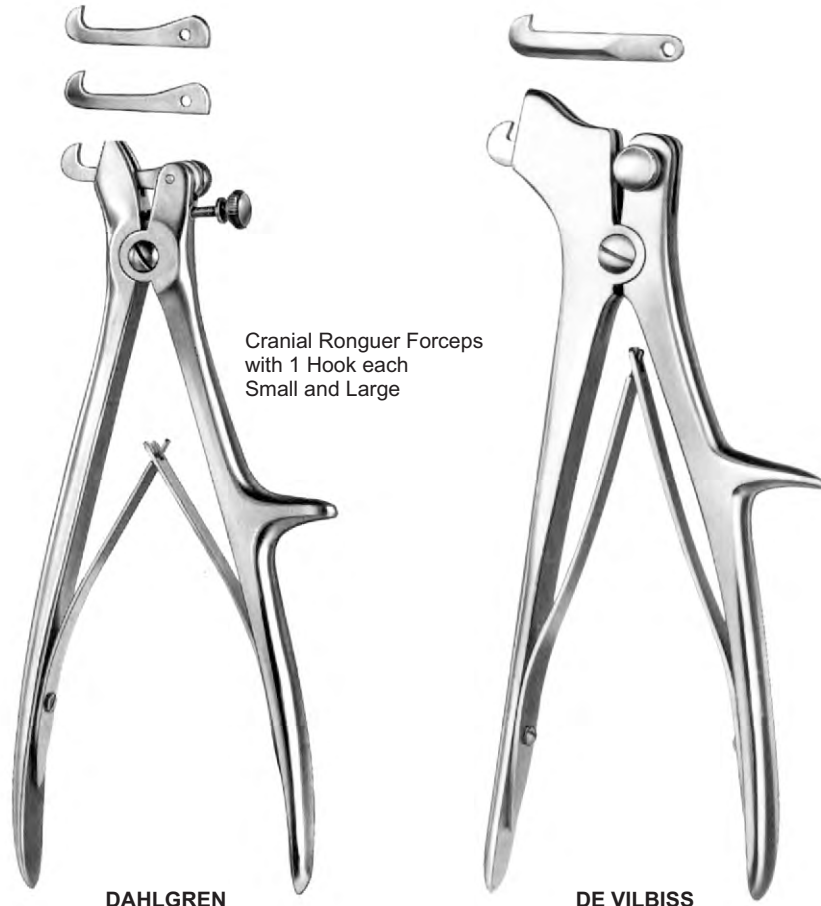


Ai 18-5319-16
16 cm/6 1/4"



TOENNIS
Ai 18-5320-20
25 cm/9 7/8"





Cranial Rongeur Forceps
with 1 Hook each
Small and Large

DAHLGREN
Ai 18-5321-20
20 cm/7 7/8"

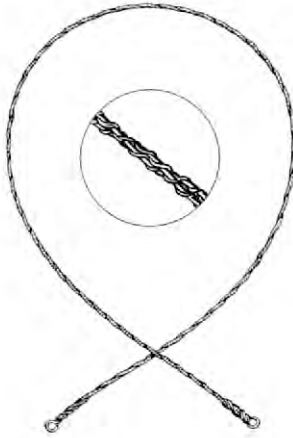
DE VILBISS
Ai 18-5322-21
21 cm/8 1/4"



McKENZIE
Ai 18-5323-15 15cm/5 7/8"
Ai 18-5323-19 19cm/7 1/2"

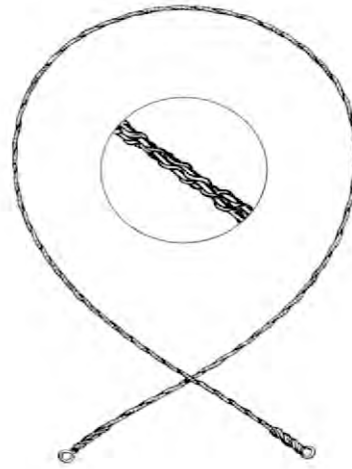
McKENZIE
Ai 18-5324-15 15cm/5 7/8"
Ai 18-5324-19 19cm/7 1/2"

RANEY
Ai 18-5325
Applying and removing
forceps for scalp hemostasis clip



GIGLI-WIRE SAW
2 wires twisted

- Ai 18-5326-30 30cm
- Ai 18-5326-40 40cm
- Ai 18-5326-50 50cm
- Ai 18-5326-60 60cm
- Ai 18-5326-70 70cm



GIGLI-WIRE SAW
6 wires twisted

- Ai 18-5327-30 30cm
- Ai 18-5327-40 40cm
- Ai 18-5327-50 50cm

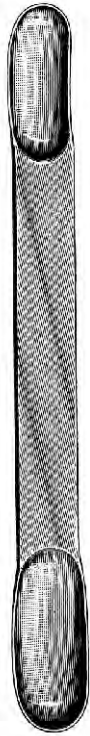


GIGLI
Ai 18-5328-07
7 cm/2 3/4"
Hook handle
for wire saw

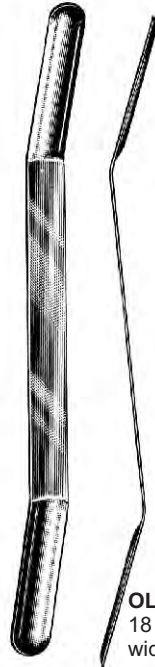


De MARTEL
Ai 18-5329-33
33 cm/13"
Conductor for
wire saws



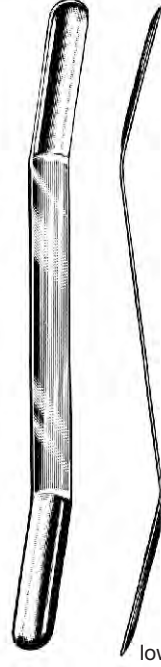


CUSHING
 Ai 18-5330-17 17cm/6 3/4"
 Ai 18-5330-20 20cm/7 7/8"
 Ai 18-5330-28 28cm/11"



OLIVECRONA
 18 cm/7 1/8"
 width of spatulas

Concave	upper end
Ai 18-5331-18	7 + 9 mm
Ai 18-5332-18	11 + 13 mm
Ai 18-5333-18	15 + 18 mm
Ai 18-5334-18	18 + 22 mm



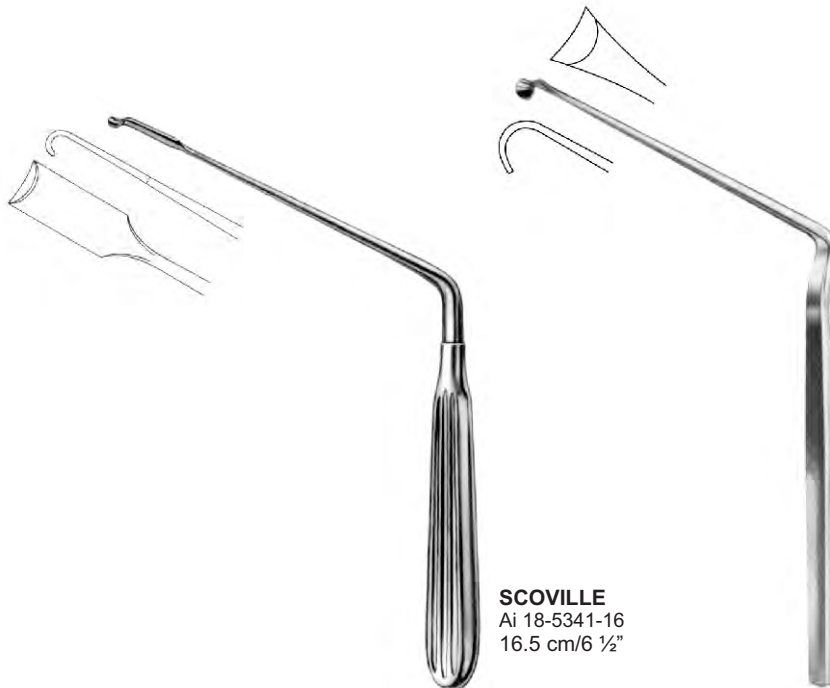
Convex
 Ai 18-5335-18
 Ai 18-5336-18
 Ai 18-5337-18
 Ai 18-5338-18



SCOVILLE
 Ai 18-5339-23
 23 cm/9"

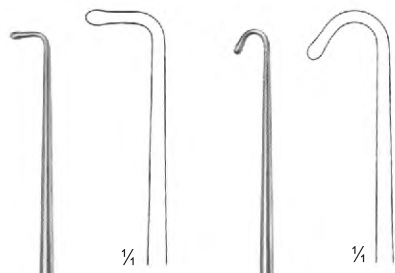


HOLSHER
 Ai 18-5340-24
 24 cm/9 1/2"



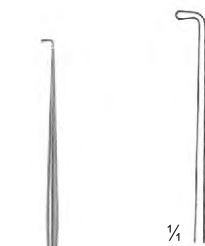
SCOVILLE
 Ai 18-5341-16
 16.5 cm/6 1/2"

Ai 18-5342-21
 21 cm/8 1/4"



GRONINGEN
 Ai 18-5343-26
 26.5 cm/10 3/8"

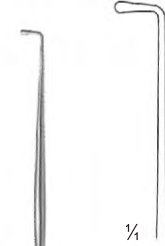
GRONINGEN
 Ai 18-5344-26
 26.5 cm/10 3/8"



CUSHING

Fig. 1
 Ai 18-5345-19
 19 cm/7 1/2"

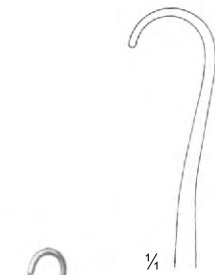
Fig. 1
 Ai 18-5345-28
 28 cm/11"



CUSHING

Fig. 2
 Ai 18-5346-19
 19 cm/7 1/2"

Fig. 2
 Ai 18-5346-28
 28 cm/11"

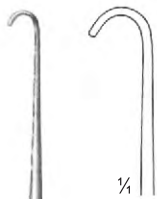


SMITHWICK

DF-237-2787
 17 cm/6 3/4"

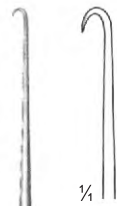
Ai 18-5347-21
 21 cm/8 1/4"





1/2

GRAHAM
 Ai 18-5348-16
 16.5 cm/6 1/2"



1/2

SACHS
 Ai 18-5349-17
 17 cm/6 3/4"



1/2

FRAZIER



Ai 18-5350-13
 13 cm/5 1/8"
 sharp



Ai 18-5350-18
 18 cm/7 1/8"
 sharp



1/2

ADSON
 Ai 18-5351-20
 20 cm/7 7/8"

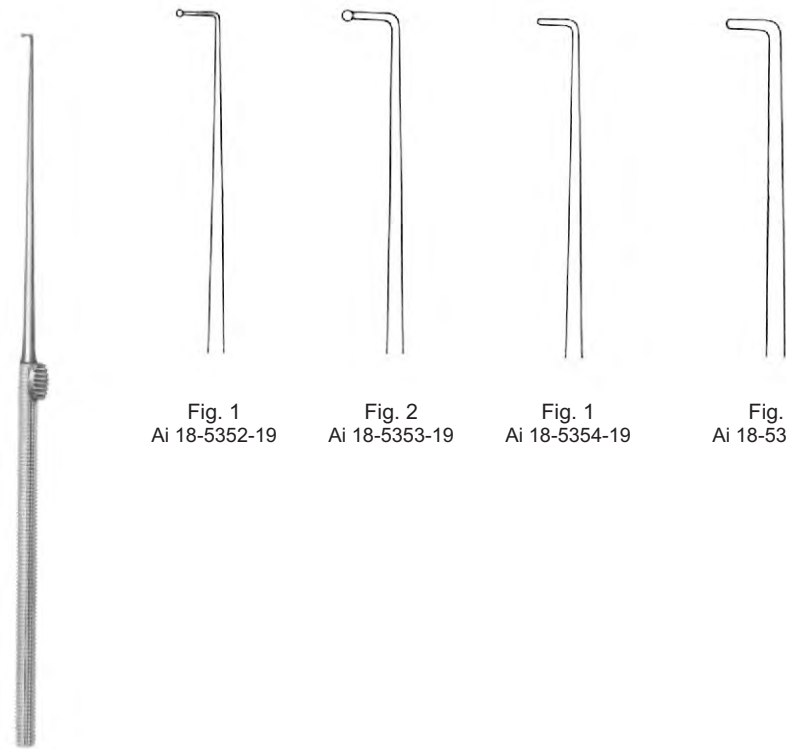


Fig. 1
Ai 18-5352-19

Fig. 2
Ai 18-5353-19

Fig. 1
Ai 18-5354-19

Fig. 2
Ai 18-5355-19

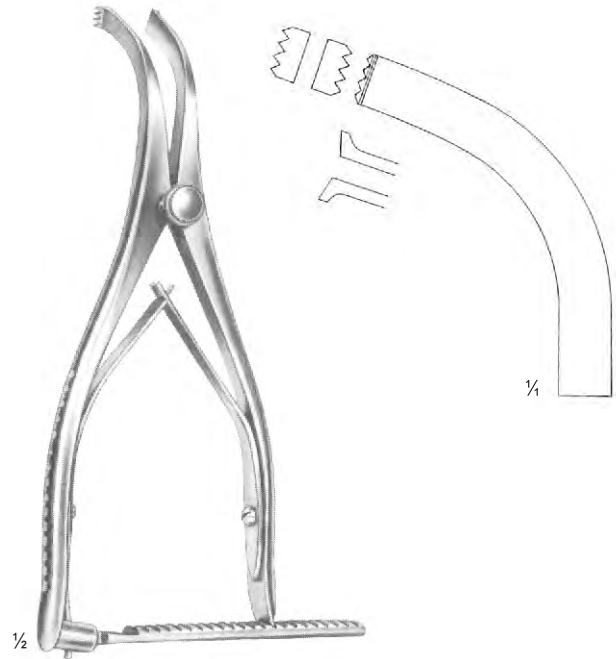
KRAYENBÜHL
19 cm/7 1/2"





blade opening
18 mm

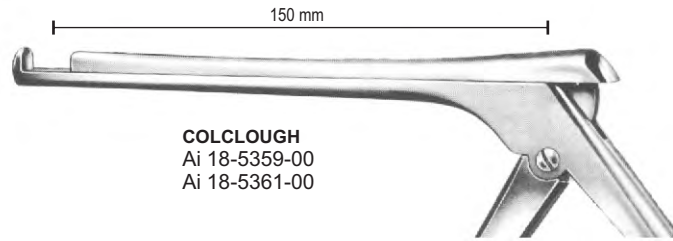
CLOWARD
 Ai 18-5356-16
 16 cm/6 1/4"



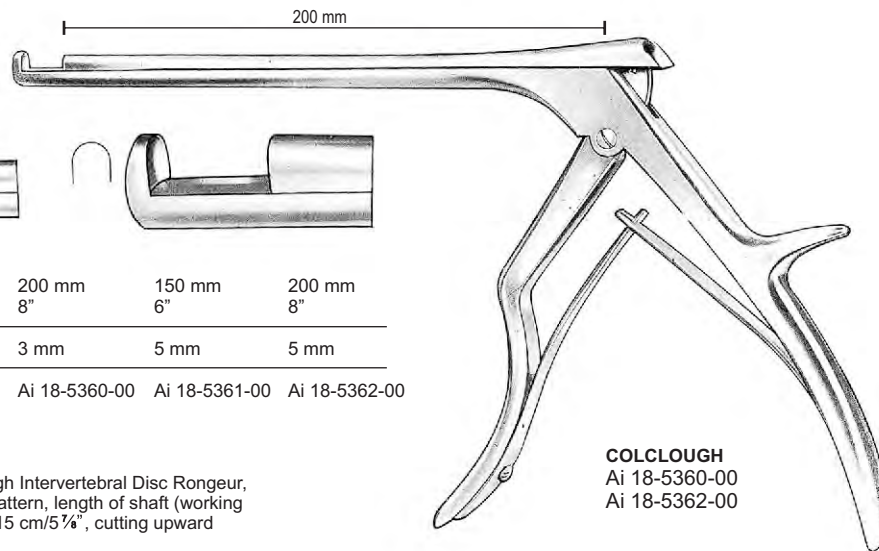
INGE
 Ai 18-5357-16
 16.5 cm/6 1/2"
 Blade opening 35 mm



INGE
 Ai 18-5358-25
 25.5 cm/10"
 Blade opening 70 mm



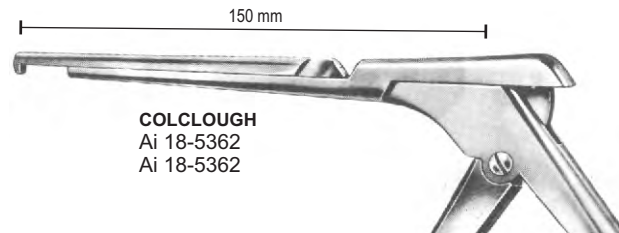
COLCLOUGH
 Ai 18-5359-00
 Ai 18-5361-00



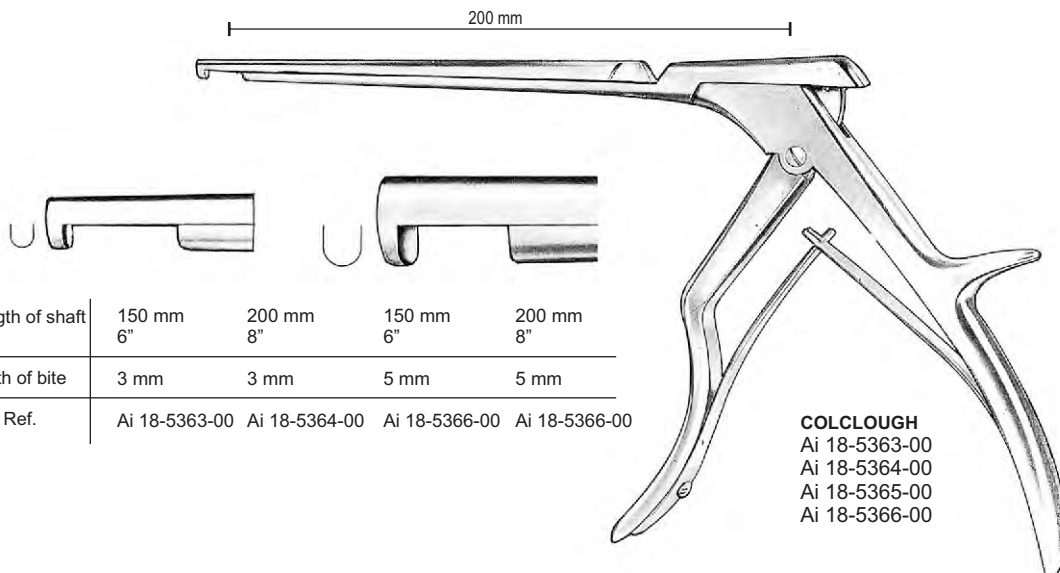
COLCLOUGH
 Ai 18-5360-00
 Ai 18-5362-00

Length of shaft	150 mm 6"	200 mm 8"	150 mm 6"	200 mm 8"
Width of bite	3 mm	3 mm	5 mm	5 mm
Cat. Ref.	Ai 18-5359-00	Ai 18-5360-00	Ai 18-5361-00	Ai 18-5362-00

- Ai 18-5359-00 - Ai 18-5361-00 Colclough Intervertebral Disc Rongeur, heavy pattern, length of shaft (working length) 15 cm/5 7/8", cutting upward desired.
- Ai 18-5360-00 - Ai 18-5362-00 ditto, length of shaft (working length) 20 cm/7 7/8"
- Ai 18-5362-00 - Ai 18-5363-00 ditto, length of shaft (working length) 15 cm/5 7/8", cutting downward
- Ai 18-5362-00 - Ai 18-5362-00 ditto, length of shaft (working length) 20 cm/7 7/8"



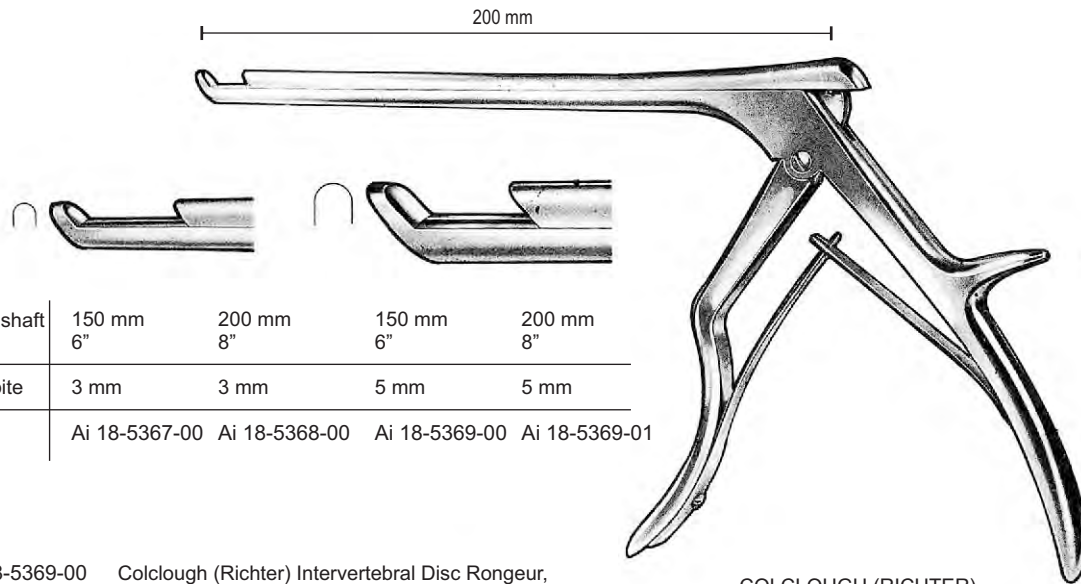
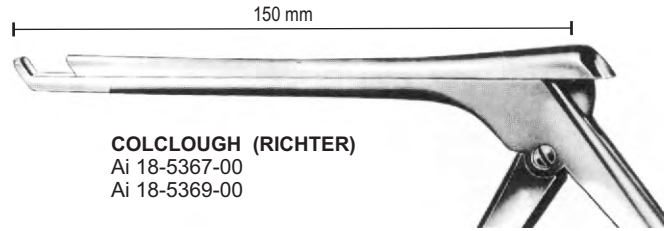
COLCLOUGH
 Ai 18-5362
 Ai 18-5362



Length of shaft	150 mm 6"	200 mm 8"	150 mm 6"	200 mm 8"
Width of bite	3 mm	3 mm	5 mm	5 mm
Cat. Ref.	Ai 18-5363-00	Ai 18-5364-00	Ai 18-5366-00	Ai 18-5366-00

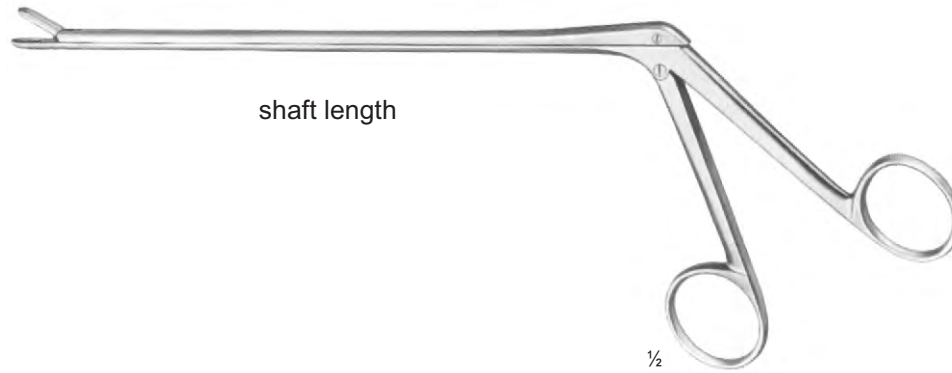
COLCLOUGH
 Ai 18-5363-00
 Ai 18-5364-00
 Ai 18-5365-00
 Ai 18-5366-00





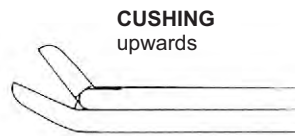
Ai 18-5367-00 - Ai 18-5369-00 Colclough (Richter) Intervertebral Disc Rongeur, heavy pattern, length of shaft (working length) 15 cm/6", cutting 40° forward

Ai 18-5368-00 - Ai 18-5369-01 ditto, length of shaft (working length) 20 cm/7 7/8"



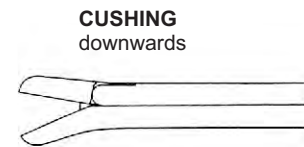
CUSHING
 straight

Ai 18-5370-12 120 mm
 Ai 18-5370-15 150 mm
 Ai 18-5370-18 180 mm



CUSHING
 upwards

Ai 18-5371-12 120 mm
 Ai 18-5371-15 150 mm
 Ai 18-5371-18 180 mm



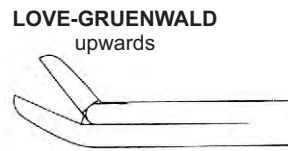
CUSHING
 downwards

Ai 18-5372-12 120 mm
 Ai 18-5372-15 150 mm
 Ai 18-5372-18 180 mm



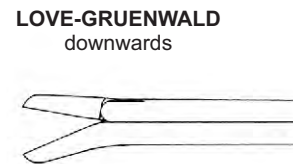
LOVE-GRUENWALD
 straight

Ai 18-5373-12 120 mm
 Ai 18-5373-15 150 mm
 Ai 18-5373-18 180 mm



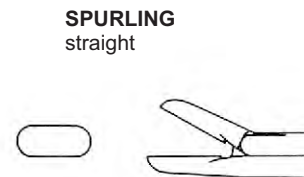
LOVE-GRUENWALD
 upwards

Ai 18-5374-12 120 mm
 Ai 18-5374-15 150 mm
 Ai 18-5374-18 180 mm



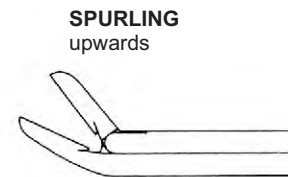
LOVE-GRUENWALD
 downwards

Ai 18-5375-12 120 mm
 Ai 18-5375-15 150 mm
 Ai 18-5375-18 180 mm



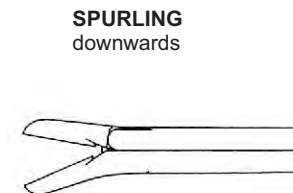
SPURLING
 straight

Ai 18-5376-12 120 mm
 Ai 18-5376-15 150 mm
 Ai 18-5376-18 180 mm



SPURLING
 upwards

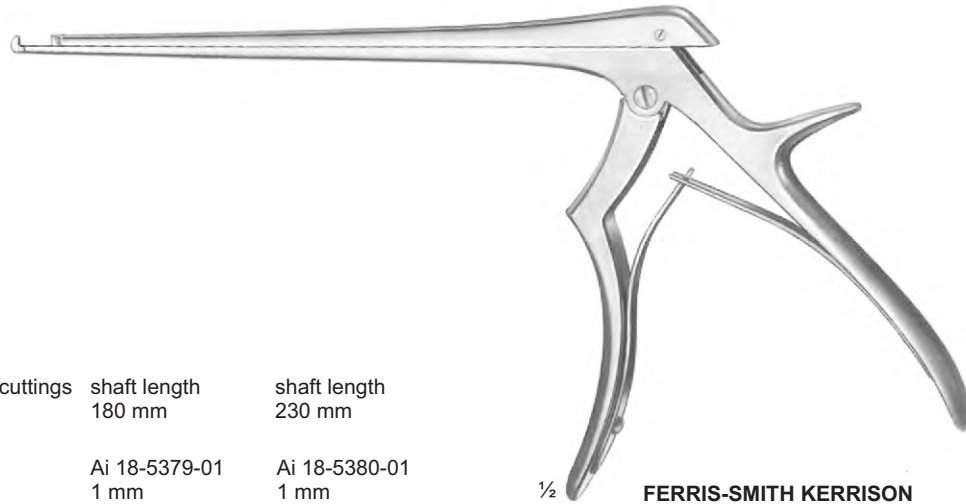
Ai 18-5377-12 120 mm
 Ai 18-5377-15 150 mm
 Ai 18-5377-18 180 mm



SPURLING
 downwards

Ai 18-5378-12 120 mm
 Ai 18-5378-15 150 mm
 Ai 18-5378-18 180 mm





½ **FERRIS-SMITH KERRISON**

upwards cuttings	shaft length 180 mm	shaft length 230 mm
	Ai 18-5379-01 1 mm	Ai 18-5380-01 1 mm
	Ai 18-5379-02 2 mm	Ai 18-5380-02 2 mm
	Ai 18-5379-03 3 mm	Ai 18-5380-03 3 mm
	Ai 18-5379-04 4 mm	Ai 18-5380-04 4 mm
	Ai 18-5379-05 5 mm	Ai 18-5380-05 5 mm
	Ai 18-5379-06 6 mm	Ai 18-5380-06 6 mm

downwards cuttings	shaft length 180 mm
	Ai 18-5383-03 3 mm

downwards cuttings	shaft length 180 mm	shaft length 230 mm
	Ai 18-5381-01 1 mm	Ai 18-5382-01 1 mm
	Ai 18-5381-02 2 mm	Ai 18-5382-02 2 mm
	Ai 18-5383-03 3 mm	Ai 18-5382-03 3 mm
	Ai 18-5383-04 4 mm	Ai 18-5382-04 4 mm
	Ai 18-5383-05 5 mm	Ai 18-5382-05 5 mm
	Ai 18-5383-06 6 mm	Ai 18-5382-06 6 mm

upwards cuttings	shaft length 180 mm	shaft length 230 mm
	Ai 18-5384-01 1 mm	Ai 18-5385-01 1 mm
	Ai 18-5384-02 2 mm	Ai 18-5385-02 2 mm
	Ai 18-5384-03 3 mm	Ai 18-5385-03 3 mm
	Ai 18-5384-04 4 mm	Ai 18-5385-04 4 mm
	Ai 18-5384-05 5 mm	Ai 18-5385-05 5 mm
	Ai 18-5384-06 6 mm	Ai 18-5385-06 6 mm



FERRIS-SMITH KERRISON

upwards cuttings	shaft length 180 mm	shaft length 230 mm	upwards cuttings	shaft length 180 mm	shaft length 230 mm
	Ai 18-5386-1 1 mm	Ai 18-5387-1 1 mm		Ai 18-5388-1 1 mm	Ai 18-5389-1 1 mm
	Ai 18-5386-2 2 mm	Ai 18-5387-2 2 mm		Ai 18-5388-2 2 mm	Ai 18-5389-2 2 mm
	Ai 18-5386-3 3 mm	Ai 18-5387-3 3 mm		Ai 18-5388-3 3 mm	Ai 18-5389-3 3 mm
	Ai 18-5386-4 4 mm	Ai 18-5387-4 4 mm		Ai 18-5388-4 4 mm	Ai 18-5389-4 4 mm
	Ai 18-5386-5 5 mm	Ai 18-5387-5 5 mm		Ai 18-5388-5 5 mm	Ai 18-5389-5 5 mm
	Ai 18-5386-6 6 mm	Ai 18-5387-6 6 mm		Ai 18-5388-6 6 mm	Ai 18-5389-6 6 mm



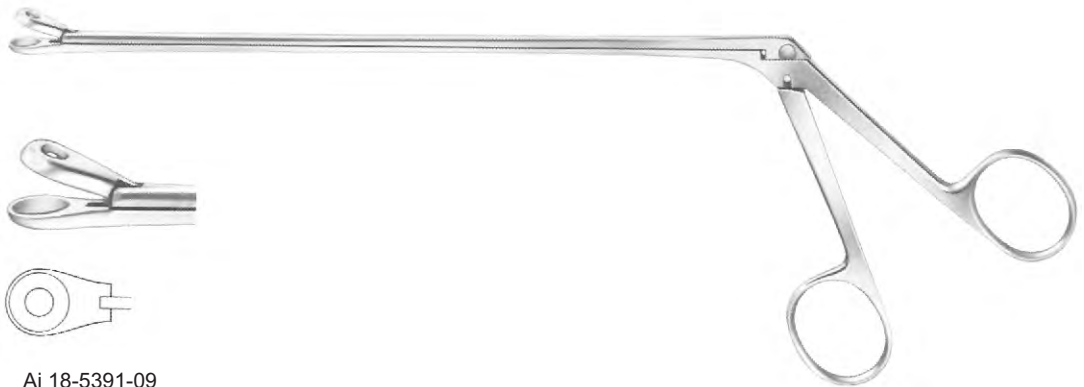


Ai 18-5390-02
 Ø 2.2 mm

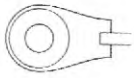


Ai 18-5390-03
 Ø 3.5 mm

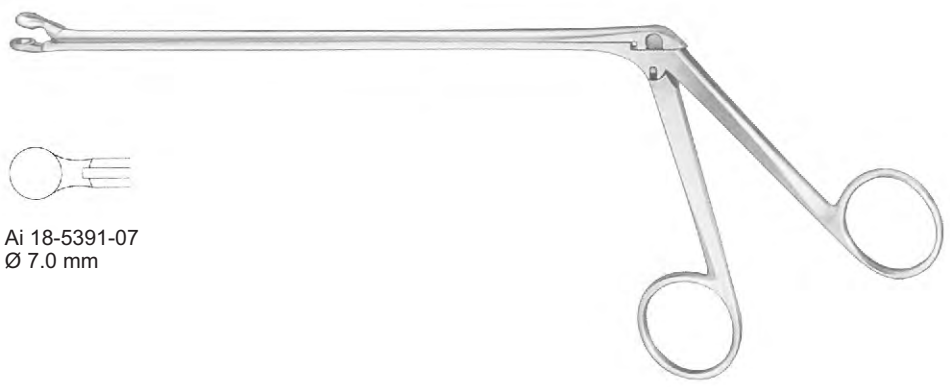
YASARGIL



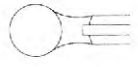
Ai 18-5391-09
 Ø 9.0 mm



LANDOLT
 Tumor grasping forceps, blunt



Ai 18-5391-07
 Ø 7.0 mm



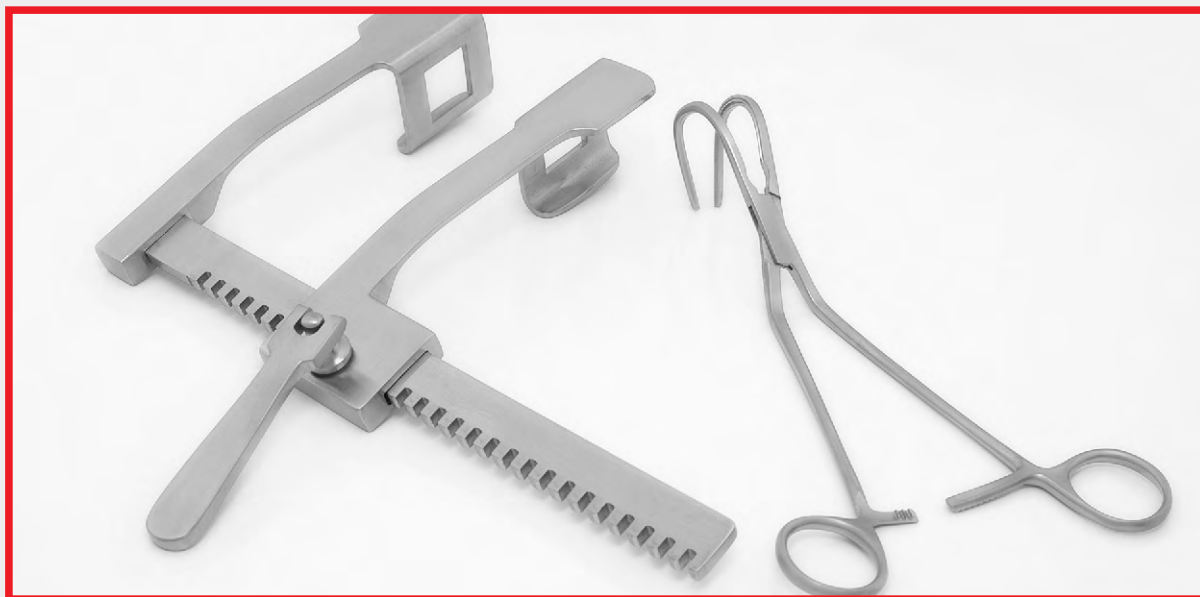
OLDBERG

EN Cardiovascular Surgery

DE Herz- und Gefäßchirurgie

ES Cirugía cardiovascular

Page 388 to 498





1.5 mm

Ai 19-5501-12 12.5cm
Ai 19-5501-15 15cm

DEBAKEY-ADSON



1.0 mm

Ai 19-5502-15 15.0cm
Ai 19-5502-18 18.0cm



1.2 mm

Ai 19-5503-15 15.0cm
Ai 19-5503-18 18.0cm
Ai 19-5503-24 24.0cm

DEBAKEY-GERALD



1.0mm

Ai 19-5504-18 18.0cm

DEBAKEY-CUSHING



1.0mm

Ai 19-5505-15 15.0cm
Ai 19-5505-19 19.0cm
Ai 19-5505-24 24.0cm

DEBAKEY-DIETRICH



1.5mm

Ai 19-5506-15 15.0cm
Ai 19-5506-19 19.0cm
Ai 19-5506-24 24.0cm



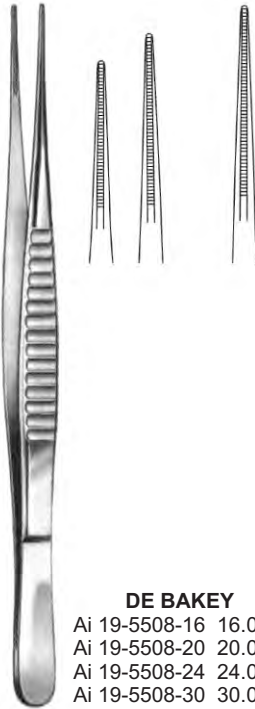
1.0mm

Ai 19-5507-15 15.0cm
Ai 19-5507-19 19.0cm
Ai 19-5507-24 24.0cm

DEBAKEY-LIGHT

Also available in titanium

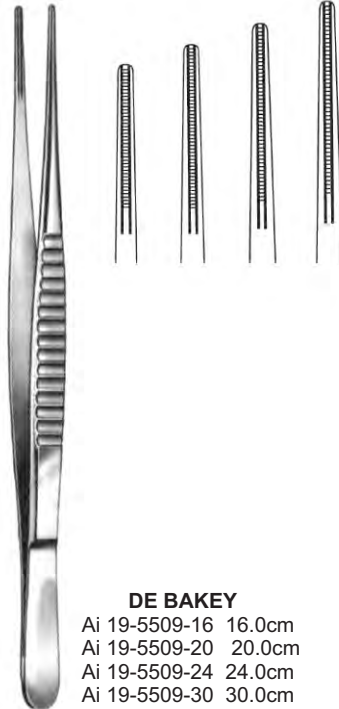
1.5 mm



DE BAKEY

- Ai 19-5508-16 16.0cm
- Ai 19-5508-20 20.0cm
- Ai 19-5508-24 24.0cm
- Ai 19-5508-30 30.0cm

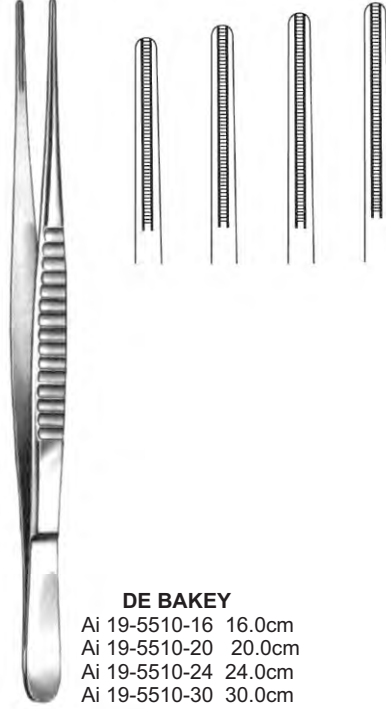
2.0 mm



DE BAKEY

- Ai 19-5509-16 16.0cm
- Ai 19-5509-20 20.0cm
- Ai 19-5509-24 24.0cm
- Ai 19-5509-30 30.0cm

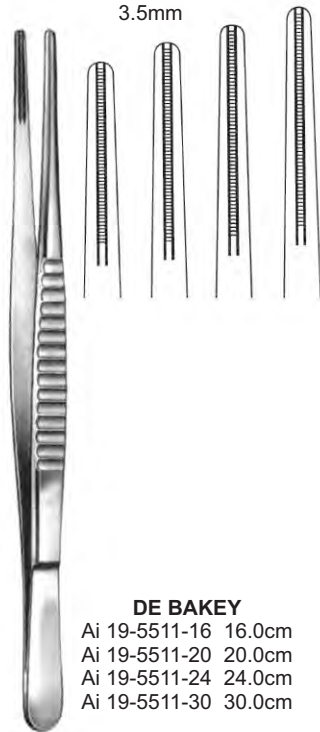
2.7 mm



DE BAKEY

- Ai 19-5510-16 16.0cm
- Ai 19-5510-20 20.0cm
- Ai 19-5510-24 24.0cm
- Ai 19-5510-30 30.0cm

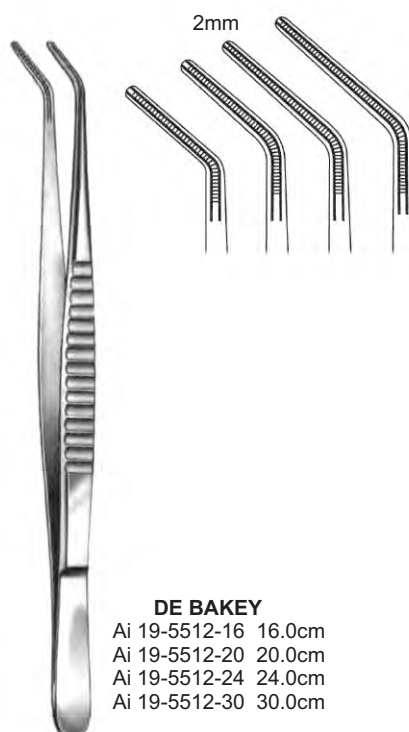
3.5mm



DE BAKEY

- Ai 19-5511-16 16.0cm
- Ai 19-5511-20 20.0cm
- Ai 19-5511-24 24.0cm
- Ai 19-5511-30 30.0cm

2mm



DE BAKEY

- Ai 19-5512-16 16.0cm
- Ai 19-5512-20 20.0cm
- Ai 19-5512-24 24.0cm
- Ai 19-5512-30 30.0cm

2.7mm



DE BAKEY

- Ai 19-5513-16 16.0cm
- Ai 19-5513-20 20.0cm
- Ai 19-5513-24 24.0cm
- Ai 19-5513-30 30.0cm

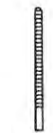


Also available in titanium



MINI-GLOVER

Ai 19-5514-03 3.5cm
Ai 19-5514-04 4.5cm



Ai 19-5515-03
Ai 19-5515-04



GLOVER
Ai 19-5518-05
5.0cm



GLOVER (DELICATE)

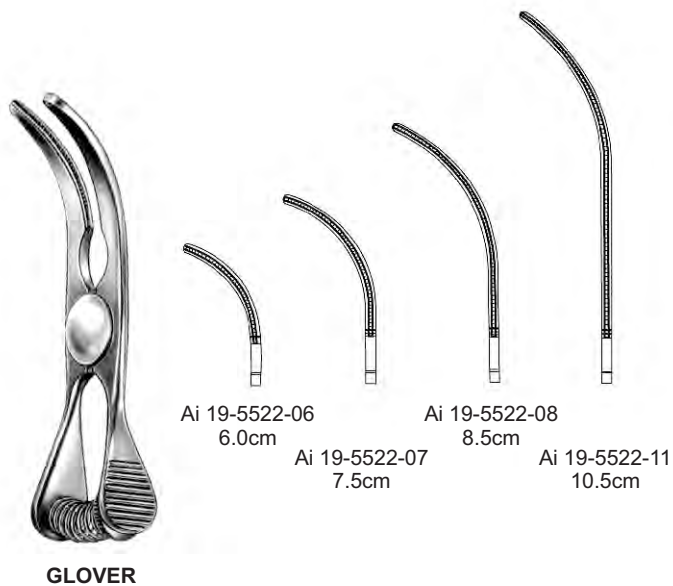
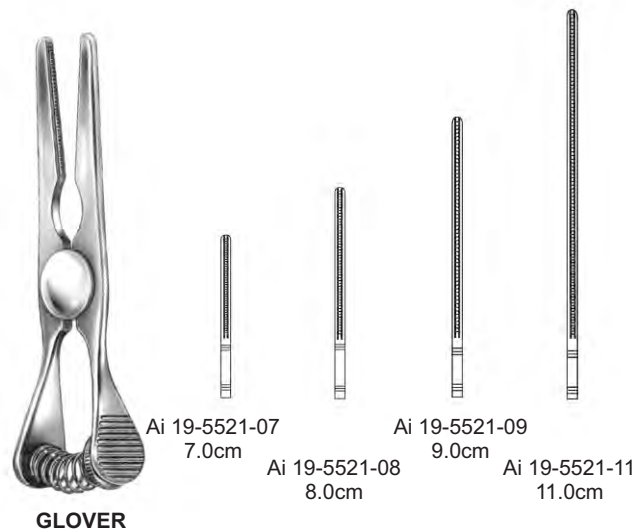
Ai 19-5519-05 5.0cm
Ai 19-5519-06 6.8cm
Ai 19-5519-08 8.5cm



Ai 19-5520-05 4.6cm
Ai 19-5520-06 6.4cm
Ai 19-5520-08 7.8cm



Also available in titanium



Also available in titanium



DE BAKEY



Ai 19-5529-07
7.5cm



Ai 19-5529-08
8.5cm



Ai 19-5529-10
10.5cm



Ai 19-5529-12
12.0cm

Also available in titanium

DE BAKEY



DE BAKEY



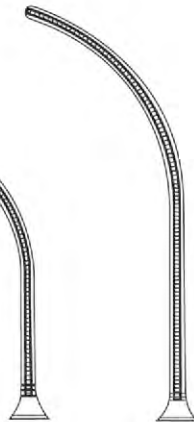
Ai 19-5530-07
7.0cm



Ai 19-5530-08
8.0cm



Ai 19-5530-10
10.0cm



Ai 19-5530-11
11.5cm



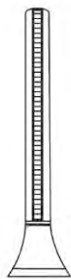
Ai 19-5531-23
23.0cm



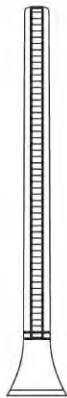
Also available in titanium



GREGORY SOFT



Ai 19-5532-09
9.0cm



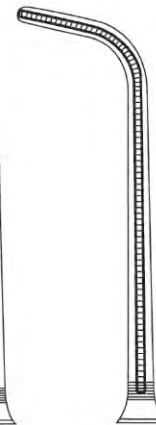
Ai 19-5532-11
11.0cm



GREGORY SOFT



Ai 19-5533-09
9.0cm



Ai 19-5533-11
11.0cm



GREGORY SOFT
11.0cm



Ai 19-5534-01



Ai 19-5534-02



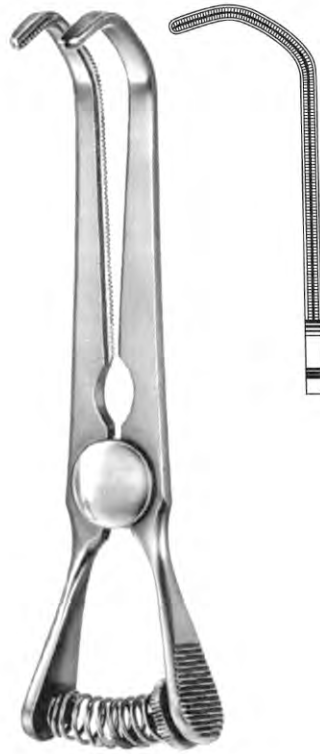
SANTULLI
Ai 19-5535-07
7.0cm



Also available in titanium



DE BAKEY-SATINSKY
Ai 19-5536-07
7.0cm

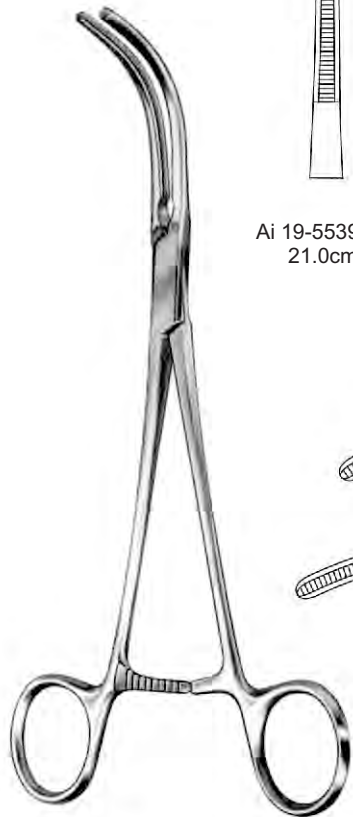


DE BAKEY-SATINSKY
Ai 19-5537-10
10.0cm

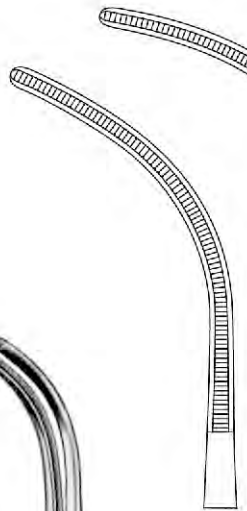


DE BAKEY-CAROTIS
Ai 19-5538-09
9.0cm

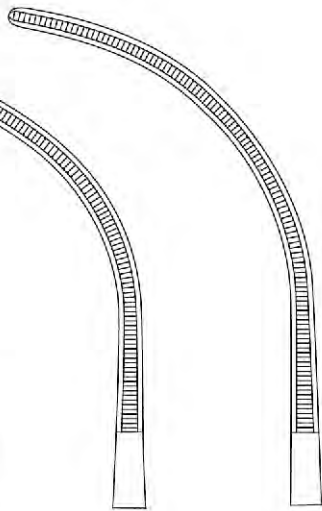




GLOVER



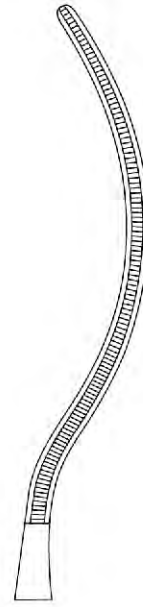
Ai 19-5539-21
21.0cm



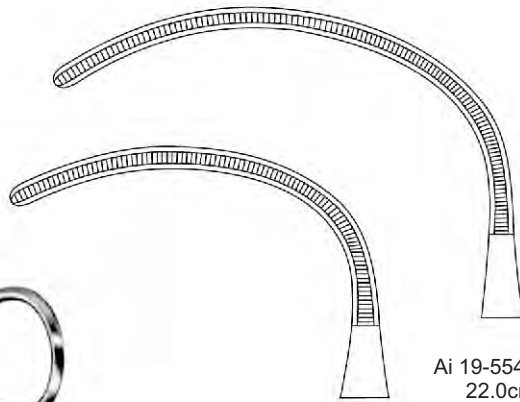
Ai 19-5539-24
24.0cm



Ai 19-5540-21
21.0cm



Ai 19-5540-26
26.0cm



Ai 19-5541-18
18.0cm

Ai 19-5541-22
22.0cm

Dissecting and
Ligature Forceps



De Bakey



Ai 19-5543-19
19 cm/8"



Ai 19-5543-23
23 cm/9 1/2"



De Bakey



Ai 19-5544-20
20 cm/8"



Ai 19-5544-18
18 cm/7 1/2"



De Bakey



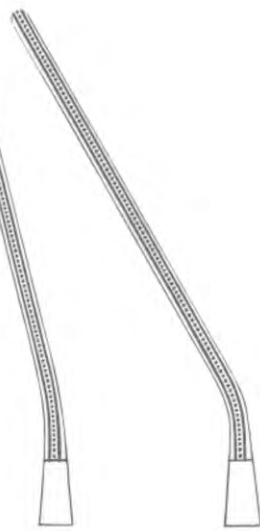
Leland-Jones



Ai 19-5545-01
19.5 cm/7 1/2"



Ai 19-5545-02
19.5 cm/7 1/2"



Ai 19-5545-03
19.5 cm/7 1/2"



Leland-Jones
Ai 19-5546-18
18 cm/7"





Aortic Aneurysm Clamps



De Bakey



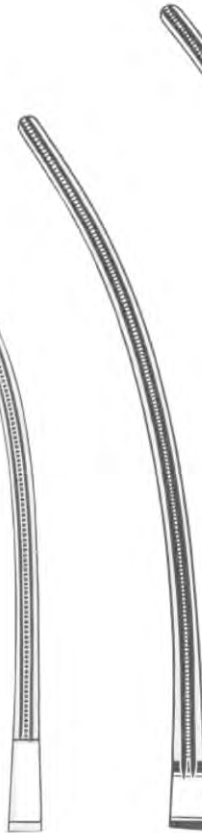
De Bakey



Ai 19-5547-24
26 cm/10 1/2"



Ai 19-5547-27
27 cm/10 1/2"



Ai 19-5547-31
31 cm/12 1/4"



Ai 19-5547-33
33 cm/13 1/4"



De Bakey-Bainbirdge



Ai 19-5548-15
15 cm/6"



Ai 19-5548-18
18 cm/7"



Ai 19-5549-15
15 cm/6"



Ai 19-5549-18
18 cm/7"



De Bakey
Ai 19-5549-20
20 cm/8"

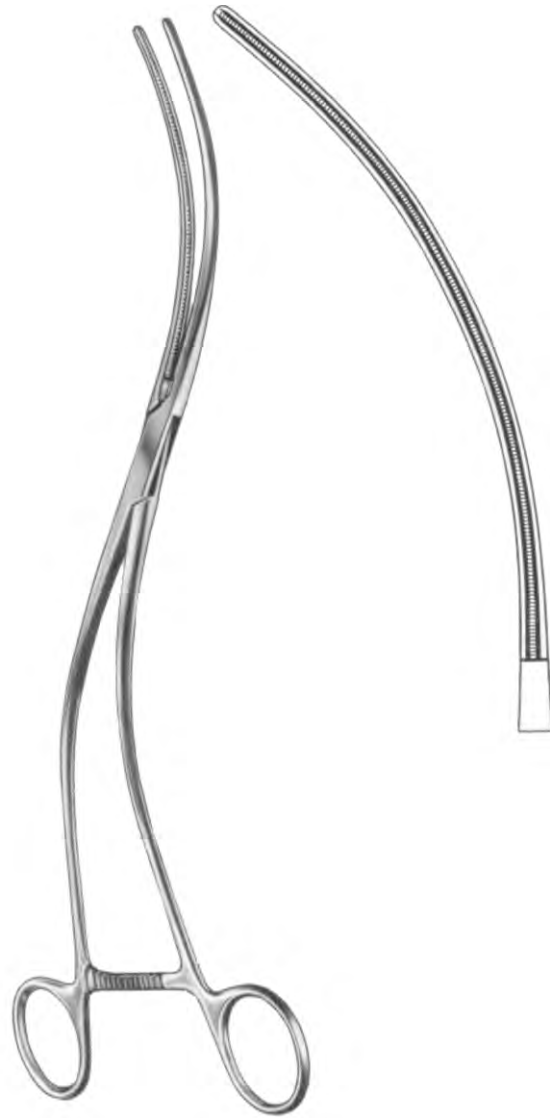


De Bakey

Aortic Aneurysm Clamps



De Bakey
Ai 19-5550-28
28 cm/11"



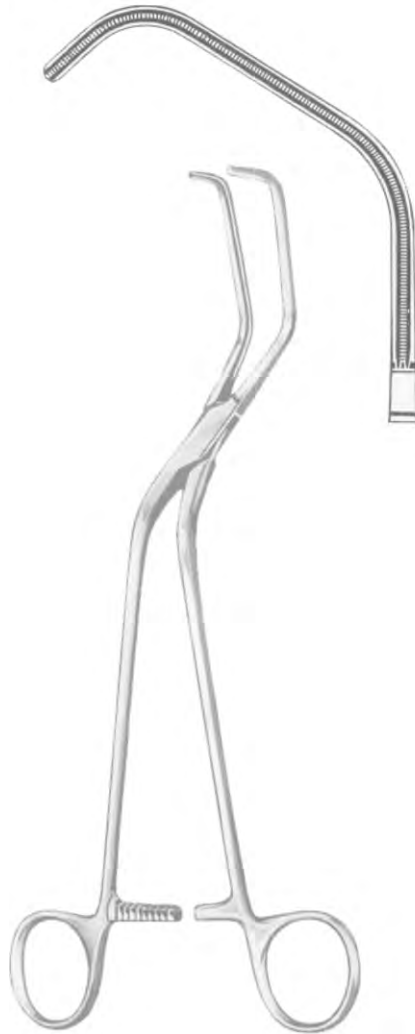
Ai 19-5551-30
30 cm/12"



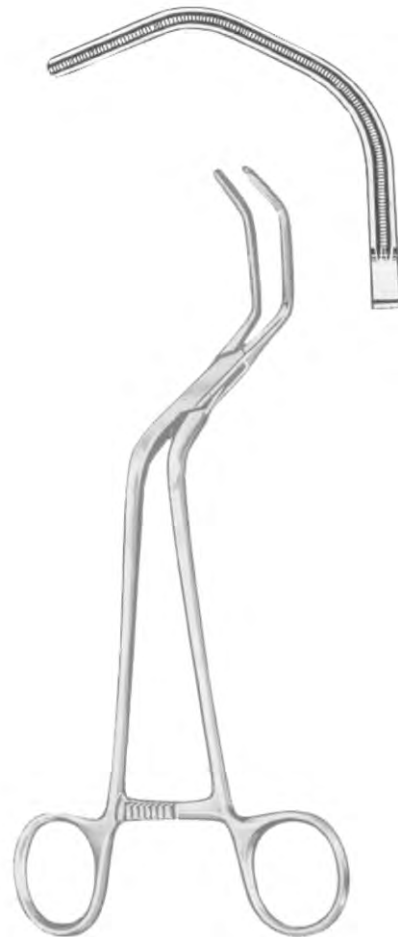


De Bakey

Aortic Clamps



Ochsner
 Ai 19-5552-23
 23.5 cm/9¼"



Dietrich
 Ai 19-5553-21
 21 cm/8¼"



De Bakey



Ai 19-5554-01
24 cm/9½"



Ai 19-5554-02
24 cm/9½"

Auricle Clamp



Harken



Ai 19-5554-03
24 cm/9½"



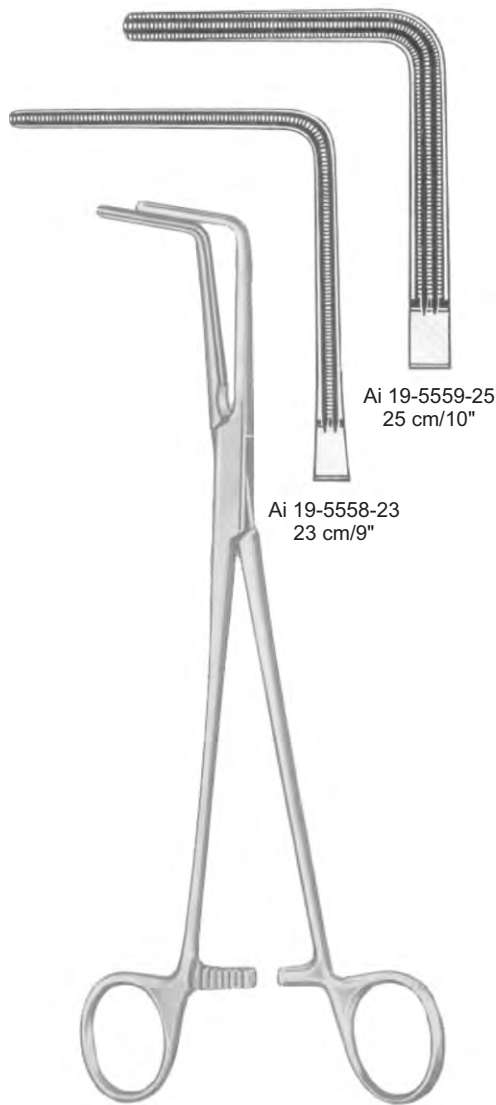
Ai 19-5554-04
24 cm/9½"





De Bakey

Bronchus Clamps



Lees

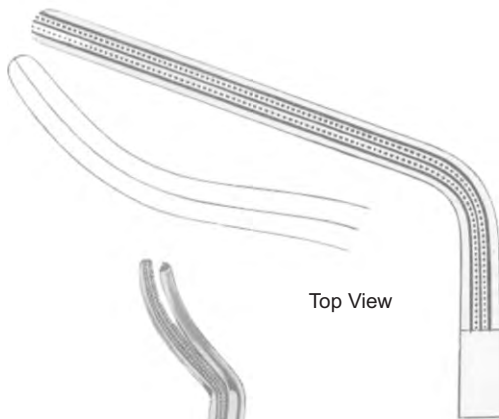


Lees
Ai 19-5560-25
25 cm/10"



De Bakey

Aortic Clamp



Top View

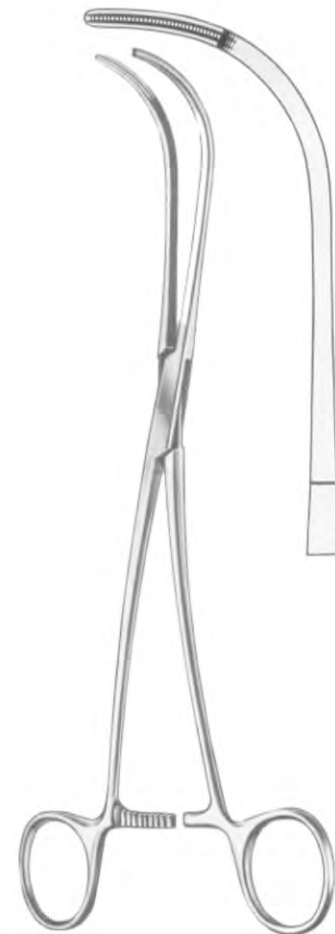


De Bakey
Ai 19-5561-27
27 cm/10½"

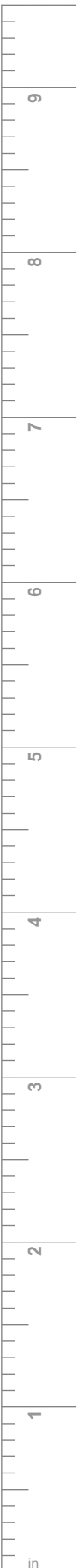


De Bakey
Ai 19-5562-24
24 cm/9½"

Ligature Clamps



De Bakey
Ai 19-5563-24
24 cm/9½"





De Bakey

Ligature clamp,
Aortic clamp

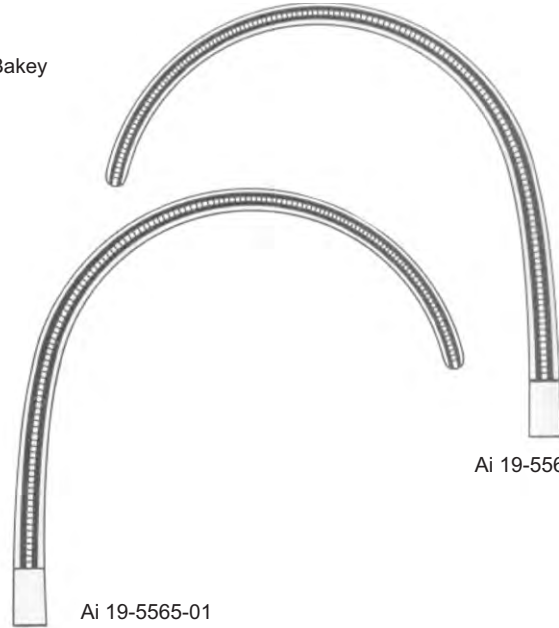


De Bakey
Ai 19-5564-26
26.5 cm/10½"

De Bakey-Semb
Ai 19-5564-25
25 cm/10"



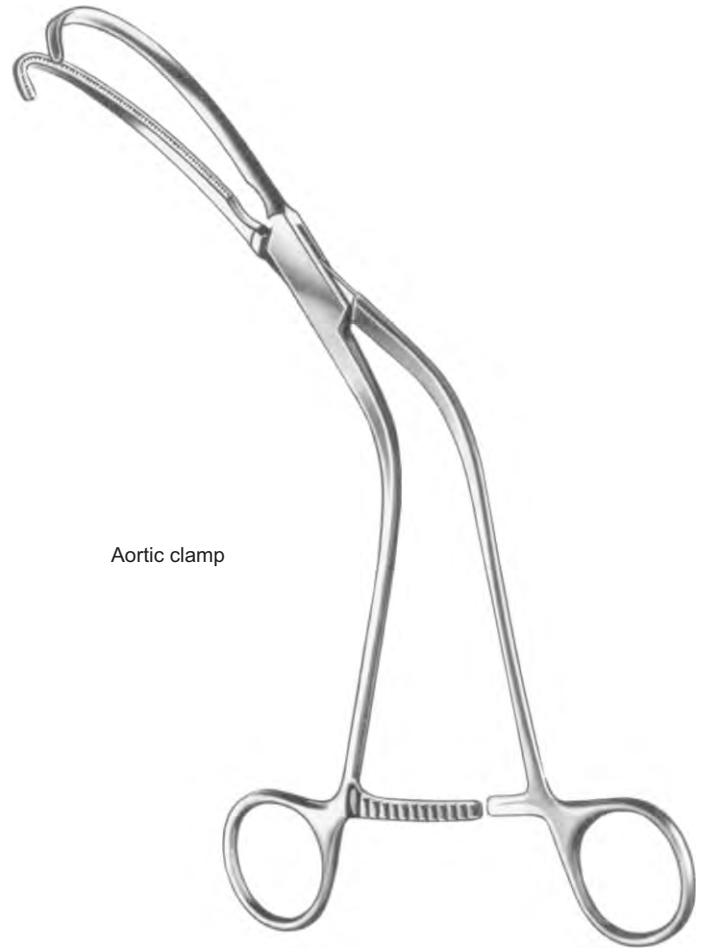
De Bakey-Semb



Ai 19-5565-01

Ai 19-5565-02

Aortic clamp



Weber
26 cm/10¼"

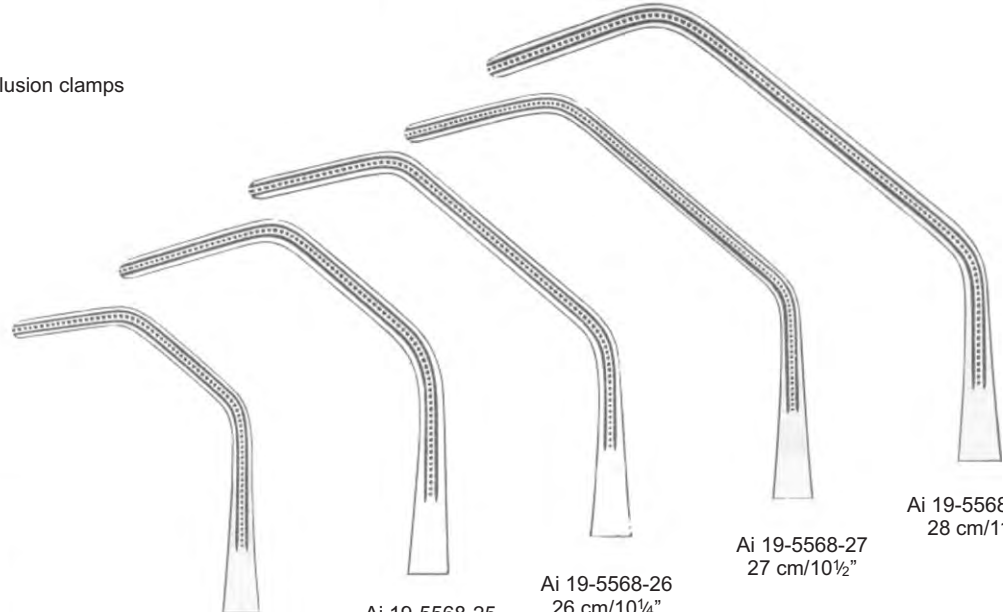


Satinsky/De Bakey

Tangential occlusion clamps



De Bakey



Set of 5 purchase.
Ai 19-5568-00

Ai 19-5568-20
20 cm/8"

Ai 19-5568-25
25 cm/10"

Ai 19-5568-26
26 cm/10 1/4"

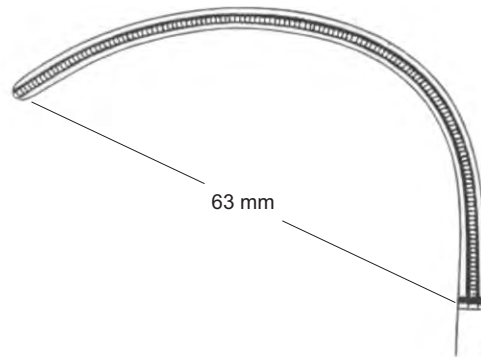
Ai 19-5568-27
27 cm/10 1/2"

Ai 19-5568-28
28 cm/11"



Glover

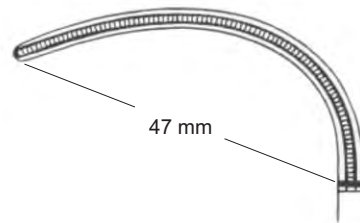
Ai 19-5569-01 19.5 cm/7 3/4"
 Ai 19-5569-02 21.0 cm/8 1/4"



Anastomosis

63 mm

Ai 19-5569-01



47 mm

Ai 19-5569-02



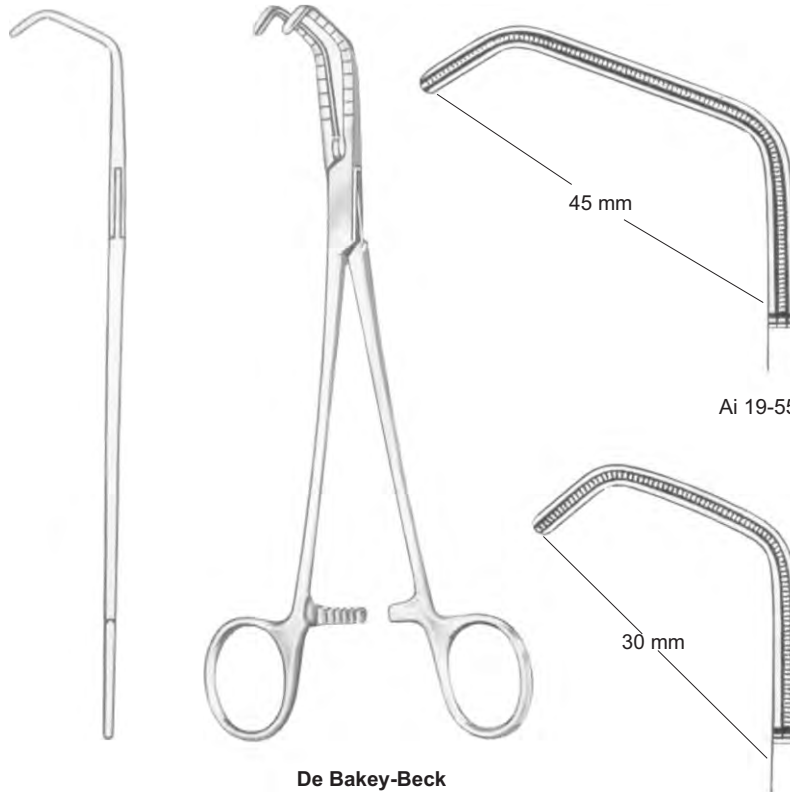


De Bakey



De Bakey
 Ai 19-5570-16
 16 cm/6 1/4"

Graduated



De Bakey-Beck
 Ai 19-5571-01 20.5 cm/8"
 Ai 19-5571-02 21.0 cm/8 1/4"

Ai 19-5571-02

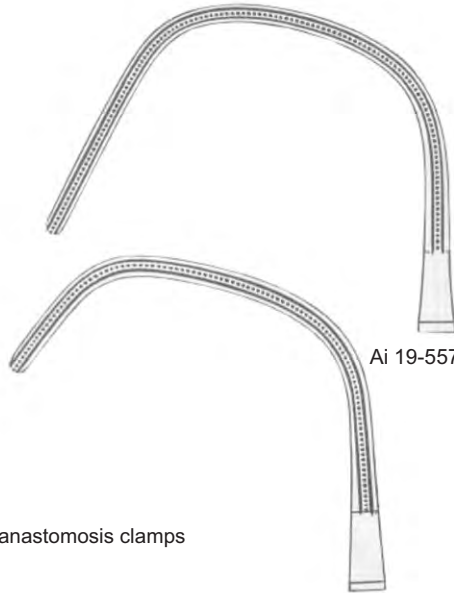
Ai 19-5571-01



De Bakey



Lambert-Kay
21 cm/8¼"



Aortic anastomosis clamps

Ai 19-5572-21

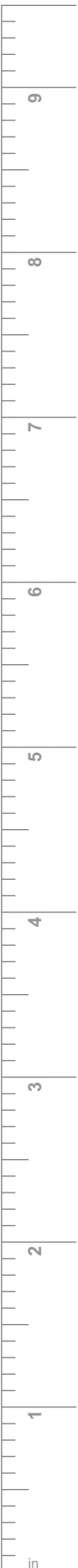
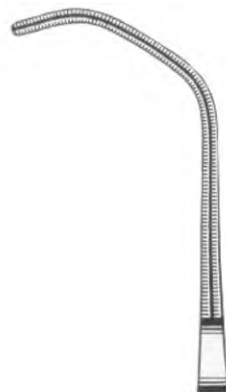
Ai 19-5572-22



De Bakey
Ai 19-5573-17
17 cm/6¾"



Beck
Ai 19-5574-17
17 cm/6¾"





De Bakey



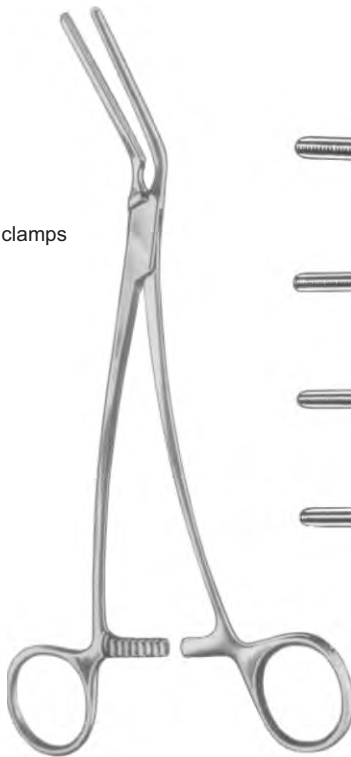
Ai 19-5575-20
20 cm/8"

Ai 19-5575-22
22 cm/8 3/4"

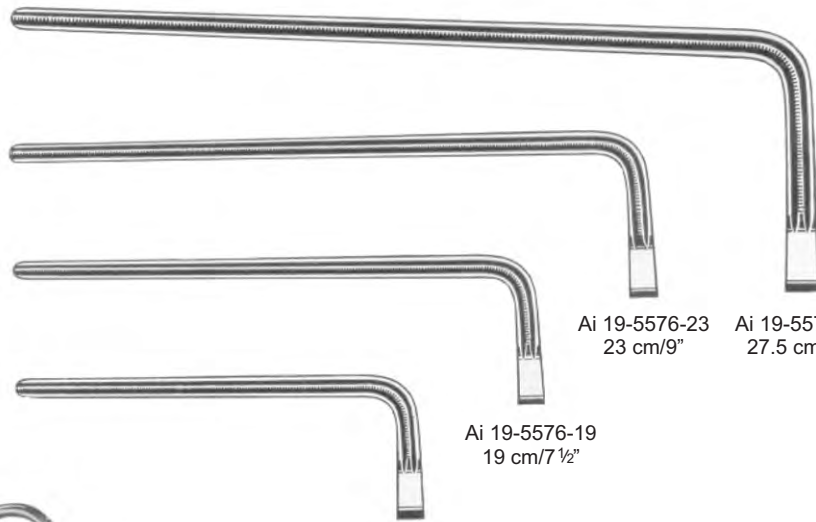
Ai 19-5575-24
24 cm/9 1/2"

Ai 19-5575-30
30.5 cm/12"

Multi purpose clamps



De Bakey

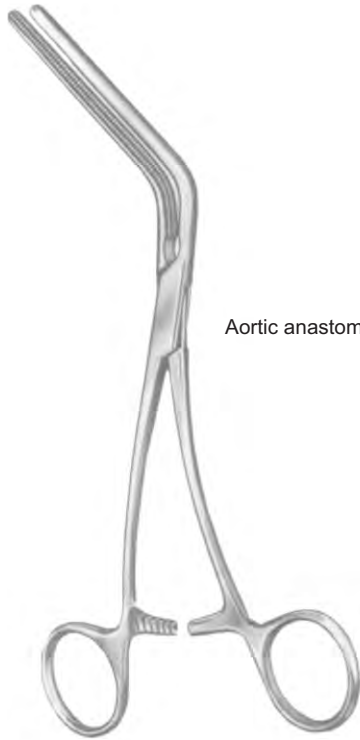


Ai 19-5576-18
18 cm/7"

Ai 19-5576-19
19 cm/7 1/2"

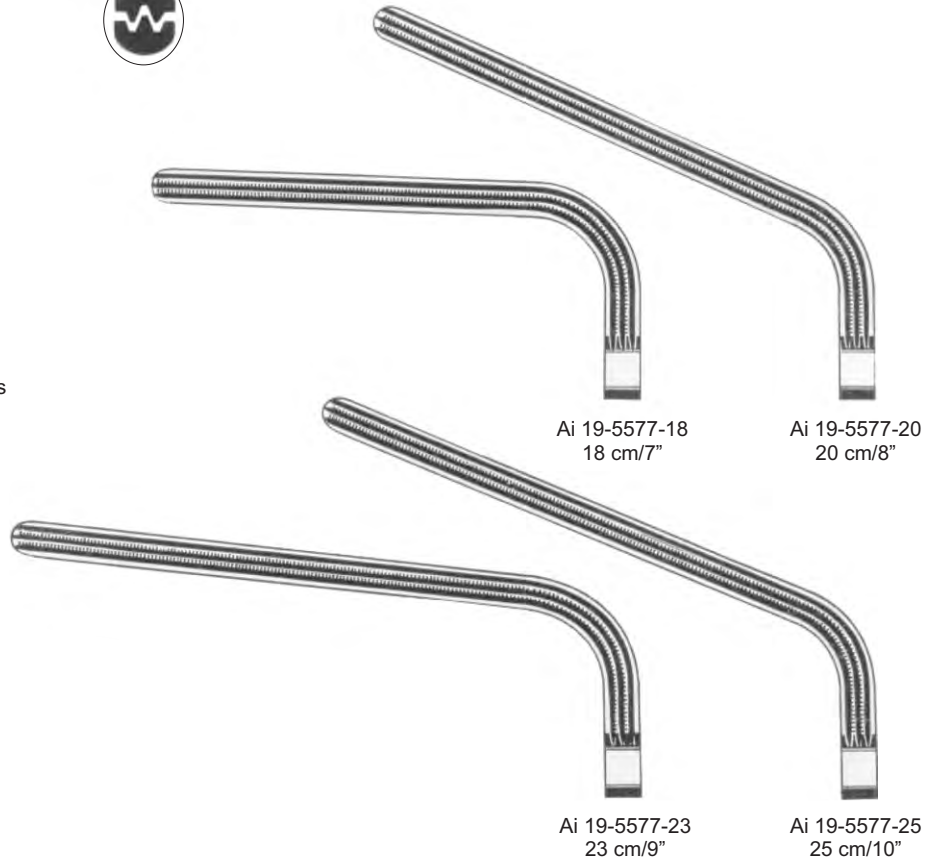
Ai 19-5576-23
23 cm/9"

Ai 19-5576-27
27.5 cm/11"



Aortic anastomosis clamps

Morris-De Bakey



Ai 19-5577-18
18 cm/7"

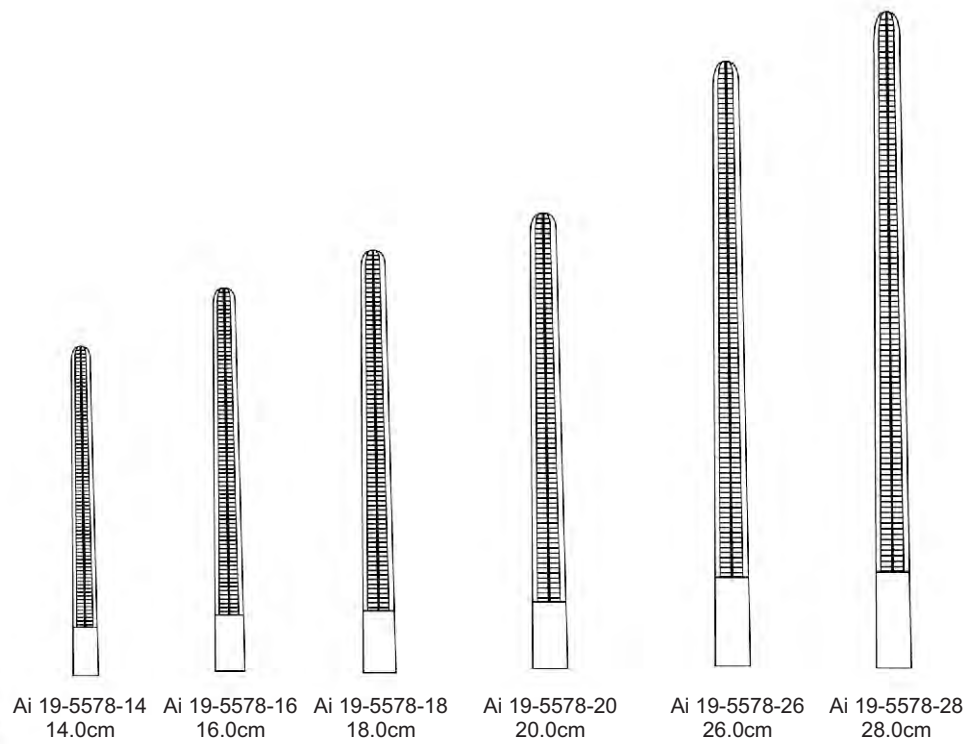
Ai 19-5577-20
20 cm/8"

Ai 19-5577-23
23 cm/9"

Ai 19-5577-25
25 cm/10"



DE BAKEY-PEAN



Ai 19-5578-14
14.0cm

Ai 19-5578-16
16.0cm

Ai 19-5578-18
18.0cm

Ai 19-5578-20
20.0cm

Ai 19-5578-26
26.0cm

Ai 19-5578-28
28.0cm





Aorta aneurysm clamps



De Bakey



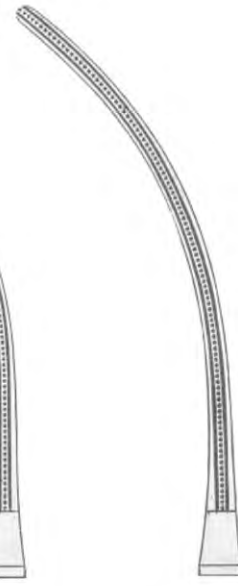
De Bakey-Bahnson



Ai 19-5579-23
23 cm/9"



Ai 19-5579-24
24 cm/9½"



Ai 19-5579-25
25 cm/10"



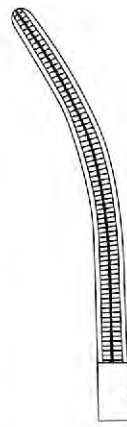
DE BAKEY-PEAN



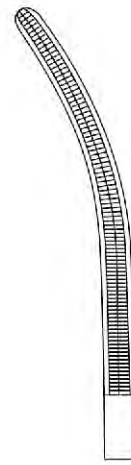
Ai 19-5580-14
14.0cm



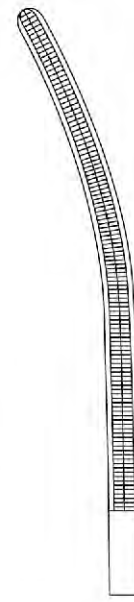
Ai 19-5580-16
16.0cm



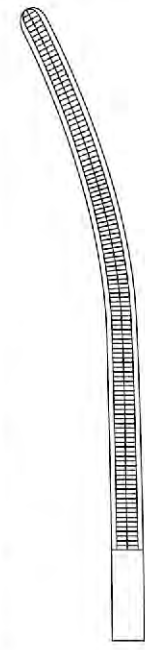
Ai 19-5580-18
18.0cm



Ai 19-5580-20
20.0cm



Ai 19-5580-26
26.0cm



Ai 19-5580-28
28.0cm

Multi purpose clamps



De Bakey



De Bakey-Rankin



Ai 19-5581-16
16 cm/6¼"



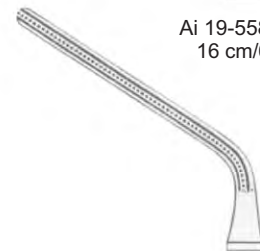
Ai 19-5582-16
16 cm/6¼"



Cooley



Ai 19-5583-16
16 cm/6¼"



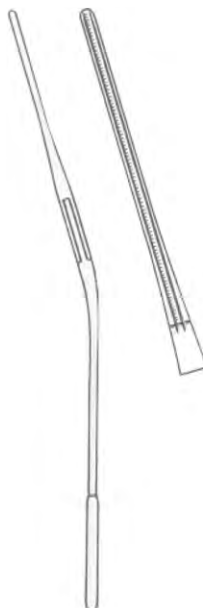
Ai 19-5583-15
15.5 cm/6"



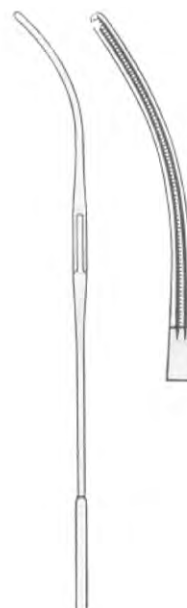
Ai 19-5583-14
14.5 cm/5¾"



De Bakey
 Ai 19-5584-17
 17 cm/6¾"



Ai 19-5585-17



Ai 19-5586-17



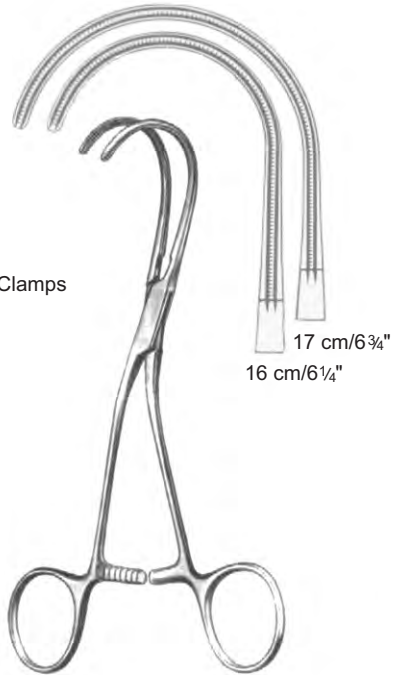
Ai 19-5587-17





De Bakey

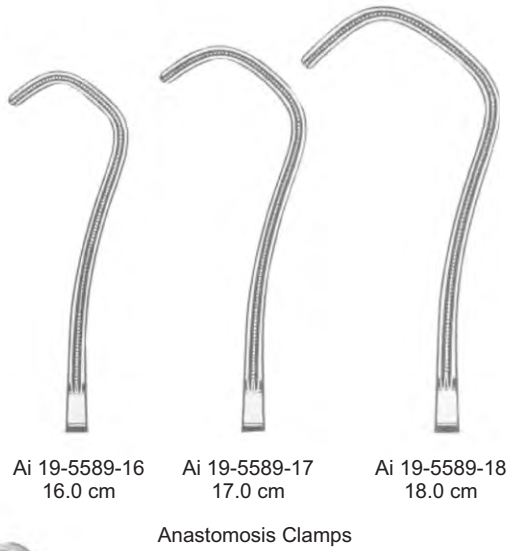
Ligature Clamps



Ai 19-5588-16 16cm/6¼"
 Ai 19-5588-17 17cm/6¾"



Derra-De Bakey



Ai 19-5589-16 16.0 cm Ai 19-5589-17 17.0 cm Ai 19-5589-18 18.0 cm

Anastomosis Clamps

Profunda Clamps



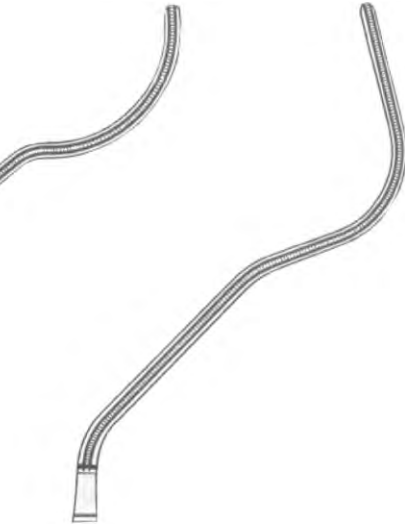
Gregory



Ai 19-5590-14
 14 cm/5½"



Ai 19-5590-16
 16 cm/6¼"



Ai 19-5590-18
 18 cm/7"

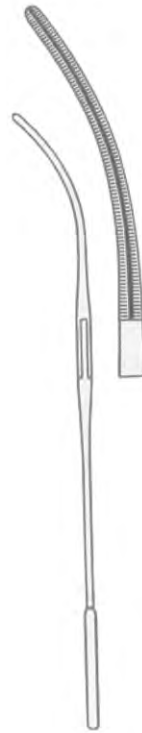


Cooley

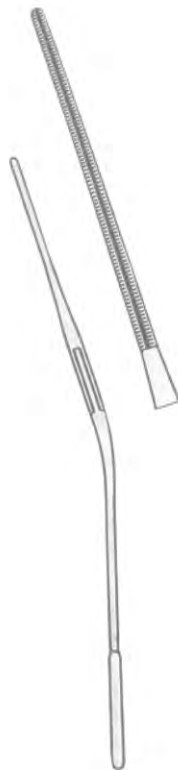
Coarctation Clamps



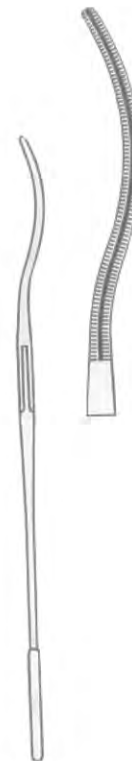
Cooley
Ai 19-5591-17
17 cm/6¾"



Cooley
Ai 19-5592-17
17 cm/6¾"



Cooley
Ai 19-5593-17
17 cm/6¾"



Cooley
Ai 19-5594-17
17 cm/6¾"





Cooley



Cooley
 Ai 19-5595-20
 20 cm/8"



Cooley



Cooley
 Ai 19-5599-17
 17 cm/6 3/4"



Ai 19-5596-03
 17 cm/6 3/4"



Ai 19-5596-02
 15.5 cm/6"



Ai 19-5596-01
 15 cm/6"

Anastomosis clamps



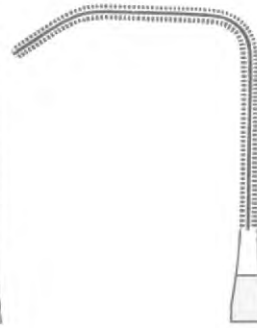
Cooley



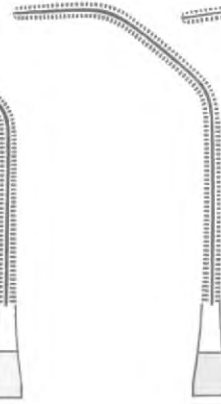
Cooley



Ai 19-5600-01
 16.5 cm/6½"



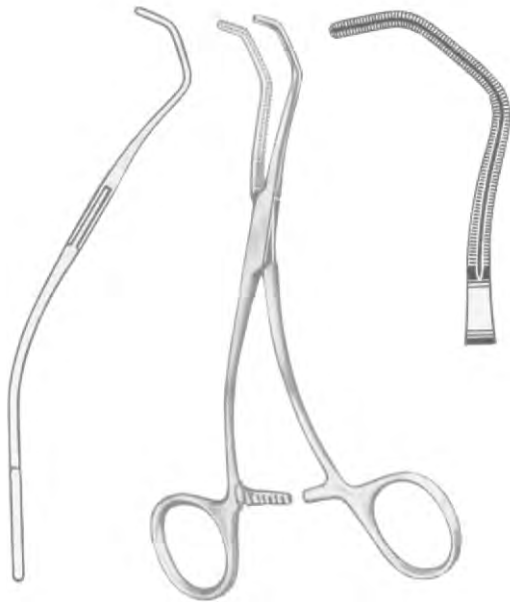
Ai 19-5600-02
 16.5 cm/6½"



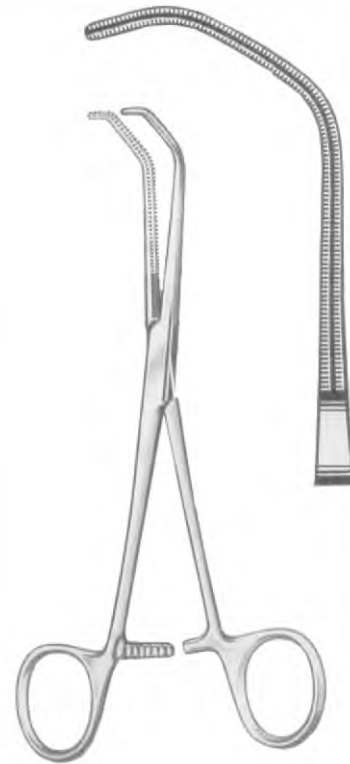
Ai 19-5600-03
 17.5 cm/7"



Ai 19-5600-04
 17.5 cm/7"



Cooley
 Ai 19-5601-16
 16 cm/6¼"



Beck
 Ai 19-5602-17
 17 cm/6¾"





Cooley



Cooley-Derra

Ai 19-5603-16
 16 cm/6 1/4"



Ai 19-5603-17
 17 cm/6 3/4"



Ai 19-5603-18
 18 cm/7"



Cooley

Ai 19-5604-16 16 cm/6 1/4"
 Ai 19-5604-17 17 cm/6 3/4"



16 cm/6 1/4"

17 cm/6 3/4"

Ligature clamps



Cooley



Cooley
14 cm/5½"

Ai 19-5605-14 Ai 19-5606-14



Cooley
Ai 19-5607-14
14 cm/5½"



Cooley
Ai 19-5608-14
14 cm/5½"



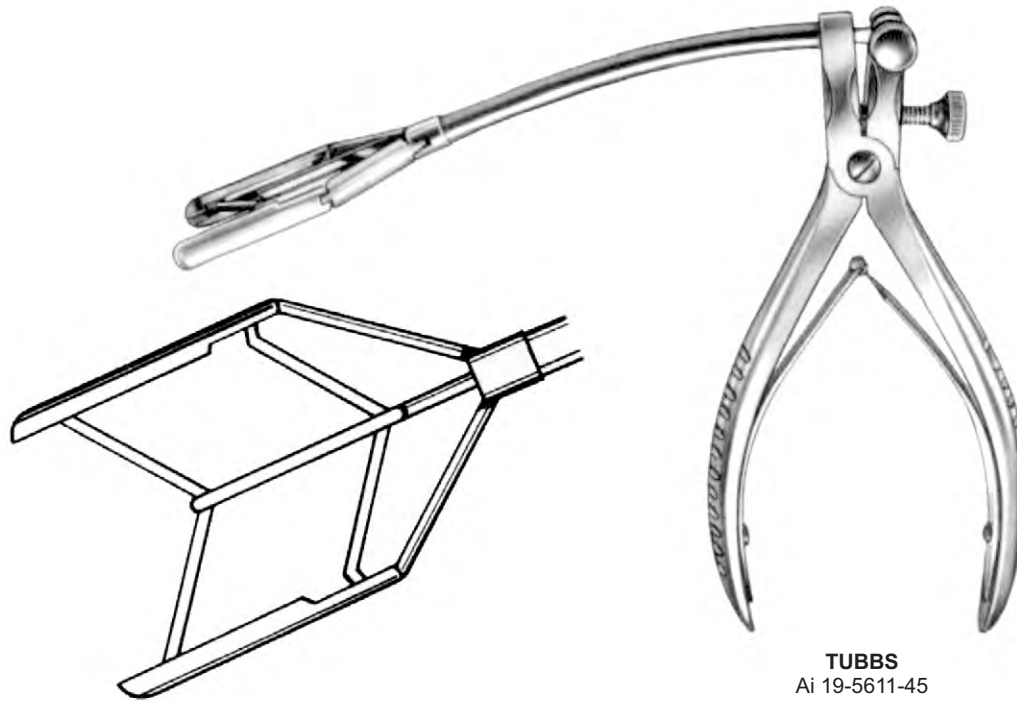
Cooley
Ai 19-5609-14
14 cm/5½"





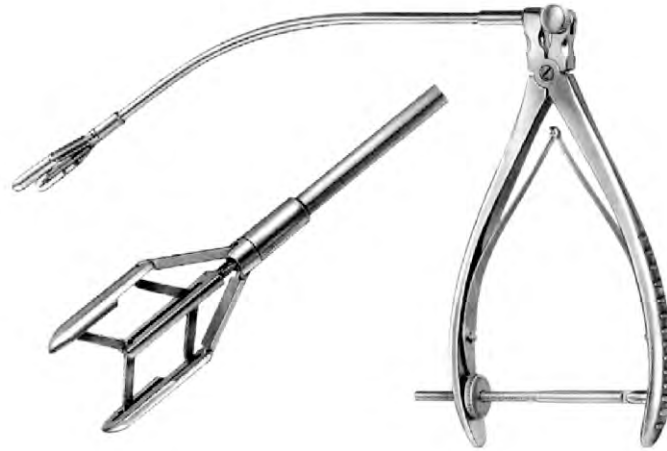
blade opening from 8 to 42 mm

TUBBS
Ai 19-5610-42



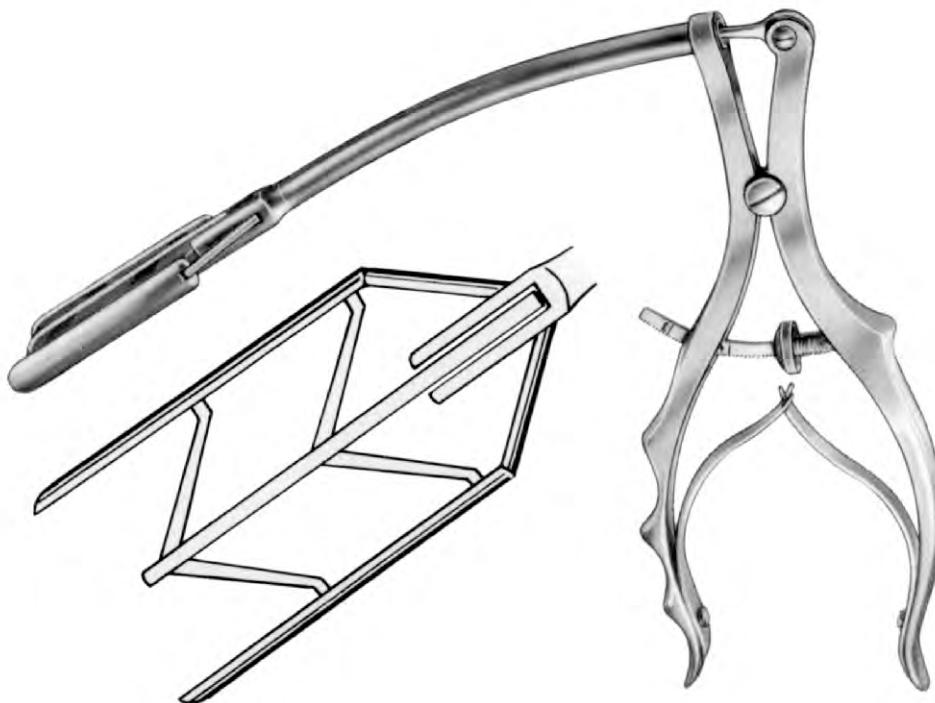
blade opening from 9 to 45 mm

TUBBS
Ai 19-5611-45



blade opening from 8 to 15 mm
blade opening from 8 to 45 mm

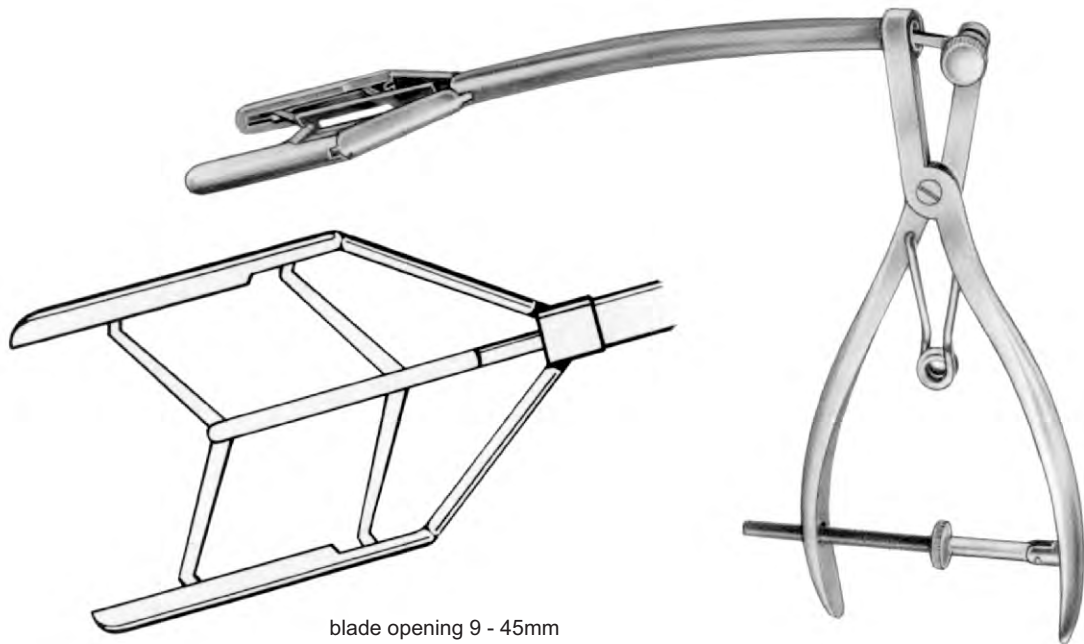
COOLEY
Ai 19-5612-15
Ai 19-5612-45



COOLEY
Ai 19-5613-40
blade opening 9 - 40mm

COOLEY-DEBAKEY
Ai 19-5614-30
blade opening 7 - 30mm





blade opening 9 - 45mm

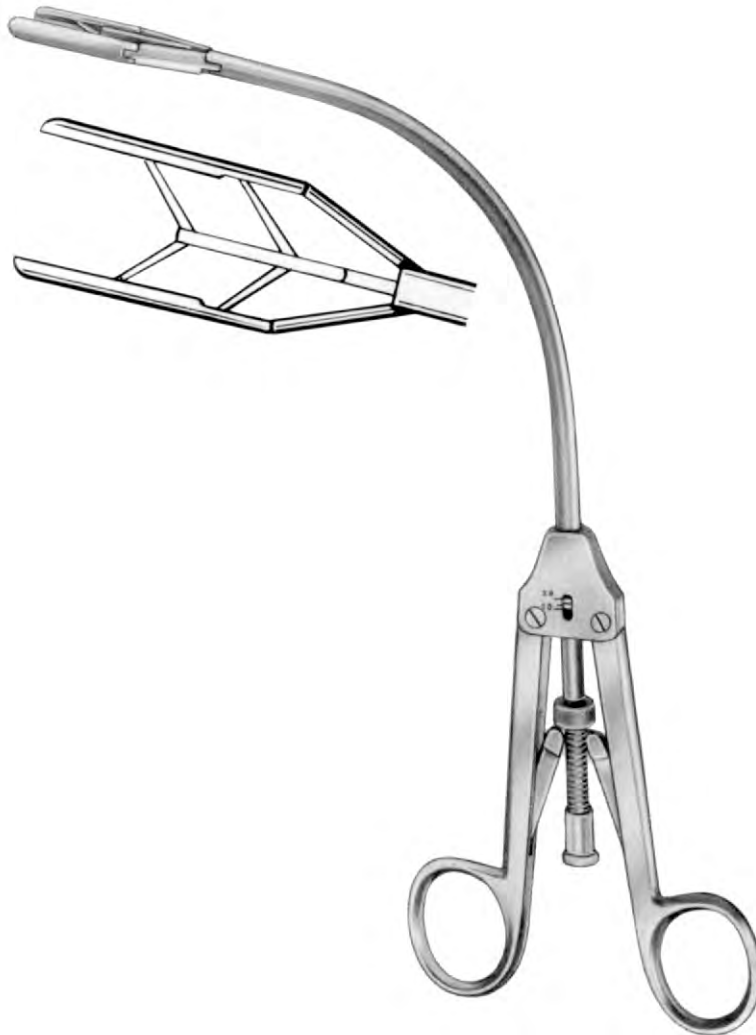
GERBODE
 Ai 19-5615-45





Blade opening 4 - 10mm

HETZER
Ai 19-5616-10



COOLEY blade opening
Ai 19-5617-18 5 - 18mm
Ai 19-5617-20 6 - 20mm





DE BAKEY

19.0cm
35.0cm

Ai 19-5619-05
Ai 19-5620-05
0.5mm Ø

Ai 19-5619-10
Ai 19-5620-10
1mm Ø

Ai 19-5619-15
Ai 19-5620-15
1.5mm Ø

Ai 19-5619-20
Ai 19-5620-20
2mm Ø

Ai 19-5619-25
Ai 19-5620-25
2.5mm Ø

Ai 19-5619-30
Ai 19-5620-30
3mm Ø

19.0cm
35.0cm

Ai 19-5619-35
Ai 19-5620-35
3.5mm Ø

Ai 19-5619-40
Ai 19-5620-40
4mm Ø

Ai 19-5619-45
Ai 19-5620-45
4.5mm Ø

Ai 19-5619-50
Ai 19-5620-50
5mm Ø

Ai 19-5619-70
Ai 19-5620-70
7mm Ø

Ai 19-5619-90
Ai 19-5620-90
9mm Ø

Malleable



Cooley
13 cm/5"

Ai 19-5621-05
0.5 mm Ø

Ai 19-5621-10
1.0 mm Ø

Ai 19-5621-15
1.5 mm Ø

Ai 19-5621-20
2.0 mm Ø

Ai 19-5621-25
2.5 mm Ø

Ai 19-5621-30
3.0 mm Ø

Ai 19-5621-40
4.0 mm Ø

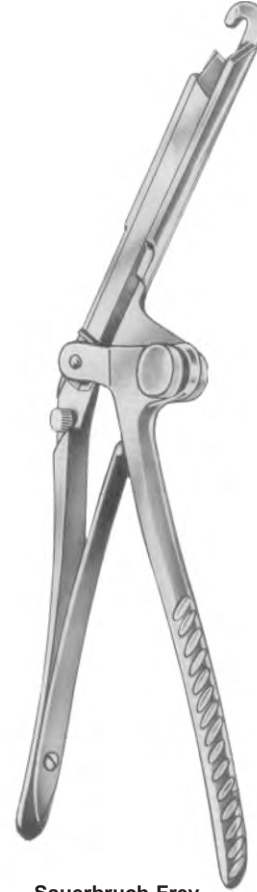
Ai 19-5621-50
5.0 mm Ø



Sauerbruch
 Ai 19-5622-26
 26 cm/10 1/4"



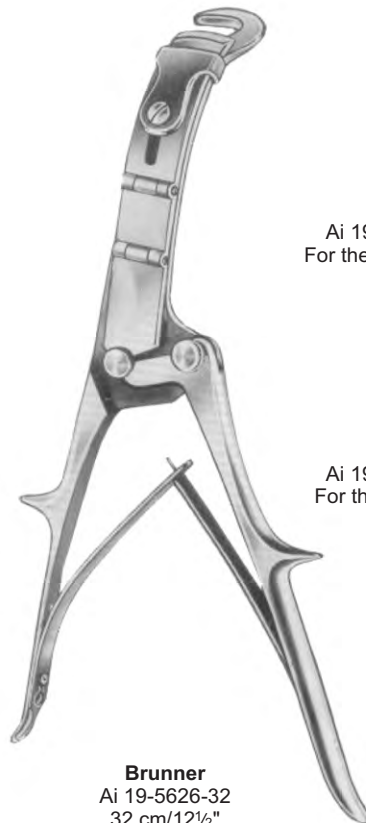
Giertz-Stille
 Ai 19-5623-27
 27 cm/10 1/2"



Sauerbruch-Frey
 Ai 19-5624-36
 36 cm/14"



Bethune
 Ai 19-5625-34
 34 cm/13 1/2"



Brunner
 Ai 19-5626-32
 32 cm/12 1/2"

Ai 19-5626-32
 For the Right Hand

Ai 19-5627-32
 For the left Hand

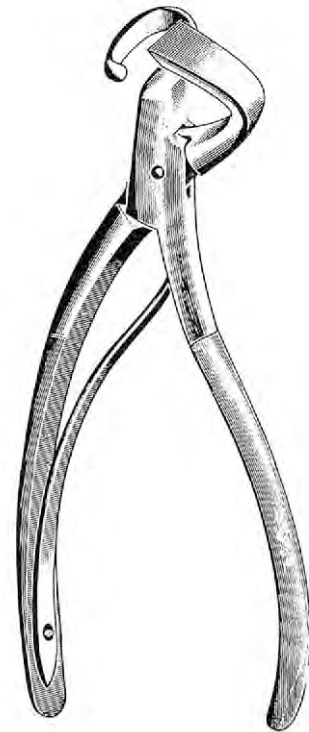


Lebsche
 Ai 19-5628-24
 24.5 cm/9 3/4"





CORYLLOS
 Ai 19-5629-35
 35.0cm



DOYEN
 Ai 19-5630-19
 19.0cm



BETHUNE-NELSON
Ai 19-5631-34
34.0cm
with probe ended blades



ROBERTS
Ai 19-5632-34
34.0cm
with angular probe ended blades



ROBERTS
Ai 19-5633-34
34.0cm
with angular probe ended blades of first and second ribs





SCHUMACHER
 Ai 19-5634-20
 20.0cm

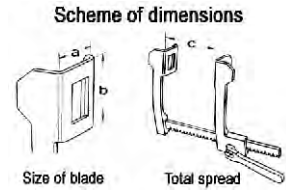


TUDOR EDWARDS
 Ai 19-5635-23
 23.0cm



LEBSCHE
Ai 19-5636-25
25.0cm





**CASTAÑEDA
 S/S**

	ALU	a	b	c
Ai 19-5637-01	Ai 19-5637-11	10.5mm	32mm	65mm
Ai 19-5637-02	Ai 19-5637-12	16mm	30mm	65mm



**CASTAÑEDA
 S/S**

	ALU	a	b	c
Ai 19-5638-01	Ai 19-5638-11	12mm	45mm	70mm



**CASTAÑEDA
 S/S**

	ALU	a	b	c
Ai 19-5639-01	Ai 19-5639-11	15mm	60mm	120mm



COOLEY

S/S	ALU	a	b	c
Ai 19-5640-01	Ai 19-5640-11	12mm	16mm	95mm
Ai 19-5640-02	Ai 19-5640-12	12mm	17mm	75mm
Ai 19-5640-03	Ai 19-5640-13	14mm	16mm	85mm



COOLEY

S/S	ALU	a	b	c
Ai 19-5641-01	Ai 19-5641-11	15mm	30mm	115mm
Ai 19-5641-02	Ai 19-5641-12	15mm	30mm	140mm
Ai 19-5641-03	Ai 19-5641-13	16mm	30mm	105mm
Ai 19-5641-04	Ai 19-5641-14	20mm	45mm	140mm
Ai 19-5641-05	Ai 19-5641-15	21mm	44mm	150mm
Ai 19-5641-06	Ai 19-5641-16	30mm	35mm	140mm



COOLEY

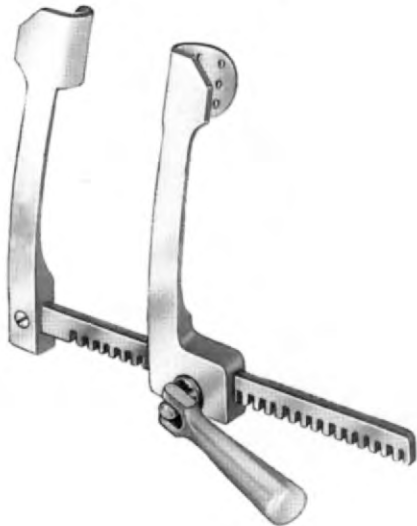
S/S	ALU	a	b	c
Ai 19-5642-01	Ai 19-5642-11	30mm	50mm	185mm
Ai 19-5642-02	Ai 19-5642-12	35mm	50mm	200mm
Ai 19-5642-03	Ai 19-5642-13	37mm	49mm	200mm





COOLEY
for neonatal

S/S	ALU	a	b	c
Ai 19-5643-01	Ai 19-5643-11	12mm	15mm	70mm



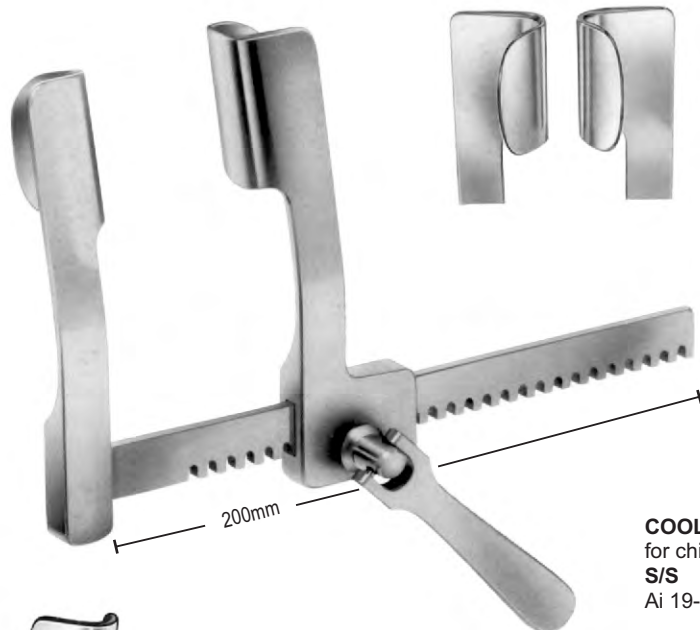
COOLEY
infant, sternal spreader

S/S	ALU	a	b	c
Ai 19-5644-01	Ai 19-5644-11	15mm	20mm	100mm



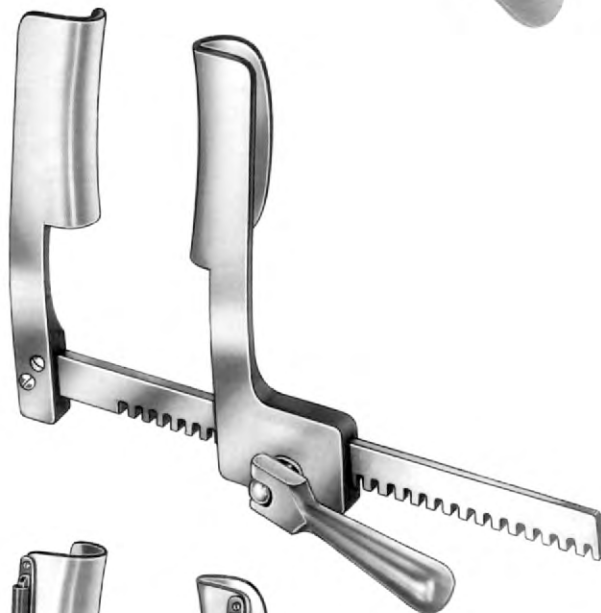
COOLEY
for babies

S/S	ALU	a	b	c
Ai 19-5645-01	Ai 19-5646-01	20mm	25mm	80mm



COOLEY
 for children
S/S **ALU** **a** **b** **c**
 Ai 19-5647-01 Ai 19-5648-01 21mm 45mm 145mm

for adult
 Ai 19-5647-02 Ai 19-5648-02 32mm 50mm 190mm



COOLEY
 for children
S/S **ALU** **a** **b** **c**
 Ai 19-5649-01 Ai 19-5650-01 35mm 100mm 180mm

for adult
 Ai 19-5649-02 Ai 19-5650-02 35mm 115mm 230mm



COOLEY
 for adults with suture separator
S/S **ALU** **a** **b** **c**
 Ai 19-5651-01 Ai 19-5652-01 35mm 100mm 180mm

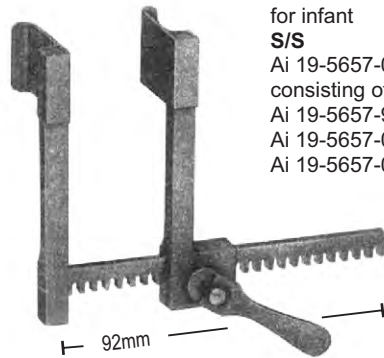




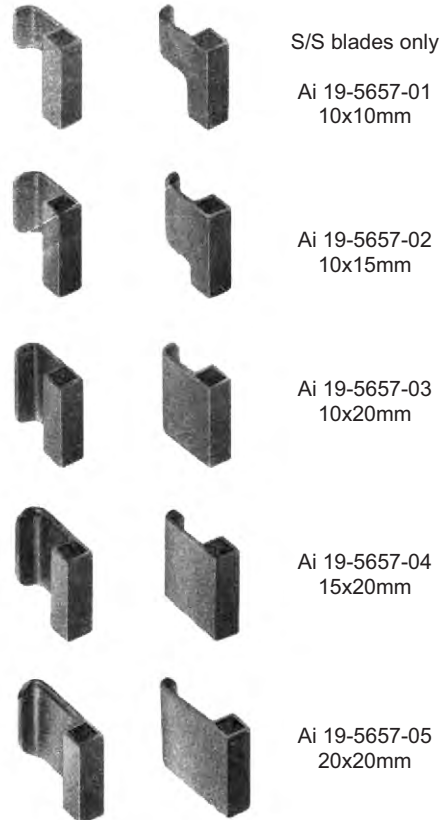
H-COOLEY
 with swivel convex blades, for babies
S/S **ALU** **a** **b** **c**
 Ai 19-5653-01 Ai 19-5654-01 10mm 15mm 90mm



H-COOLEY
 with swivel blades, for babies
S/S **ALU** **a** **b** **c**
 Ai 19-5655-02 Ai 19-5656-02 10mm 15mm 90mm



STRUCK
 for infant
S/S **ALU**
 Ai 19-5657-00 Ai 19-5657-01
 consisting of
 Ai 19-5657-90 spreader only
 Ai 19-5657-04 1 pair
 Ai 19-5657-05 1 pair



S/S blades only

Ai 19-5657-01
 10x10mm

Ai 19-5657-02
 10x15mm

Ai 19-5657-03
 10x20mm

Ai 19-5657-04
 15x20mm

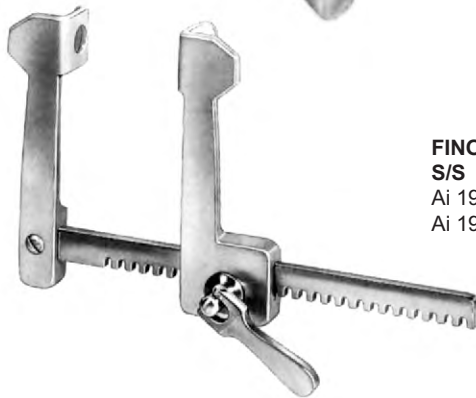
Ai 19-5657-05
 20x20mm





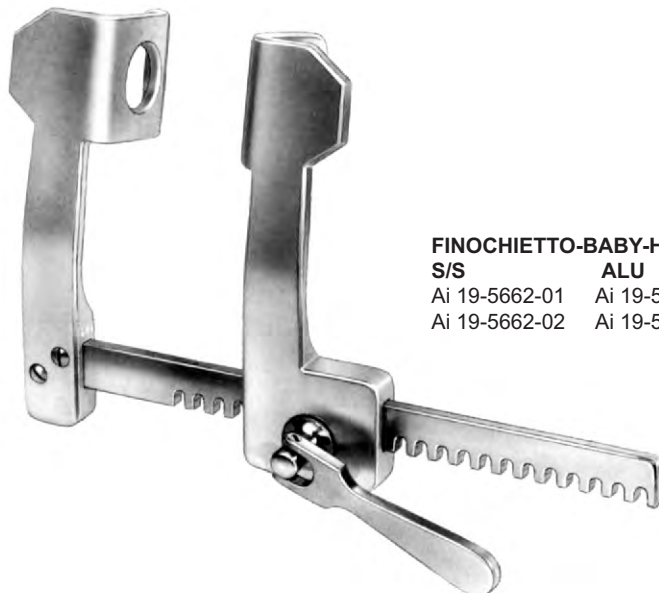
WEINBERG
for children

S/S	ALU	a	b	c
Ai 19-5658-01	Ai 19-5659-01	12mm	20mm	95mm



FINOCHIETTO-INFANT

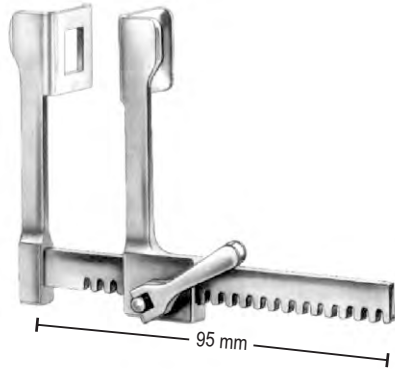
S/S	ALU	a	b	c
Ai 19-5660-01	Ai 19-5661-01	12mm	15mm	70mm
Ai 19-5660-02	Ai 19-5661-02	15mm	15mm	75mm



FINOCHIETTO-BABY-HAIGHT

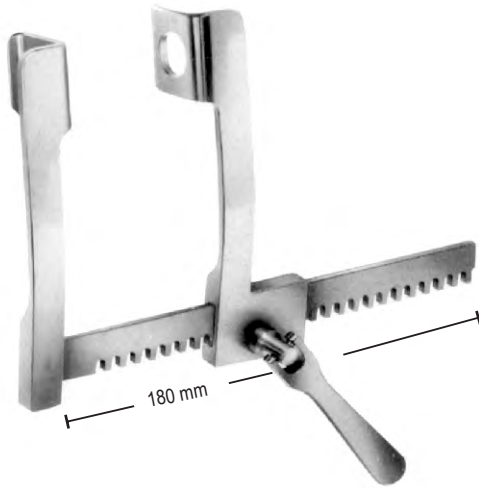
S/S	ALU	a	b	c
Ai 19-5662-01	Ai 19-5663-01	27mm	30mm	95mm
Ai 19-5662-02	Ai 19-5663-02	31mm	31mm	100mm





FINOCHIETTO-BABY

S/S	ALU	a	b	c
Ai 19-5664-01	Ai 19-5665-01	14mm	15mm	75mm
Ai 19-5664-02	Ai 19-5665-02	18mm	20mm	75mm

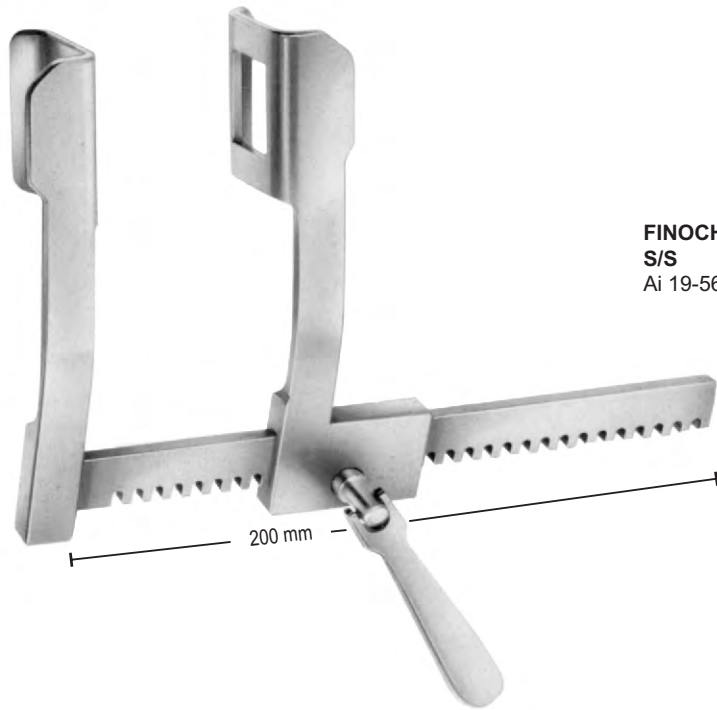


S/S	ALU	a	b	c
Ai 19-5666-01	Ai 19-5667-01	28mm	32mm	120mm

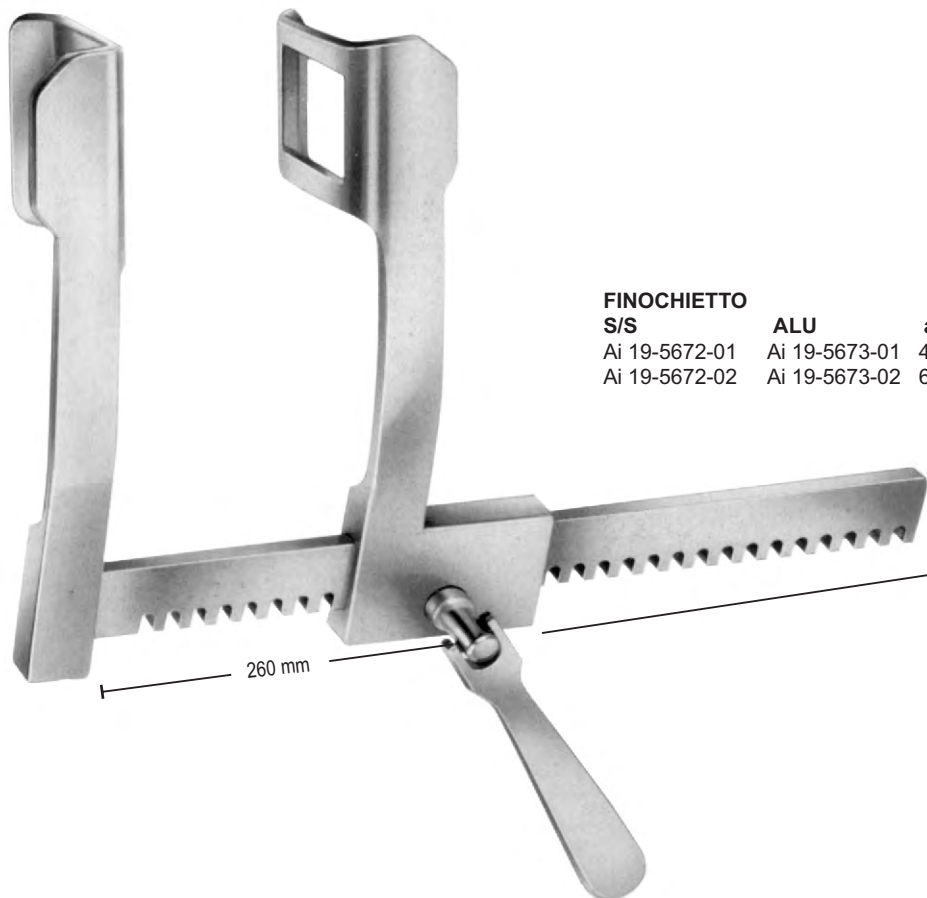


FINOCHIETTO

S/S	ALU	a	b	c
Ai 19-5668-01	Ai 19-5669-01	12mm	15mm	100mm
Ai 19-5668-02	Ai 19-5669-02	28mm	30mm	143mm
Ai 19-5668-03	Ai 19-5669-03	31mm	45mm	210mm
Ai 19-5668-04	Ai 19-5669-04	42mm	61mm	245mm
Ai 19-5668-05	Ai 19-5669-05	74mm	64mm	245mm

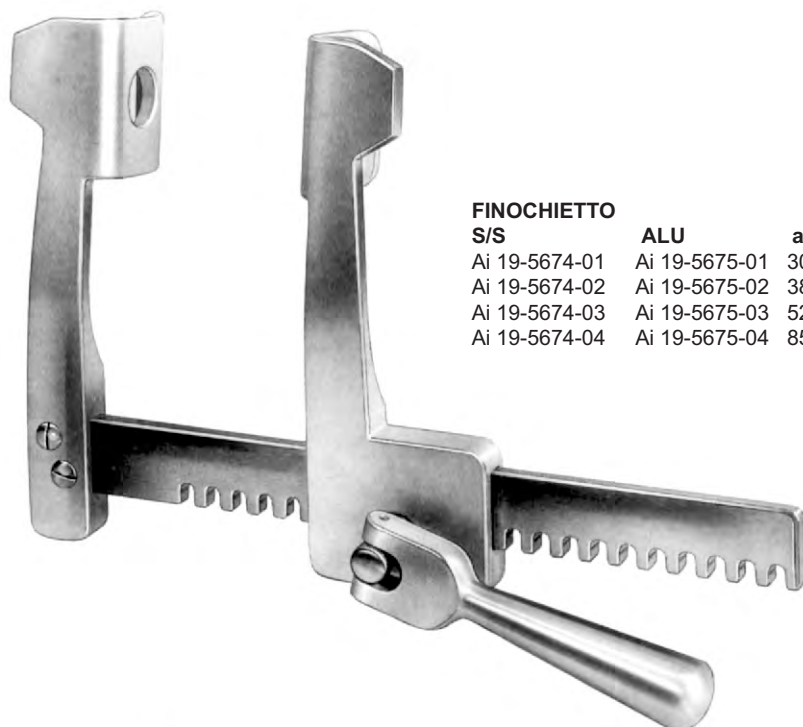


FINOCHIETTO
S/S **ALU** **a** **b** **c**
 Ai 19-5670-01 Ai 19-5671-01 36mm 45mm 140mm

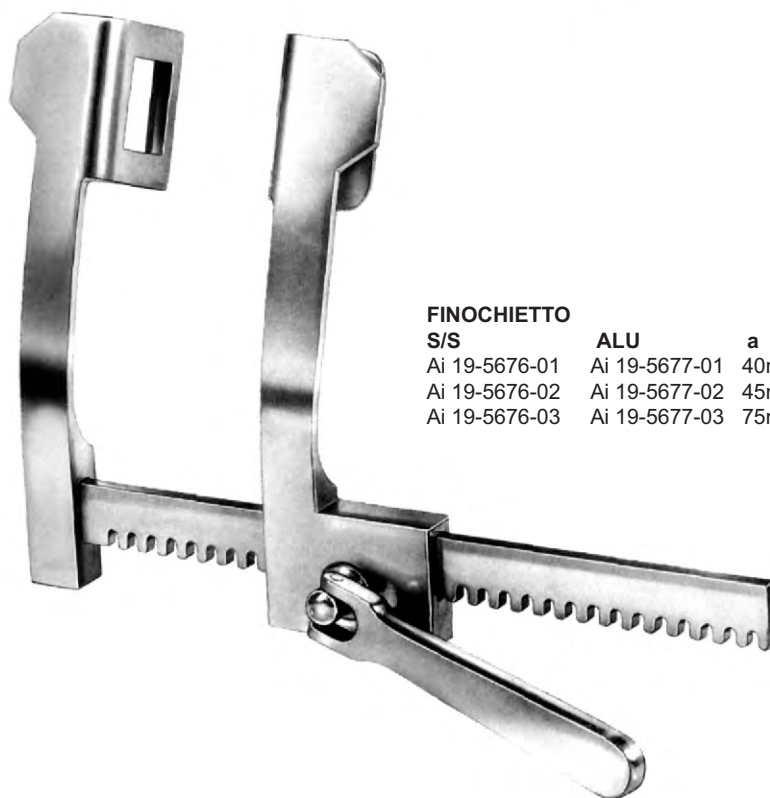


FINOCHIETTO
S/S **ALU** **a** **b** **c**
 Ai 19-5672-01 Ai 19-5673-01 44mm 65mm 210mm
 Ai 19-5672-02 Ai 19-5673-02 65mm 65mm 210mm




**FINOCHIETTO
S/S**

	ALU	a	b	c
Ai 19-5674-01	Ai 19-5675-01	30mm	45mm	140mm
Ai 19-5674-02	Ai 19-5675-02	38mm	44mm	135mm
Ai 19-5674-03	Ai 19-5675-03	52mm	62mm	175mm
Ai 19-5674-04	Ai 19-5675-04	85mm	85mm	175mm


**FINOCHIETTO
S/S**

	ALU	a	b	c
Ai 19-5676-01	Ai 19-5677-01	40mm	40mm	165mm
Ai 19-5676-02	Ai 19-5677-02	45mm	65mm	200mm
Ai 19-5676-03	Ai 19-5677-03	75mm	65mm	250mm



FINOCHIETTO

for adults

S/S	ALU	a	b	c
Ai 19-5678-01	Ai 19-5679-01	52mm	62mm	175mm
Ai 19-5678-02	Ai 19-5679-02	85mm	65mm	175mm



FINOCHIETTO

for adults, with suture separator

S/S	ALU	a	b	c
Ai 19-5680-01	Ai 19-5681-01	85mm	65mm	175mm

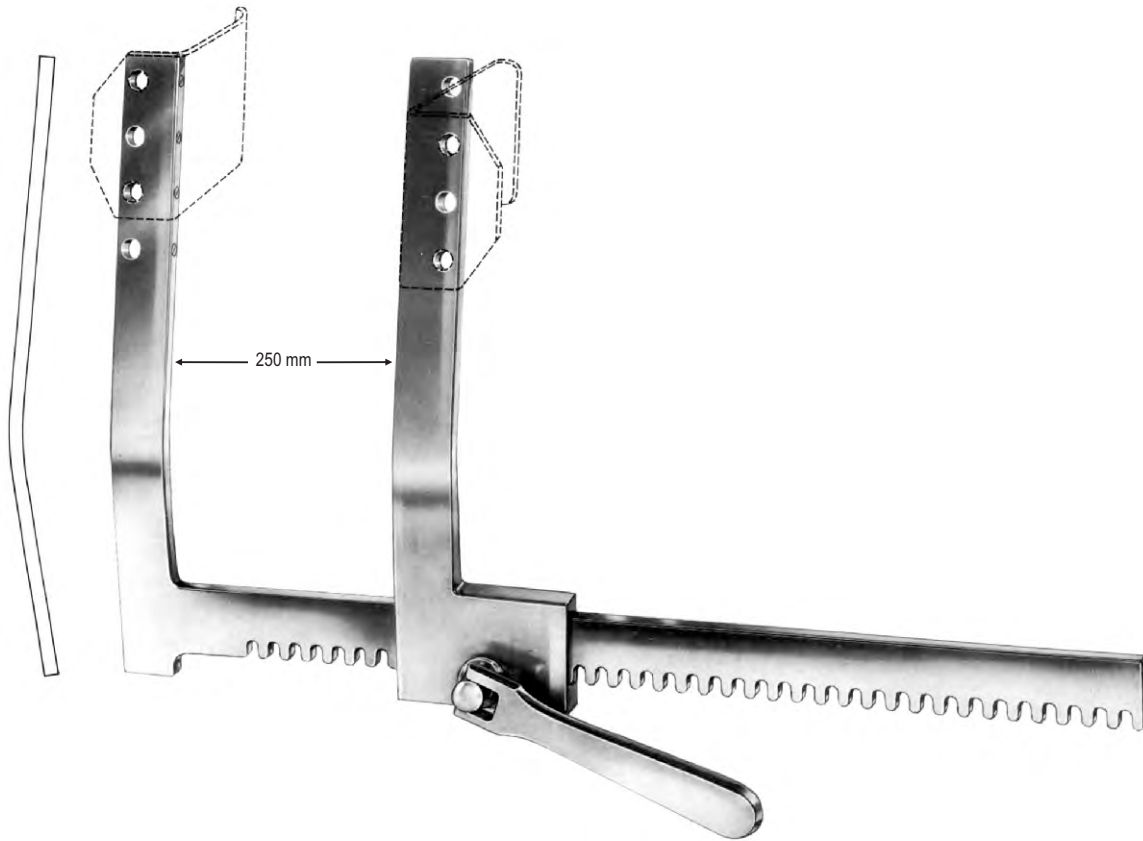


FINOCHIETTO

for adults, with 2 blades attached to each arm

S/S	ALU	a	b	c
Ai 19-5682-01	Ai 19-5683-01	10mm	15mm	120mm
Ai 19-5682-02	Ai 19-5683-02	14mm	14mm	120mm
Ai 19-5682-03	Ai 19-5683-03	14mm	20mm	120mm

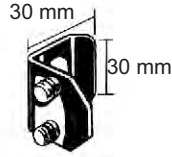




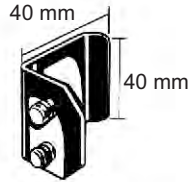
FINOCHIETTO

3 pairs of exchangeable blades

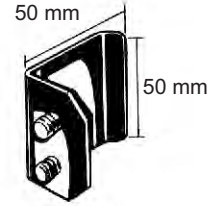
S/S	ALU	S/S	ALU
Ai 19-5684-00 blades	Ai 19-5685-00 blades	Ai 19-5686-00 blades	Ai 19-5687-00 blades
Ai 19-5684-30	Ai 19-5685-30	Ai 19-5686-40	Ai 19-5687-40
Ai 19-5684-40	Ai 19-5685-40	Ai 19-5686-50	Ai 19-5687-50
Ai 19-5684-50	Ai 19-5685-50	Ai 19-5686-60	Ai 19-5687-60
frame only 150mm		frame only 250mm	
Ai 19-5684-01	Ai 19-5685-01	Ai 19-5686-01	Ai 19-5687-01



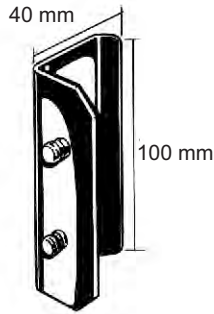
S/S Alu
Ai 19-5684-30 Ai 19-5685-30
30x30mm



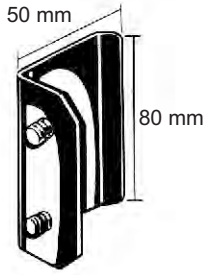
S/S Alu
Ai 19-5684-40 Ai 19-5685-40
40x40mm



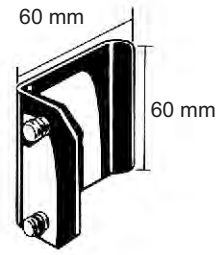
S/S Alu
Ai 19-5684-50 Ai 19-5685-50
50x50mm



S/S Alu
Ai 19-5686-40 Ai 19-5687-40
40x100mm

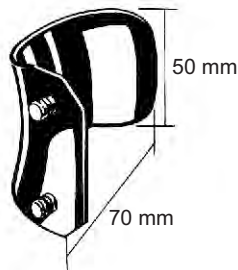


S/S Alu
Ai 19-5686-50 Ai 19-5687-50
50x80mm

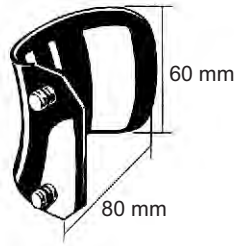


S/S Alu
Ai 19-5686-60 Ai 19-5687-60
60x60mm

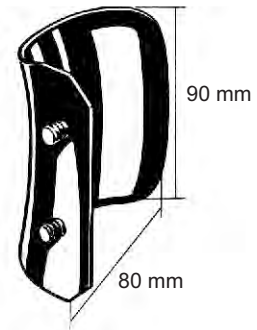
Optional Exchangeable Blades



S/S Alu
Ai 19-5686-70 Ai 19-5687-70
70x50mm



S/S Alu
Ai 19-5686-80 Ai 19-5687-80
80x60mm



S/S Alu
Ai 19-5686-90 Ai 19-5687-90
80x90mm





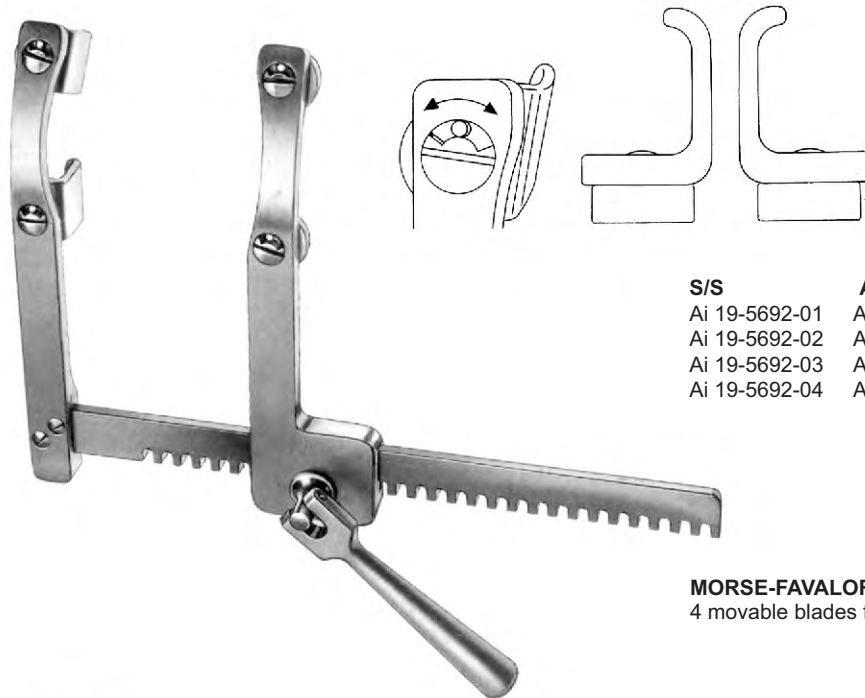
BURFORD
for children
with 2 pairs of blades

S/S	ALU	a	b	c
Ai 19-5688-01	Ai 19-5689-01	30mm	42mm	130mm
Ai 19-5688-02	Ai 19-5689-02	41mm	42mm	135mm
		34mm	42mm	135mm
		48mm	42mm	



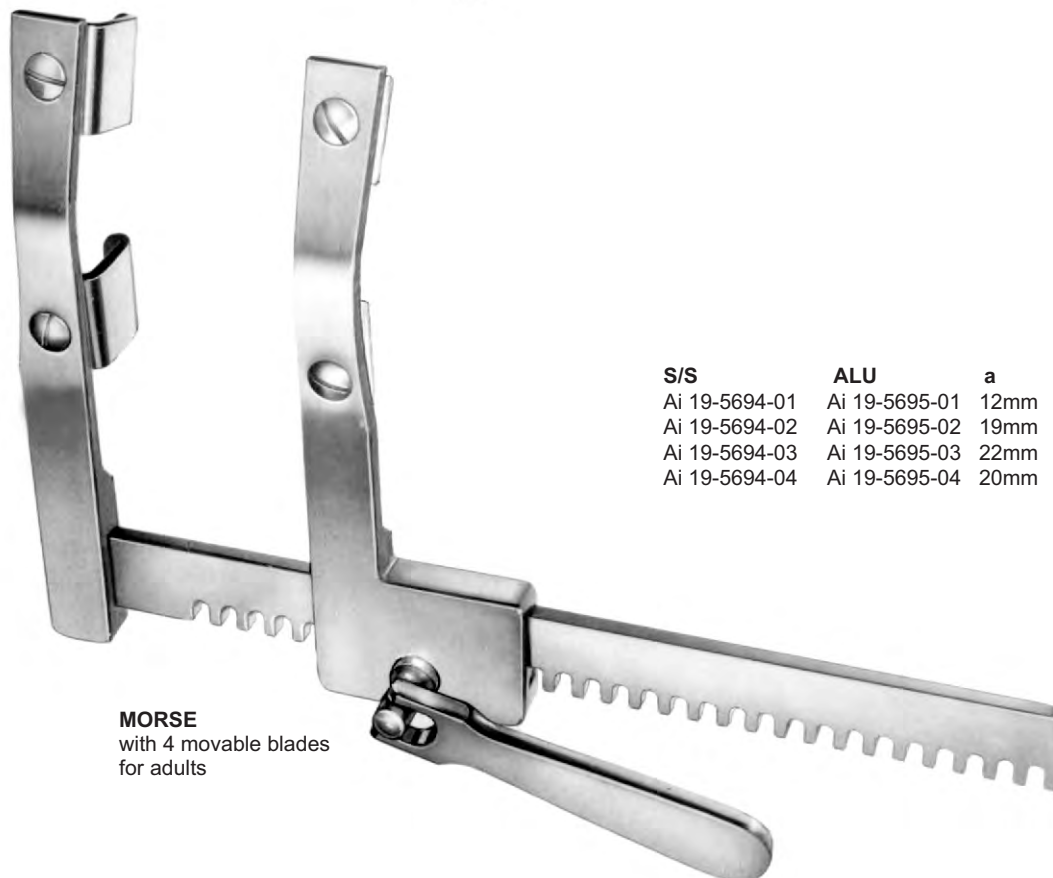
BURFORD
for adults
with 2 pairs of blades

S/S	ALU	a	b	c
Ai 19-5690-01	Ai 19-5691-01	47mm	62mm	200mm
		65mm	62mm	
Ai 19-5690-02	Ai 19-5691-02	47mm	62mm	260mm
		65mm	62mm	
Ai 19-5690-03	Ai 19-5691-03	47mm	62mm	300mm
		65mm	62mm	



S/S	ALU	a	b	c
Ai 19-5692-01	Ai 19-5693-01	12mm	20mm	155mm
Ai 19-5692-02	Ai 19-5693-02	20mm	20mm	155mm
Ai 19-5692-03	Ai 19-5693-03	40mm	20mm	155mm
Ai 19-5692-04	Ai 19-5693-04	17mm	22mm	160mm

MORSE-FAVALORO
 4 movable blades for children



MORSE
 with 4 movable blades
 for adults

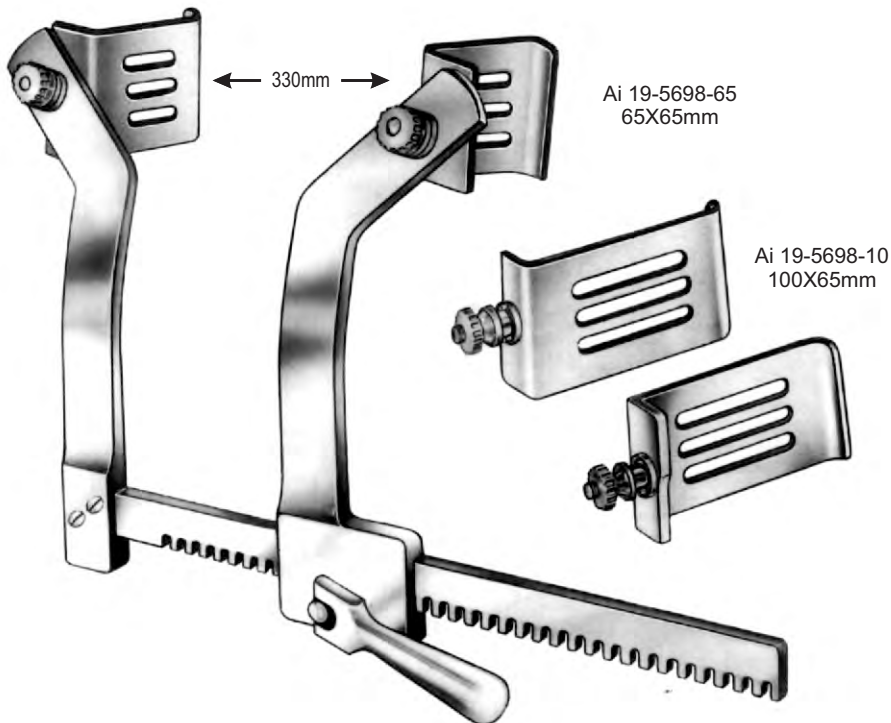
S/S	ALU	a	b	c
Ai 19-5694-01	Ai 19-5695-01	12mm	20mm	200mm
Ai 19-5694-02	Ai 19-5695-02	19mm	19mm	200mm
Ai 19-5694-03	Ai 19-5695-03	22mm	27mm	200mm
Ai 19-5694-04	Ai 19-5695-04	20mm	28mm	210mm





MORSE STERNAL

S/S	ALU	a	b	c
Ai 19-5696-01	Ai 19-5697-01	30mm	35mm	200mm

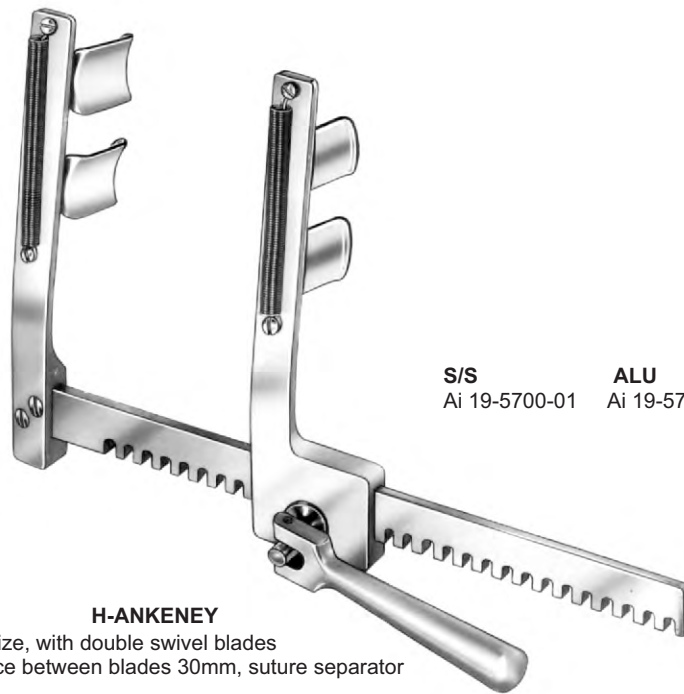


Ai 19-5698-65
65X65mm

Ai 19-5698-10
100X65mm

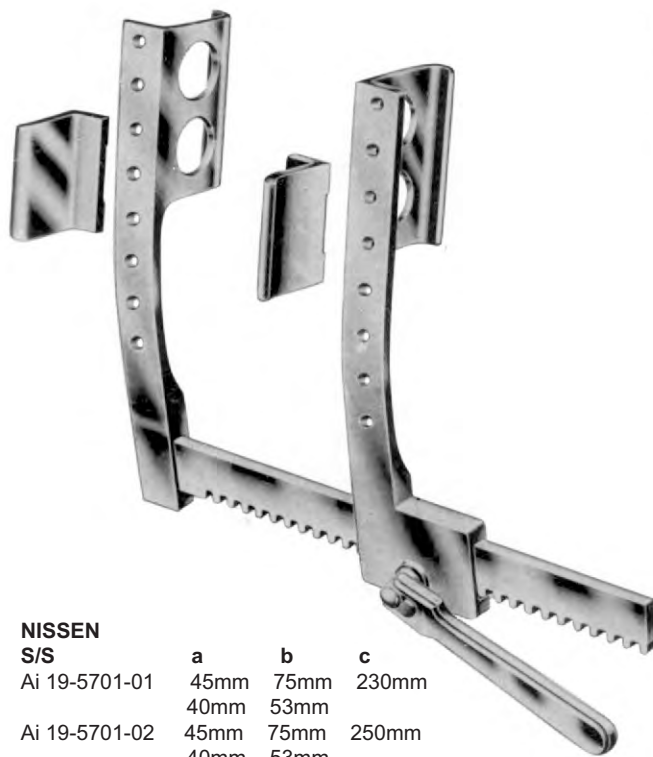
BRAASTAD

S/S	ALU
Ai 19-5698-01	Ai 19-5699-.01
with 2 pairs of blades	
Ai 19-5698-65	Ai 19-5699-65
Ai 19-5698-10	Ai 19-5699-10

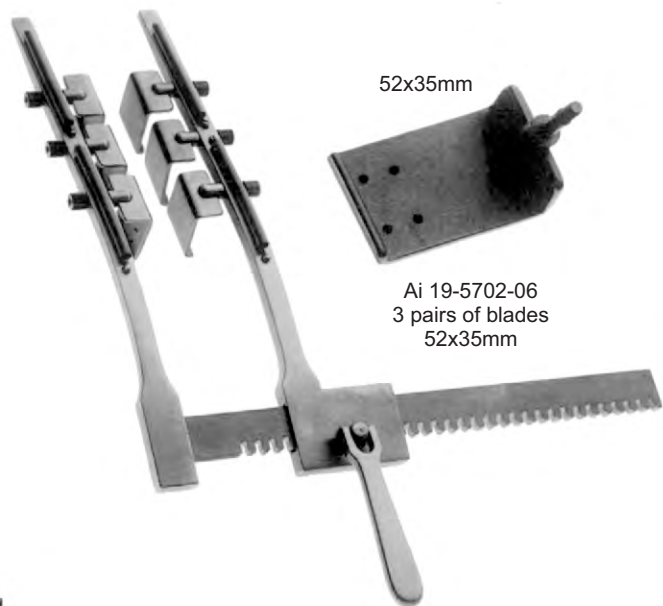


S/S	ALU	a	b	c
Ai 19-5700-01	Ai 19-5700-11	20mm	20mm	160mm

H-ANKENEY
 child size, with double swivel blades
 distance between blades 30mm, suture separator



NISSEN	a	b	c
S/S Ai 19-5701-01	45mm	75mm	230mm
	40mm	53mm	
Ai 19-5701-02	45mm	75mm	250mm
	40mm	53mm	



ANKENEY	a	b	c
S/S Ai 19-5702-01	52mm	35mm	178mm

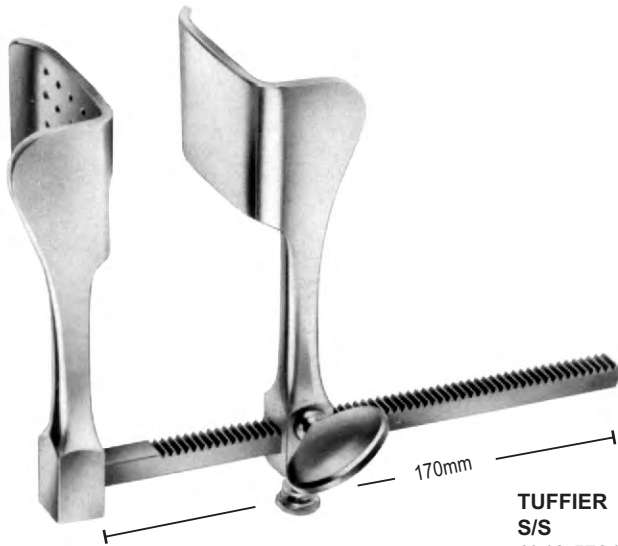
52x35mm

Ai 19-5702-06
 3 pairs of blades
 52x35mm





TUFFIER
S/S
 Ai 19-5703-14 **a** **b** **c**
 32mm 19mm 110mm



TUFFIER
S/S
 Ai 19-5704-17 **a** **b** **c**
 43mm 53mm 130mm

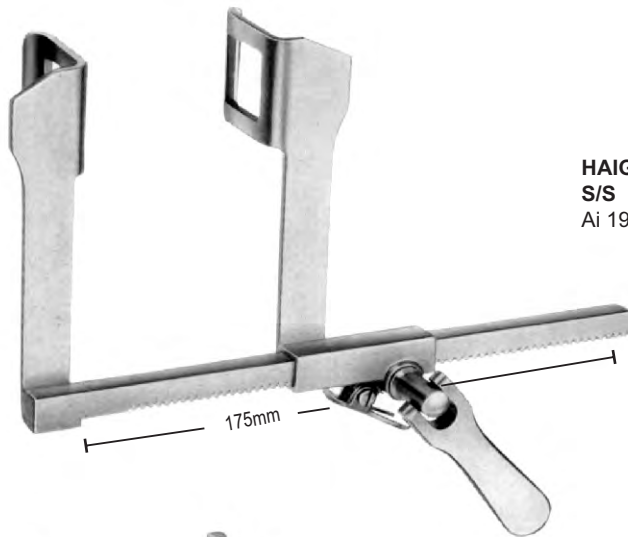


TUFFIER
S/S
 Ai 19-5705-16 **a** **b** **c**
 50mm 45mm 165mm





HAIGHT
S/S
 Ai 19-5706-14 **a** **b** **c**
 30mm 30mm 90mm

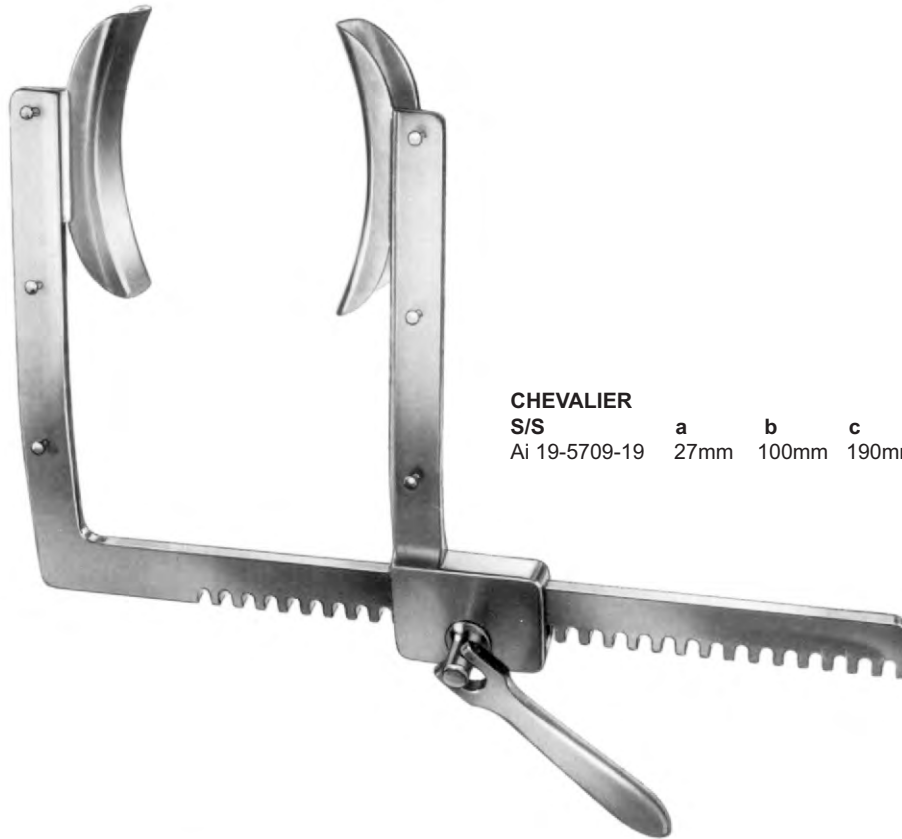


HAIGHT
S/S
 Ai 19-5707-15 **a** **b** **c**
 30mm 30mm 115mm

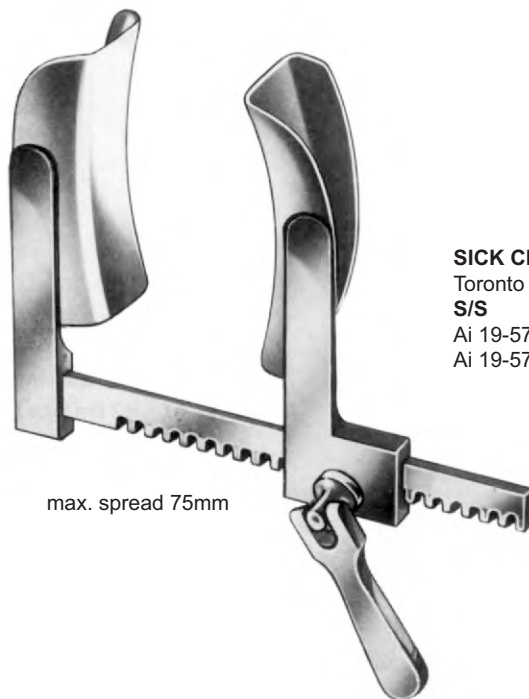


HERTZLER
S/S
 Ai 19-5708-15 **a** **b** **c**
 20mm 25mm 105mm





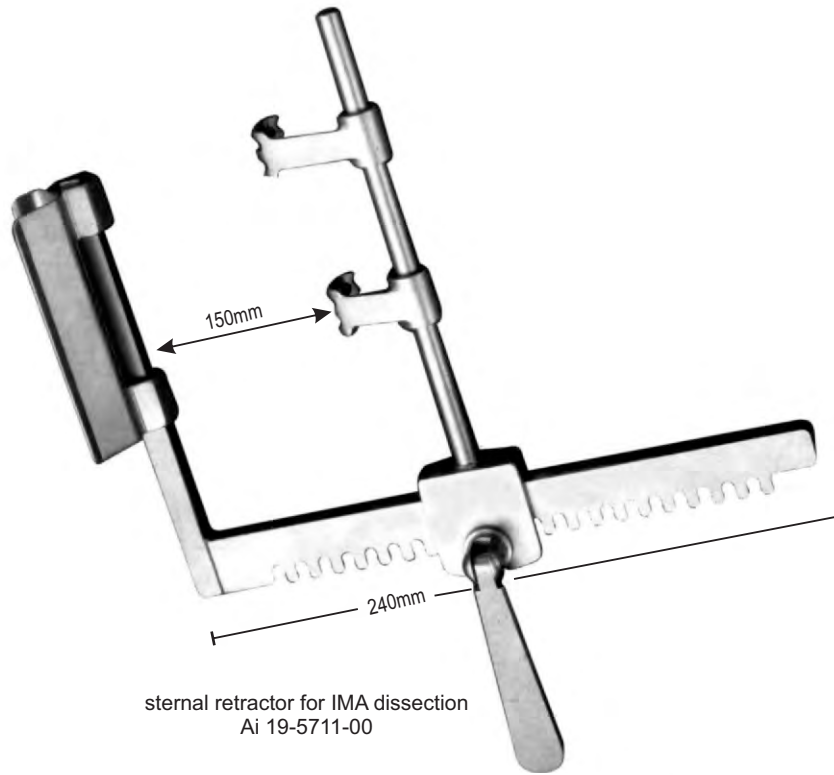
CHEVALIER
 S/S
 Ai 19-5709-19 a b c
 27mm 100mm 190mm



SICK CHILDREN HOSPITAL
 Toronto
 S/S
 Ai 19-5710-01 (child) a b c
 Ai 19-5710-02 (adult) 20mm 60mm 75mm

max. spread 75mm



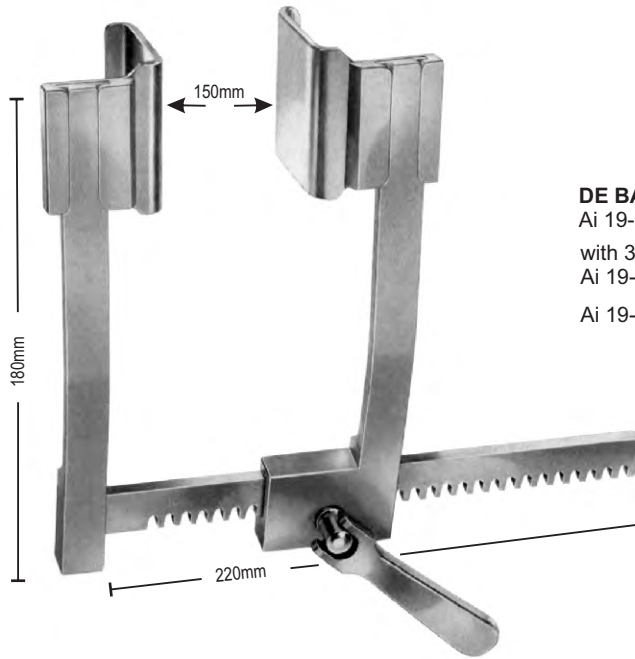


sternal retractor for IMA dissection
Ai 19-5711-00



Carpenter's thoracic retractor
(adult)
Ai 19-5712-00 complete





DE BAKY
 Ai 19-5713-00
 with 3 pairs of blades
 Ai 19-5713-01
 Ai 19-5713-22 spreader only



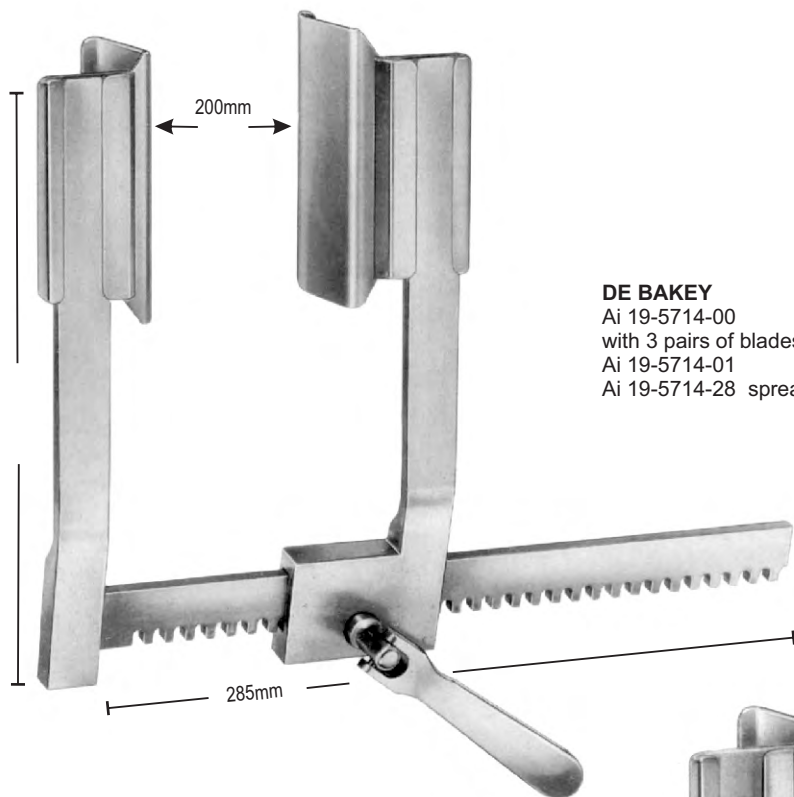
Blades
 Ai 19-5713-01
 30 x 30 mm



Blades
 Ai 19-5713-02
 40 x 40 mm

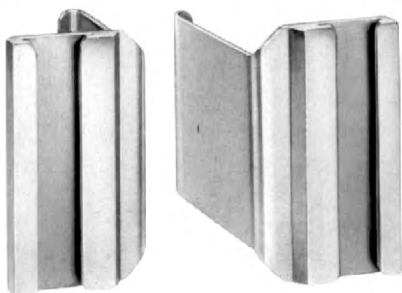


Blades
 Ai 19-5713-03
 50 x 50 mm



DE BAKEY
 Ai 19-5714-00
 with 3 pairs of blades
 Ai 19-5714-01
 Ai 19-5714-28 spreader only

blades
 Ai 19-5714-01
 60 x 60 mm



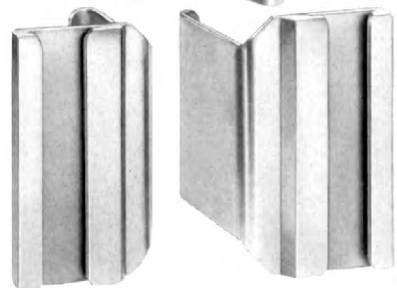
blades
 Ai 19-5714-02
 50 x 80 mm



blades
 Ai 19-5714-03
 40 x 100 mm

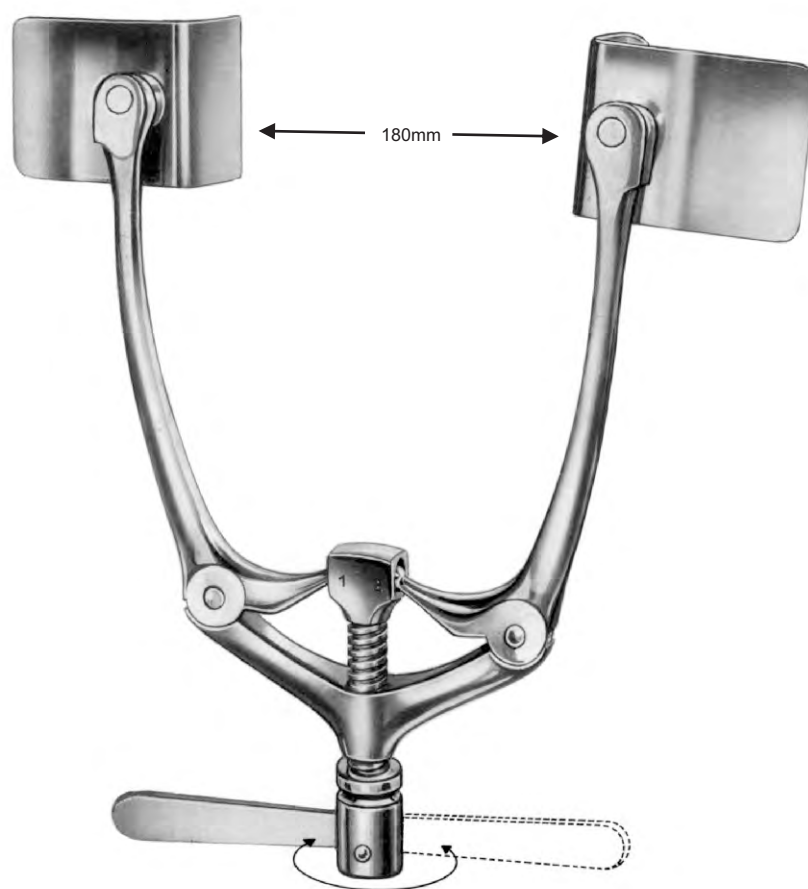


blades
 Ai 19-5714-04
 80 x 60 mm

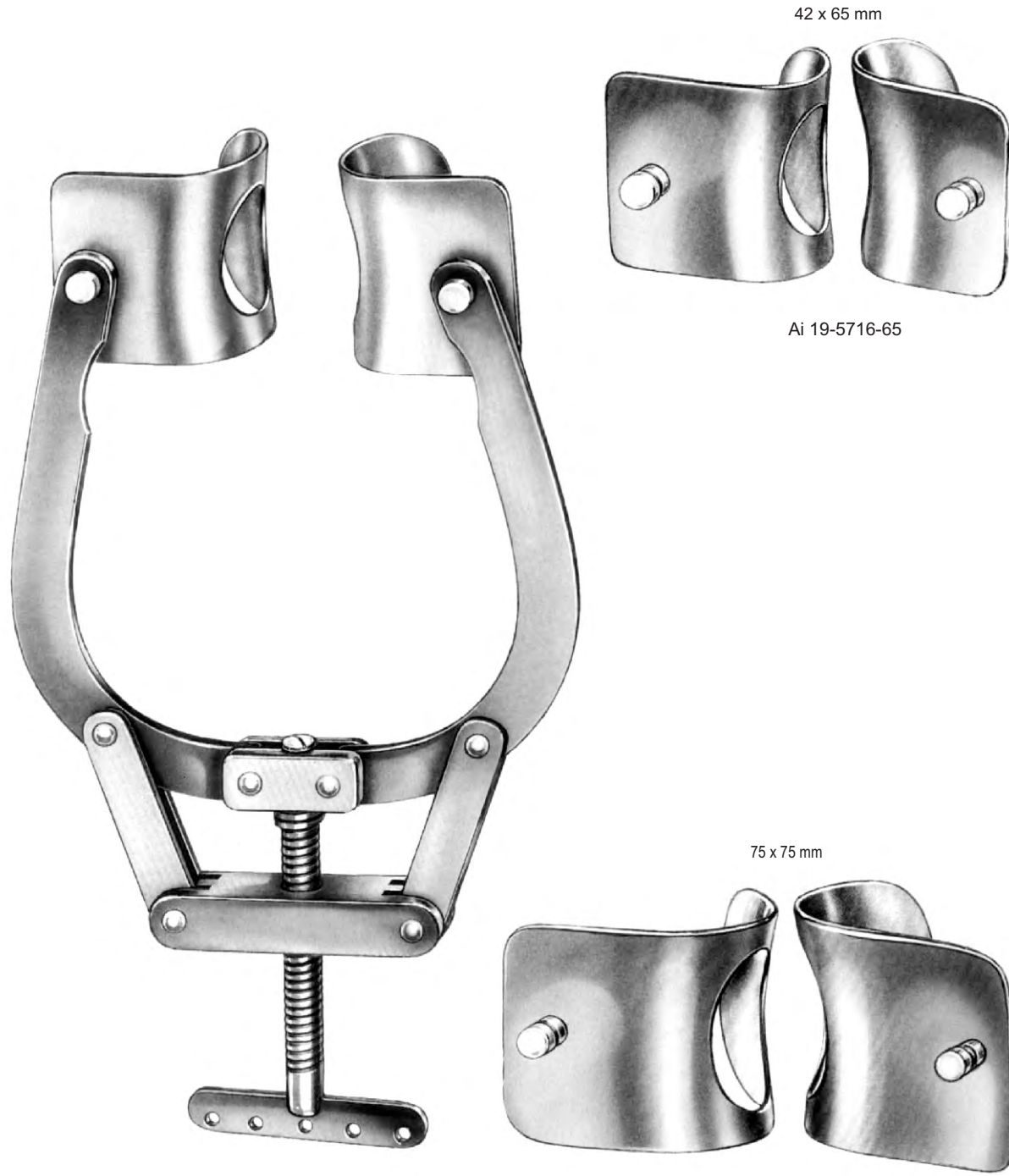


blades
 Ai 19-5714-05
 50 x 66 mm





QUERVAIN
Ai 19-5715-00
35 X 50 X 180 mm



Ai 19-5716-00 complete consisting of:
 Ai 19-5716-01 retractor only
 Ai 19-5716-65 1 pair blades 42x65mm
 Ai 19-5716-75 1 pair blades 75x75mm

Ai 19-5716-75



Lemmon
 Ai 19-5744-18 18 cm/7"
 Ai 19-5744-14 14 cm/5½"



CRAFOORD
 Ai 19-5744-28
 28.0cm



Sellors
Ai 19-5745-19
19 cm/7½"



Bailey-Baby
Ai 19-5746-14
14 cm/5½"





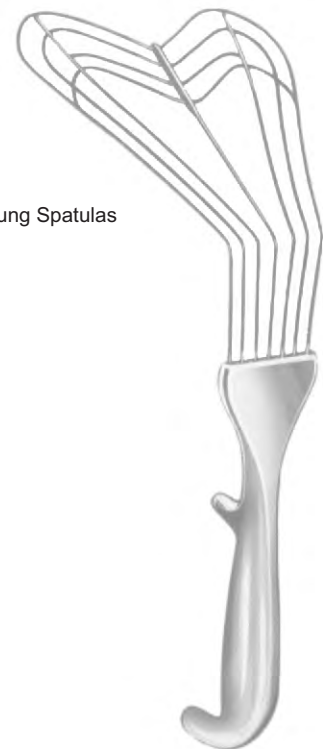
Bailey
 Ai 19-5747-16 16 cm/6¼"
 Ai 19-5747-20 20 cm/8"



Bailey-Gibbon
 Ai 19-5748-16 16 cm/6¼"
 Ai 19-5748-20 20 cm/8"



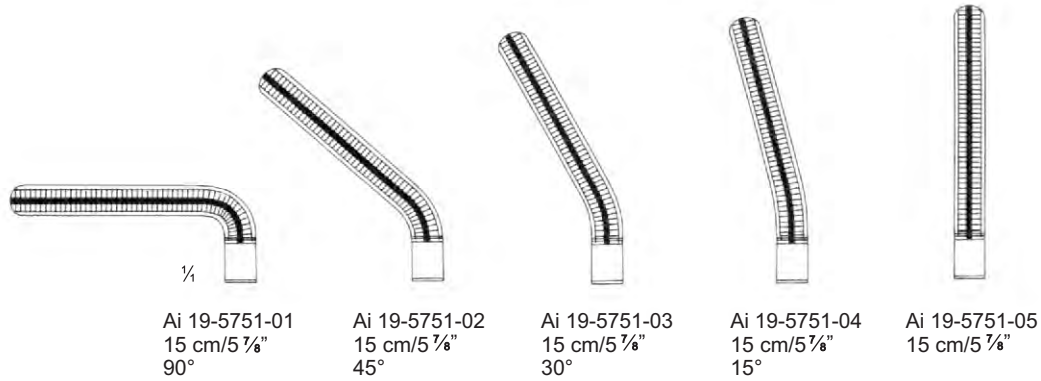
Allison
 Ai 19-5749-25 25.5 cm/10"
 Ai 19-5749-30 30.0 cm/12"
 Ai 19-5749-32 32.0 cm/13"



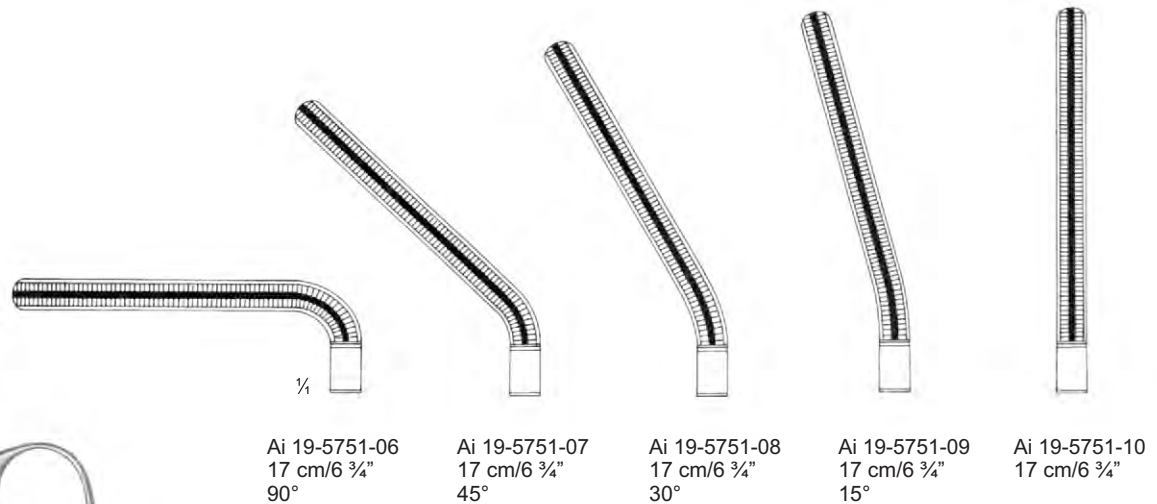
Lung Spatulas

Ai 19-5750-30
 30 cm/12"

ATRAUMA



DARDIK





1/2

DALE
 Ai 19-5752-18
 18 cm/7 1/8"



1/4

ATRAUMA



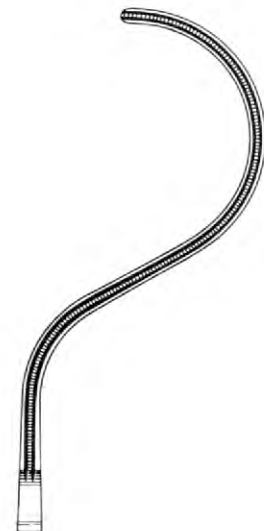
DALE



Ai 19-5753-17
 17.5 cm/6 7/8"

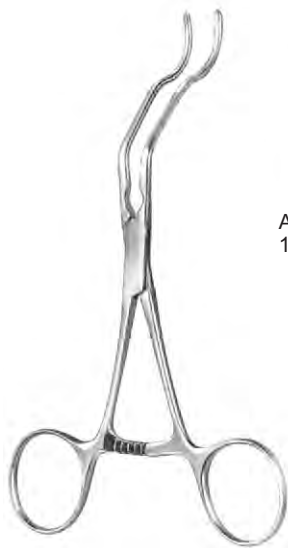


Ai 19-5753-18
 18 cm/7 1/8"



Ai 19-5753-19
 19 cm/7 1/2"

ATRAUMA



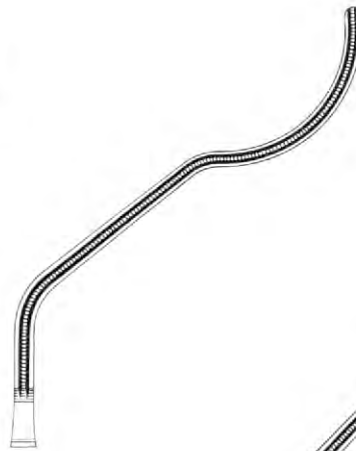
GREGORY



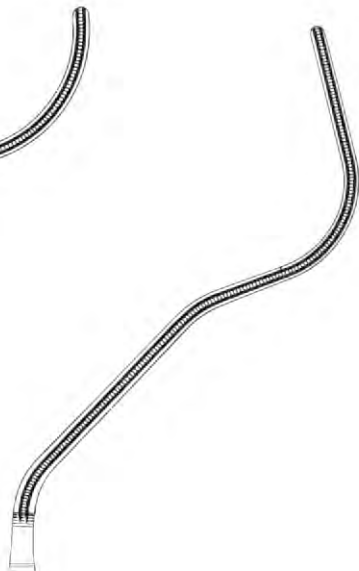
Ai 19-5754-14
14 cm/5 1/2"



Ai 19-5754-16
16 cm/6 1/4"



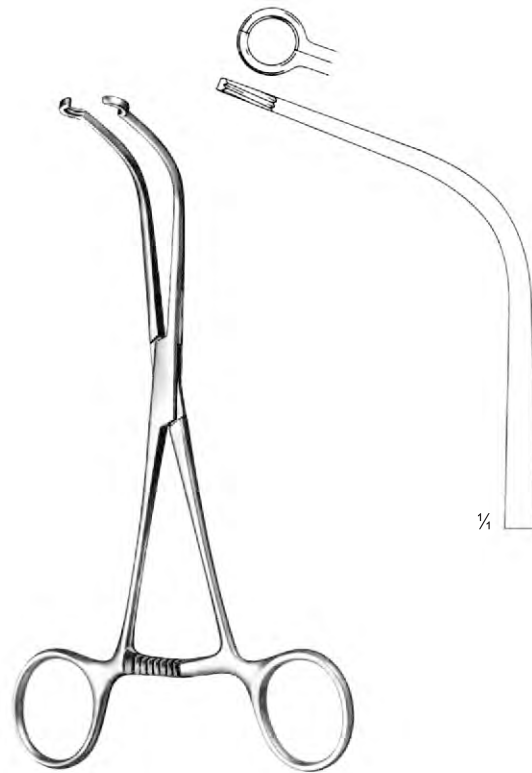
Ai 19-5754-18
18 cm/7 1/8"



ATRAUMA

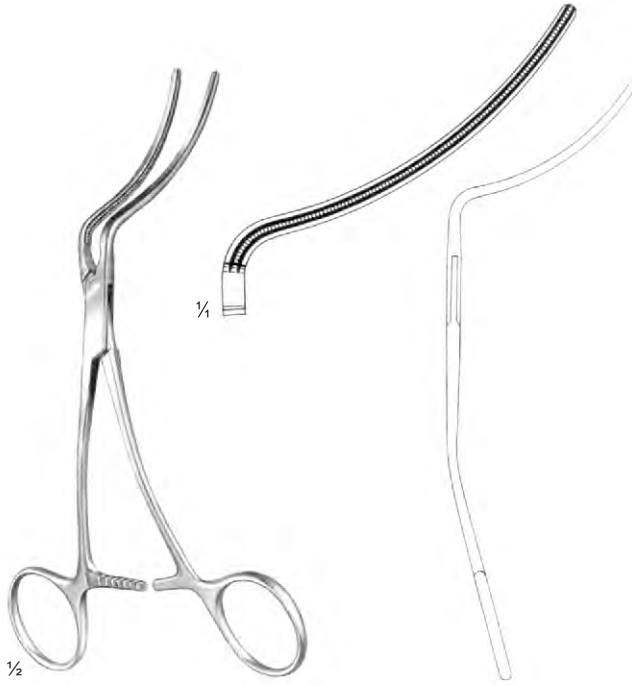


JAVID
 Ai 19-5755-18
 18 cm/6 7/8"

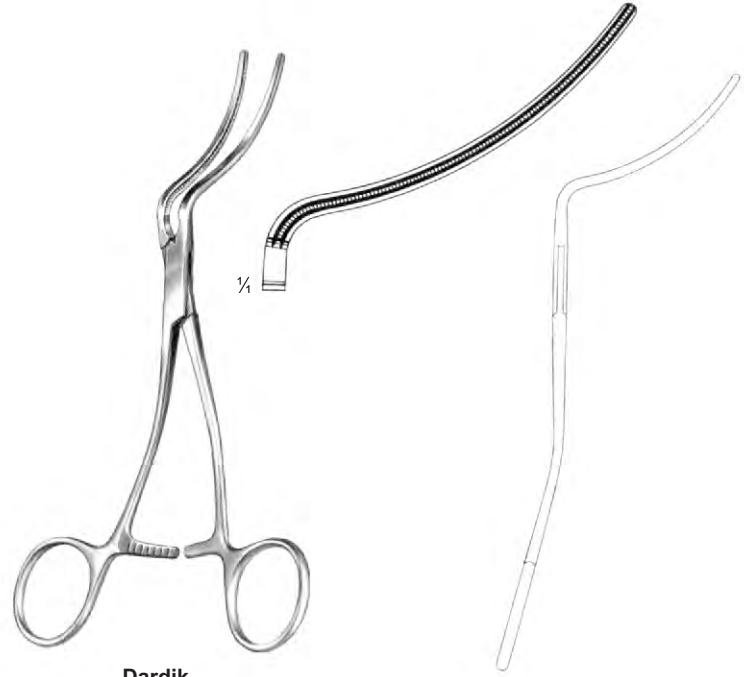


JAVID
 Ai 19-5756-19
 19 cm/7 1/4"

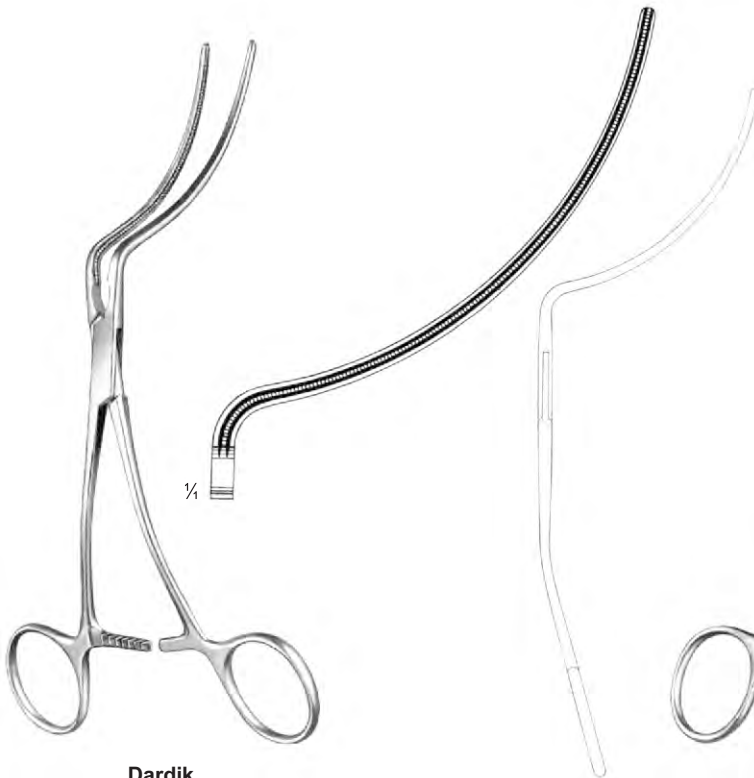
ATRAUMA



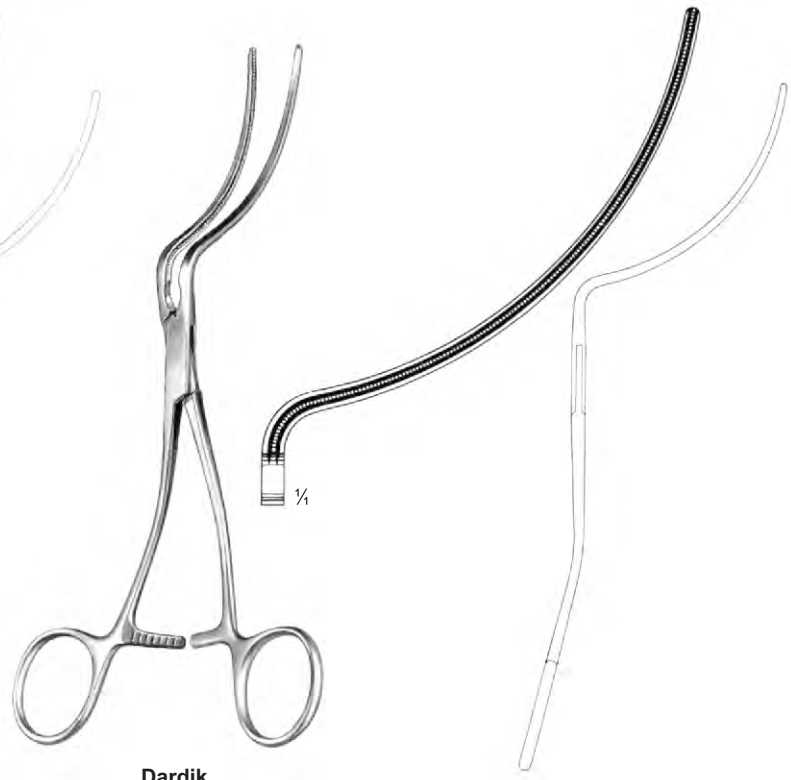
Dardik
 Ai 19-5757-16
 16 cm/6 1/4"



Dardik
 Ai 19-5758-17
 17 cm/6 3/4"



Dardik
 Ai 19-5759-18
 18 cm/7 1/8"



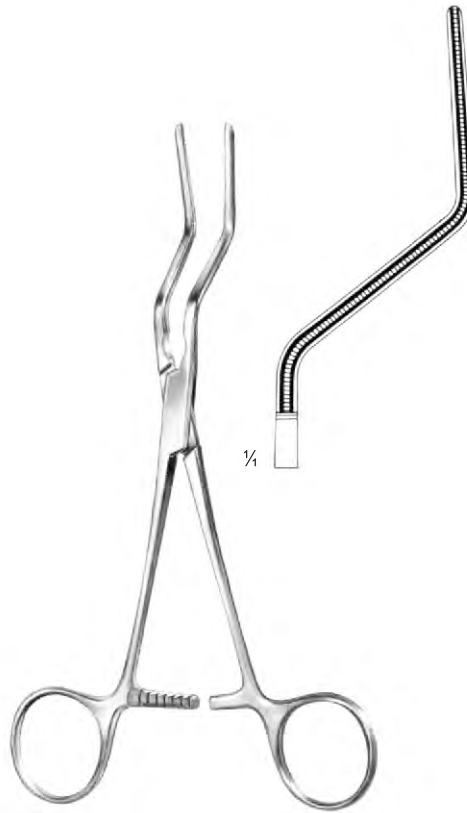
Dardik
 Ai 19-5760-19
 19.5 cm/7 3/4"



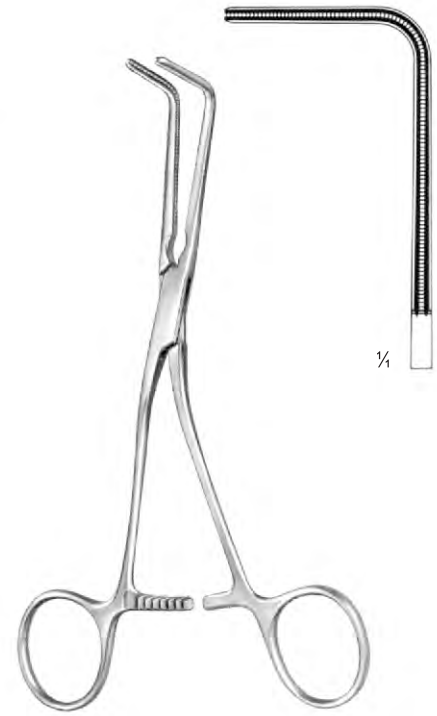
ATRAUMA



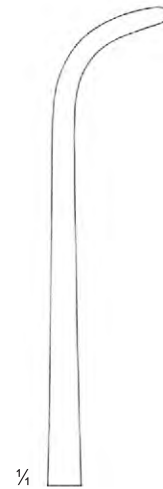
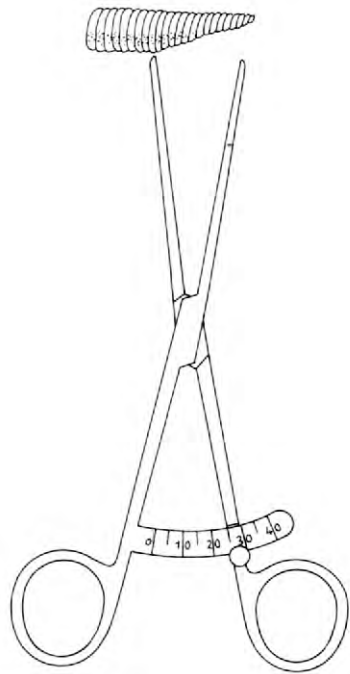
HUSFELDT
 Ai 19-5761-17
 17.5 cm/6 7/8"



HUSFELDT
 Ai 19-5762-18
 18 cm/7 1/8"



HUSFELDT
 Ai 19-5763-17
 17 cm/6 3/4"

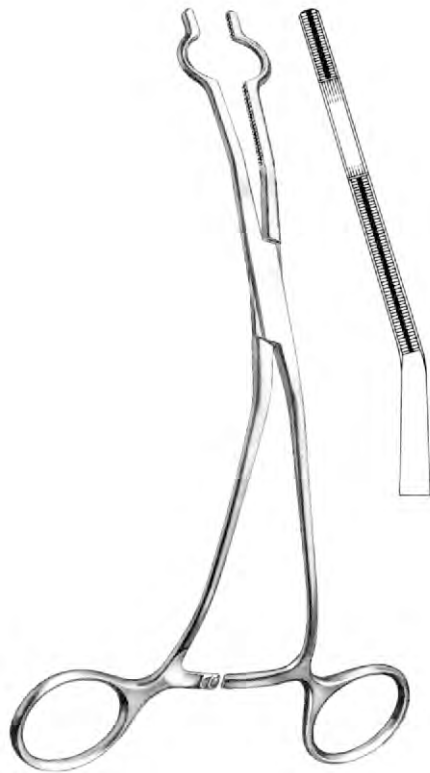


Ai 19-5764-17
17 cm/6 $\frac{3}{4}$ "
Vascular Measuring Device





ATRAUMA



COOLEY



Ai 19-5765-01
 17 cm/6 3/4"
 20 Charr.



Ai 19-5765-02
 17 cm/6 3/4"
 24 Charr.



Ai 19-5765-03
 17 cm/6 3/4"
 26 Charr.



Ai 19-5765-04
 20 cm/7 7/8"
 28 Charr.



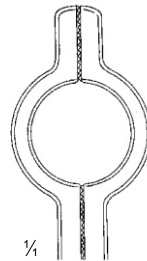
Ai 19-5765-05
 20 cm/7 7/8"
 30 Charr.



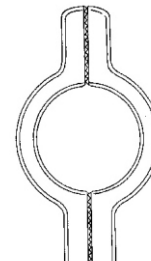
Ai 19-5765-06
 20 cm/7 7/8"
 32 Charr.



Ai 19-5765-07
 20 cm/7 7/8"
 36 Charr.

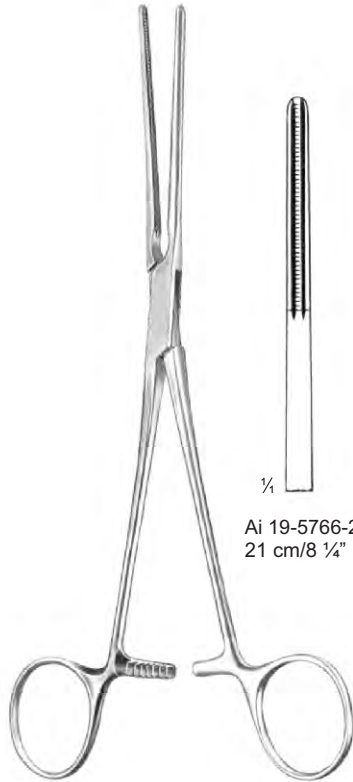


Ai 19-5765-08
 20 cm/7 7/8"
 38 Charr.



Ai 19-5765-09
 20 cm/7 7/8"
 40 Charr.

ATRAUMA



Ai 19-5766-21
 21 cm/8 1/4"

POTTS

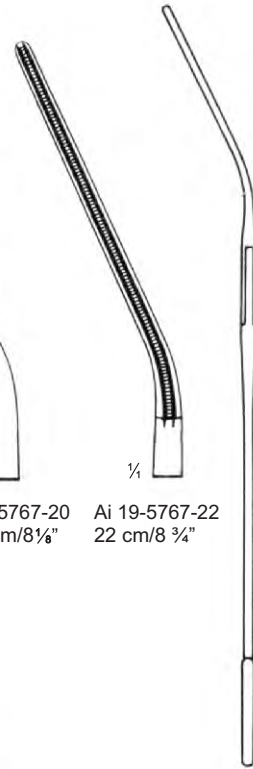


Ai 19-5766-22
 22.5 cm/8 3/4"

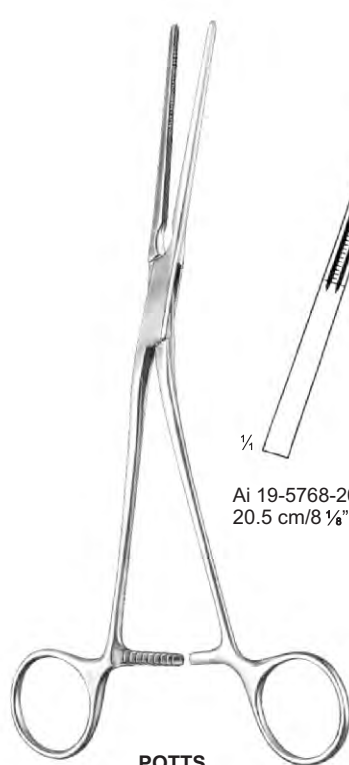


Ai 19-5767-20
 20.5 cm/8 1/8"

POTTS

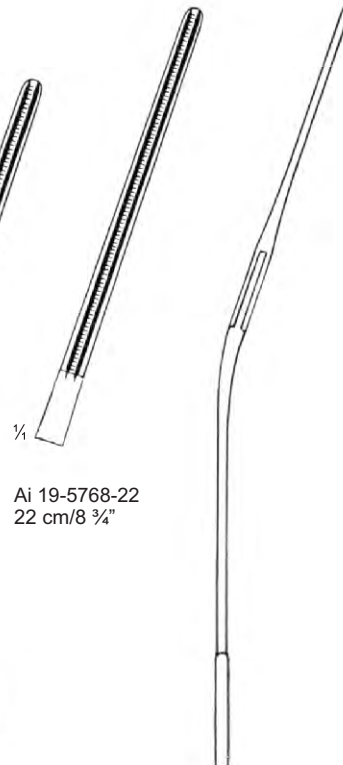


Ai 19-5767-22
 22 cm/8 3/4"



Ai 19-5768-20
 20.5 cm/8 1/8"

POTTS



Ai 19-5768-22
 22 cm/8 3/4"



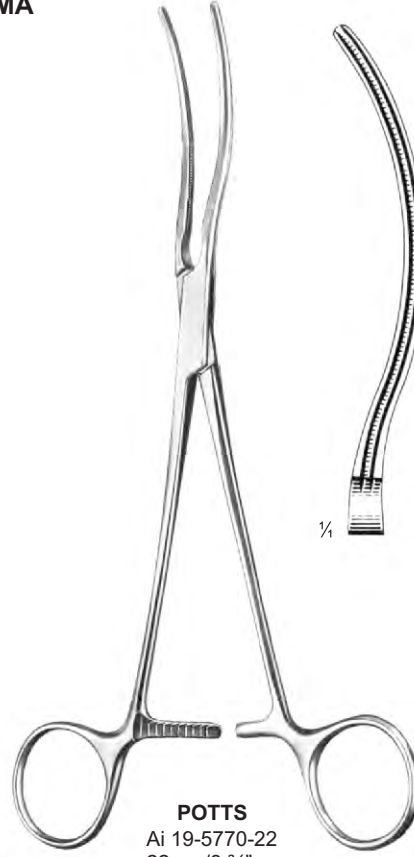
ATRAUMA



POTTS-GLOVER
 Ai 19-5769-21
 21.5 cm/8 1/2"



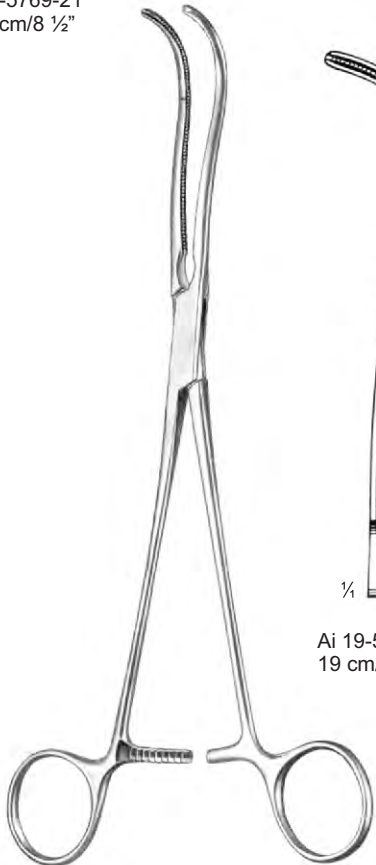
1/4



POTTS
 Ai 19-5770-22
 22 cm/8 3/4"



1/4



DEBAKEY
 Dissecting and Ligature Forceps



1/4

Ai 19-5771-19
 19 cm/7 1/2"



1/4

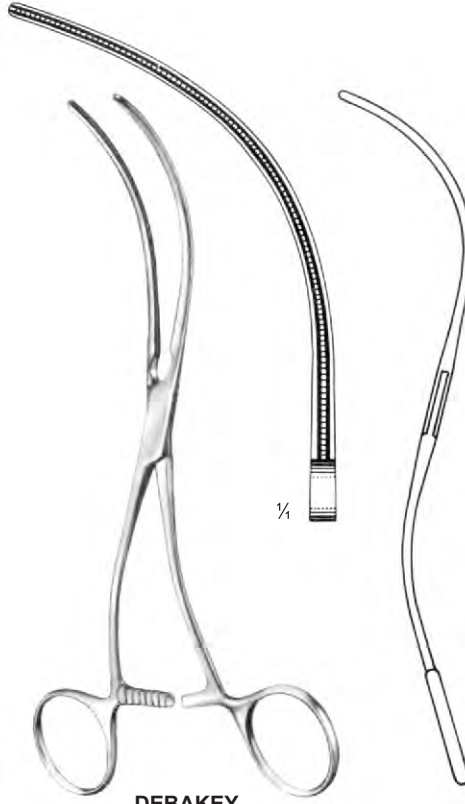
Ai 19-5771-24
 24 cm/9 1/2"



ATRAUMA



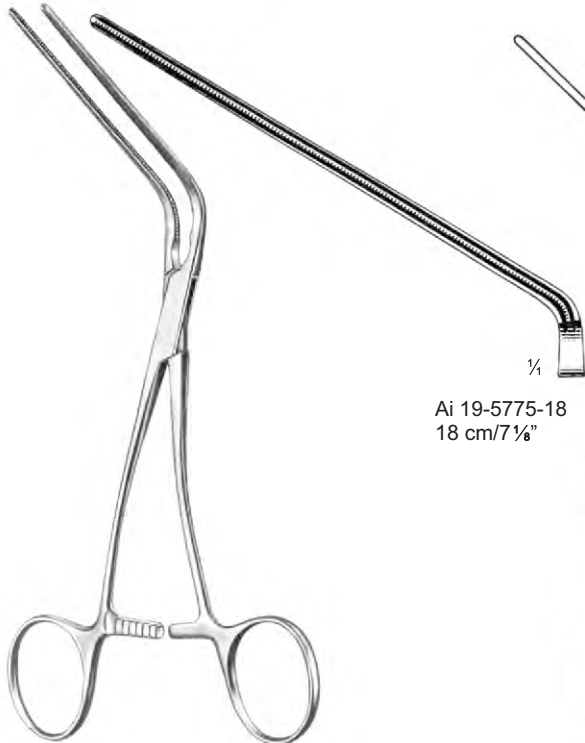
DEBAKEY
 Ai 19-5772-16
 16 cm/6 1/4"



DEBAKEY
 Ai 19-5773-19
 19 cm/7 1/2"

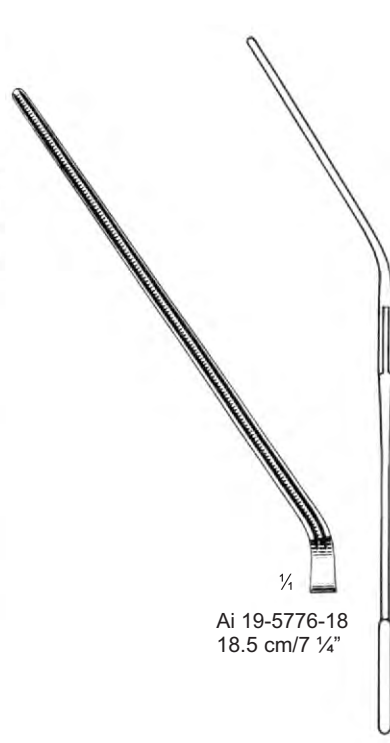


DEBAKEY
 Ai 19-5774-20
 20 cm/8"

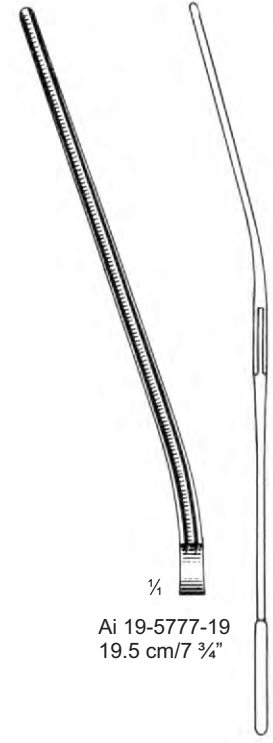


LELAND-JONES

Ai 19-5775-18
 18 cm/7 1/8"



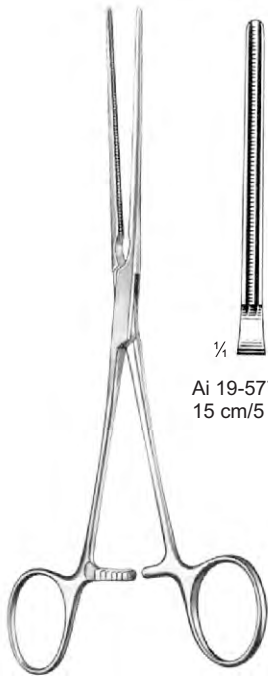
Ai 19-5776-18
 18.5 cm/7 1/4"



Ai 19-5777-19
 19.5 cm/7 3/4"



ATRAUMA



¼
 Ai 19-5778-15
 15 cm/5 7/8"

BAINBRIDGE



¼
 Ai 19-5778-18
 18.5 cm/7 1/4"



¼
 Ai 19-5779-15
 15 cm/5 7/8"

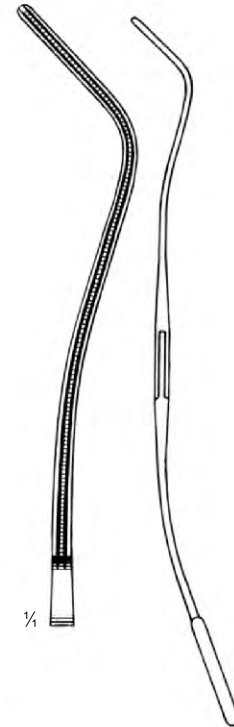
BAINBRIDGE



¼
 Ai 19-5779-18
 18.5 cm/7 1/4"



DEBAKEY
 Ai 19-5780-20
 20 cm/7 7/8"



ATRAUMA



DEBAKEY

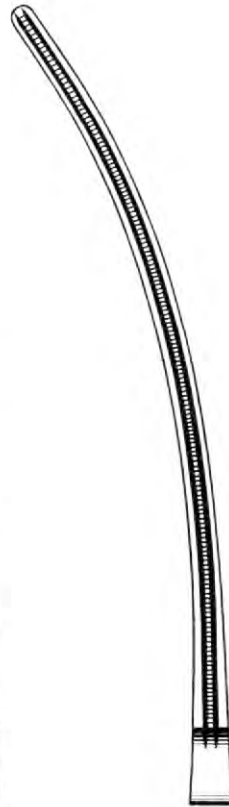


¼

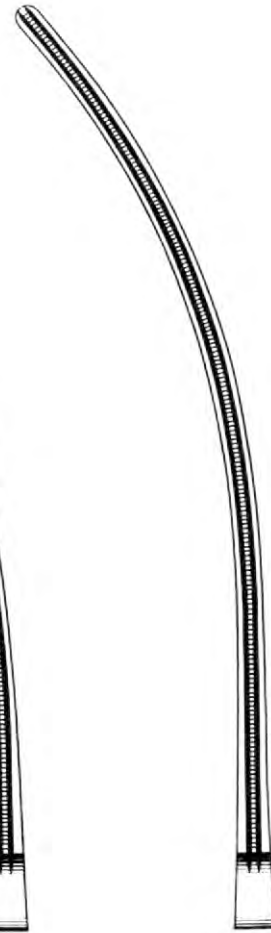
Ai 19-5781-26
26 cm/10 ¼"



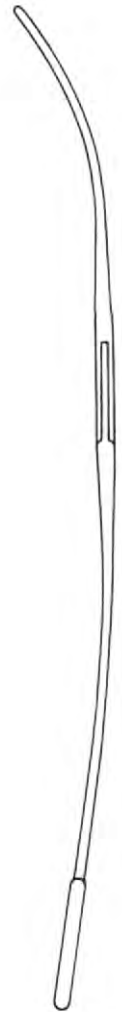
Ai 19-5782-27
27 cm/10 ½"



Ai 19-5783-31
31 cm/12 ¼"



Ai 19-5784-33
33 cm/13"



ATRAUMA



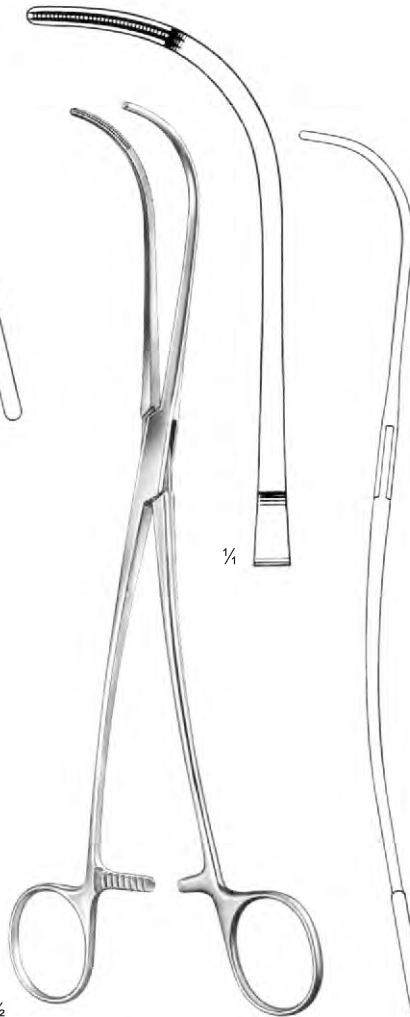
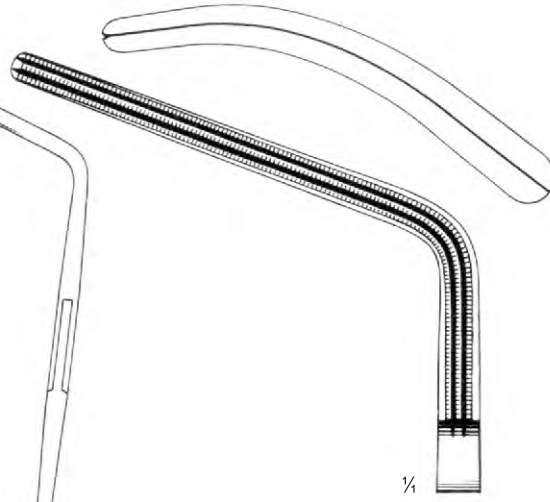
DEBAKEY
 Ai 19-5785-28
 28 cm/11"

DEBAKEY
 Ai 19-5786-30
 30 cm/11 3/4"

ATRAUMA



DEBAKEY
 Ai 19-5787-27
 27 cm/10 1/2"



DEBAKEY
 Ai 19-5788-24
 24.5 cm/9 5/8"



DEBAKEY
 Ai 19-5789-24
 24.5 cm/9 5/8"



ATRAUMA

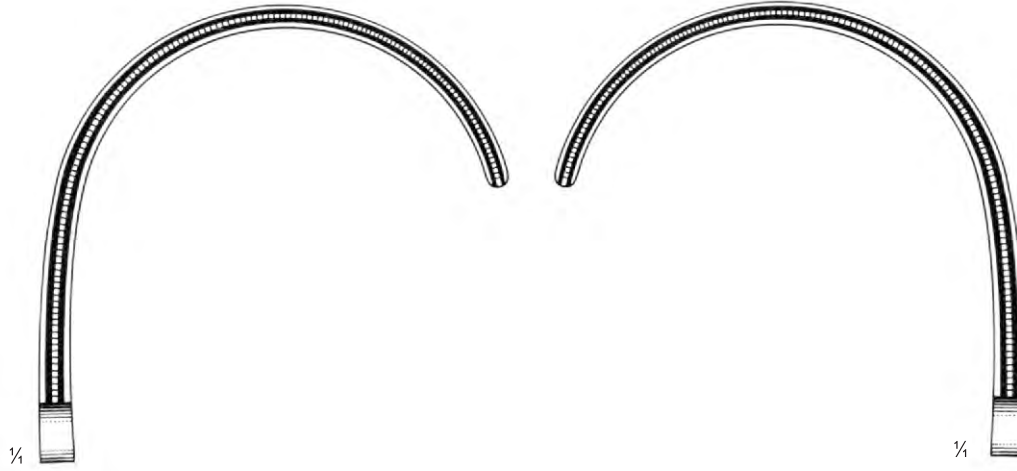


DEBAKEY
 Ai 19-5790-27
 27 cm/10 1/2"



DEBAKEY
 Ai 19-5791-27
 27 cm/10 1/2"

ATRAUMA



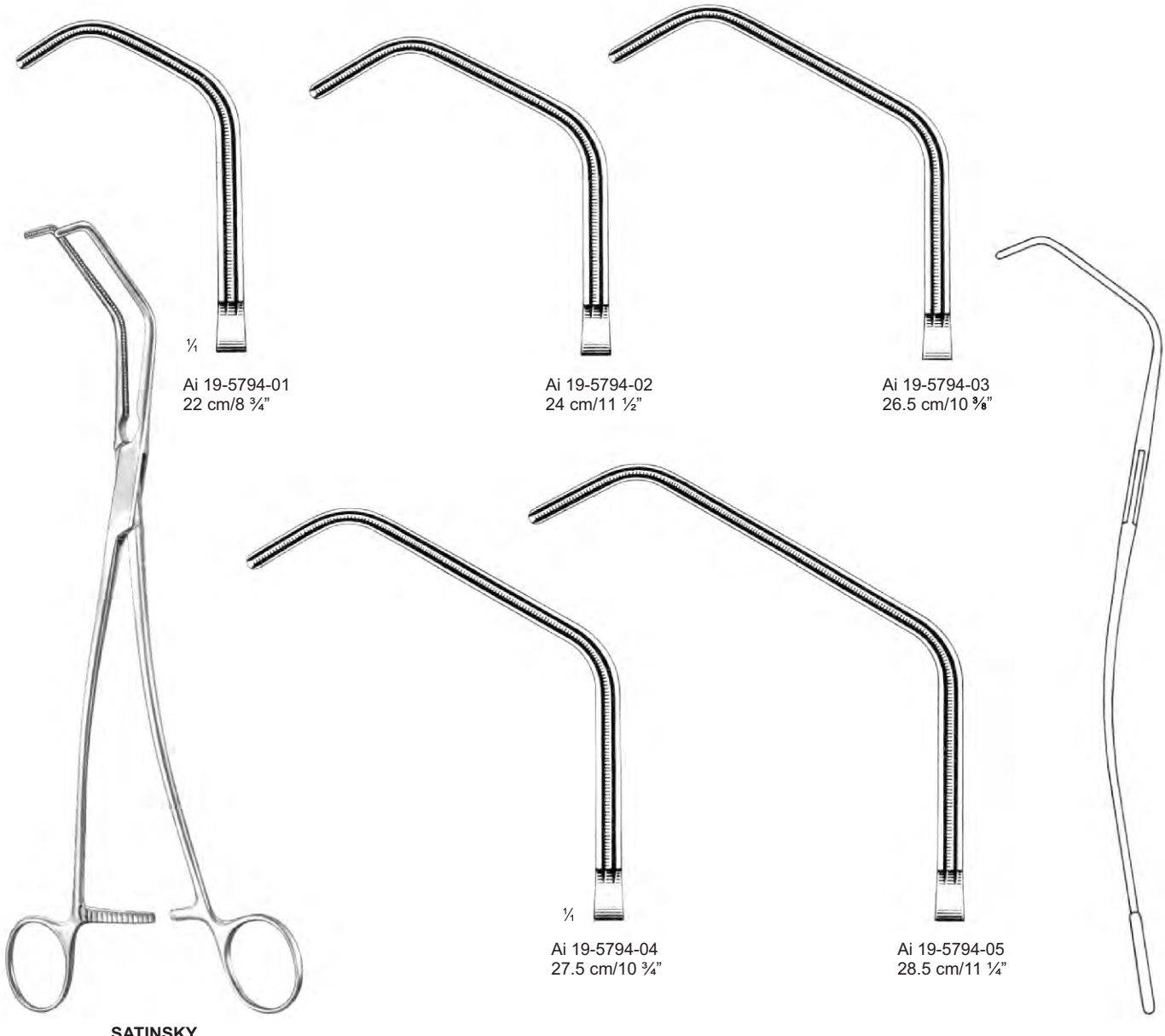
WEBER
Ai 19-5792-24
24 cm/9 1/2"



WEBER
Ai 19-5793-24
24 cm/9 1/2"



ATRAUMA



¼
Ai 19-5794-01
22 cm/8 ¾"

Ai 19-5794-02
24 cm/11 ½"

Ai 19-5794-03
26.5 cm/10 ¼"

¼
Ai 19-5794-04
27.5 cm/10 ¾"

Ai 19-5794-05
28.5 cm/11 ¼"

SATINSKY

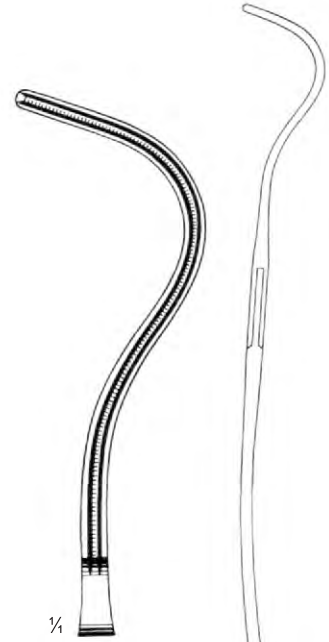
ATRAUMA



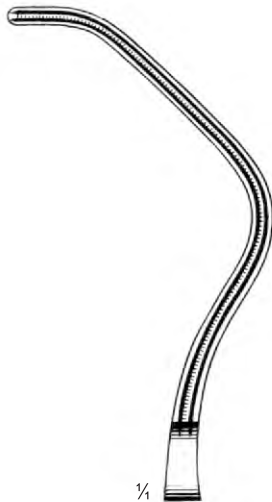
HARKEN



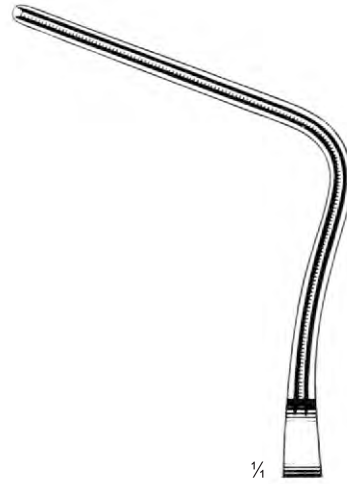
1/4
Ai 19-5795-01
24.5 cm/9 5/8"



1/4
Ai 19-5795-02
24 cm/9 1/2"



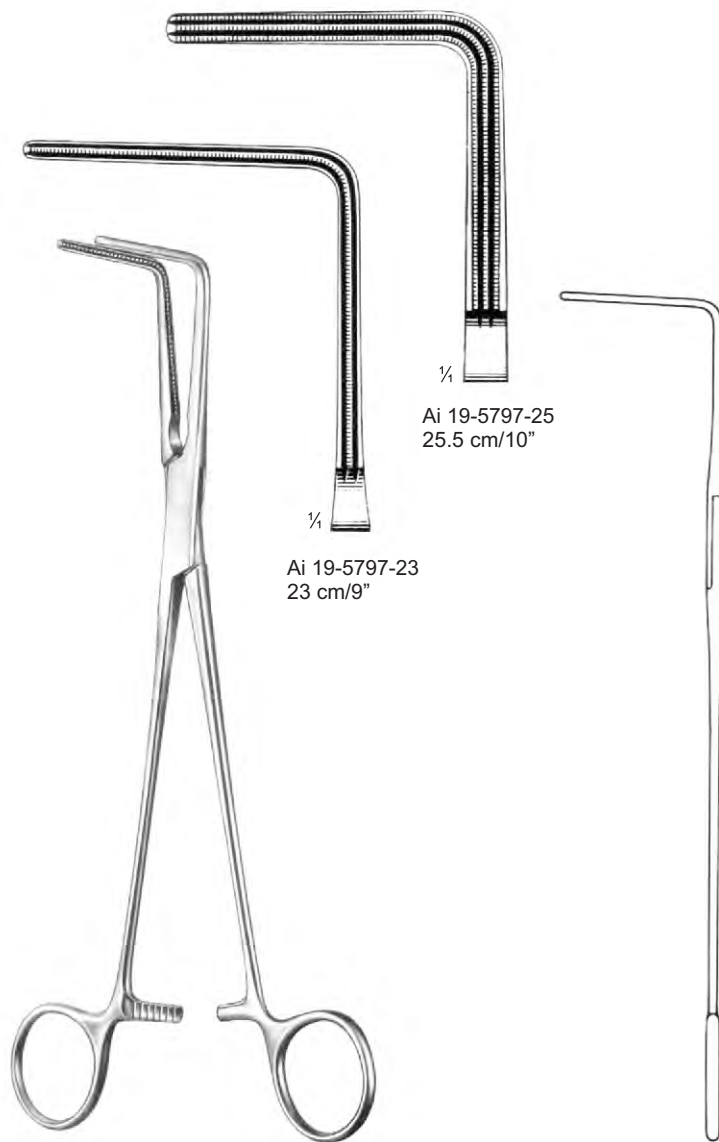
1/4
Ai 19-5795-03
23 cm/9"



1/4
Ai 19-5795-04
23.5 cm/9 1/4"



ATRAUMA



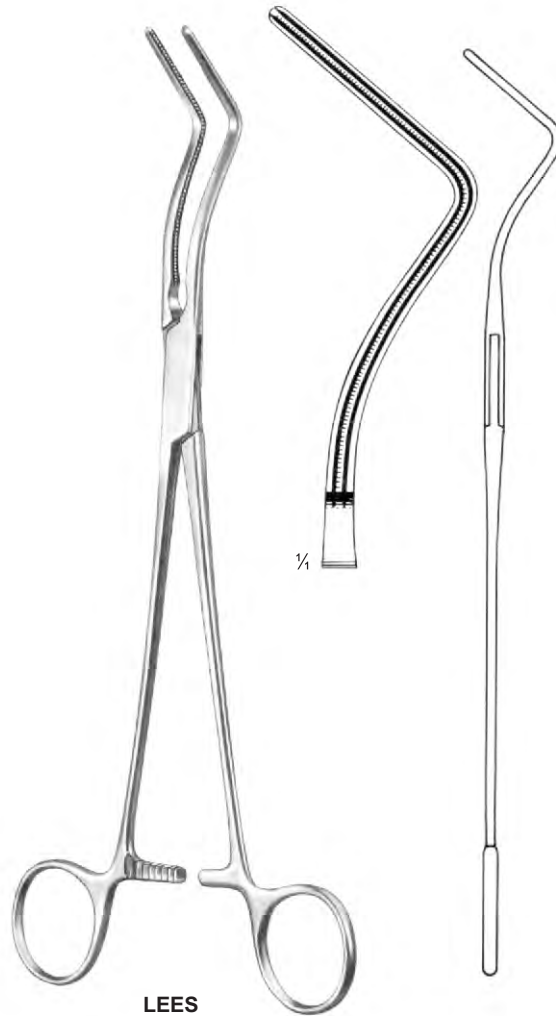
Ai 19-5797-23
23 cm/9"

Ai 19-5797-25
25.5 cm/10"

LEES



ATRAUMA



LEES
Ai 19-5798-25
25 cm/9 7/8"



ATRAUMA

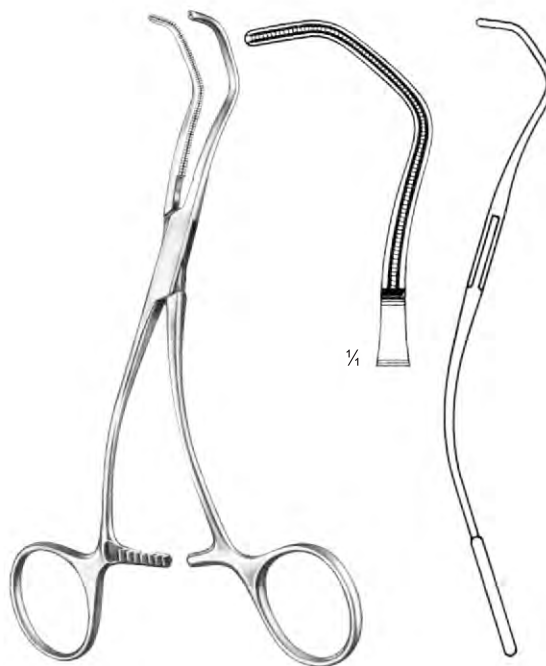


LAMBERT-KAY



Ai 19-5799-01
 22.5 cm/8 3/4"

Ai 19-5799-02
 22.5 cm/8 3/4"



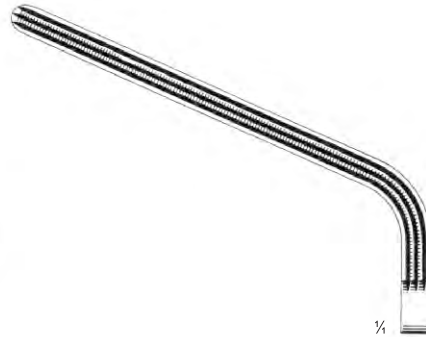
DEBAKEY
 Ai 19-5800-16
 16.5 cm/6 1/2"



ATRAUMA



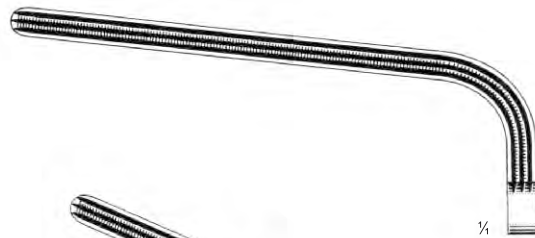
Ai 19-5801-18
18.5 cm/7 1/4"



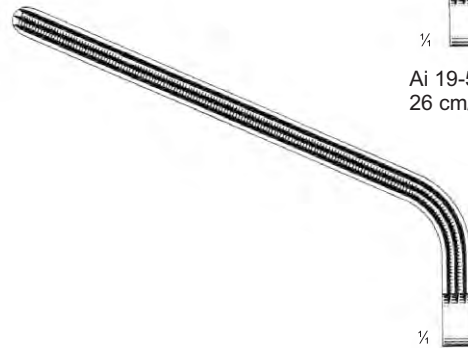
Ai 19-5801-20
20 cm/7 1/4"



MORRIS-DEBAKEY



Ai 19-5801-26
26 cm/10 1/4"



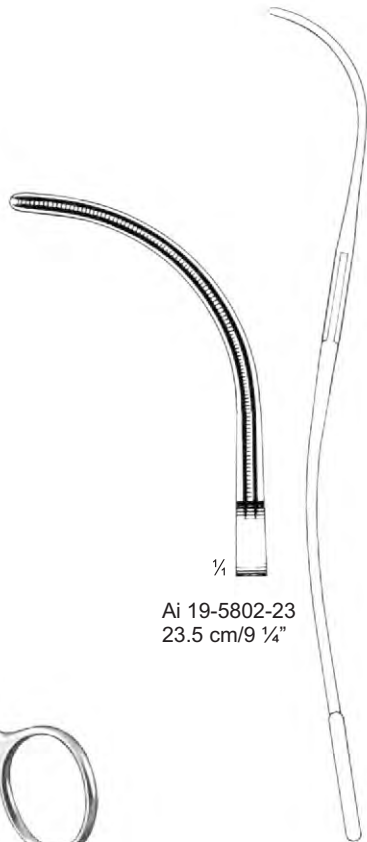
Ai 19-5801-27
27.5 cm/10 3/4"



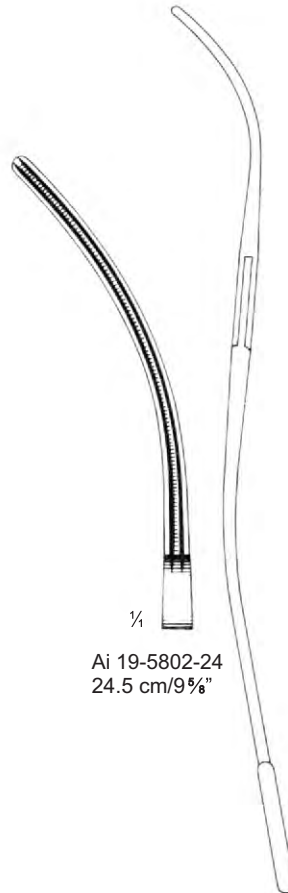
ATRAUMA



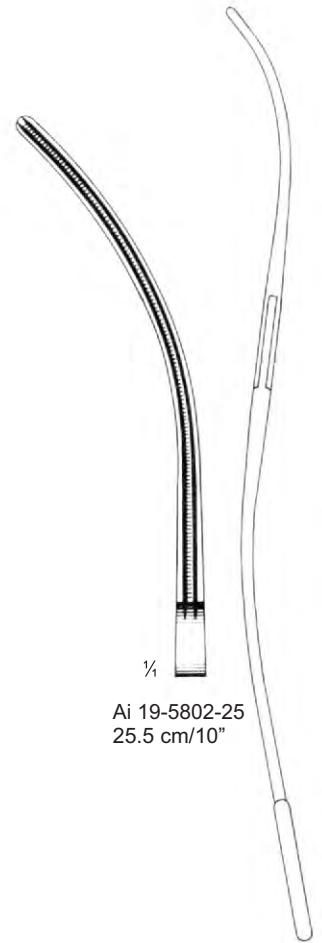
DEBAKEY-BAHNSON



Ai 19-5802-23
23.5 cm/9 1/4"



Ai 19-5802-24
24.5 cm/9 5/8"



Ai 19-5802-25
25.5 cm/10"

ATRAUMA



POTTS



1/4
 Ai 19-5803-21
 21.5 cm/8 1/2"



Ai 19-5803-23
 23.5 cm/9 1/4"



Ai 19-5803-27
 27 cm/10 1/2"



Ai 19-5803-31
 31.5 cm/12 3/8"



POTTS



1/4
 Ai 19-5804-21
 21 cm/8 1/4"



Ai 19-5804-23
 23 cm/9"



Ai 19-5804-26
 26 cm/10 1/4"



Ai 19-5804-31
 31 cm/12 1/4"



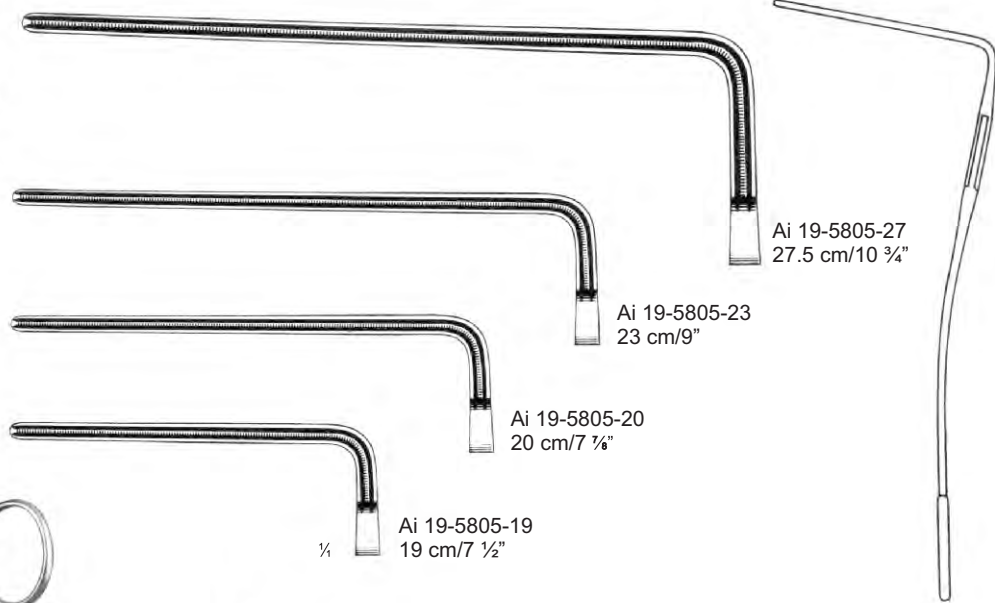
ATRAUMA



DEBAKEY



DEBAKEY

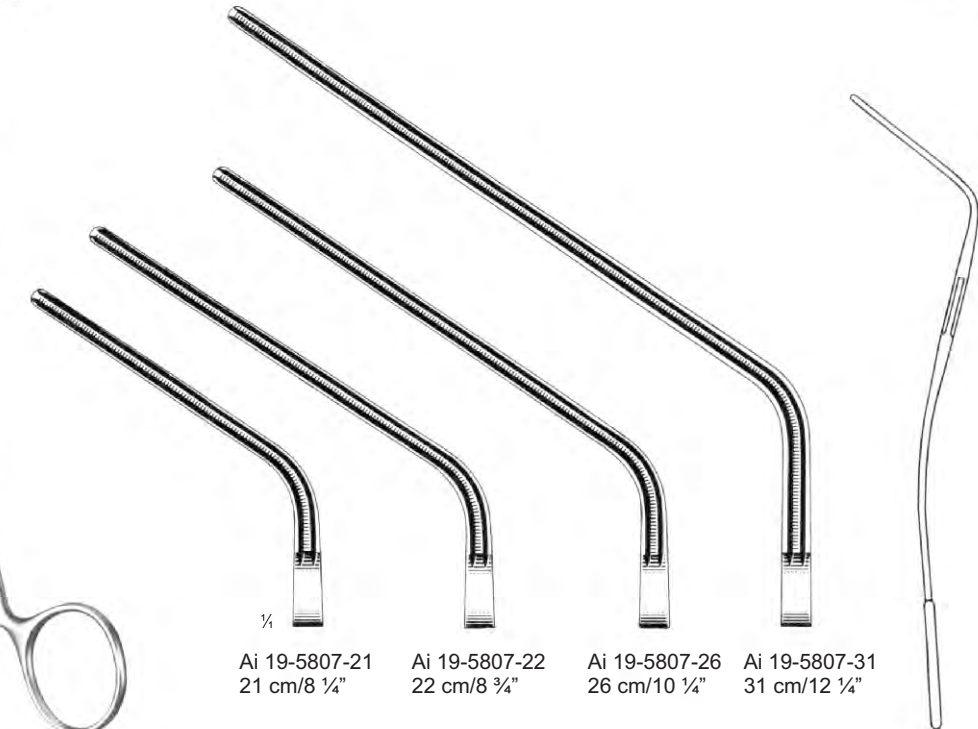


Ai 19-5805-27
27.5 cm/10 3/4"

Ai 19-5805-23
23 cm/9"

Ai 19-5805-20
20 cm/7 1/4"

Ai 19-5805-19
19 cm/7 1/2"



Ai 19-5807-21
21 cm/8 1/4"

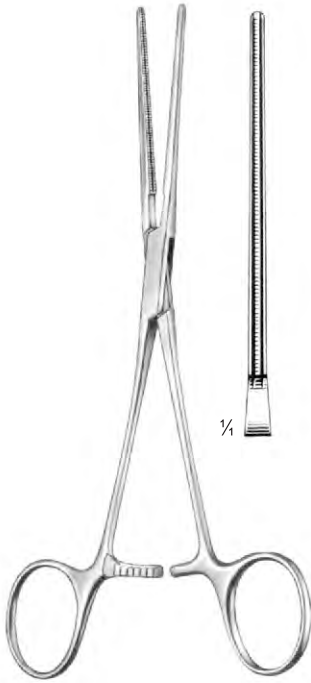
Ai 19-5807-22
22 cm/8 3/4"

Ai 19-5807-26
26 cm/10 1/4"

Ai 19-5807-31
31 cm/12 1/4"



ATRAUMA



DEBAKEY
 Ai 19-5808-17
 17 cm/6 3/4"



DEBAKEY
 Ai 19-5809-16
 16.5 cm/6 1/2"



DEBAKEY
 Ai 19-5810-16
 16 cm/6 1/4"



DEBAKEY
 Ai 19-5811-14
 14.5 cm/5 3/4"



DEBAKEY
 Ai 19-5812-16
 16.5 cm/6 1/2"



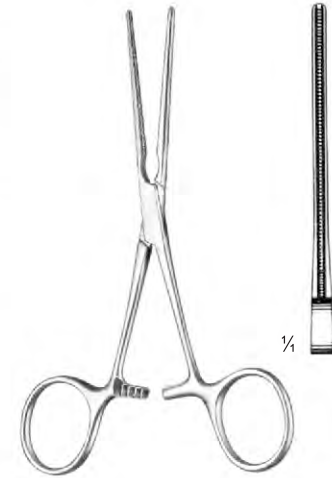
ATRAUMA



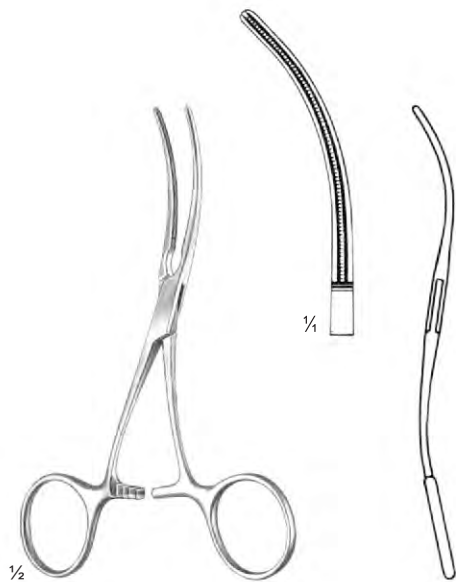
DEBAKEY
 Ai 19-5813-10
 10 cm/3 7/8"



DEBAKEY
 Ai 19-5814-12
 12.5 cm/4 7/8"



DEBAKEY
 Ai 19-5815-13
 13 cm/5 1/8"

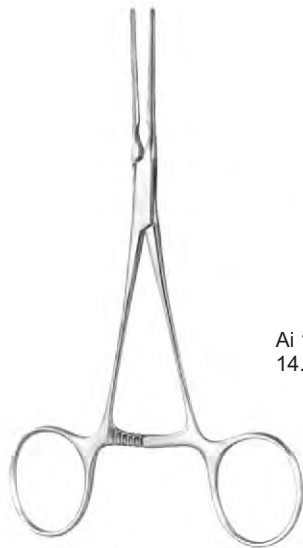


DEBAKEY
 Ai 19-5816-12
 12.5 cm/4 7/8"



DEBAKEY
 Ai 19-5817-12
 12.5 cm/4 7/8"

ATRAUMA



1/4
 Ai 19-5818-14
 14.5 cm/5 3/4"

COOLEY



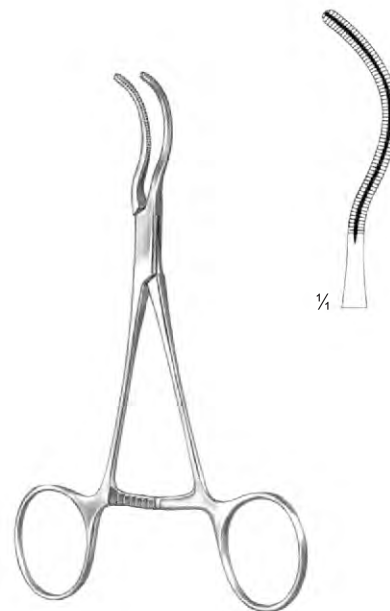
1/4
 Ai 19-5819-14
 14.5 cm/5 3/4"



1/2
COOLEY
 Ai 19-5820-14
 14 cm/5 1/2"



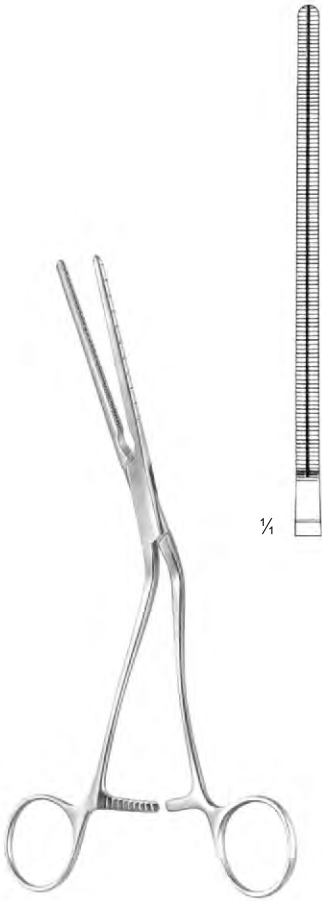
1/4
COOLEY
 Ai 19-5821-14
 14 cm/5 1/2"



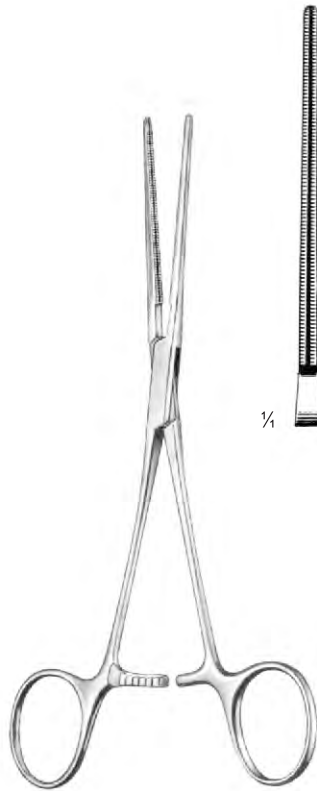
1/4
COOLEY
 Ai 19-5822-14
 14.5 cm/5 3/4"



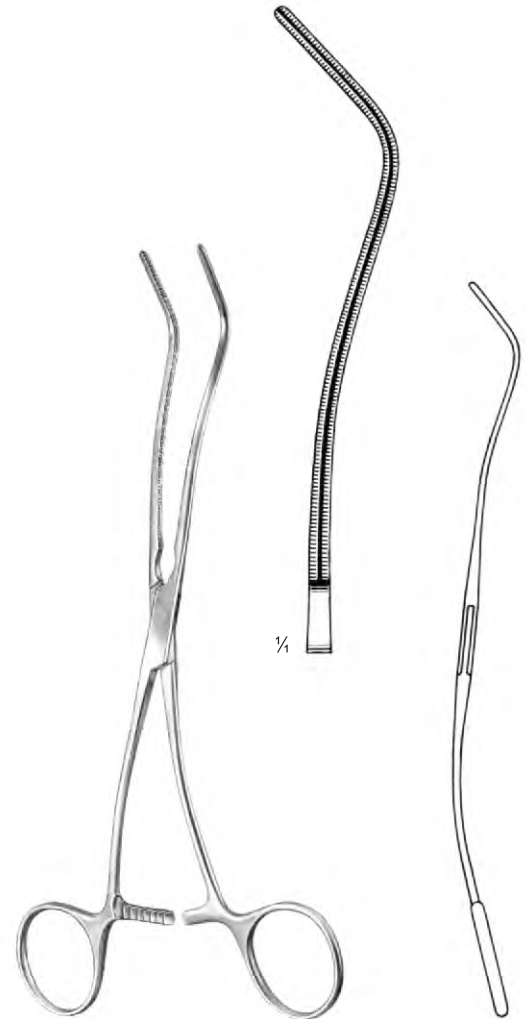
ATRAUMA



COOLEY
Ai 19-5823-22 22 cm/8 3/4"
Ai 19-5823-25 25 cm/12"
Liac Clamp



COOLEY
Ai 19-5824-17
17 cm/6 3/4"

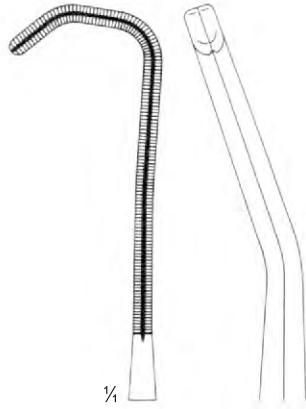


COOLEY
Ai 19-5825-20
20 cm/7 1/4"
Carotid Clamps

ATRAUMA



COOLEY
 Ai 19-5826-17
 17 cm/6 3/4"



COOLEY
 Ai 19-5827-16
 16 cm/6 1/4"



COOLEY
 Ai 19-5828-14
 14 cm/5 1/2"



COOLEY
 Ai 19-5829-16
 16 cm/6 1/4"



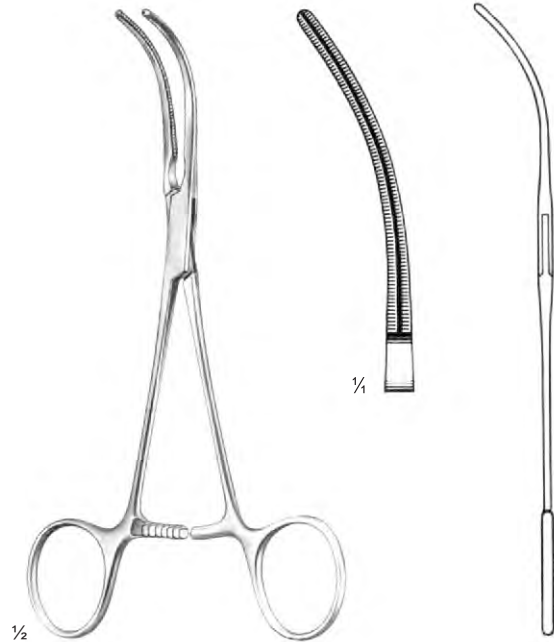
COOLEY
 Ai 19-5830-16
 16.5 cm/6 1/2"



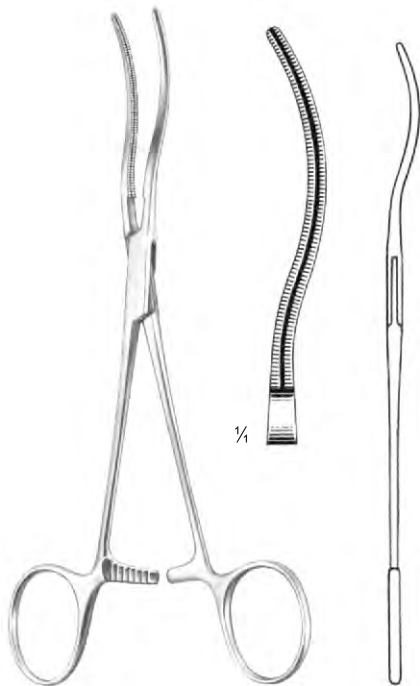
ATRAUMA



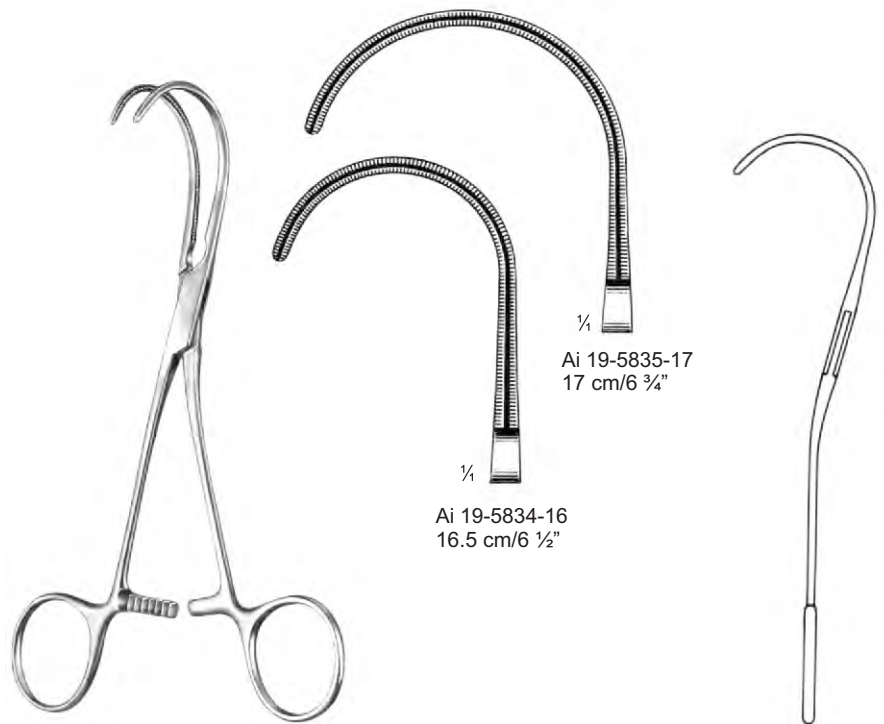
COOLEY
 Ai 19-5831-17
 17 cm/6 3/4"



COOLEY
 Ai 19-5832-17
 17 cm/6 3/4"



COOLEY
 Ai 19-5833-17
 17.5 cm/6 7/8"



COOLEY
 Ai 19-5834-16
 16.5 cm/6 1/2"

Ai 19-5835-17
 17 cm/6 3/4"



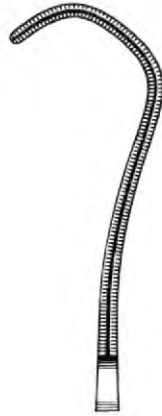
ATRAUMA



COOLEY-DERRA



Ai 19-5836-16
 16.5 cm/6 1/2"



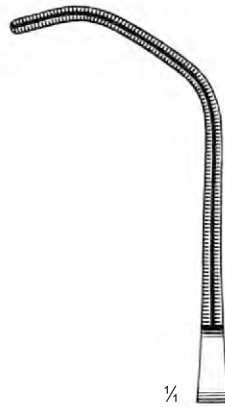
Ai 19-5837-17
 17 cm/6 3/4"



Ai 19-5838-18
 17.5 cm/6 7/8"



COOLEY-BECK
 Ai 19-5839-17
 17 cm/6 3/4"

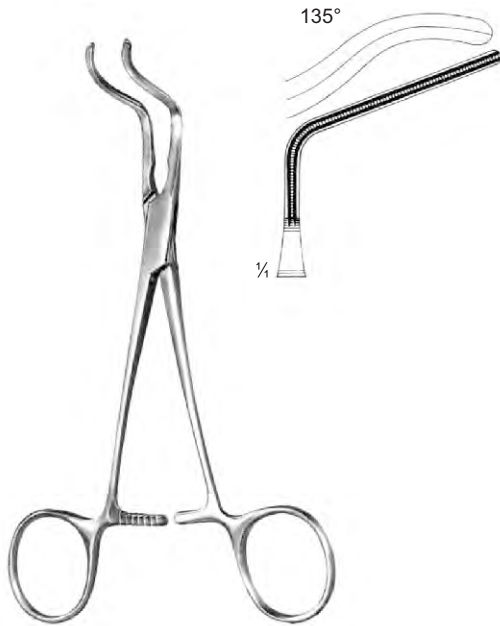


1/4





ATRAUMA



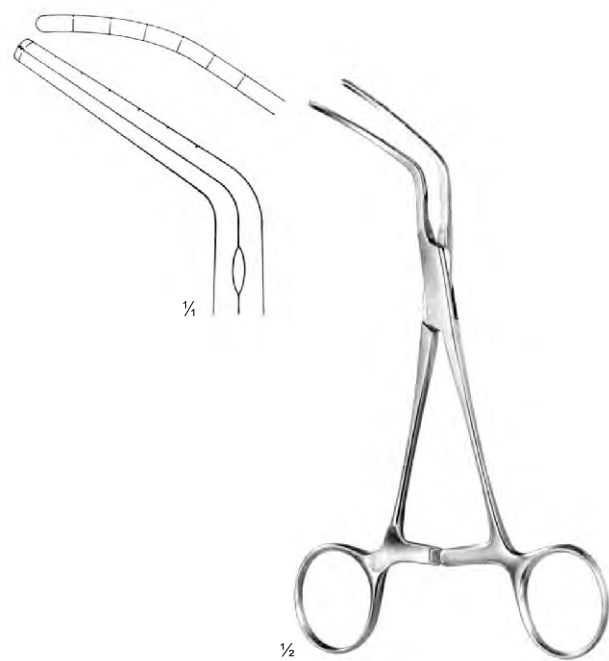
SUBRAMANIAN-MINIATURE
 Ai 19-5840-15
 15.5 cm/6 1/8"



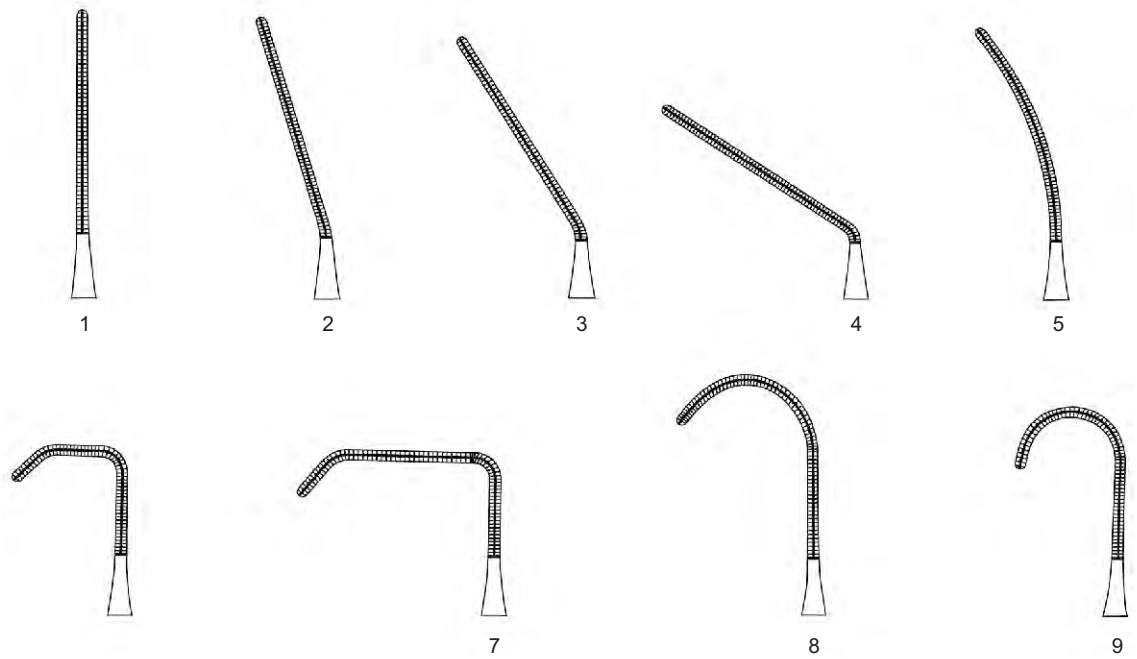
DE BAKEY
 Ai 19-5840-27
 27.0cm



SUBRAMANIAN
 Ai 19-5841-16
 16 cm/6 1/4"



SUBRAMANIAN
 Ai 19-5842-16
 16 cm/6 1/4"



1 Ai 19-5843-01 14.5cm
 2 Ai 19-5843-02 14.5cm
 3 Ai 19-5843-03 14.5cm
 4 Ai 19-5843-04 13.5cm
 5 Ai 19-5843-05 14.0cm
 6 Ai 19-5843-06 13.5cm
 7 Ai 19-5843-07 13.5cm
 8 Ai 19-5843-08 14.0cm
 9 Ai 19-5843-09 13.5cm



1 Ai 19-5843-11 14.5cm
 2 Ai 19-5843-12 14.5cm
 3 Ai 19-5843-13 14.5cm
 4 Ai 19-5843-14 13.5cm
 5 Ai 19-5843-15 14.0cm
 6 Ai 19-5843-16 13.5cm
 7 Ai 19-5843-17 13.5cm
 8 Ai 19-5843-18 14.0cm
 9 Ai 19-5843-19 13.5cm

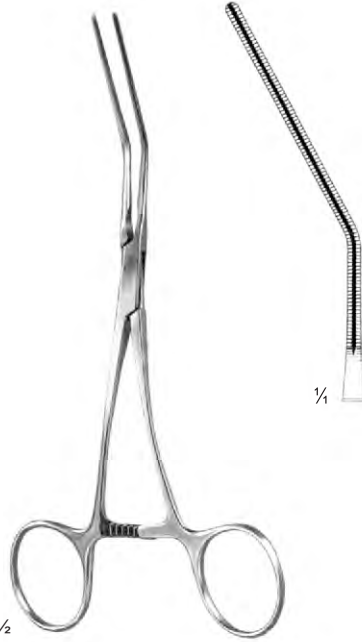


1 Ai 19-5843-21 14.5cm
 2 Ai 19-5843-22 14.5cm
 3 Ai 19-5843-23 14.5cm
 4 Ai 19-5843-24 13.5cm
 5 Ai 19-5843-25 14.0cm
 6 Ai 19-5843-26 13.5cm
 7 Ai 19-5843-27 13.5cm
 8 Ai 19-5843-28 14.0cm
 9 Ai 19-5843-29 13.5cm

ATRAUMA



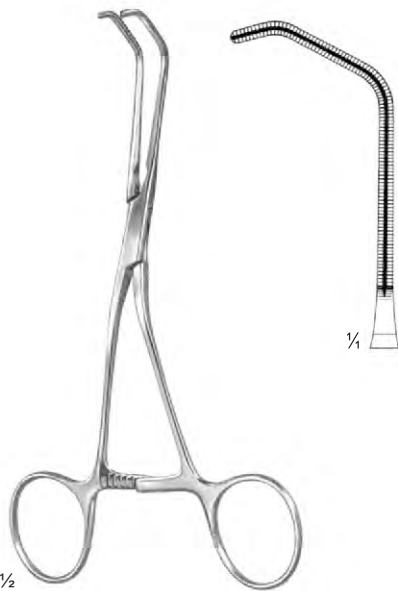
COOLEY
 Ai 19-5844-16
 16.5 cm/6 1/2"



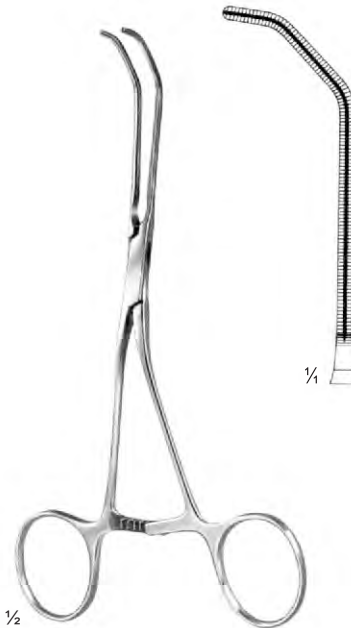
COOLEY
 Ai 19-5845-16
 16 cm/6 1/4"



COOLEY
 Ai 19-5846-15
 15.5 cm/6 1/8"

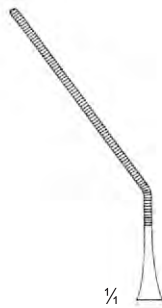


COOLEY
 Ai 19-5847-15
 15.5 cm/6 1/8"



COOLEY
 Ai 19-5848-16
 16 cm/6 1/4"

ATRAUMA



Ai 19-5849-01
 12.5 cm/4 7/8"



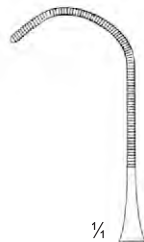
Ai 19-5849-02
 11.5 cm/4 1/2"



Ai 19-5849-03
 11 cm/4 3/8"



CASTANEDA



Ai 19-5849-04
 11.5 cm/4 1/2"



Ai 19-5849-05
 12 cm/4 3/4"



Ai 19-5849-06
 12 cm/4 3/4"



Ai 19-5849-07
 12 cm/4 3/4"



ATRAUMA



ALLIS

¼

Ai 19-5850-16
 16 cm/6 ½"

Ai 19-5850-20
 20 cm/7 7/8"

Ai 19-5850-25
 25 cm/10"

Ai 19-5850-30
 30 cm/11 ¾"

ATRAUMA

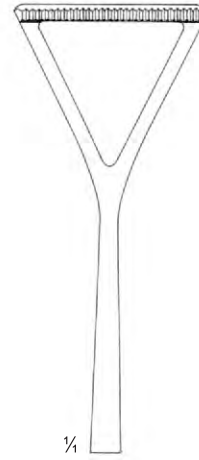


DUVAL



13 mm

- Ai 19-5851-18 18 cm
- Ai 19-5851-20 20 cm
- Ai 19-5851-23 23 cm



25 mm

- Ai 19-5852-18
- Ai 19-5852-20
- Ai 19-5852-23





ATRAUMA



Ai 19-5853-25
25 cm/9 7/8"



Ai 19-5853-26
26 cm/10 1/4"



SCHEIBE



Ai 19-5854-18
18 cm/7 1/8"
narrow



Ai 19-5854-20
20.5 cm/8 1/8"
medium



Ai 19-5854-23
23 cm/9"
wide

ATRAUMA



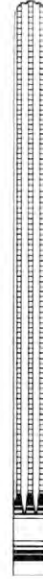
DOYEN-ATRAUMA



Ai 19-5855-14
14 cm/5 1/2"



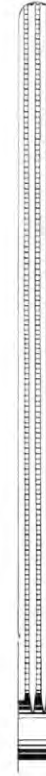
Ai 19-5855-16
16 cm/6 3/4"



Ai 19-5855-18
18.5 cm/7 1/4"



Ai 19-5855-21
21.5 cm/8 1/2"



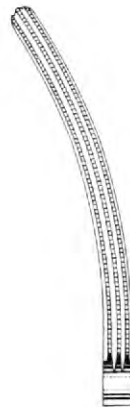
Ai 19-5855-23
23.5 cm/9 1/4"



DOYEN-ATRAUMA



Ai 19-5856-13
13.5 cm/5 3/8"



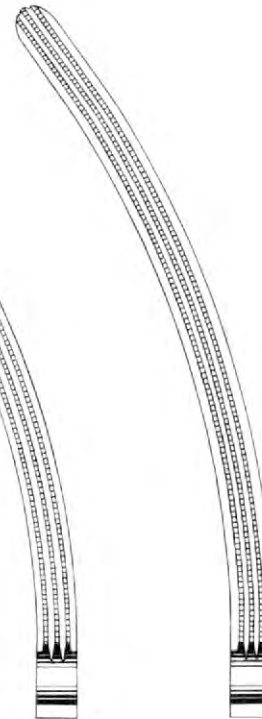
Ai 19-5856-16
16 cm/6 3/4"



Ai 19-5856-18
18 cm/7 1/8"



Ai 19-5856-21
21 cm/8 1/4"



Ai 19-5856-23
23 cm/9"

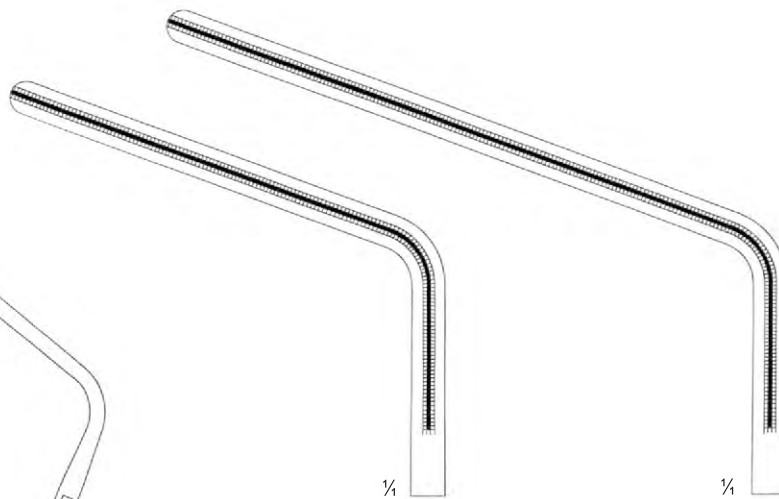




ATRAUMA



HAYES



Ai 19-5857-26
 26 cm/10 1/2"

Ai 19-5857-28
 28 cm/11"

ATRAUMA



VEIDENHEIMER
Ai 19-5858-25
25 cm/9 7/8"



FEHLAND
Ai 19-5859-24
24 cm/9 1/2"



ATRAUMA



RESANO
 Ai 19-5860-30
 30 cm/12"

- EN** Tonsil
DE Mandel
ES Amígdala

Page 499 to 511





Luniatschek
 Ai 20-6151-19
 19 cm



Luniatschek
 Ai 20-6152-19
 19 cm

Gauze Packers



Day
 Ai 20-6153-21
 21.5 cm



Hurd
 Ai 20-6154-01
 21 cm



Hurd
 Ai 20-6154-02
 21 cm



Nager
 Ai 20-6155-24
 24 cm/9½"



Falk
 Ai 20-6156-24
 24 cm/9½"



Falk
 Ai 20-6157-24
 24 cm/9½"

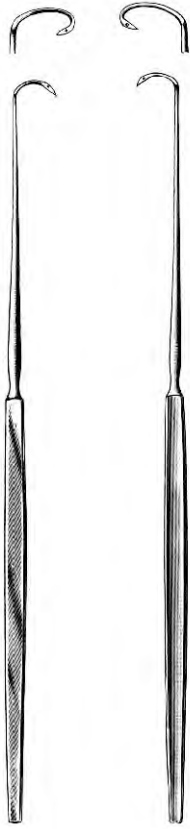


Claus-Eicken
 Ai 20-6158-23
 23 cm/9"



DURHAM
 Ai 20-6159-01 25.0cm Ai 20-6159-02





ROTTER
 Ai 20-6160-01 26.0cm Ai 20-6160-02



Fischer
 Ai 20-6161-22
 22.5 cm/8⁷/₈"



Douglas
 Ai 20-6162-21
 21 cm/8¹/₄"



Abraham
 Ai 20-6163-21
 21 cm/8¹/₄"



Bruenings
 Ai 20-6164-23
 23 cm/9"



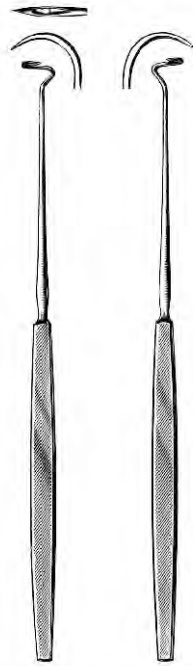
Tydins
 Ai 20-6165-21
 21 cm



Canfield
 Ai 20-6166-21
 21 cm/8¹/₄"



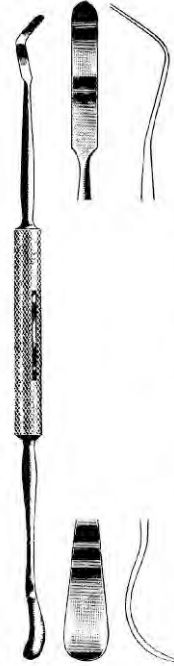
Colver
 Ai 20-6167-22
 22.5cm



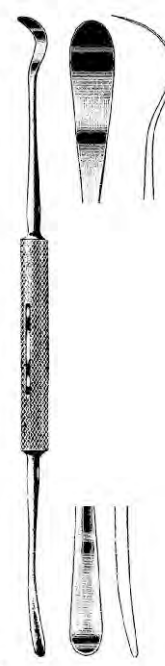
Dupy-Weiss
 Ai 20-6168-01 22.0cm Ai 20-6168-02



Lynch
 Ai 20-6169-20
 20.0cm



Carpenter
 Ai 20-6170-25
 25.0cm



Carpenter
 Ai 20-6171-24
 24.0cm



Marschik
 Ai 20-6172-22
 22.0cm





Negus Knot Tier and Pusher
 Ai 20-6173-20
 20cm/8"



Molison Pillar double ended
 Ai 20-6174-21
 21cm/8 1/4"



Gwynee Evans Dissector double ended
 Ai 20-6175-06
 6mm, 20cm/8"
 Ai 20-6175-08
 8mm, 20cm/8"



Hurd
 Ai 20-6176-22
 22.5 cm/8 7/8"



Yankauer
 Ai 20-6177-21
 21 cm/8 1/4"



Ai 20-6178-01

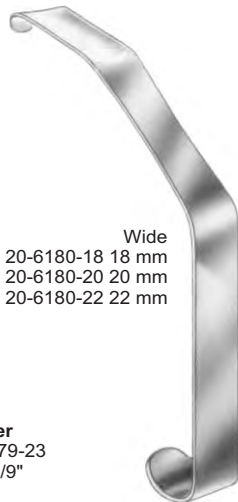


Henke
 23 cm/9"

Ai 20-6178-02



Nager
 Ai 20-6179-23
 23 cm/9"



Wide
 Ai 20-6180-18 18 mm
 Ai 20-6180-20 20 mm
 Ai 20-6180-22 22 mm

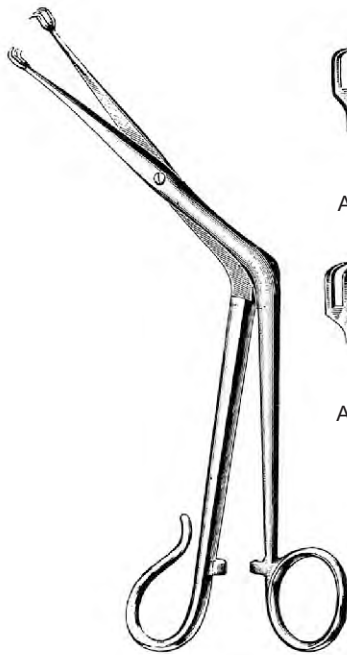
Love
 23 cm/9"



Haslinger
 Ai 20-6181-16



Hofer
 Ai 20-6182-24
 24 cm/9 1/2"



TIVNEN-TYDING
21.0cm



Fig. 1

Ai 20-6183-01

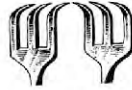
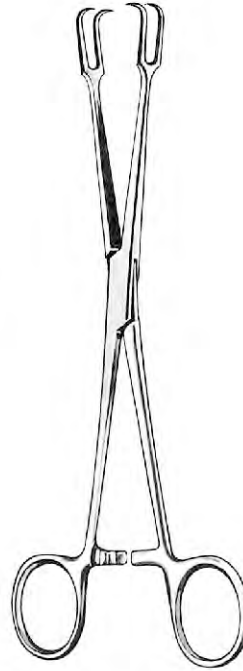


Fig. 2

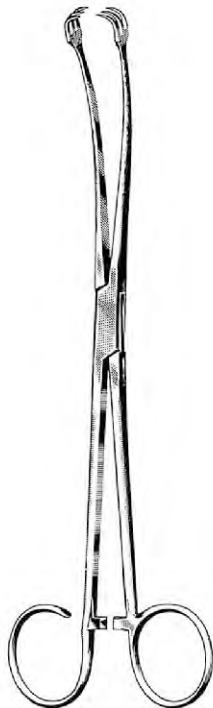
Ai 20-6183-02



MUSEUX
Ai 20-6184-20
20.0cm



MUSEUX
Ai 20-6185-20
20.0cm



BALLENGER
Ai 20-6186-21
21.5cm



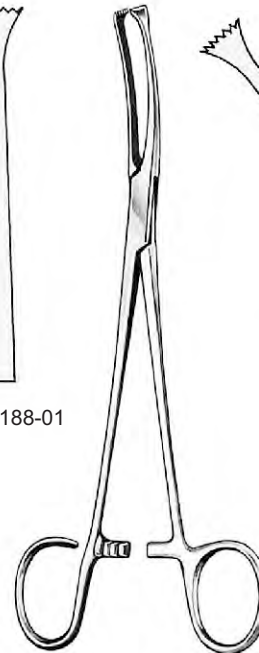
WHITE
Ai 20-6187-18 18.0cm
Ai 20-6187-23 23.0cm



Ai 20-6188-01

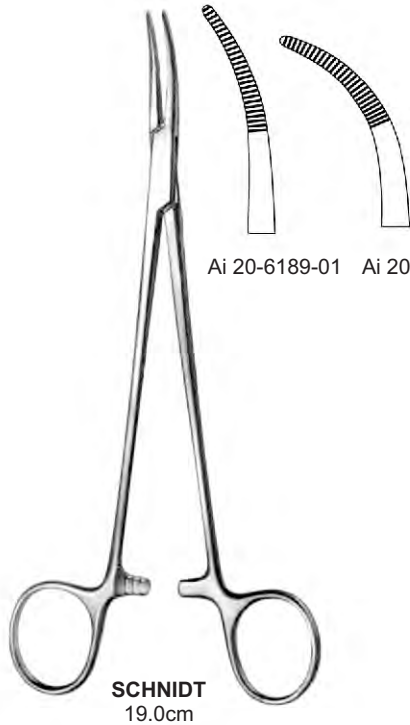


Ai 20-6188-02

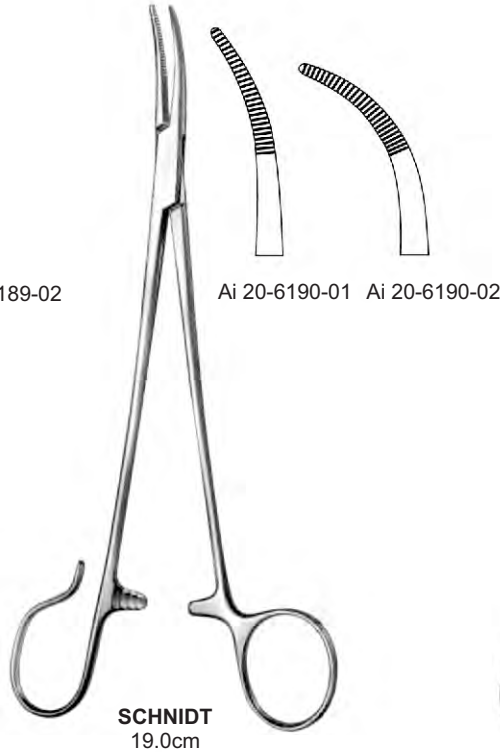


COLVER
19.0cm

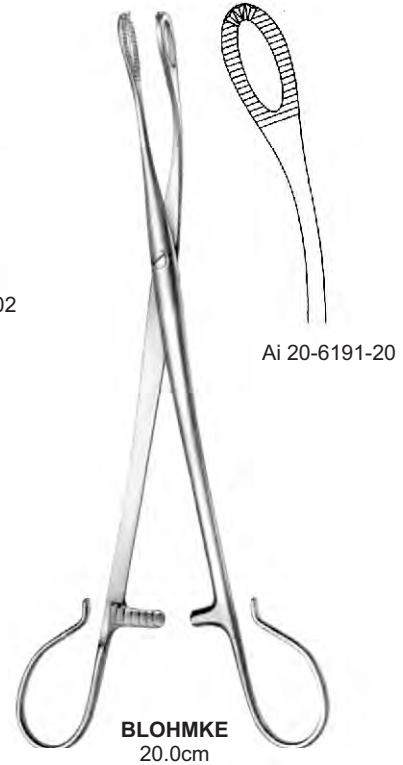




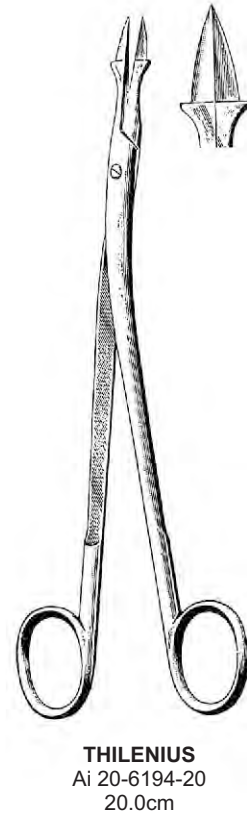
Ai 20-6189-01 Ai 20-6189-02

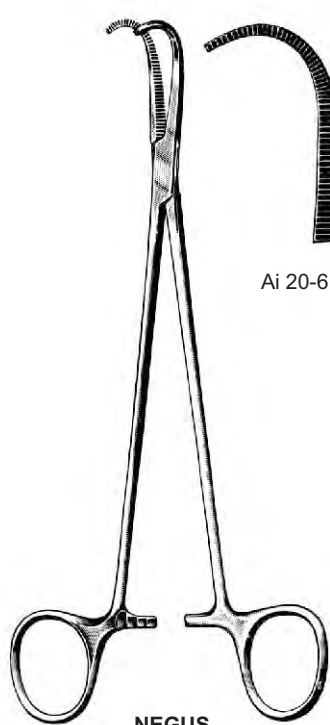


Ai 20-6190-01 Ai 20-6190-02



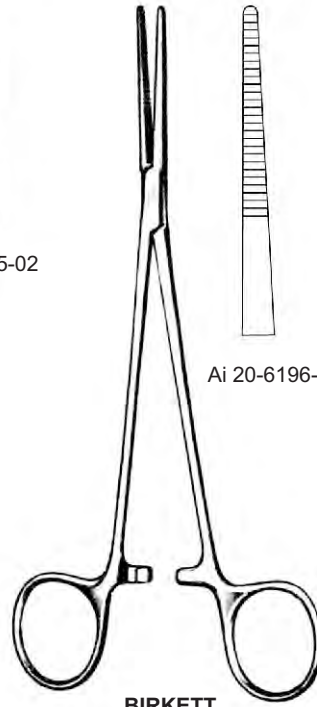
Ai 20-6191-20





NEGUS
 19.0cm

Ai 20-6195-01 Ai 20-6195-02

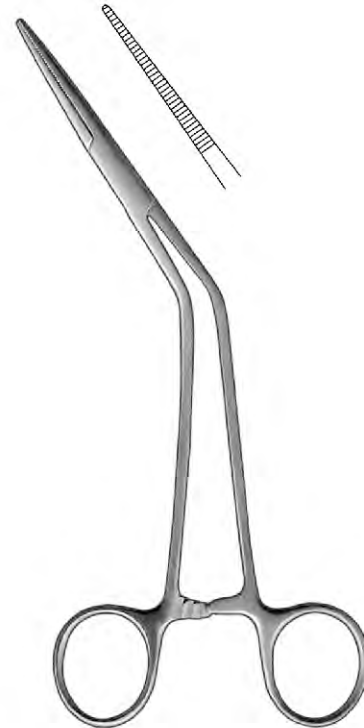


BIRKETT
 19.0cm

Ai 20-6196-01 Ai 20-6196-02 Ai 20-6196-03



WILSON
 Ai 20-6197-19
 19.0cm



MOLLISON
 Ai 20-6198-01 18.0cm (with horizontal opening)
 Ai 20-6198-02 18.0cm (with vertical opening)





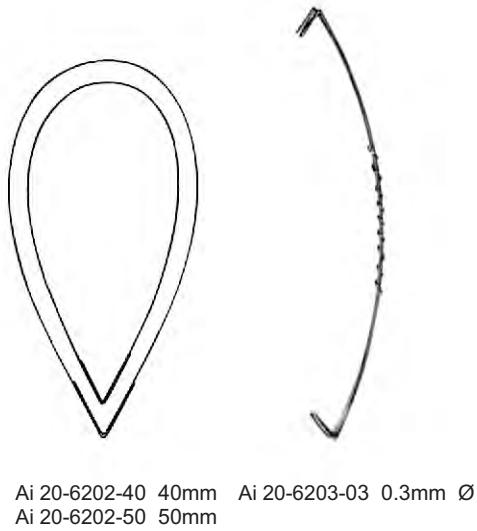
Eves
 Ai 20-6199-28
 28 cm/11"



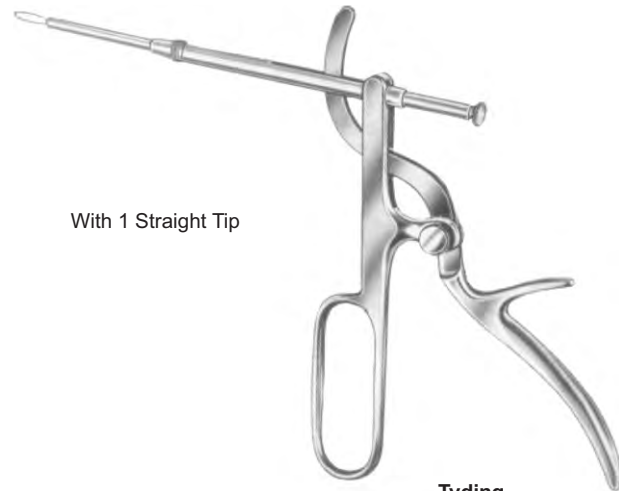
Eves
 Ai 20-6200-28
 28 cm/11"



Bruenings
 Ai 20-6201-28
 28 cm/11"



Ai 20-6202-40 40mm Ai 20-6203-03 0.3mm Ø
 Ai 20-6202-50 50mm



With 1 Straight Tip

Tyding
 Ai 20-6204-00



Ai 20-6205-01 Ai 20-6205-02 Ai 20-6205-03

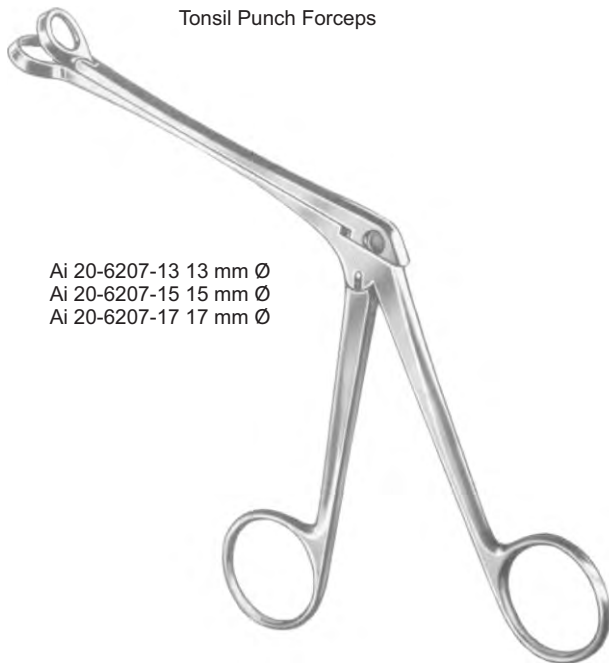


Sluder-Ballenger
 Complete, With 3 Tips
 Ai 20-6205-00

Tonsil Haemostats



Corwin
 Ai 20-6206-14
 14 cm/5½"



Tonsil Punch Forceps

Ai 20-6207-13 13 mm Ø
 Ai 20-6207-15 15 mm Ø
 Ai 20-6207-17 17 mm Ø

Hartmann



Luc Forceps
 Ai 20-6208-01 Small
 Ai 20-6208-02 Medium
 Ai 20-6208-03 Large
 20cm/8"

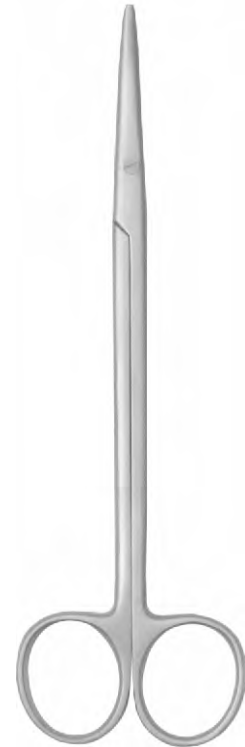




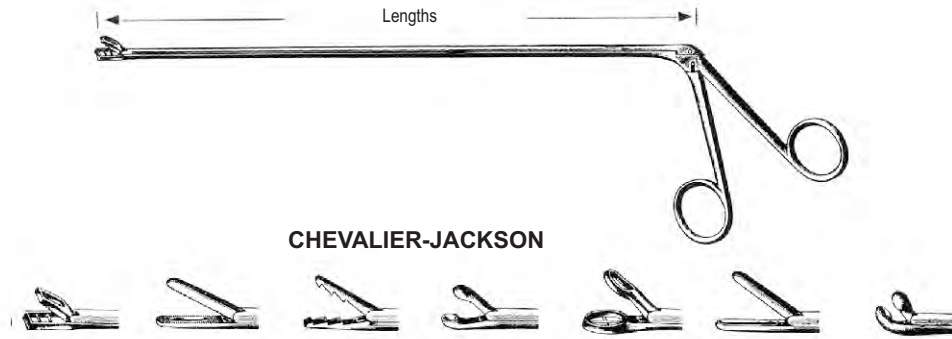
Waugh Dissecting Forcep
 Ai 20-6209-20
 1 x 2 teeth
 20cm/8"



Waugh Dissecting Forcep
 Ai 20-6210-20
 serrated
 20cm/8"



Metzenbaum Scissor Cvd.
 Ai 20-6211-18
 18cm/7"



CHEVALIER-JACKSON

30.0cm	Ai 20-6212-30	Ai 20-6213-30	Ai 20-6214-30	Ai 20-6215-30	Ai 20-6216-30	Ai 20-6217-30	Ai 20-6218-30
40.0cm	Ai 20-6212-40	Ai 20-6213-40	Ai 20-6214-40	Ai 20-6215-40	Ai 20-6216-40	Ai 20-6217-40	Ai 20-6218-40
50.0cm	Ai 20-6212-50	Ai 20-6213-50	Ai 20-6214-50	Ai 20-6215-50	Ai 20-6216-50	Ai 20-6217-50	Ai 20-6218-50
60.0cm	Ai 20-6212-60	Ai 20-6213-60	Ai 20-6214-60	Ai 20-6215-60	Ai 20-6216-60	Ai 20-6217-60	Ai 20-6218-60



HUBER
 Ai 20-6219-00



BRUENINGS (straight)

- Ai 20-6219-20 20.0cm
- Ai 20-6219-30 30.0cm
- Ai 20-6219-40 40.0cm
- Ai 20-6219-50 50.0cm
- Ai 20-6219-60 60.0cm



BRUENINGS
 Ai 20-6220-00



BRUENINGS

- Ai 20-6221-20
- 20.0cm





FRAENKEL
Ai 20-6222-00



BARACANI
Ai 20-6223-00



SEIFFERT
Ai 20-6224-00



FRAENKEL
Ai 20-6225-00



BRUENINGS
Ai 20-6226-01
Ai 20-6226-02



BRUENINGS
Ai 20-6227-01
Ai 20-6227-02



LANGE
Ai 20-6228-00



KRAUSE
Ai 20-6229-01
Ai 20-6229-02



SCHUMACHER
Ai 20-6230-00



CORDES
Ai 20-6231-01
Ai 20-6231-02



CORDES
Ai 20-6232-00



ROSENBERG
Ai 20-6233-00



KRAUSE
Ai 20-6234-00



CORDES
Ai 20-6235-01
Ai 20-6235-02
Ai 20-6235-03
Ai 20-6235-04



SCHEINMANN
Ai 20-6236-00



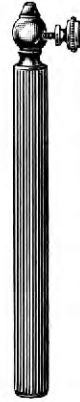
SCHEINMANN
Ai 20-6237-00



Ai 20-6238-11



Ai 20-6239-10



Ai 20-6240-11



Ai 20-6241-12



Ai 20-6242-00



MICHEL
 25.0cm



Ai 20-6243-12



Ai 20-6243-14



Ai 20-6243-16



Ai 20-6243-18



Ai 20-6244-08
 Ai 20-6244-10
 Ai 20-6244-12
 Ai 20-6244-14
 Ai 20-6244-16
 Ai 20-6244-18
 Ai 20-6244-20
 Ai 20-6244-22
 Ai 20-6244-24
 Ai 20-6244-26
 Ai 20-6244-28
 Ai 20-6244-30

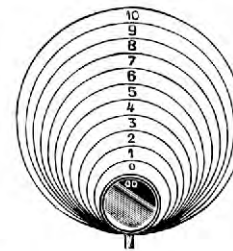


fig.00, 8mm Ø
 fig.0, 10mm Ø
 fig.1, 12mm Ø
 fig.2, 14mm Ø
 fig.3, 16mm Ø
 fig.4, 18mm Ø
 fig.5, 20mm Ø
 fig.6, 22mm Ø
 fig.7, 24mm Ø
 fig.8, 26mm Ø
 fig.9, 28mm Ø
 fig.10, 30mm Ø



Ai 20-6245-08
 Ai 20-6245-10
 Ai 20-6245-12
 Ai 20-6245-14
 Ai 20-6245-16
 Ai 20-6245-18
 Ai 20-6245-20
 Ai 20-6245-22
 Ai 20-6245-24
 Ai 20-6245-26
 Ai 20-6245-28
 Ai 20-6245-30





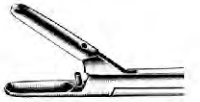
Ai 20-6246-01



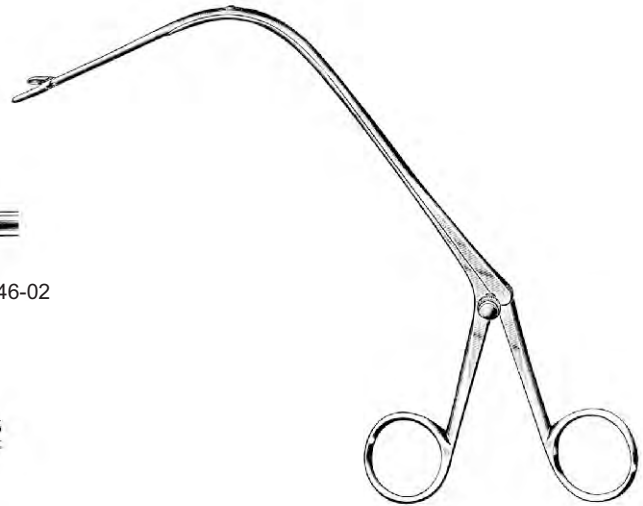
Ai 20-6246-02



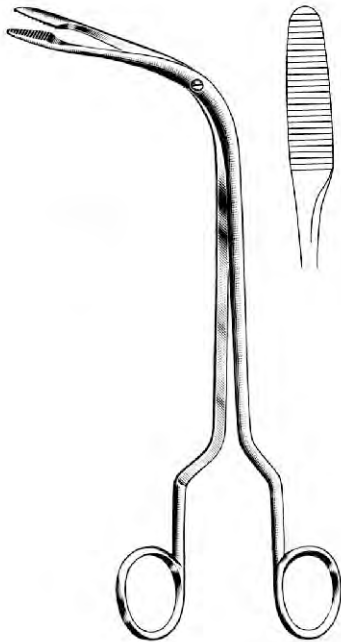
Ai 20-6246-03



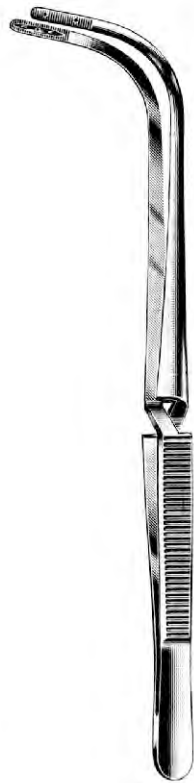
Ai 20-6246-04



JURASZ
23.0cm



FRAENKEL
Ai 20-6247-19
19.0cm



JACKSON
22.0cm



Ai 20-6248-22



Ai 20-6248-22



REICHERT
Ai 20-6249-24
24.0cm

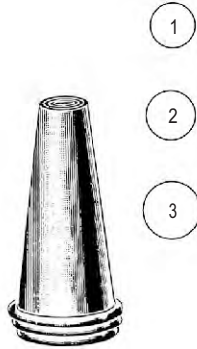
EN Otolology

DE Otologie

ES Otología

Page 512 to 540





TROELTSCH
 Ai 21-6301-00 set/3
 Ai 21-6301-01 6mm Ø, Fig. 1
 Ai 21-6301-02 7mm Ø, Fig. 2
 Ai 21-6301-03 8mm Ø, Fig. 3



HARTMANN (for children)
 Ai 21-6302-00 set/3
 Ai 21-6302-01 4mm Ø, Fig. 1
 Ai 21-6302-02 5mm Ø, Fig. 2



HARTMANN (for adults)
 Ai 21-6303-00 set/4
 Ai 21-6303-01 4.0mm Ø, Fig. 1
 Ai 21-6303-02 5.0mm Ø, Fig. 2
 Ai 21-6303-03 6.0mm Ø, Fig. 3
 Ai 21-6303-04 7.5mm Ø, Fig. 4



TOYNBEE (for adults)
 Ai 21-6304-00 set/4
 Ai 21-6304-01 4mm Ø, Fig. 1
 Ai 21-6304-02 5mm Ø, Fig. 2
 Ai 21-6304-03 6mm Ø, Fig. 3
 Ai 21-6304-04 7mm Ø, Fig. 4



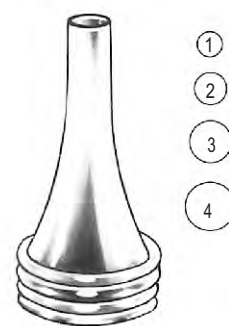
GRUBER (for adults)
 Ai 21-6305-00 set/4
 Ai 21-6305-01 4.5mm Ø, Fig. 1
 Ai 21-6305-02 5.5mm Ø, Fig. 2
 Ai 21-6305-03 6.5mm Ø, Fig. 3
 Ai 21-6305-04 7.5mm Ø, Fig. 4



GRUBER
 Ai 21-6306-00 set/4
 Ai 21-6306-01 4.5mm Ø, Fig. 1
 Ai 21-6306-02 5.5mm Ø, Fig. 2
 Ai 21-6306-03 6.5mm Ø, Fig. 3
 Ai 21-6306-04 7.5mm Ø, Fig. 4



GRUBER
 Ai 21-6307-00 set/4
 Ai 21-6307-01 4.5mm Ø, Fig. 1
 Ai 21-6307-02 5.5mm Ø, Fig. 2
 Ai 21-6307-03 6.5mm Ø, Fig. 3
 Ai 21-6307-04 7.5mm Ø, Fig. 4

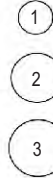


POLTZER
 Ai 21-6308-00 set/4
 Ai 21-6308-01 3.0mm Ø, Fig. 1
 Ai 21-6308-02 4.5mm Ø, Fig. 2
 Ai 21-6308-03 5.5mm Ø, Fig. 3
 Ai 21-6308-04 6.5mm Ø, Fig. 4



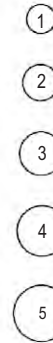
ERHARDT

- Ai 21-6309-00 set/3
- Ai 21-6309-01 4.5mm Ø, Fig. 1
- Ai 21-6309-02 5.5mm Ø, Fig. 2
- Ai 21-6309-03 6.5mm Ø, Fig. 3



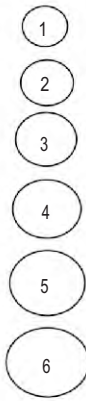
PRITCHARD

- Ai 21-6310-00 set/3
- Ai 21-6310-01 4.5mm Ø, Fig. 1
- Ai 21-6310-02 6.5mm Ø, Fig. 2
- Ai 21-6310-03 7.5mm Ø, Fig. 3



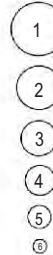
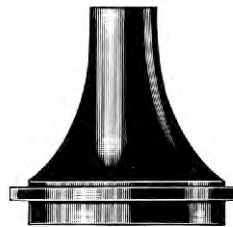
BOUCHERON

- Ai 21-6311-00 set/5
- Ai 21-6311-01 4.0mm Ø, Fig. 1
- Ai 21-6311-02 5.0mm Ø, Fig. 2
- Ai 21-6311-03 6.0mm Ø, Fig. 3
- Ai 21-6311-04 7.0mm Ø, Fig. 4
- Ai 21-6311-05 8.0mm Ø, Fig. 5



ZÖLLNER

- Ai 21-6312-00 set/6
- Ai 21-6312-01 5.5x6.5mm Ø, Fig. 1
- Ai 21-6312-02 6.5x7.5mm Ø, Fig. 2
- Ai 21-6312-03 7.5x8.5mm Ø, Fig. 3
- Ai 21-6312-04 8.5x9.5mm Ø, Fig. 4
- Ai 21-6312-05 9.5x10.5mm Ø, Fig. 5
- Ai 21-6312-06 10.5x11.5mm Ø, Fig. 6



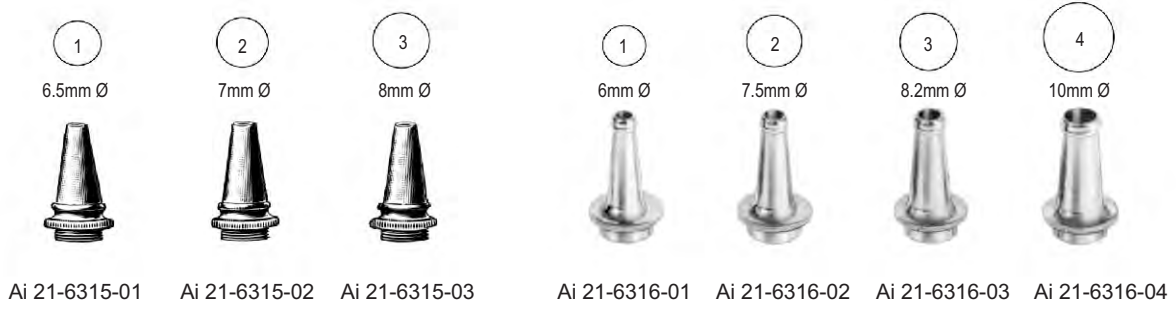
- Ai 21-6313-00 set/6
- Ai 21-6313-01 7.5mm Ø, Fig. 1
- Ai 21-6313-02 6.0mm Ø, Fig. 2
- Ai 21-6313-03 5.0mm Ø, Fig. 3
- Ai 21-6313-04 4.0mm Ø, Fig. 4
- Ai 21-6313-05 3.0mm Ø, Fig. 5
- Ai 21-6313-06 2.0mm Ø, Fig. 6



RICHNAU HOLMGREN

- Ai 21-6314-02 Ø 2mm
- Ai 21-6314-03 Ø 3mm
- Ai 21-6314-04 Ø 4mm
- Ai 21-6314-05 Ø 5mm
- Ai 21-6314-06 Ø 6mm





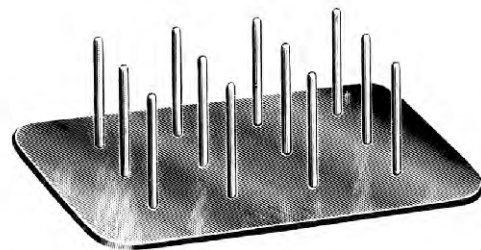
SIEGLE
 Ai 21-6315-00 set
 Ai 21-6315-04 otoscope
 Ai 21-6315-05 rubber bulb
 Ai 21-6315-01,02,03 speculas



Ai 21-6316-00 Compl.



BRUENINGS
 Ai 21-6316-05 set of 4 speculas
 Ai 21-6316-06 rubber bulb
 Ai 21-6316-07 wooden case only
 Ai 21-6316-10 otoscope



Ai 21-6317-01
 support for specula



Ai 21-6318-01 Ai 21-6318-02 Ai 21-6318-03 Ai 21-6318-04
cannula



Ai 21-6318-05
valve connection



Ai 21-6318-06
suction end

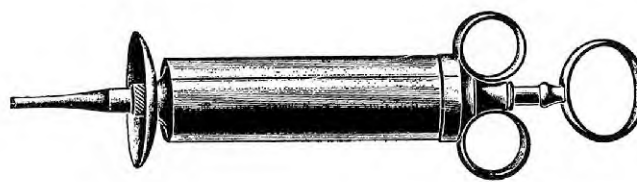


Ai 21-6318-07
protecting disk

Ai 21-6318-08
flexible tube only



Ai 21-6318-50 50ml
Ai 21-6318-75 75ml
Ai 21-6318-10 100ml
ear syringe. complete. Self-filling



Ai 21-6319-01 bulb tip
Ai 21-6319-02 conical tip
Ai 21-6319-03 shield

LUER
Ai 21-6319-04
Ai 21-6319-05
Ai 21-6319-06







PIMERROY
Ai 21-6319-50 50cc
Ai 21-6319-75 75cc
Ai 21-6319-10 100cc
Ai 21-6319-15 150cc
Ai 21-6319-20 200cc








LUER
Ai 21-6319-50A
Ai 21-6319-75A
Ai 21-6319-10A
Ai 21-6319-15A
Ai 21-6319-20A

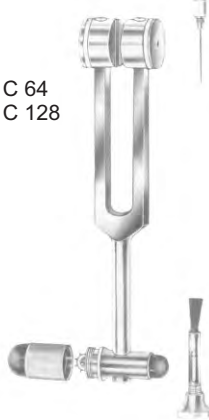




Tuning Forks

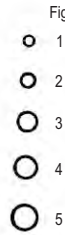
 Hartmann Ai 21-6320-00 Ai 21-6320-01 Ai 21-6320-02 Ai 21-6320-03 Ai 21-6320-04 Ai 21-6320-05	 Lucae Ai 21-6321-00 Ai 21-6321-01 Ai 21-6321-02 Ai 21-6321-03 Ai 21-6321-04 Ai 21-6321-05	 French Hartmann Ai 21-6322-16 Ai 21-6322-32 Ai 21-6322-01 Ai 21-6322-02 Ai 21-6322-03	 Lucae C 128 Variable up to h (Engl. B) Ai 21-6323-00	 Hartmann C 128 Ai 21-6324-00	 Rydel-Seiffer Ai 21-6325-00 C 64/C 128
--	---	--	---	--	--

 Ai 21-6327-01 C 64	 Ai 21-6327-02 C 128	 Ai 21-6327-03 C 256	 Ai 21-6327-04 C 512 aluminum	 Ai 21-6327-05 C 1024 aluminum	 Ai 21-6327-06 C 2048 aluminum	 Ai 21-6327-07 C 4096 aluminum
--	---	---	---	--	--	--


 With Clamps = C 64
 Without Clamps = C 128
 Tuning Fork for neurological examination, with percussion hammer, pin wheel, brush and needle
 Ai 21-6326-00



TROELTSCH
 Ai 21-6328-01 Fig. 1
 Ai 21-6328-02 Fig. 2
 Ai 21-6328-03 Fig. 3
 Ai 21-6328-04 Fig. 4
 Ai 21-6328-05 Fig. 5



LUCAE
 Ai 21-6329-01 Fig. 1
 Ai 21-6329-02 Fig. 2
 Ai 21-6329-03 Fig. 3
 Ai 21-6329-04 Fig. 4
 Ai 21-6329-05 Fig. 5



WOAKES
 Ai 21-6330-01



HARTMANN
 Ai 21-6331-02 Fig. 2
 Ai 21-6331-03 Fig. 3
 Ai 21-6331-04 Fig. 4



HARTMANN
 Ai 21-6332-00 Fig. 0
 Ai 21-6332-01 Fig. 1
 Ai 21-6332-02 Fig. 2
 Ai 21-6332-03 Fig. 3
 Ai 21-6332-04 Fig. 4
 Ai 21-6332-05 Fig. 5



HARTMANN
 Ai 21-6333-00 Fig. 0
 Ai 21-6333-01 Fig. 1
 Ai 21-6333-02 Fig. 2
 Ai 21-6333-03 Fig. 3
 Ai 21-6333-04 Fig. 4
 Ai 21-6333-05 Fig. 5



ITARD
 Ai 21-6334-01 Fig. 1
 Ai 21-6334-02 Fig. 2
 Ai 21-6334-03 Fig. 3
 Ai 21-6334-04 Fig. 4
 Ai 21-6334-05 Fig. 5





Krause
 Ai 21-6335-16
 16 cm/6 1/4"



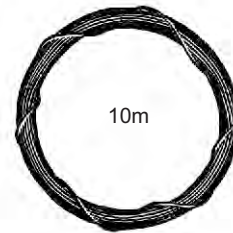
Krause-Voss
 Ai 21-6336-16
 16 cm/6 1/4"



Lange-Wilde
 Ai 21-6337-16
 16 cm/6 1/4"



Package of 1 dozen each
 mm Ø
 Ai 21-6338-02 0.2
 Ai 21-6338-03 0.3



Ai 21-6338-03 0.3mm Ø
 Ai 21-6338-04 0.4mm Ø



TROELTSCH (WILDE)
 Ai 21-6339-13 13.0cm

Ear Dressing Forceps



Cm	In	Troeltsch (Wilde)	
11.0	4 1/4"	Ai 21-6340-11	
12.0	4 3/4"	Ai 21-6340-12	
14.0	5 1/2"	Ai 21-6340-14	
15.0	6"	Ai 21-6340-15	
16.0	6 1/4"		
18.0	7"		
20.0	8"		

Troeltsch	Troeltsch
(Wilde)	1 x 2 teeth
Ai 21-6343-11	Ai 21-6343-11
Ai 21-6343-12	Ai 21-6343-12



Lucae
 Ai 21-6344-14



Lucae
 1 x 2 teeth
 Ai 21-6345-14



Jansen
 Ai 21-6346-16
 Ai 21-6346-18
 Ai 21-6346-20



Okonogto
 Ai 21-6347-16
 16 cm/6 1/4"



Littauer
 Ai 21-6348-12
 12 cm/4 3/4"



Hartmann
 Ai 21-6349-12
 12 cm/4 3/4"

Fine Pattern



Hartmann
 Ai 21-6350-14
 14 cm/5 1/2"

Standard Pattern



Tilley Aural Forcep
 Ai 21-6351-14 14cm/5 1/2"
 Ai 21-6351-16 16cm/6 1/4"
 Ai 21-6351-18 18cm/7"



Buck
 Ai 21-6352-09
 9 cm/3 1/2"



Quire
 Ai 21-6353-08
 8 cm/3 1/4"





Hartmann-Noyes
 Ai 21-6354-09
 8.5 cm/3 1/4"



1 : 2

Hartmann-Noyes
 Ai 21-6355-09
 8.5 cm/3 1/4"



Hartmann
 Ai 21-6356-09 8.5 cm/3 1/4"
 Ai 21-6356-14 14 cm/5 1/2"
 Ai 21-6356-16 16 cm/6 1/4"



1 : 2

Hartmann
 Ai 21-6357-09 8.5 cm/3 1/4"
 Ai 21-6357-14 14.0 cm/5 1/2"



Hartmann
 Ai 21-6358-20 8.5 cm/3 1/4" ○ 2.0 mm
 Ai 21-6358-25 8.5 cm/3 1/4" ○ 2.5 mm
 Ai 21-6358-30 8.5 cm/3 1/4" ○ 3.0 mm



Hartmann-Citelli
 Ai 21-6359-02 ○ 2 mm 8.5 cm/3 1/4"
 Ai 21-6359-03 ○ 3 mm 8.5 cm/3 1/4"



Strumpel
 Ai 21-6360-09
 8.5 cm/3 1/4"



Hartamm-Weingartner
 Ai 21-6361-09
 8.5 cm/3 1/4"



HARTMANN
 Ai 21-6361-10 8.5cm



Hartamm
 Ai 21-6362-09
 8.5 cm/3 1/4"



Hartamm-Wullstein
 Ai 21-6363-06 8.5 cm/3 1/4" 08 x 6 mm
 Ai 21-6363-08 8.5 cm/3 1/4" 1.8 x 8 mm



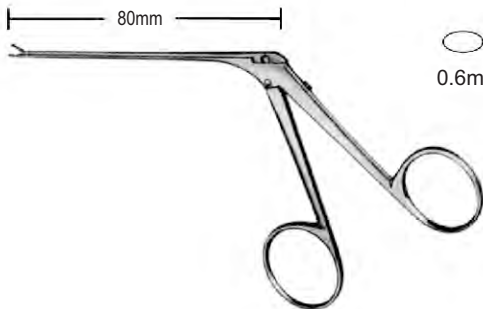
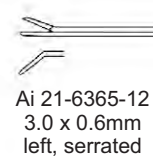
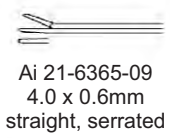
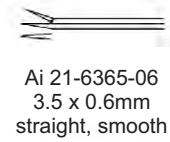
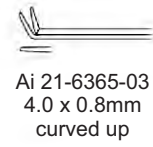
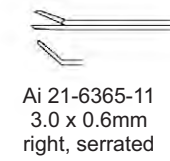
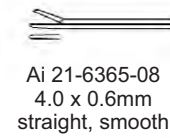
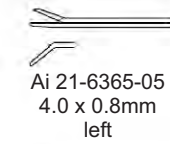
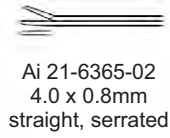
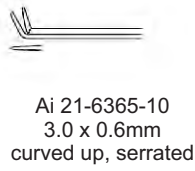
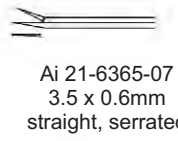
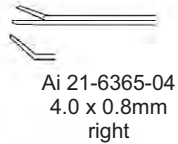
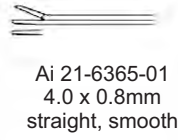
HARTMANN
 Ai 21-6363-09 8.5cm



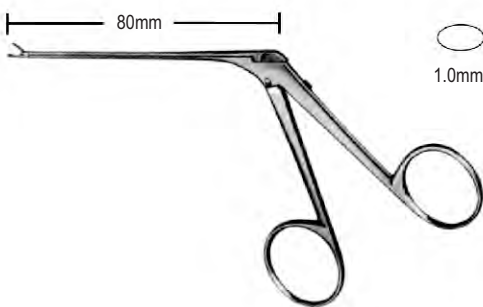
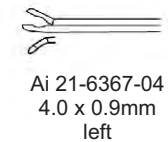
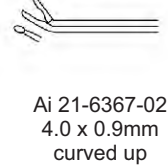
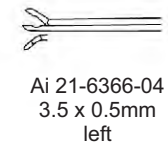
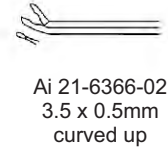
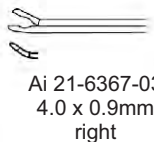
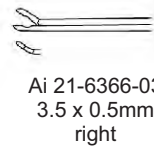
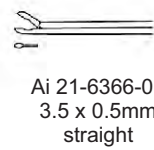
Hartamm-Hoffmann
 Ai 21-6364-01 ○ 1 mm 8.5 cm/3 1/4"
 Ai 21-6364-02 ○ 2 mm 8.5 cm/3 1/4"



MINI McGEE ALLIGATOR



0.6mm

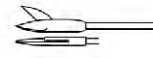


1.0mm

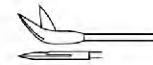




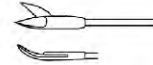
WULLSTEIN



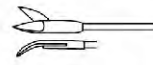
Ai 21-6378-01
 4.0 x 0.8mm
 straight



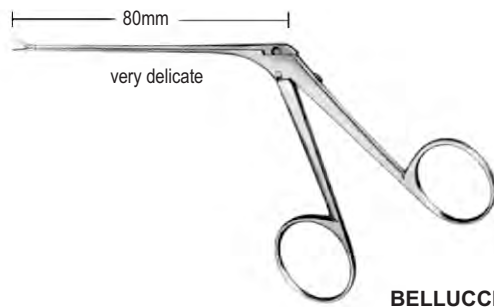
Ai 21-6378-02
 4.0 x 0.8mm
 curved up



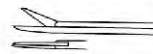
Ai 21-6378-03
 4.0 x 0.8mm
 right



Ai 21-6378-04
 4.0 x 0.8mm
 left



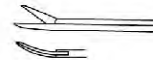
BELLUCCI



Ai 21-6379-01
 4.0 x 1.5mm
 straight



Ai 21-6379-02
 4.0 x 1.5mm
 curved up



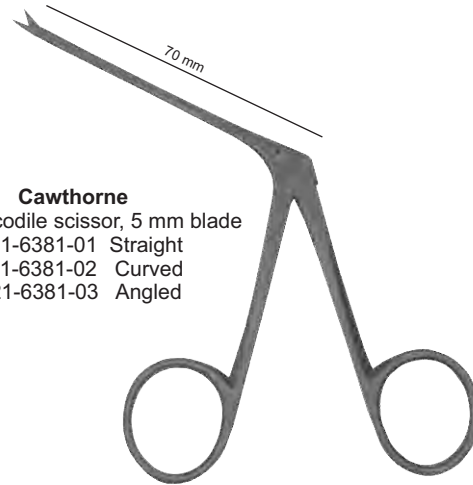
Ai 21-6379-03
 4.0 x 1.5mm
 right



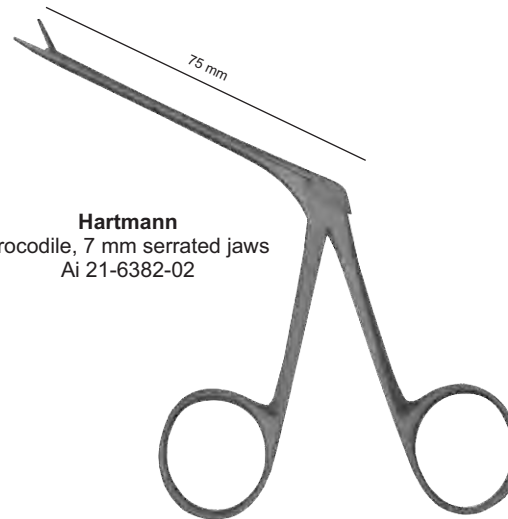
Ai 21-6379-04
 4.0 x 1.5mm
 left



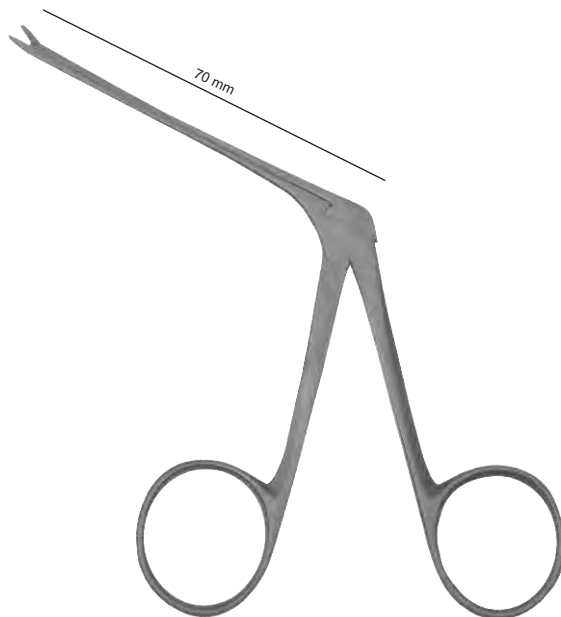
Henckel
 crocodile, scoop blades
 Ai 21-6380-02



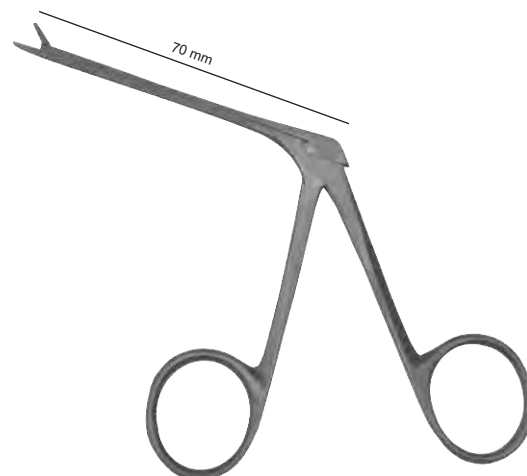
Cawthorne
 micro crocodile scissor, 5 mm blade
 Ai 21-6381-01 Straight
 Ai 21-6381-02 Curved
 Ai 21-6381-03 Angled



Hartmann
 crocodile, 7 mm serrated jaws
 Ai 21-6382-02

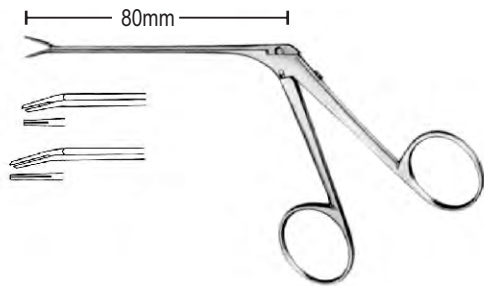


Hartmann
 micro crocodile, 3 mm serrated jaws
 Ai 21-6383-02

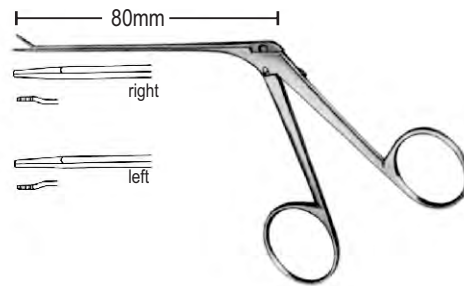


Hough
 medium micro crocodile
 5 mm serrated jaws
 Ai 21-6384-01 Straight
 Ai 21-6384-02 Angled

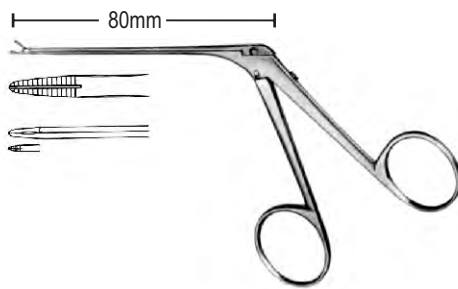




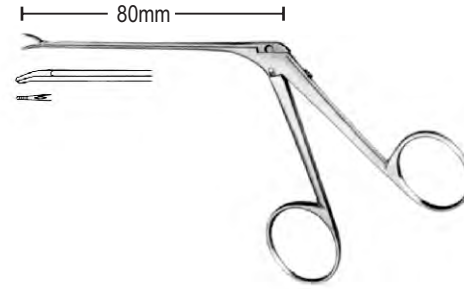
McGEE
 Ai 21-6385-01 0.8 X 3.5mm
 Ai 21-6385-02 0.8 X 6.0mm



JUERS
 Ai 21-6386-01 right
 Ai 21-6386-02 left



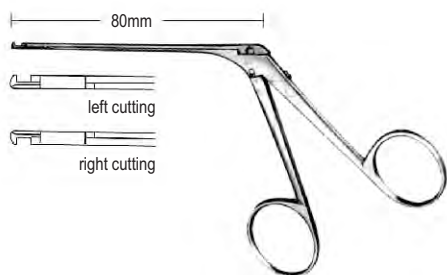
GREVEN
 Ai 21-6387-01



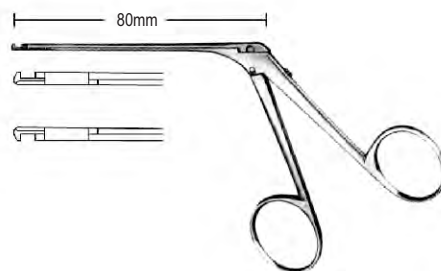
SCHUKNECHT
 Ai 21-6388-01



FULLER
 Ai 21-6389-01

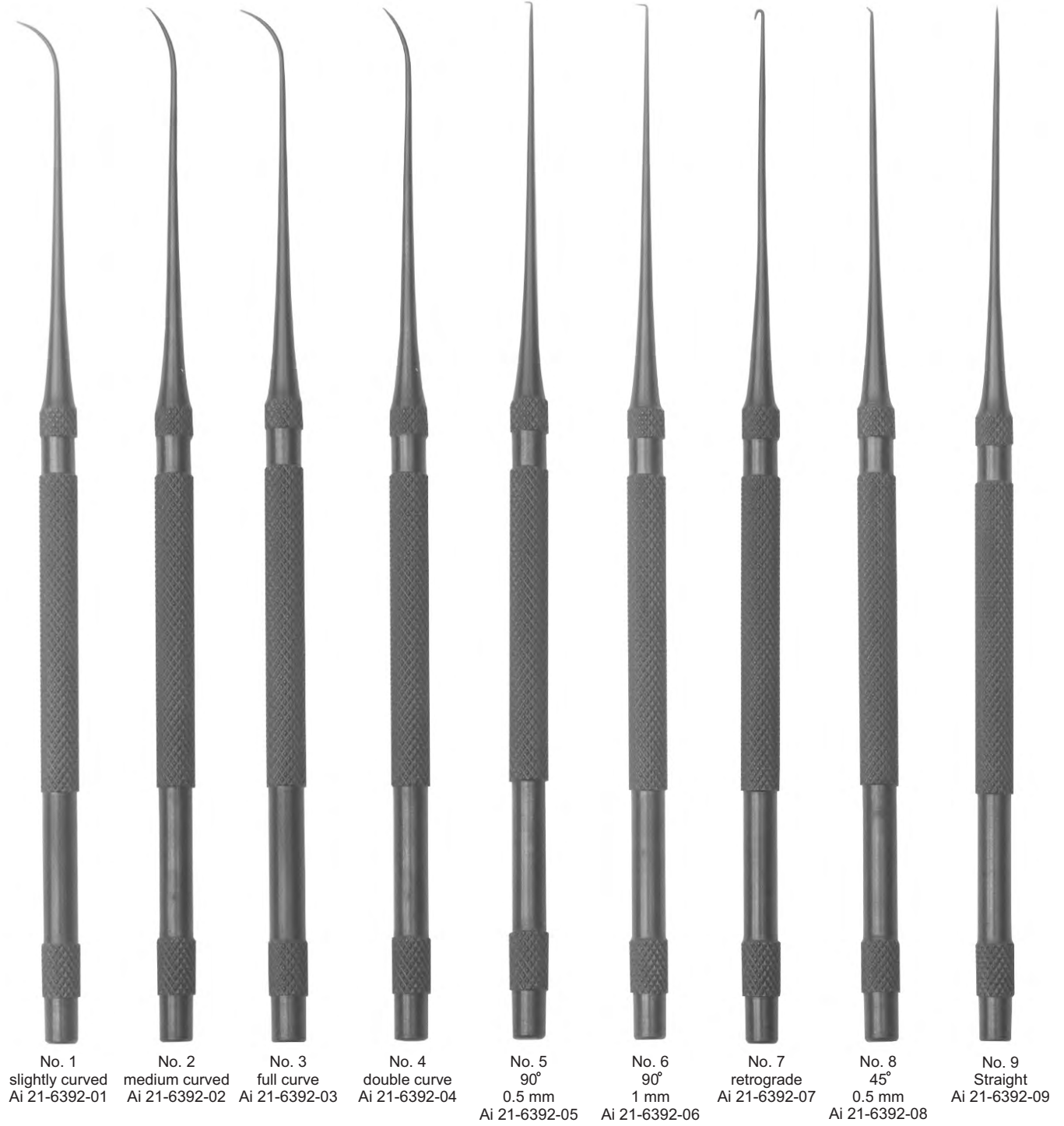


HOUSE-DIETER
 Ai 21-6390-01 left cutting
 Ai 21-6390-02 right cutting



HOUSE-DIETER
 Ai 21-6391-01 down cutting
 Ai 21-6391-02 up cutting

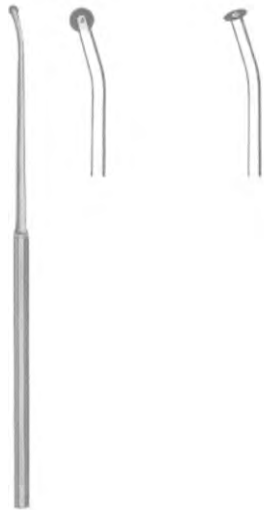




No. 1	No. 2	No. 3	No. 4	No. 5	No. 6	No. 7	No. 8	No. 9
slightly curved	medium curved	full curve	double curve	90°	90°	retrograde	45°	Straight
Ai 21-6392-01	Ai 21-6392-02	Ai 21-6392-03	Ai 21-6392-04	0.5 mm	1 mm	Ai 21-6392-07	0.5 mm	Ai 21-6392-09
				Ai 21-6392-05	Ai 21-6392-06		Ai 21-6392-08	

Cawthorne Stape Hook (Black Finish)
 16.5cm / 6 1/2"
 Ai 21-6392-10 (set of 9)

Messer



Schuknecht
 Ai 21-6393-01

Schuknecht
 Ai 21-6394-02

Schuknecht
 Ai 21-6395-01

Knives



Wullstein
 Ai 21-6396-01



Tabb
 Ai 21-6397-01



Plester
 Ai 21-6398-01



Plester
 Ai 21-6399-02

Ai 21-6400-03



Rosen

Ai 21-6404-20
 2.0 mm



Ai 21-6401-10
 1.0 mm



Ai 21-6402-14
 1.4 mm



Ai 21-6403-16
 1.6 mm



Ai 21-6405-26
 2.6 mm

Ai 21-6406-28
 2.8 mm

Ai 21-6407-30
 3.0 mm



Needles And Hooks



Barbara



Barbara
Ai 21-6408-01



Ai 21-6408-02



Ai 21-6408-03



Rosen
Ai 21-6408-04



25°
Ai 21-6409-03 0.3 mm
Ai 21-6409-06 0.6 mm
Ai 21-6409-10 1.0 mm



45°
Ai 21-6410-03 0.3 mm
Ai 21-6410-06 0.6 mm
Ai 21-6410-10 1.0 mm
Ai 21-6410-12 1.2 mm
Ai 21-6410-15 1.5 mm
Ai 21-6410-20 2.0 mm
Ai 21-6410-25 2.5 mm



90°
Ai 21-6411-03 0.3 mm
Ai 21-6411-06 0.6 mm
Ai 21-6411-10 1.0 mm
Ai 21-6411-12 1.2 mm
Ai 21-6411-15 1.5 mm
Ai 21-6411-20 2.0 mm
Ai 21-6411-25 2.5 mm



Ai 21-6412-05 0.5 mm
Ai 21-6412-10 1.0 mm

Needles And Hooks



90°
 Ai 21-6413-03 0.3 mm
 Ai 21-6413-06 0.6 mm
 Ai 21-6413-10 1.0 mm



90°
 Ai 21-6414-03 0.3 mm
 Ai 21-6414-06 0.6 mm
 Ai 21-6414-10 1.0 mm



McGee
 Ai 21-6415-05 0.5 mm
 Ai 21-6415-10 1.0 mm



McGee
 Ai 21-6416-05 0.5 mm
 Ai 21-6416-10 1.0 mm



0.3 mm Ai 21-6417-03 Ai 21-6418-03 Ai 21-6419-03 Ai 21-6420-03
 0.6 mm Ai 21-6417-06 Ai 21-6418-06 Ai 21-6419-06 Ai 21-6420-06
 1.0 mm Ai 21-6417-10 Ai 21-6418-10 Ai 21-6419-10 Ai 21-6420-10
 Left Right Left Right



Barbara **Rosen**
 Ai 21-6421-01 Ai 21-6421-02



Dissectors, Measuring Road, Elevators, Curettes and Mobilizer



Fisch



Ai 21-6422-01



Ai 21-6422-02



Ai 21-6422-03



Ai 21-6422-04



Rosen

Ai 21-6423-15 1.5 mm
 Ai 21-6423-25 2.5 mm



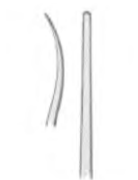
Rosen



Ai 21-6424-01



Ai 21-6424-02



Ai 21-6424-03



Ai 21-6424-04



Ai 21-6424-05



Ai 21-6424-06



House



Ai 21-6425-01
 3.5 mm



Ai 21-6425-02
 4.0 mm



Ai 21-6425-03
 4.5 mm



Ai 21-6425-04
 5.0 mm



Buckingham



Ai 21-6426-01



Ai 21-6426-02



Ai 21-6426-03



St. Bart Blunt Hook
 Ai 21-6427-18
 18 cm / 7"



House
 Ai 21-6428-10 1.0/1.2 mm
 Ai 21-6428-15 1.5/1.8 mm



House
 Ai 21-6429-10 1.0/1.2 mm
 Ai 21-6429-15 1.5/1.8 mm



Shea
 Ai 21-6430-15 1.5 mm



Negus Aspiration
 Ai 21-6431-18
 21 cm / 8 1/4"



Jobson Horne Probe
 one side serrated
 one side ring
 Ai 21-6432-17
 17.5 cm / 7"





BUCK
16.5cm

blunt

	Ai 21-6433-03	Ai 21-6433-02	Ai 21-6433-10	Ai 21-6433-11	Ai 21-6433-12	Ai 21-6433-13	Ai 21-6433-14	Ai 21-6433-15

sharp

	Ai 21-6434-03	Ai 21-6434-02	Ai 21-6434-10	Ai 21-6434-11	Ai 21-6434-12	Ai 21-6434-13	Ai 21-6434-14	Ai 21-6434-15

BUCK
16.5cm

blunt

	Ai 21-6435-03	Ai 21-6435-02	Ai 21-6435-10	Ai 21-6435-11	Ai 21-6435-12	Ai 21-6435-13	Ai 21-6435-14	Ai 21-6435-15

sharp

	Ai 21-6436-03	Ai 21-6436-02	Ai 21-6436-10	Ai 21-6436-11	Ai 21-6436-12	Ai 21-6436-13	Ai 21-6436-14	Ai 21-6436-15



Width of Bite

Citelli
 Ai 21-6437-20 2.0 mm
 Ai 21-6437-30 3.0 mm



Width of Bite





Citelli-Beyer
 Ai 21-6438-15 1.5 mm
 Ai 21-6438-20 2.0 mm



Width of Bite



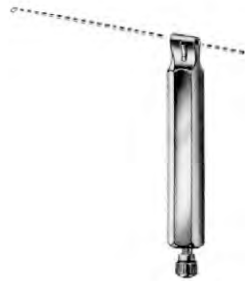
Brunings
 Ai 21-6439-40
 Ai 21-6439-60

-  Ai 21-6440-30 3.0 mm
-  Ai 21-6440-40 4.0 mm
-  Ai 21-6440-50 5.0 mm
-  Ai 21-6440-60 6.0 mm



Kerrison
 20 cm/8"





Ai 21-6441-10



Ai 21-6442-15



Ai 21-6443-01
7.0cm



Ai 21-6443-02
7.0cm



Ai 21-6443-03
7.0cm



Ai 21-6443-04
7.0cm



Ai 21-6443-05
7.0cm



Ai 21-6443-06
7.0cm



Ai 21-6443-07
7.0cm



LEMPERT
19.0cm



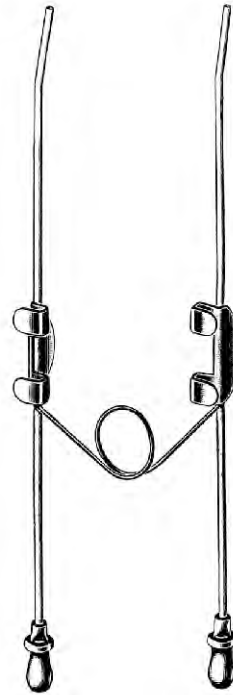
Ai 21-6444-02
2mm



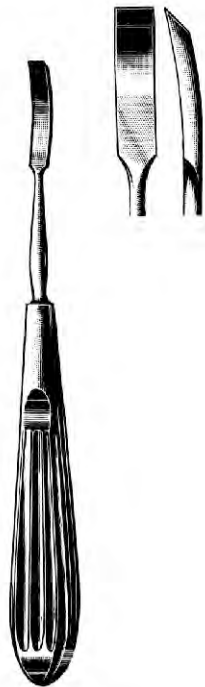
Ai 21-6445-02
2mm



Ai 21-6445-03
3mm



SHAMBAUGH
 Ai 21-6446-19 19.5cm Ai 21-6447-19
 left tube 2.0mm Ø right tube 2.0mm Ø
 right tube 2.5mm Ø left tube 2.5mm Ø



LEMPERT
Ai 21-6448-18
18.0cm



LEMPERT
Ai 21-6449-20
20.5cm





LANGENBECK
 Ai 21-6450-13
 13.0cm



SHAPLEIGH
 13.0cm



Ai 21-6451-01



Ai 21-6451-02



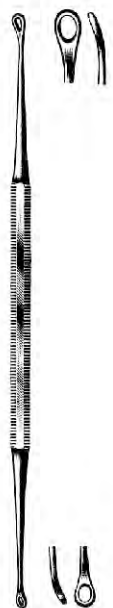
Ai 21-6451-03



Ai 21-6451-04



COXETER
 Ai 21-6452-15
 15.0cm
 blunt



Ai 21-6453-17 17.0cm blunt
 Ai 21-6453-18 17.0cm sharp



JANSSEN
 Ai 21-6454-15
 15.0cm
 sharp



BARTH
 Ai 21-6455-18
 18.0cm
 sharp



GROSS
 Ai 21-6456-12
 12.0cm, blunt



GROSS
 Ai 21-6457-12
 12.0cm
 blunt - sharp



GROSS
 Ai 21-6458-12
 12.0cm
 blunt



GROSS
 Ai 21-6459-12
 12.0cm
 blunt



GROSS
 Ai 21-6460-12
 12.0cm
 blunt - sharp



Ai 21-6461-01



Ai 21-6461-02



Ai 21-6462-01



Ai 21-6462-02



Ai 21-6462-03

BILLEAU
 16.5cm



MOLDENHAUER
 Ai 21-6463-16
 16.5cm



ZAUFAL
 Ai 21-6464-16
 16.0cm



HARTMANN
 Ai 21-6465-16
 16.0cm



BARKER
 Ai 21-6466-17
 17.0cm





ALLPORT
 Ai 21-6467-16
 16.0cm



DAY
 16.0cm



Ai 21-6468-01 Ai 21-6468-02



LUCAE
 14.0cm



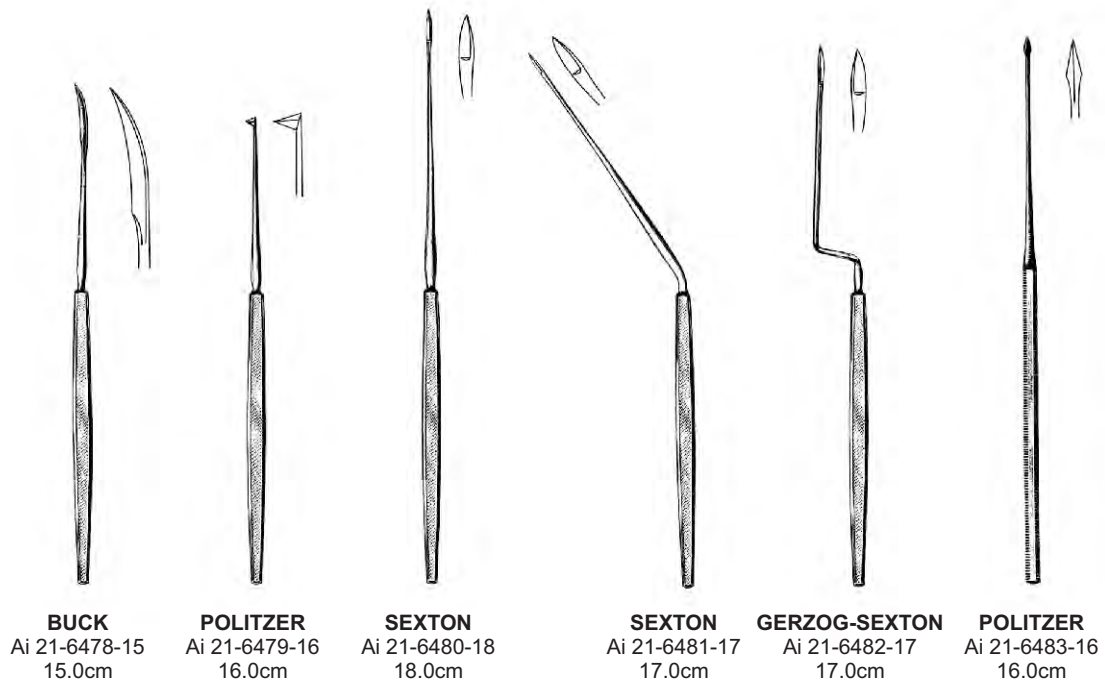
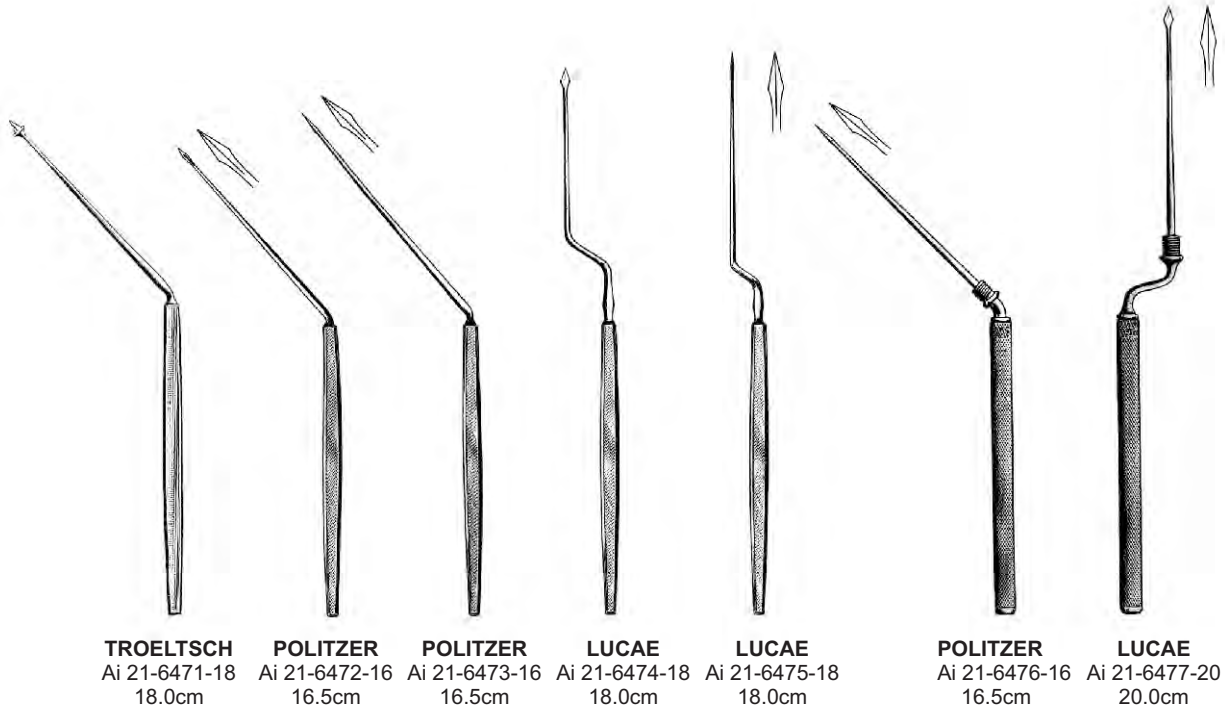
Ai 21-6469-01 Ai 21-6469-02 Ai 21-6469-03



WAGENER
 14.0cm

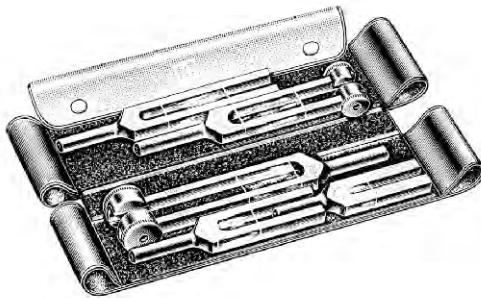


Ai 21-6470-01 Ai 21-6470-02 Ai 21-6470-03 Ai 21-6470-04 Ai 21-6470-05 Ai 21-6470-06 Ai 21-6470-07

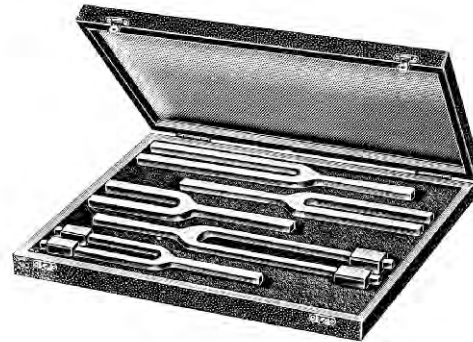




HARTMANN-OSTMANN
 Ai 21-6484.00
 set of 8 tuning forks



Ai 21-6485-00
 set of 5 alloy tuning forks



HARTMANN
 Ai 21-6486-00 Ai 21-6487-00
 set of 5 tuning forks set of 6 tuning forks

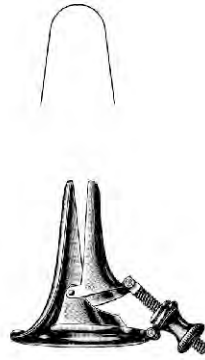
EN Rhinology

DE Rhinologie

ES Rinología

Page 541 to 574





VACHER
 Ai 22-6601-00



VOLTOLINI



Ai 22-6602-01



Ai 22-6602-02



Ai 22-6602-03



GOLDSMITH (Thudichum) Ai 22-6603-04
 Ai 22-6603-00 set / 7



Fig. 1

Ai 22-6603-01



Fig. 2

Ai 22-6603-02



Fig. 3

Ai 22-6603-03



Fig. 4



Fig. 5

Ai 22-6603-05

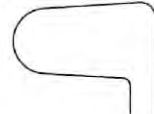


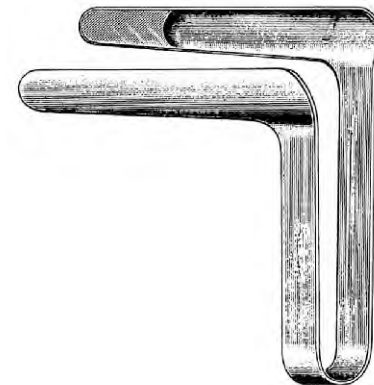
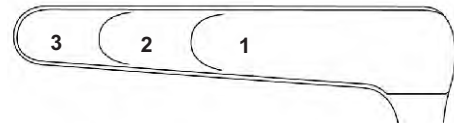
Fig. 6

Ai 22-6603-06

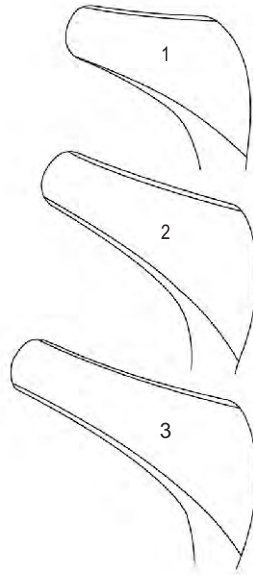


Fig. 7

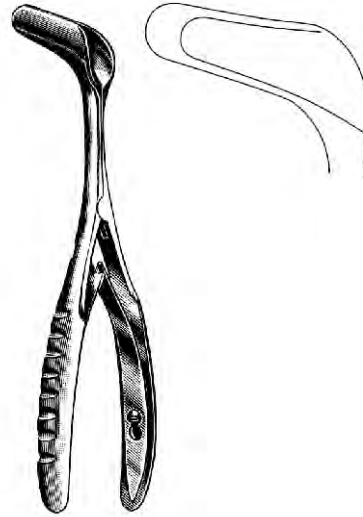
Ai 22-6603-07



ST. CLAIR THOMSON
 Ai 22-6604-00 set / 3
 Ai 22-6604-01 35mm Fig. 1
 Ai 22-6604-02 50mm Fig. 2
 Ai 22-6604-03 75mm Fig. 3



HARTMANN-HALLE
 15.0cm
 Ai 22-6605-01 Fig. 1
 Ai 22-6605-02 Fig. 2
 Ai 22-6605-03 Fig. 3



SCHWARZ
 Ai 22-6606-14
 14.0cm



VIENNA
 14.5cm
 Ai 22-6607-01 (infant)
 Ai 22-6607-02 (child)
 Ai 22-6607-03 (adult)
 Ai 22-6607-04 (sheet metal)



MOD WIEN
 Ai 22-6608-14
 14.5cm





Ai 22-6609-13
13.0cm



Ai 22-6610-13
13.0cm



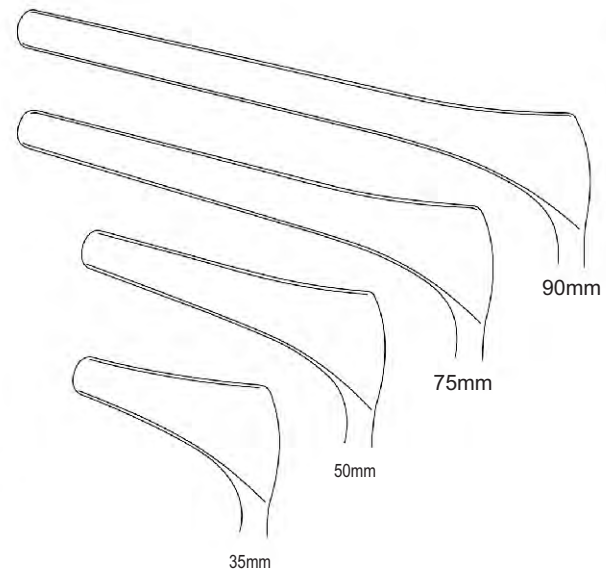
TIECK-HALLE
13.5cm
Ai 22-6611-01
Ai 22-6611-02



TIECK-HALLE
13.5cm
Ai 22-6612-13



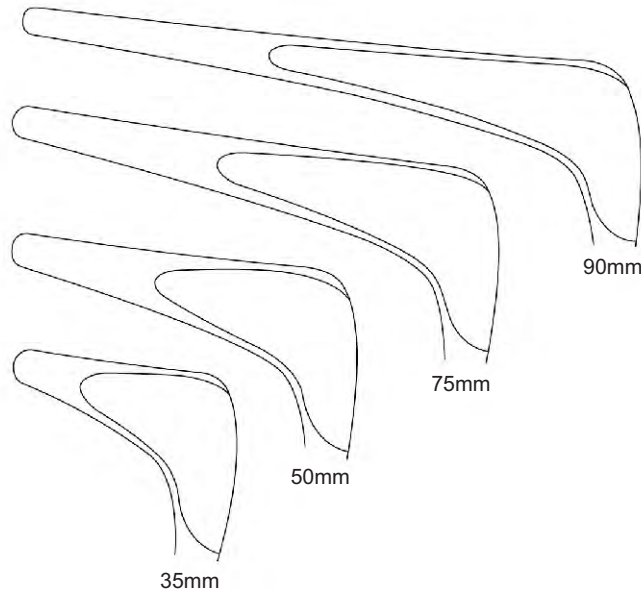
KILLIAN
13.0cm
Ai 22-6613-35
Ai 22-6613-50
Ai 22-6613-75
Ai 22-6613-90



KILLIAN (with side screw)
13.0cm
Ai 22-6614-35
Ai 22-6614-50
Ai 22-6614-75
Ai 22-6614-90



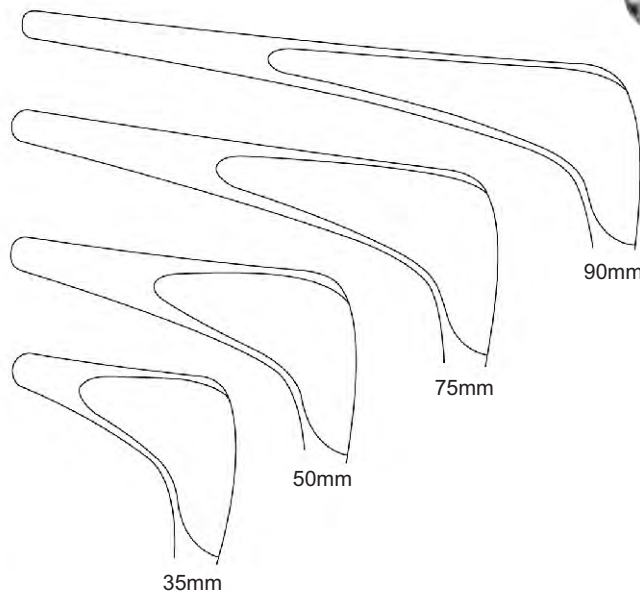
COTTLE
 15.0cm
 Ai 22-6615-35
 Ai 22-6615-50
 Ai 22-6615-75
 Ai 22-6615-90



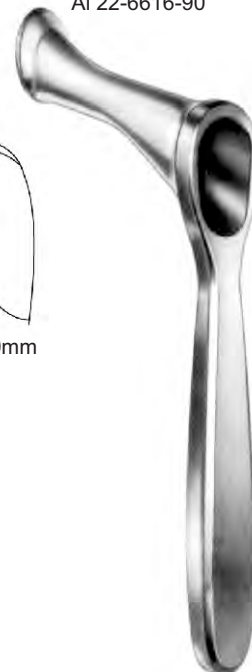
COTTLE (with side screw)
 15.0cm
 Ai 22-6616-35
 Ai 22-6616-50
 Ai 22-6616-75
 Ai 22-6616-90



COTTLE
 (dull black chromium plated)
 14.0cm

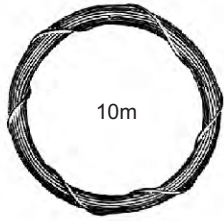


Ai 22-6617-35
 Ai 22-6617-50
 Ai 22-6617-75
 Ai 22-6617-90



YANKAUER
 Ai 22-6618-19
 19.0cm





10m

Ai 22-6619-03 0.3mm Ø
Ai 22-6619-04 0.4mm Ø

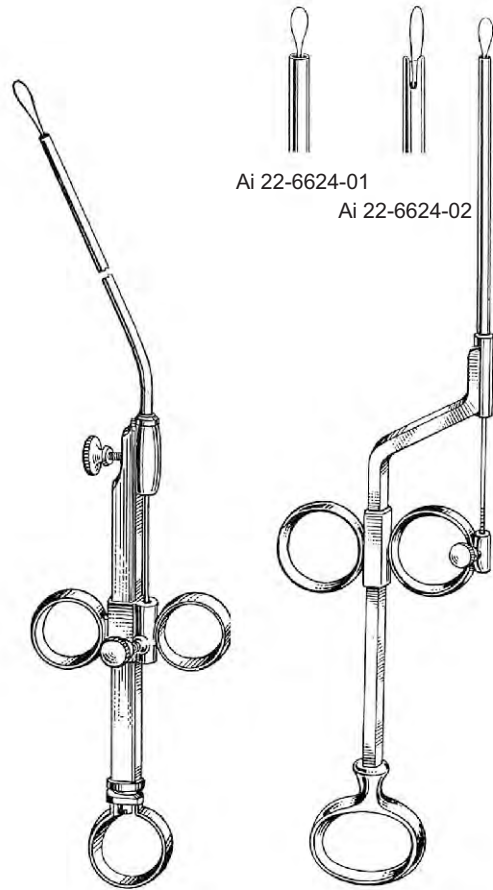


Ai 22-6620-02 0.2mm Ø
Ai 22-6620-03 0.3mm Ø



KRAUSE
Ai 22-6621-26
26.0cm

KRAUSE-VOSS
Ai 22-6622-26
26.0cm



Ai 22-6624-01
Ai 22-6624-02

KRAUSE
Ai 22-6623-00

GLEGG



KILLIAN
 Ai 22-6625-17
 17.0cm



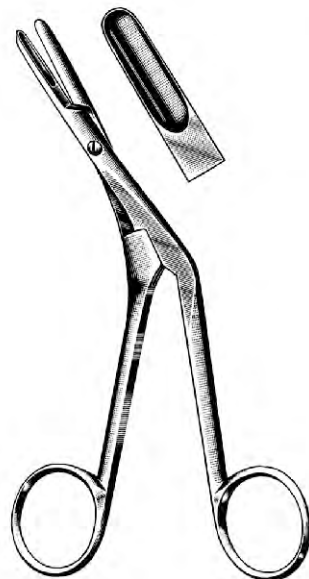
LITTAUER
 Ai 22-6626-18
 18.0cm



HARTMANN
 Ai 22-6627-20
 20.0cm



QUIRE
 Ai 22-6628-12
 12.0cm



GRAIG
 Ai 22-6629-18
 18.0cm



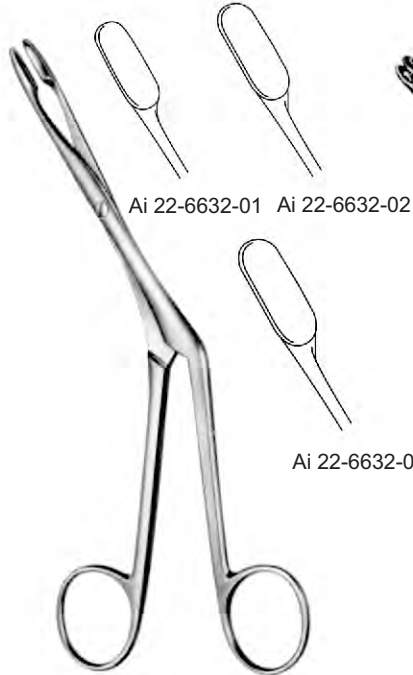
Ai 22-6630-01 Ai 22-6630-02

18.0cm





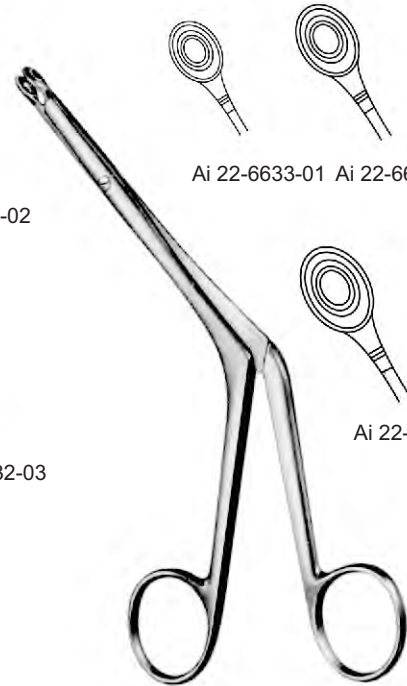
KNIGHT
 Ai 22-6631-18
 18.0cm



Ai 22-6632-01 Ai 22-6632-02

Ai 22-6632-03

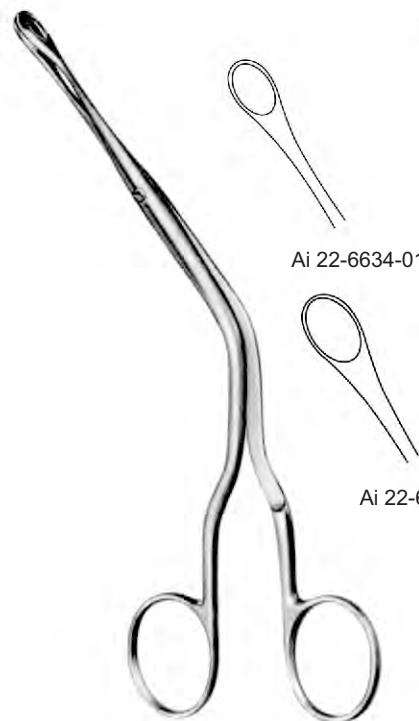
HEYMANN
 18.0cm



Ai 22-6633-01 Ai 22-6633-02

Ai 22-6633-03 Ai 22-6633-04

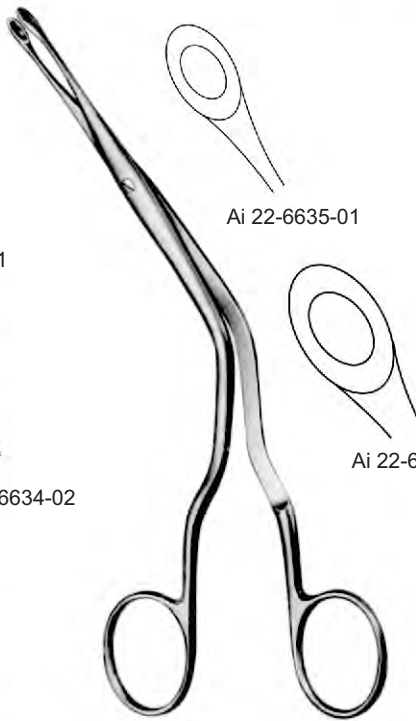
BRUENINGS
 19.0cm



Ai 22-6634-01

Ai 22-6634-02

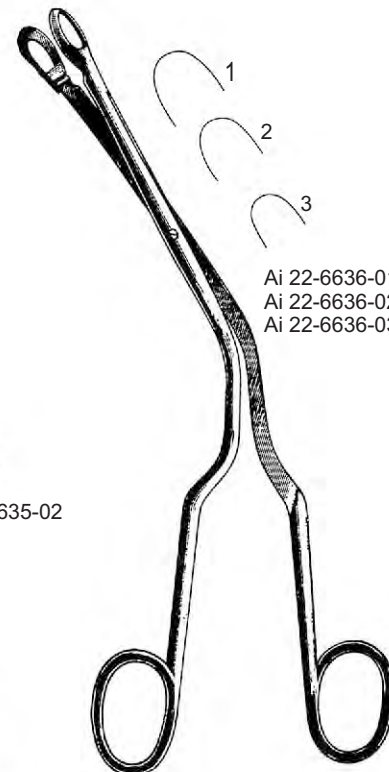
LUC
 20.0cm



Ai 22-6635-01

Ai 22-6635-02

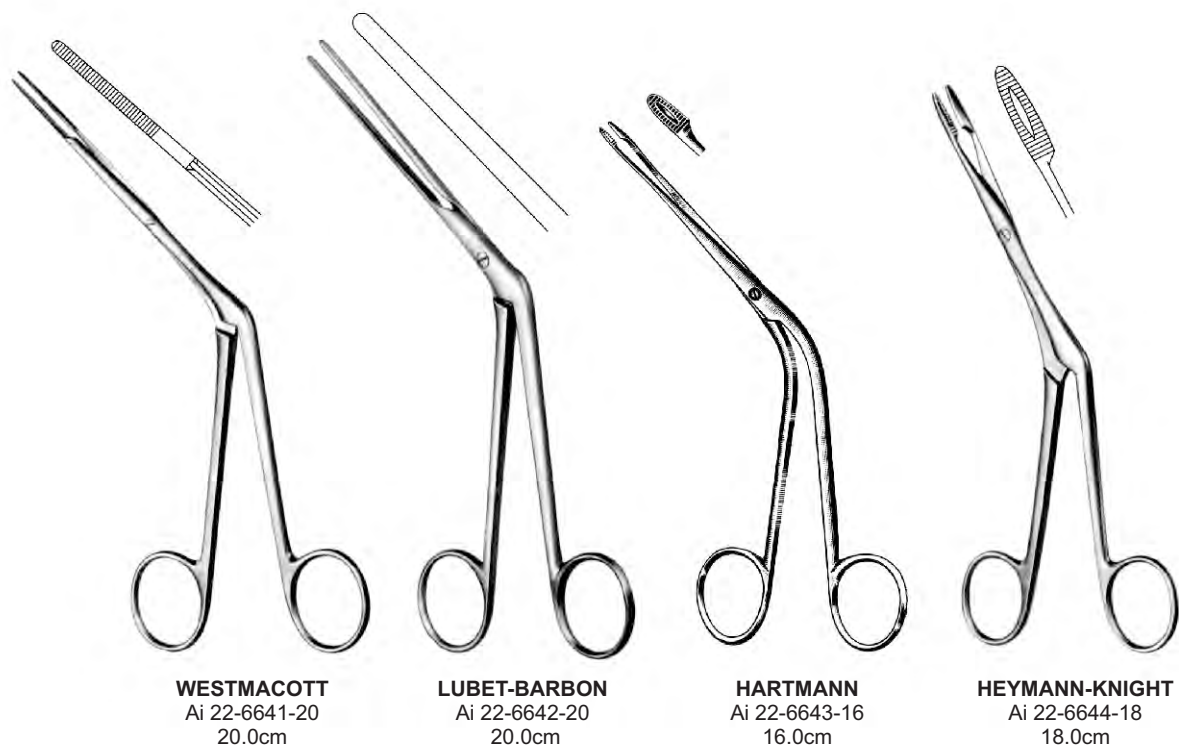
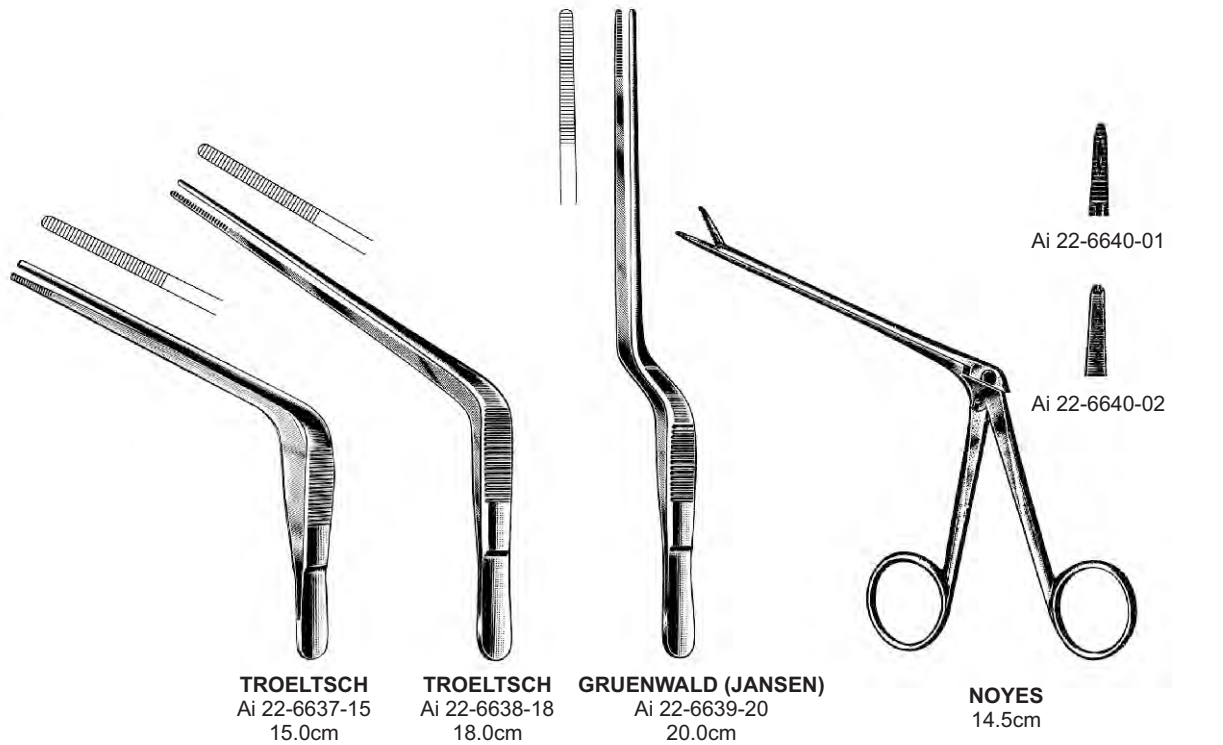
LUC
 20.0cm

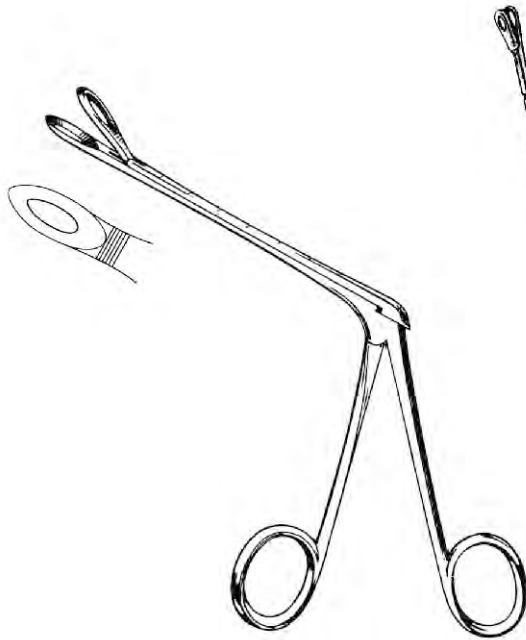


Ai 22-6636-01 Fig. 1
 Ai 22-6636-02 Fig. 2
 Ai 22-6636-03 Fig. 3

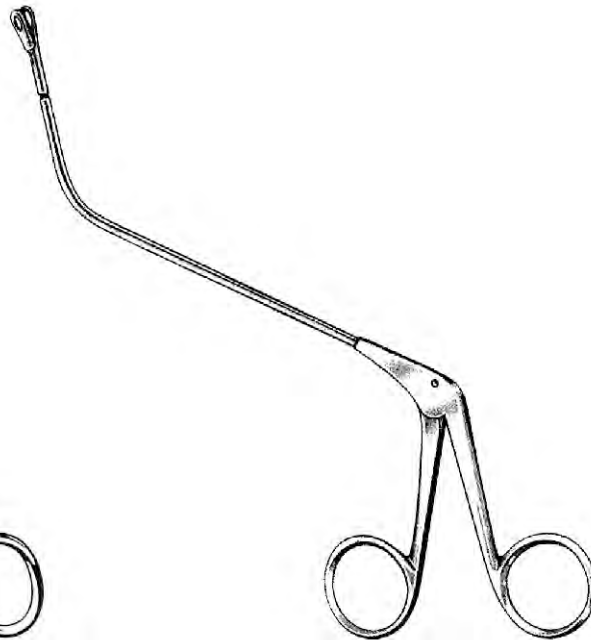
LUC
 20.0cm







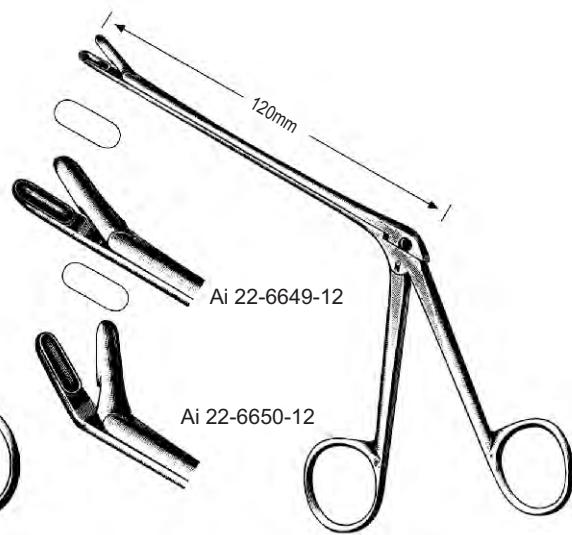
HENCKEL
 Ai 22-6645-20
 20.0cm



JATHO
 Ai 22-6646-15



WATSON-WILLIAMS
 Ai 22-6648-19
 19.0cm



TAKAHASHI
 19.0cm

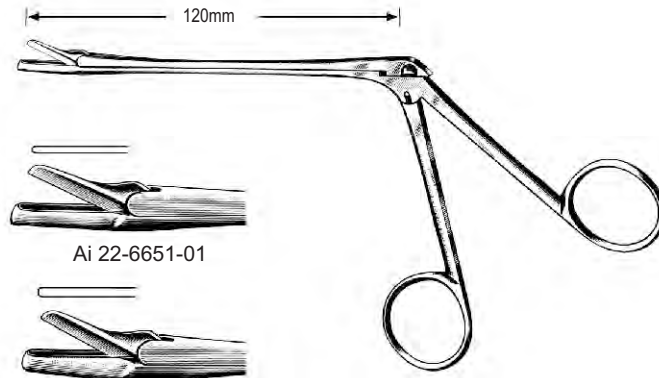
WEIL
 Ai 22-6647-12

Ai 22-6648-12

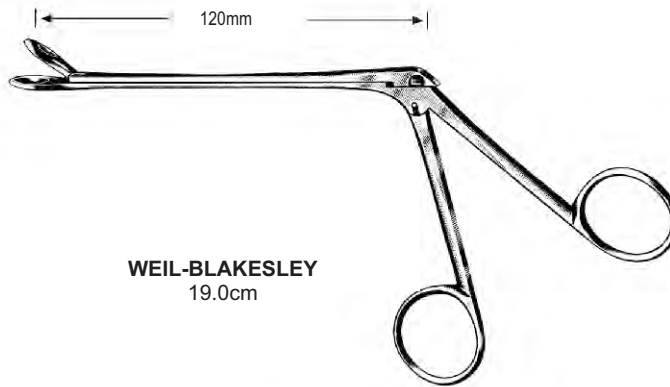
Ai 22-6649-12

Ai 22-6650-12

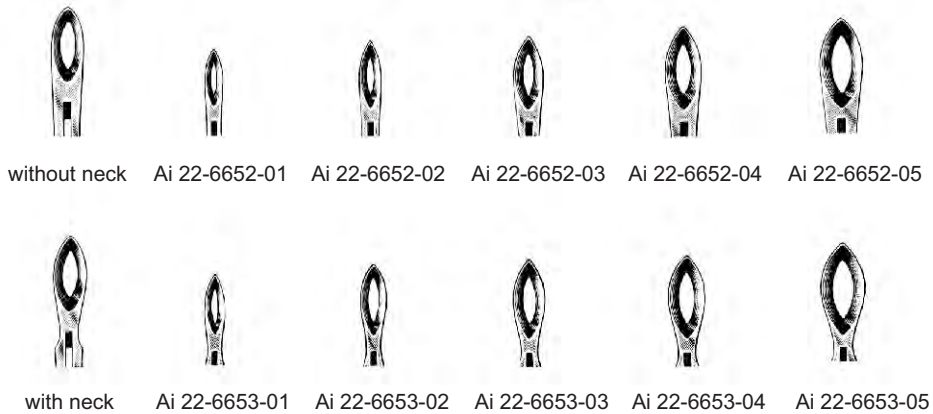


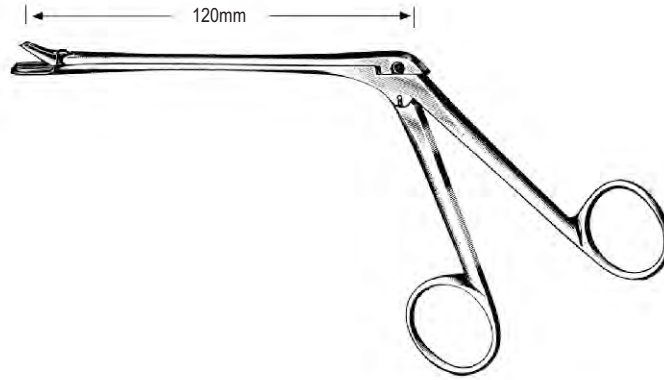


STRUYCKEN
19.0cm

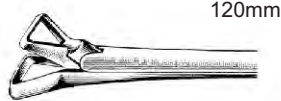


WEIL-BLAKESLEY
19.0cm





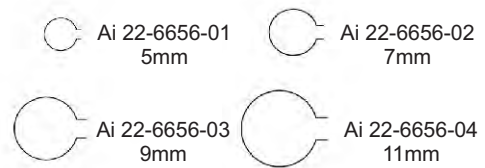
HAJEK
19.0cm



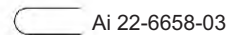
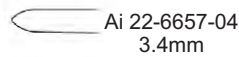
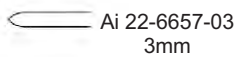
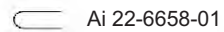
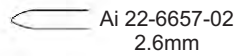
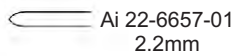
SCHMEDEN
19.0cm

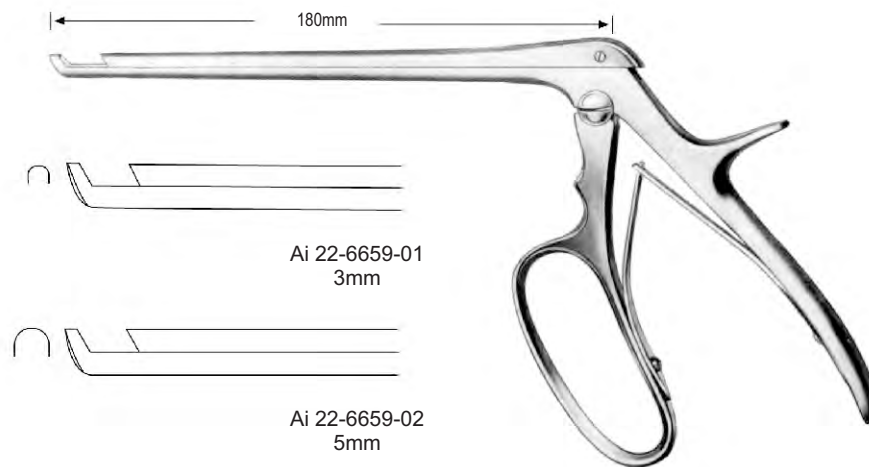


HARTMANN
19.0cm

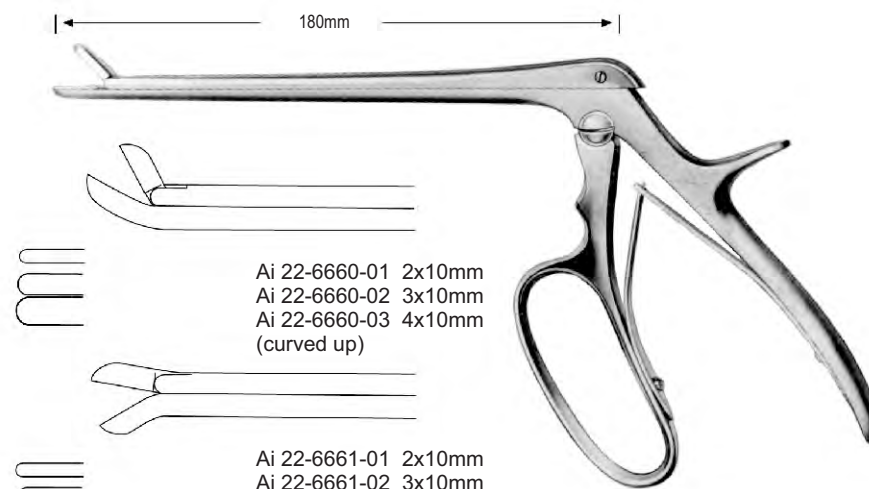


MYLES
19.0 cm

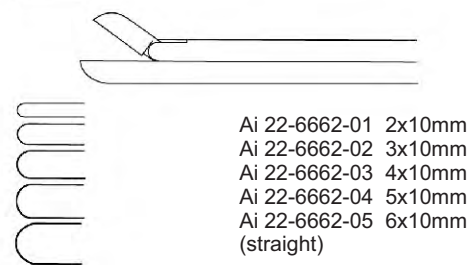


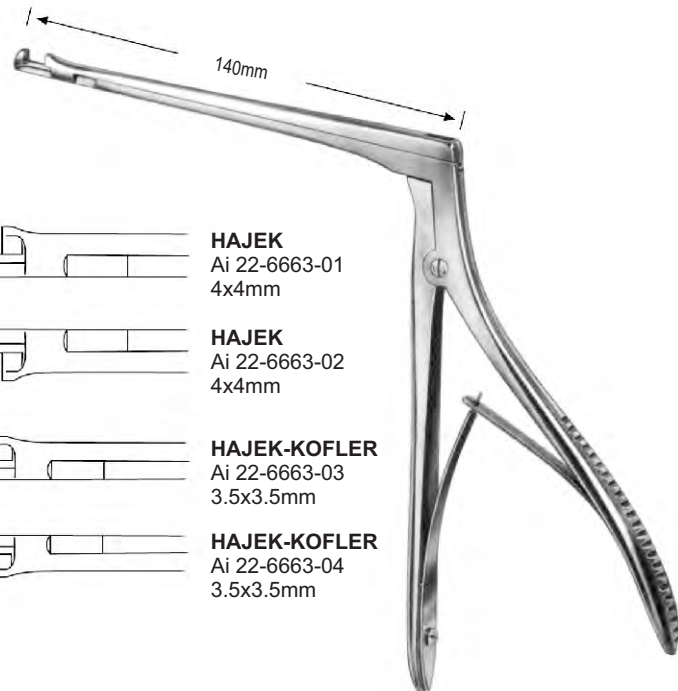


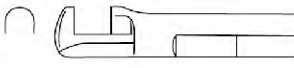

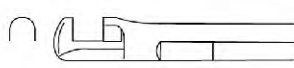
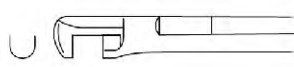
**FERRIS-SMITH-KERRISON
 (CLOWARD HARPER)**

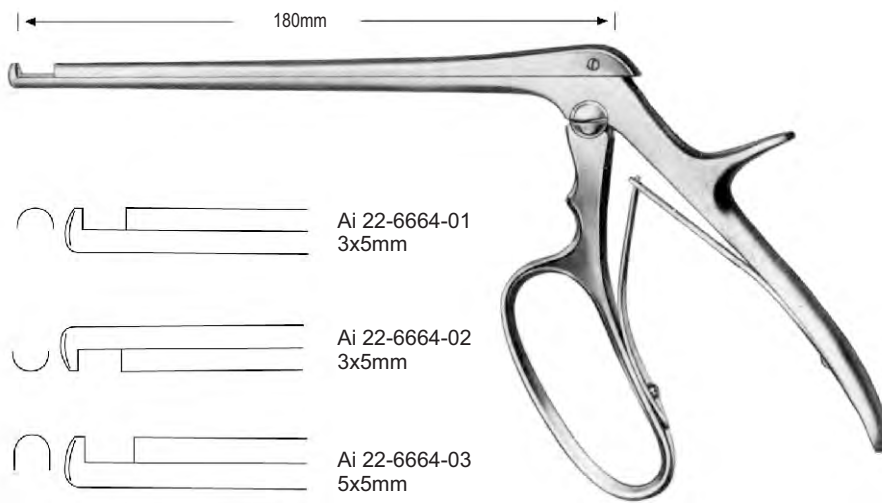


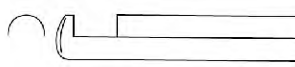
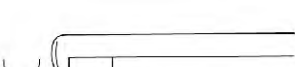


FERRIS-SMITH-CUSHING





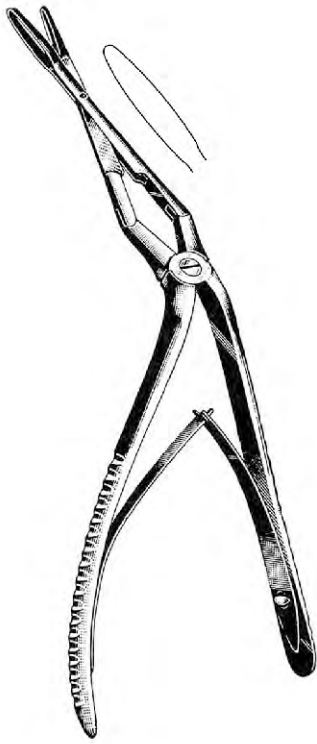
-  **HAJEK**
Ai 22-6663-01
4x4mm
-  **HAJEK**
Ai 22-6663-02
4x4mm
-  **HAJEK-KOFLER**
Ai 22-6663-03
3.5x3.5mm
-  **HAJEK-KOFLER**
Ai 22-6663-04
3.5x3.5mm



-  Ai 22-6664-01
3x5mm
-  Ai 22-6664-02
3x5mm
-  Ai 22-6664-03
5x5mm
-  Ai 22-6664-04
5x5mm

FERRIS-SMITH-KERRISON





JANSEN-STRUYCKEN
 Ai 22-6670-19
 19.0cm



MIDDLETON-JANSEN
 Ai 22-6671-19
 19.0cm



MIDDLETON-JANSEN
 Ai 22-6672-19
 19.0cm



CAPLAN
 Ai 22-6673-20
 20.0cm

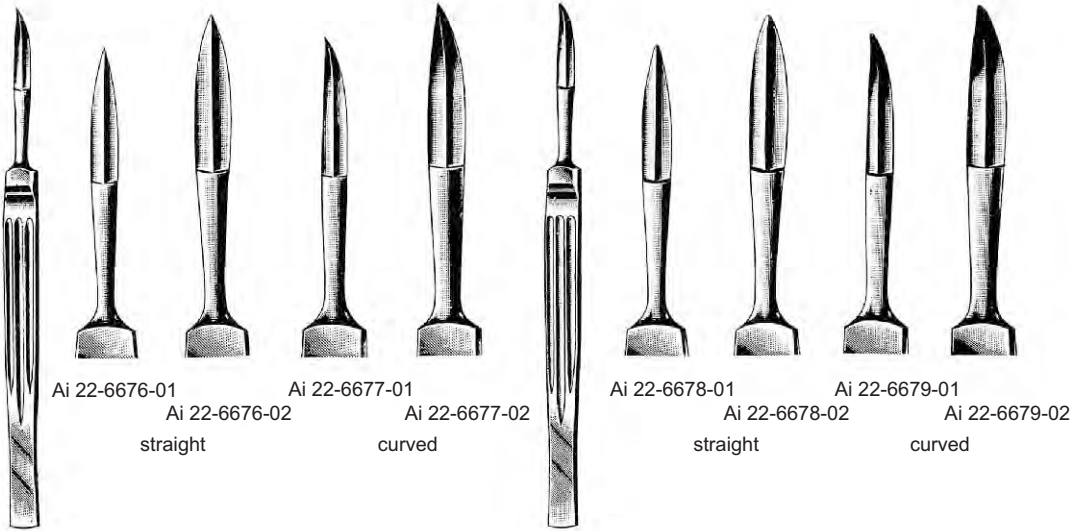


KILLIAN
 Ai 22-6674-21
 21.0cm



RUBIN
 Ai 22-6675-21
 21.0cm



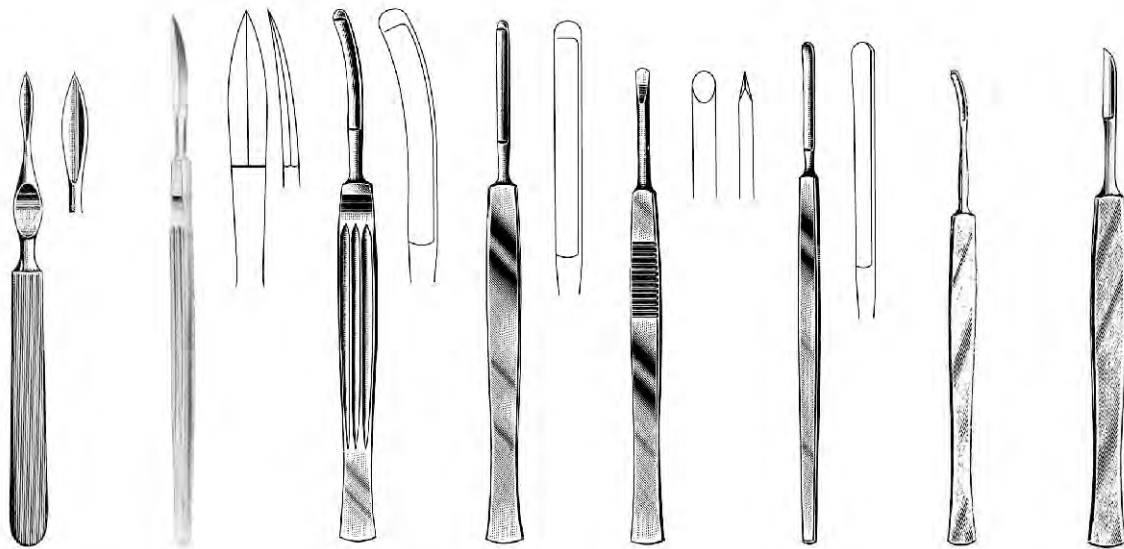


Ai 22-6676-01
 Ai 22-6676-02 straight
 Ai 22-6677-01
 Ai 22-6677-02 curved

Ai 22-6678-01
 Ai 22-6678-02 straight
 Ai 22-6679-01
 Ai 22-6679-02 curved

JOSEPH (sharp)
 15.0cm

JOSEPH (blunt)
 15.0cm

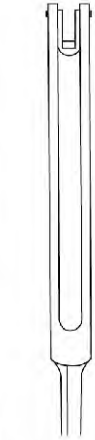


BALLENGER Ai 22-6680-00
FOMON Ai 22-6681-16 16.0cm
CONVERSE Ai 22-6682-16 16.0cm
JOSEPH Ai 22-6683-15 15.0cm
COTTLE Ai 22-6684-15 15.0cm
COTTLE Ai 22-6685-15 15.0cm
HEYMANN Ai 22-6686-00
KRIEG Ai 22-6687-00

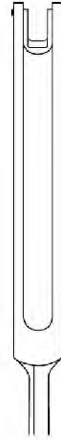




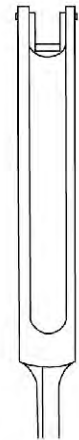
BALLENGER
20.0cm



Ai 22-6688-03
3mm



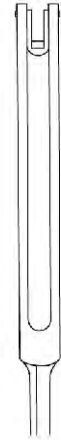
Ai 22-6688-04
4mm



Ai 22-6688-05
5mm



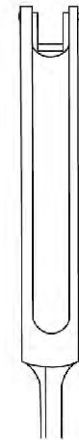
BALLENGER
20.0cm



Ai 22-6689-03
3mm



Ai 22-6689-04
4mm



Ai 22-6689-05
5mm



BRUENINGS
Ai 22-6690-16
16.5cm



FREER
Ai 22-6691-00



FREER
Ai 22-6692-15
15.0cm



FREER
Ai 22-6693-19
19.0cm



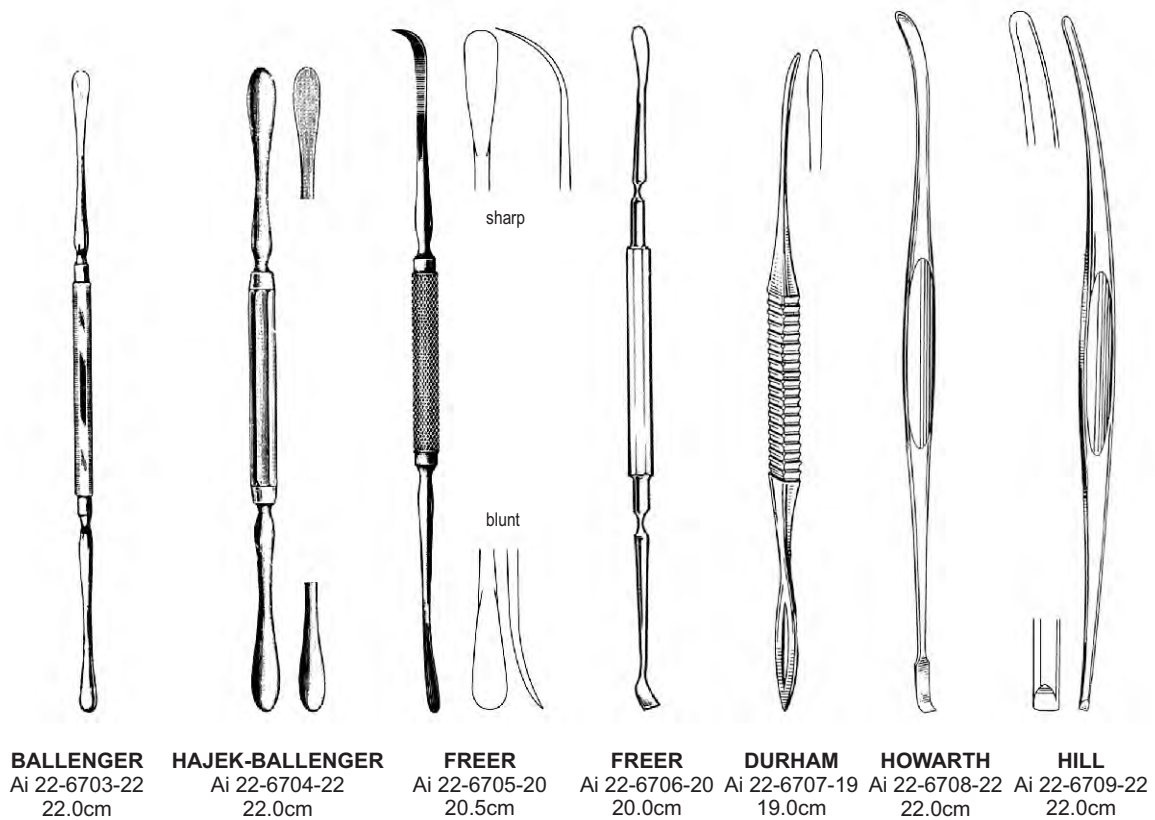
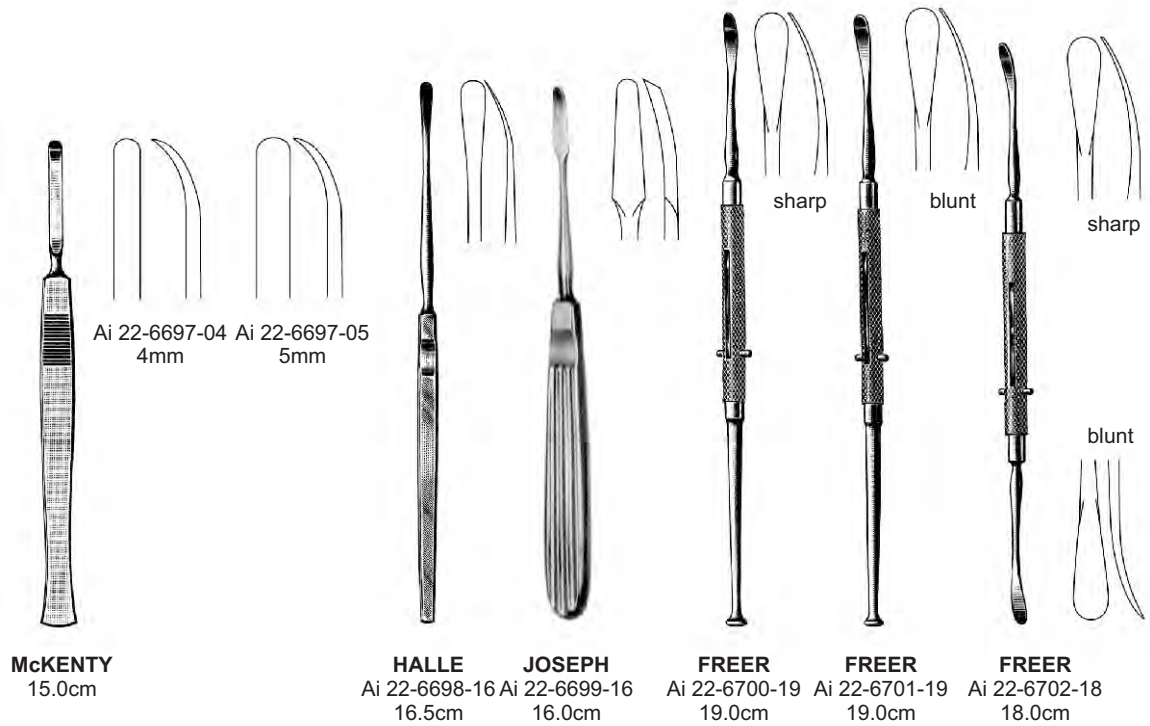
FREER
Ai 22-6694-19
19.0cm

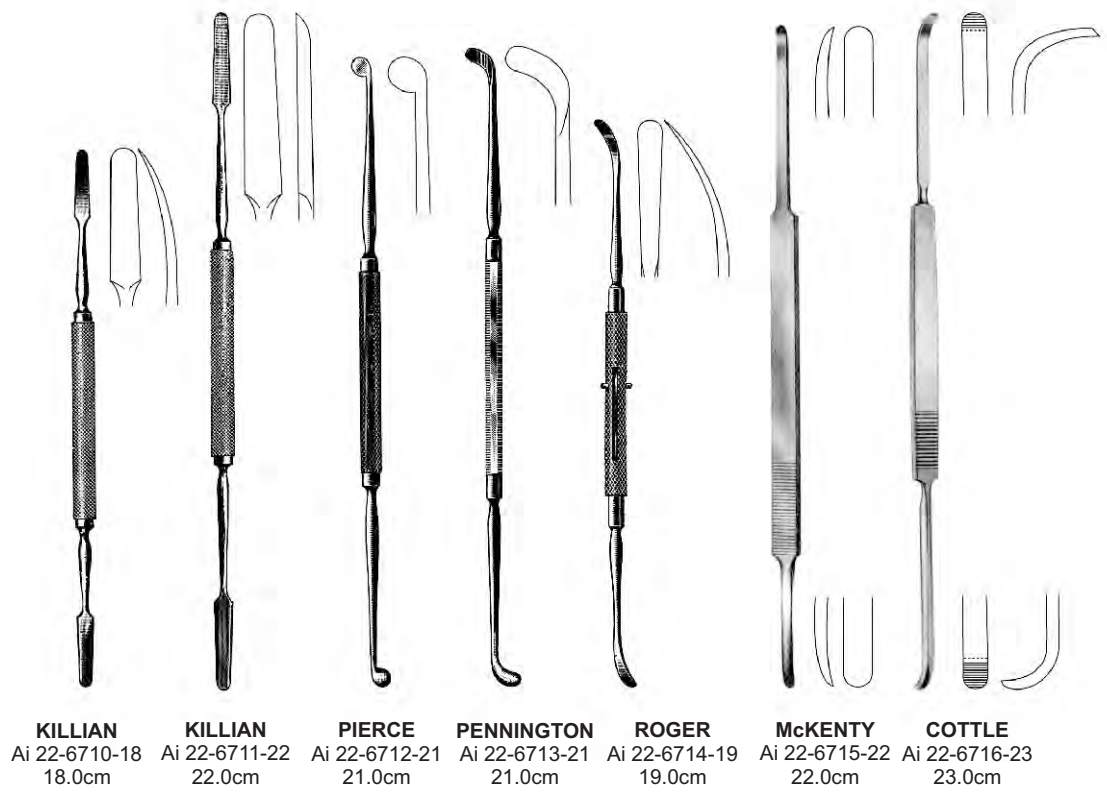


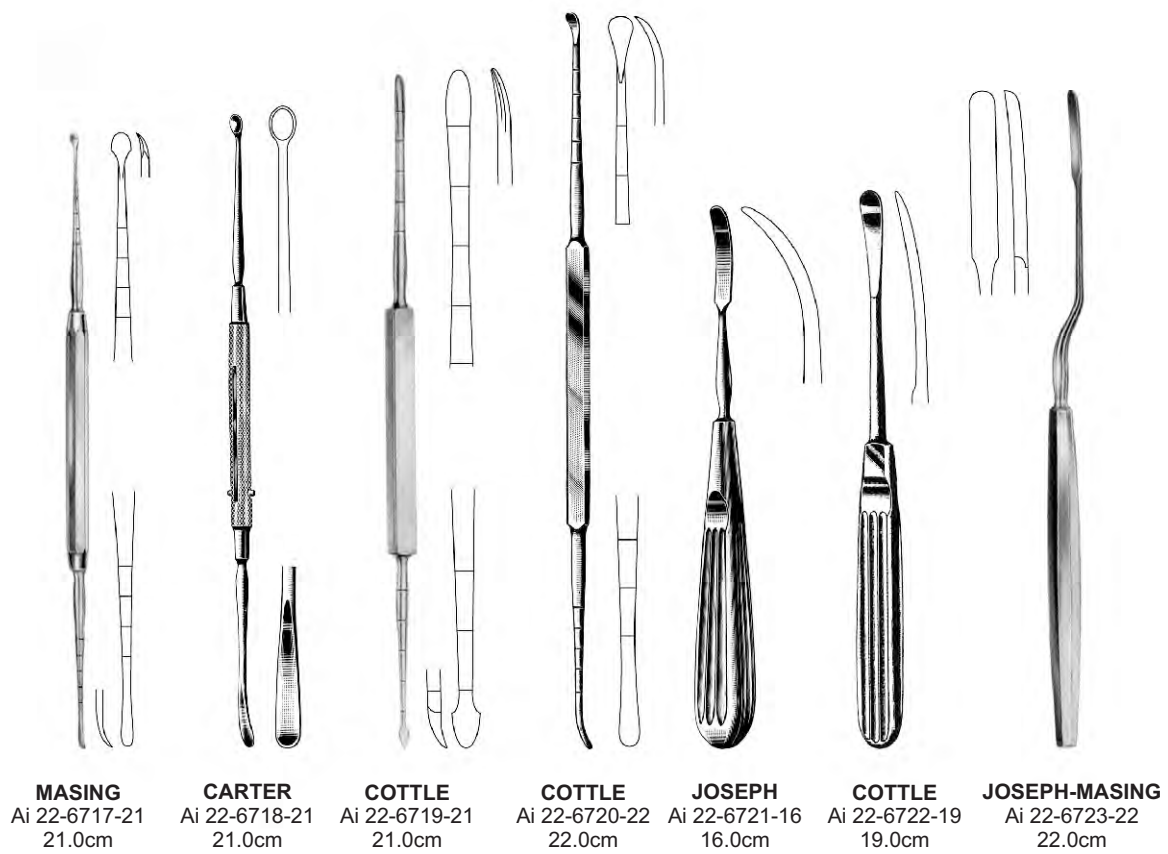
FREER
Ai 22-6695-19
19.0cm



FREER
Ai 22-6696-19
19.0cm

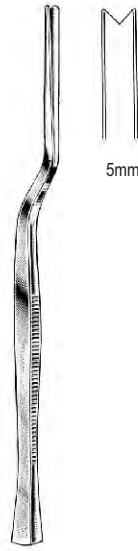








KILLIAN
 Ai 22-6724-17
 17.0cm



KILLIAN-CLAUS
 Ai 22-6725-17
 17.0cm



M
 Ai 22-6726-04
 4mm



Ai 22-6726-06
 6mm



Ai 22-6726-08
 8mm



FREER
 Ai 22-6727-15
 15.0cm



WEST
 Ai 22-6728-16
 16.0cm



WEST
 Ai 22-6729-16
 16.0cm



FREER
 Ai 22-6730-16



FREER
 Ai 22-6731-16



FREER



Ai 22-6732-19
 4mm



Ai 22-6733-19
 4mm

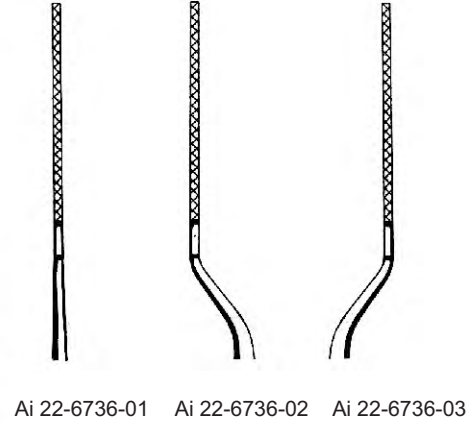


Ai 22-6734-17

Ai 22-6735-17

JOSEPH
17.0cm

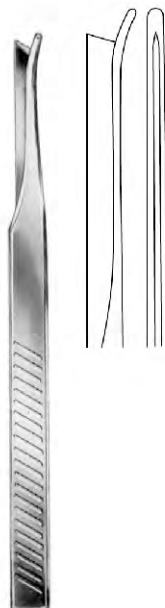
JOSEPH
19.0cm



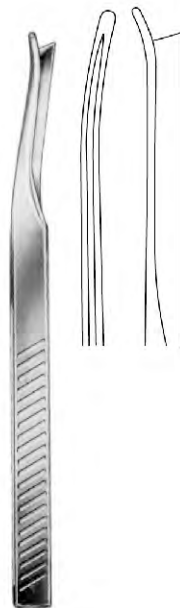
Ai 22-6736-01

Ai 22-6736-02

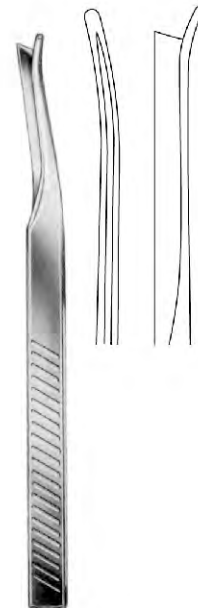
Ai 22-6736-03



SILVER
Ai 22-6737-18
18.0cm

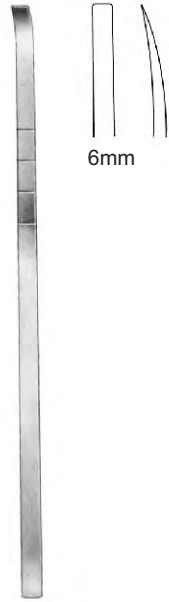


SILVER
Ai 22-6738-18
18.0cm

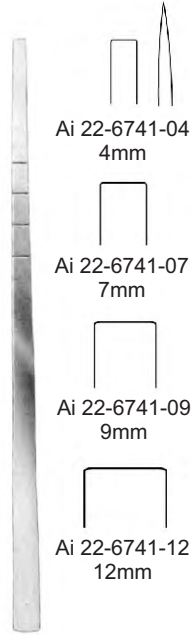


SILVER
Ai 22-6739-18
18.0cm





COTTLE
 Ai 22-6740-18
 18.0cm



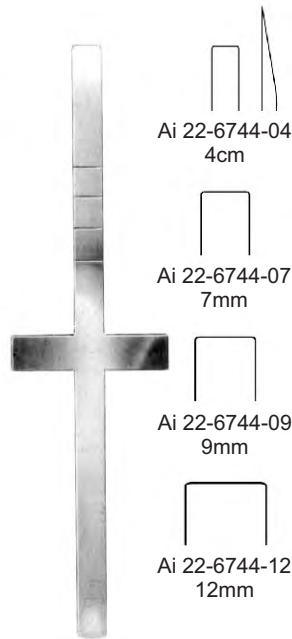
COTTLE
 18.0cm



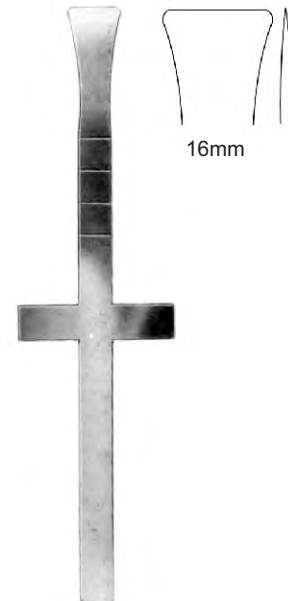
COTTLE
 Ai 22-6742-18
 18.0cm



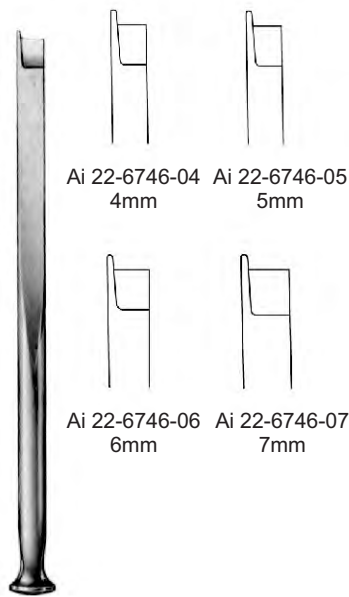
COTTLE
 Ai 22-6743-18
 18.0cm



COTTLE
 18.0cm

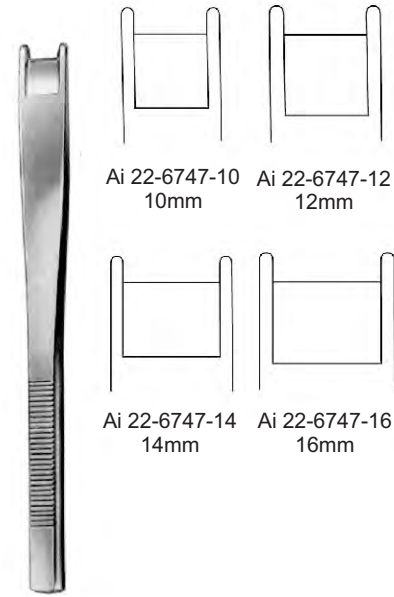


COTTLE
 Ai 22-6745-18
 18.0cm



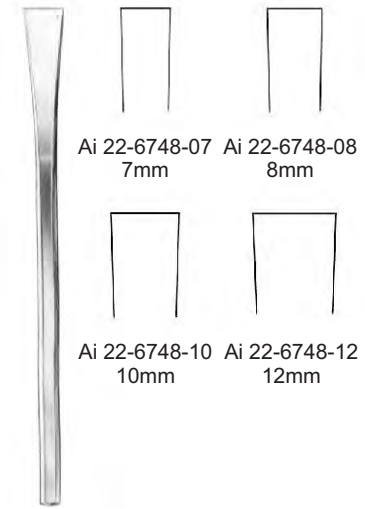
Ai 22-6746-04 4mm
 Ai 22-6746-05 5mm
 Ai 22-6746-06 6mm
 Ai 22-6746-07 7mm

FOMON
 17.0cm



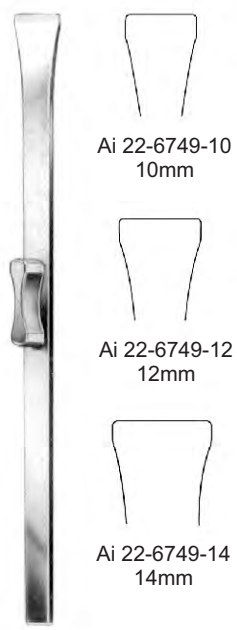
Ai 22-6747-10 10mm
 Ai 22-6747-12 12mm
 Ai 22-6747-14 14mm
 Ai 22-6747-16 16mm

CINELLI
 16.0cm



Ai 22-6748-07 7mm
 Ai 22-6748-08 8mm
 Ai 22-6748-10 10mm
 Ai 22-6748-12 12mm

SHEEHAN
 17.0cm



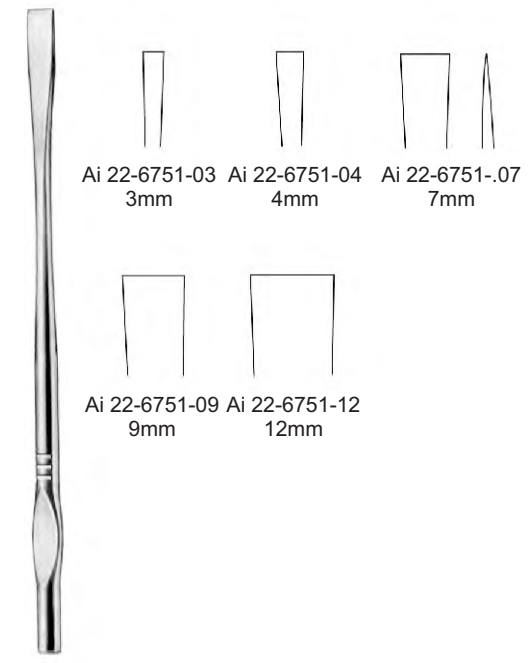
Ai 22-6749-10 10mm
 Ai 22-6749-12 12mm
 Ai 22-6749-14 14mm

RUBIN
 18.0cm



Ai 22-6750-03 3mm
 Ai 22-6750-04 4.5mm

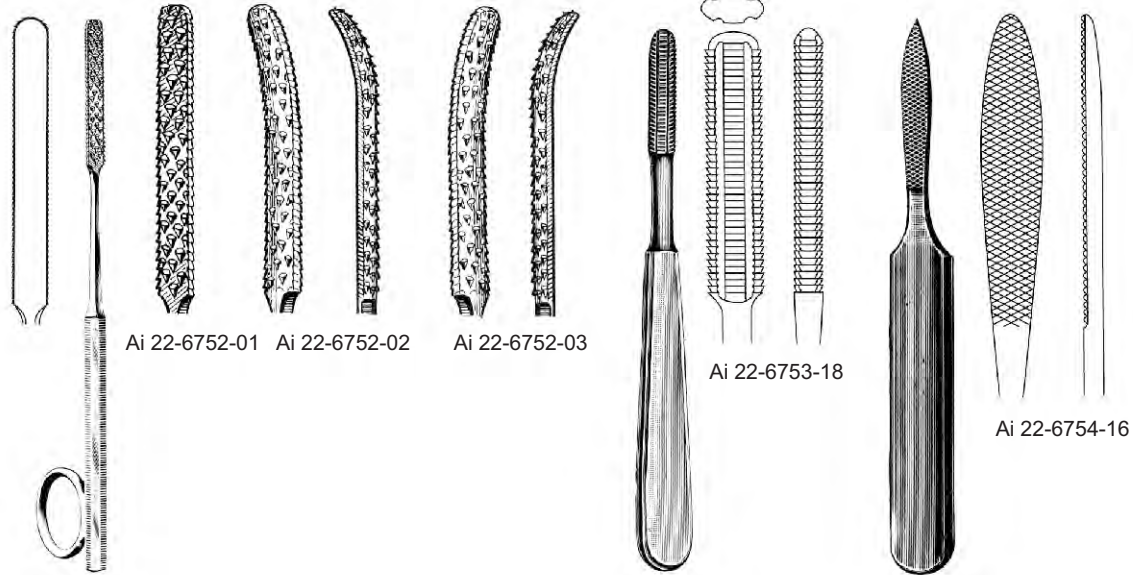
WALTER
 19.0cm



Ai 22-6751-03 3mm
 Ai 22-6751-04 4mm
 Ai 22-6751-07 7mm
 Ai 22-6751-09 9mm
 Ai 22-6751-12 12mm

WALTER
 19.0cm

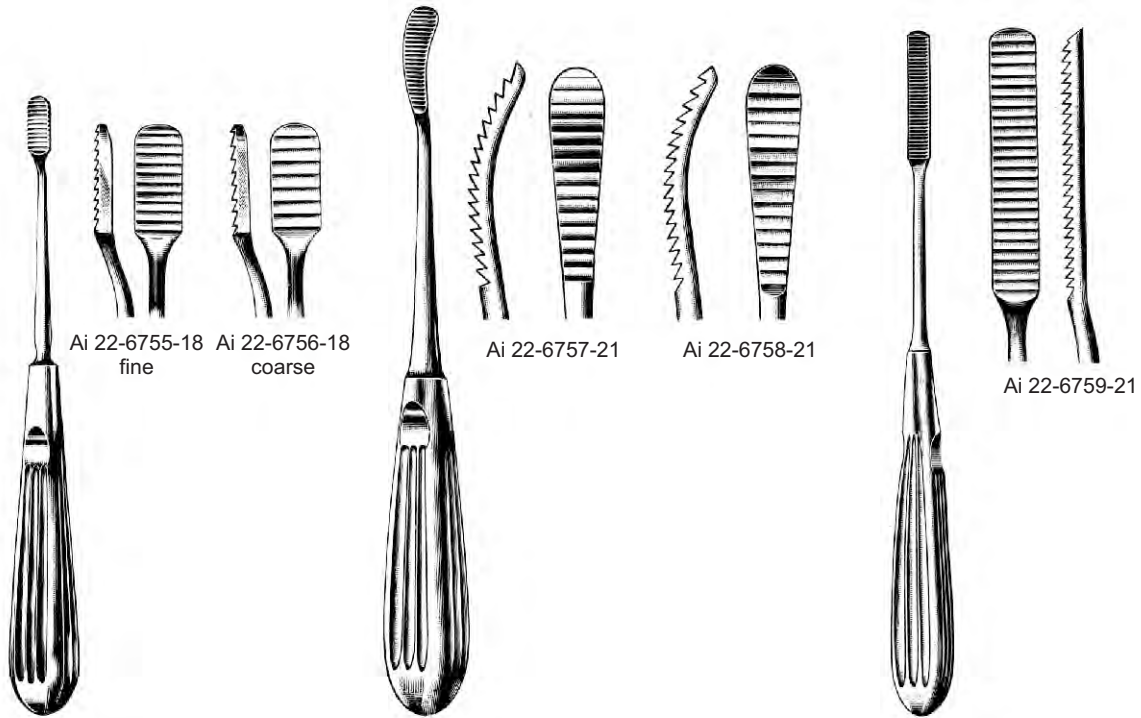




GALLAHER
16.0cm

MALTZ
18.0cm

JOSEPH
16.0cm



LEWIS
18.0cm

AUFRICHT
21.0cm

COTTLE
21.0cm



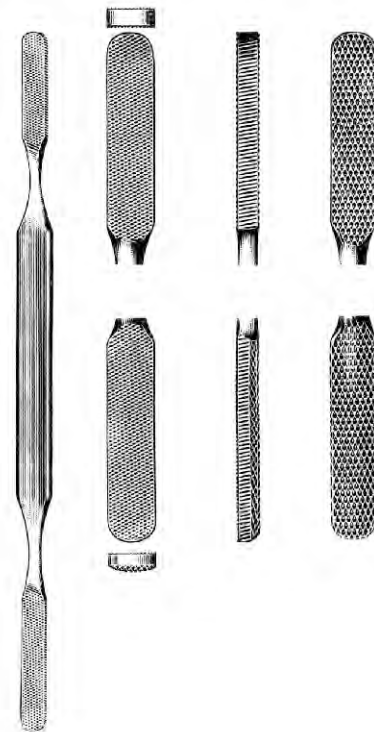
WIENER
18.0cm



Ai 22-6760-18



Ai 22-6761-18



FOMON
Ai 22-6762-21
21.0cm





KILNER
 Ai 22-6763-10
 10.0cm



CONVERSE
 Ai 22-6764-12
 12.0cm



AUFRICHT
 Ai 22-6765-16
 16.0cm



AUFRICHT
 Ai 22-6766-19
 19.0cm



15.0cm



Ai 22-6767-01



Ai 22-6767-02



Ai 22-6767-03



LANGE
 Ai 22-6768-22
 22.0cm



FOMON
 Ai 22-6769-17
 17.0cm



COTTLE
 Ai 22-6770-16
 16.0cm



FREER
 Ai 22-6771-15
 15.0cm

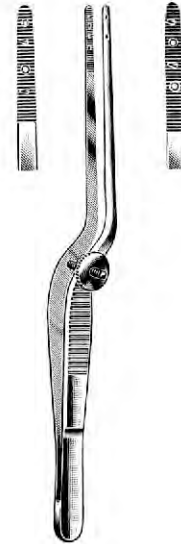




OGURA
 Ai 22-6772-11
 11.0cm



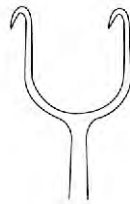
COTTLE
 Ai 22-6773-11
 11.0cm



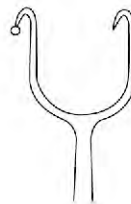
COTTLE
 Ai 22-6774-14
 14.0cm



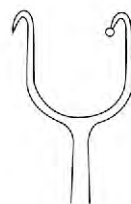
COTTLE
 15.0cm



Ai 22-6775-14



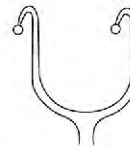
Ai 22-6775-01



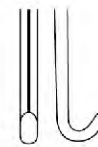
Ai 22-6775-02



FOMON
 Ai 22-6776-16
 16.0cm



COTTLE-NEIVERT
 Ai 22-6777-20
 20.0cm





YANKAUER

Ai 22-6778-01 Ai 22-6778-02 Ai 22-6778-03 Ai 22-6778-04 Ai 22-6778-05



Ai 22-6778-06 Ai 22-6778-07 Ai 22-6778-08 Ai 22-6778-09



COTTLE
Ai 22-6779-14
14.0cm



NEIVERT
Ai 22-6780-16
16.0cm



COTTLE
Ai 22-6781-15
15.0cm



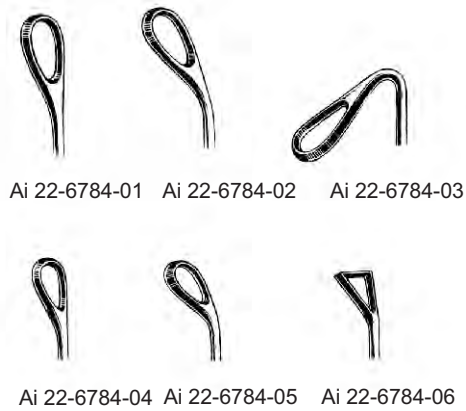
COTTLE
Ai 22-6782-15
15.0cm



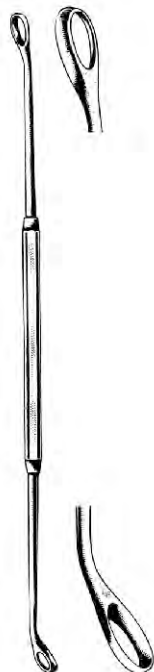
AUFRICHT
Ai 22-6783-13
13.5cm



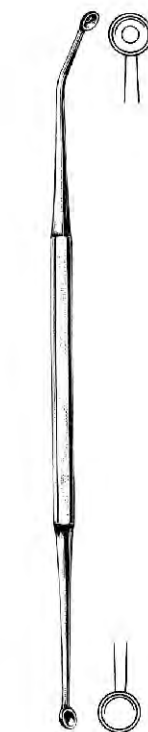
COAKLEY
17.0cm



MYLES
17.0cm



Ai 22-6786-12
12.0cm



PRATT
Ai 22-6787-21
21.0cm



FAULKNER
Ai 22-6788-21
21.0cm





KRESSNER
 Ai 22-6789-20
 20.0cm



ASCH
 Ai 22-6790-23
 23.0cm



Ai 22-6791-23
 straight



Ai 22-6792-23
 left



Ai 22-6793-23
 right



COTTLE-WALSHAM
 23.0cm



BECKMANN
22.0cm



BECKMANN
22.0cm



Ai 22-6794-01
Ai 22-6795-01



Ai 22-6794-02
Ai 22-6795-02



Ai 22-6794-03
Ai 22-6795-03



Ai 22-6794-04
Ai 22-6795-04



Ai 22-6794-05
Ai 22-6795-05



Ai 22-6794-06
Ai 22-6795-06



BECKMANN
22.0cm



Ai 22-6796-01



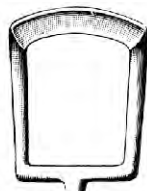
Ai 22-6796-02



Ai 22-6796-03



Ai 22-6796-04



Ai 22-6796-05



ST. CLAIR-THOMSON
21.0cm



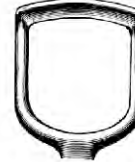
Ai 22-6797-08
8mm



Ai 22-6797-10
10mm



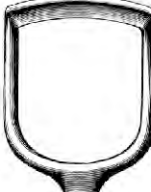
Ai 22-6797-12
12mm



Ai 22-6797-14
14mm



Ai 22-6797-16
16mm



Ai 22-6797-18
18mm





BRUENINGS-BRUNK
 Ai 22-6798-21
 21.5cm



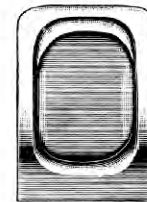
LA FORCE
 25.0cm



1



2



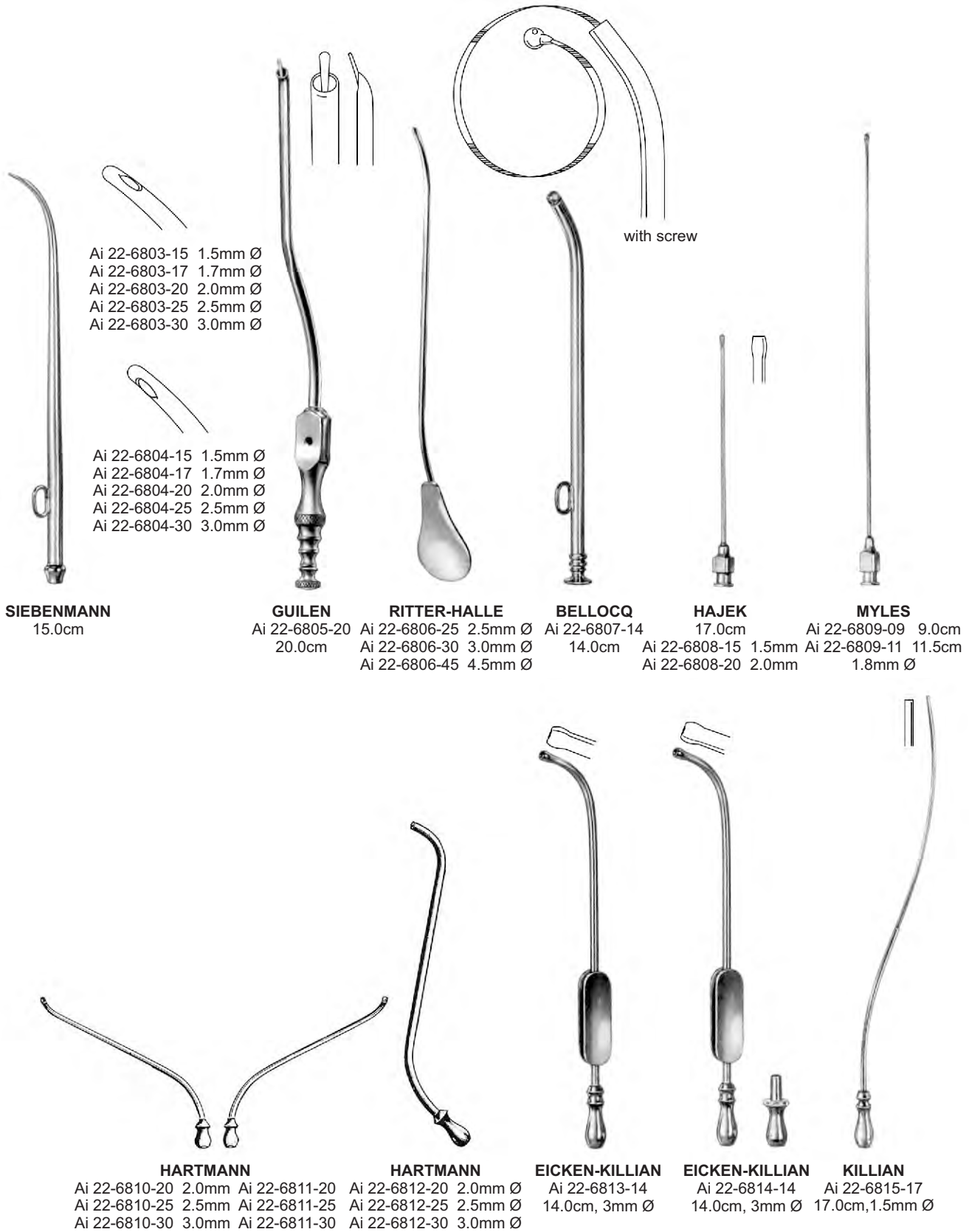
3

with unperforated blade
 Ai 22-6799-01 Fig. 1
 Ai 22-6799-02 Fig. 2
 Ai 22-6799-03 Fig. 3

spare blades
 Ai 22-6801-01 Fig. 1
 Ai 22-6801-02 Fig. 2
 Ai 22-6801-03 Fig. 3

with perforated blade
 Ai 22-6800-01
 Ai 22-6800-02
 Ai 22-6800-03

Ai 22-6802-01
 Ai 22-6802-02
 Ai 22-6802-03

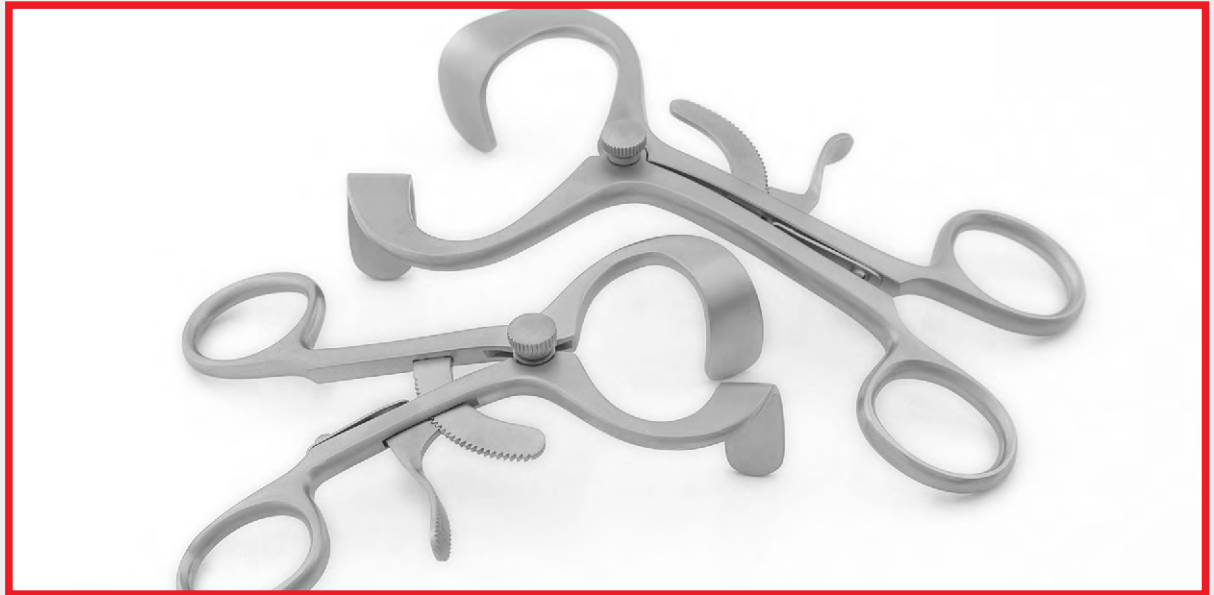


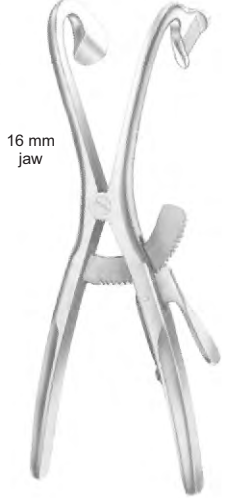
EN Oral Instruments

DE Mund instrumente

ES Cirugía oral

Page 575 to 594





16 mm jaw

DENHART
Ai 23-6901-12
12 cm/4 3/4"

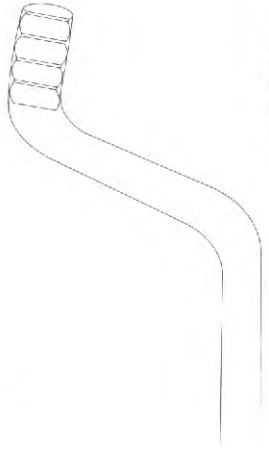


Silicon jaws only (pair)
Ai 23-6903-12

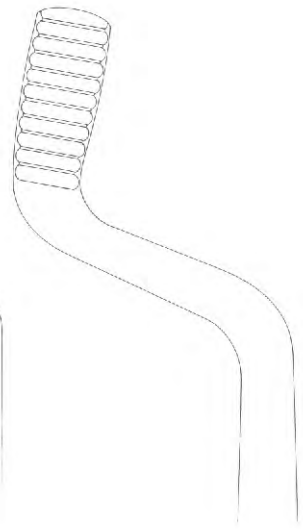
DENHART
Ai 23-6902-12
12 cm/4 3/4"



ROSER-KONIG

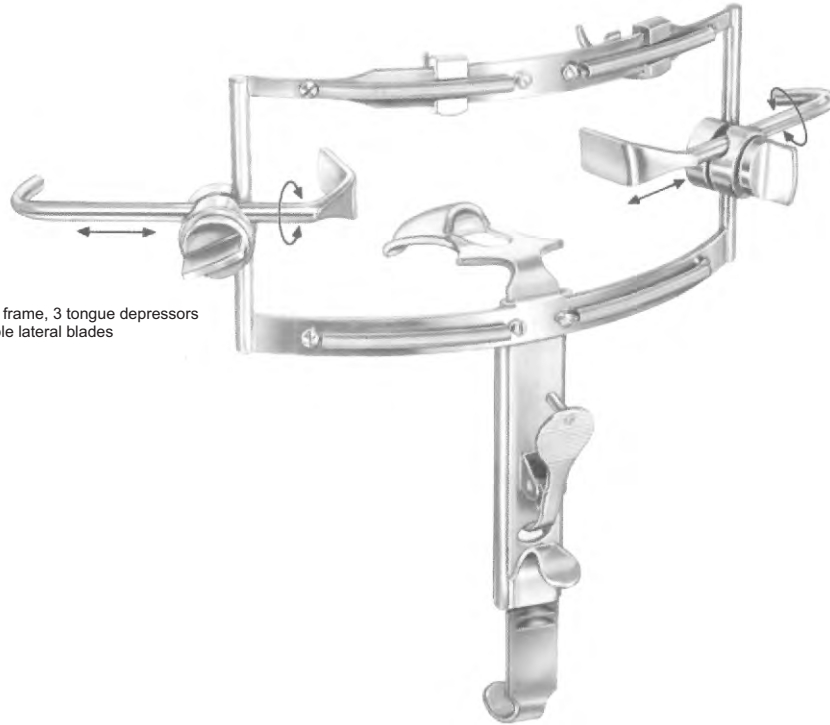


Ai 23-6904-16
16 cm/6 1/4"

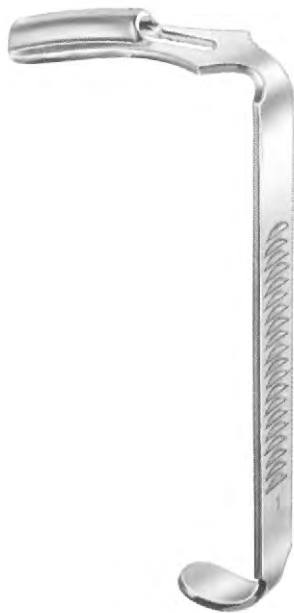


Ai 23-6904-19
19 cm/7 1/2"

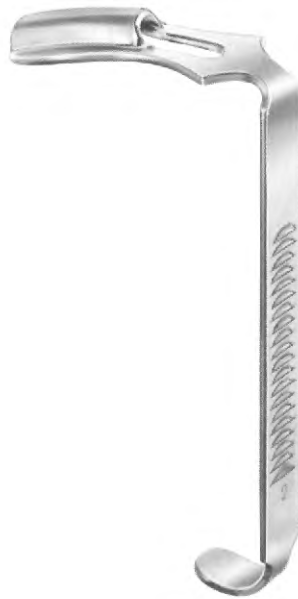
complete, with frame, 3 tongue depressors
 and 2 adjustable lateral blades



DINGMAN
 Ai 23-6905-00
 Complete set
 Fig. 1 - 3



Ai 23-6906-01
 62 mm x 26 mm



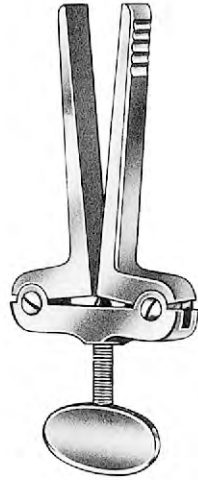
Ai 23-6907-02
 65 mm x 30 mm



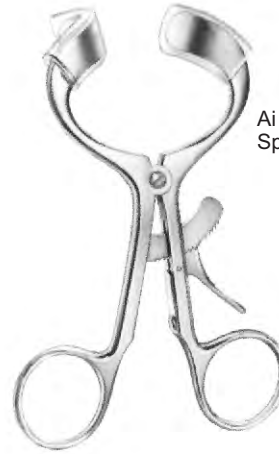
Ai 23-6908-03
 78 mm x 32 mm

Tongue Depressors





HEISTER
 Ai 23-6909-13
 13 cm/5 1/8"



Ai 23-6911-11
 Spare rubber

MOLT
 Ai 23-6910-11
 11 cm/4 3/8"



Ai 23-6913-13
 Spare Rubber

MOLT
 Ai 23-6912-13
 13 cm/5 1/8"



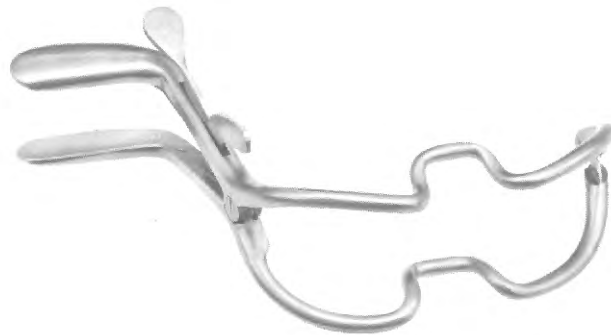
SPREADING
 47 mm

OBWEGESER
 Ai 23-6914-11
 11 cm/4 3/8"



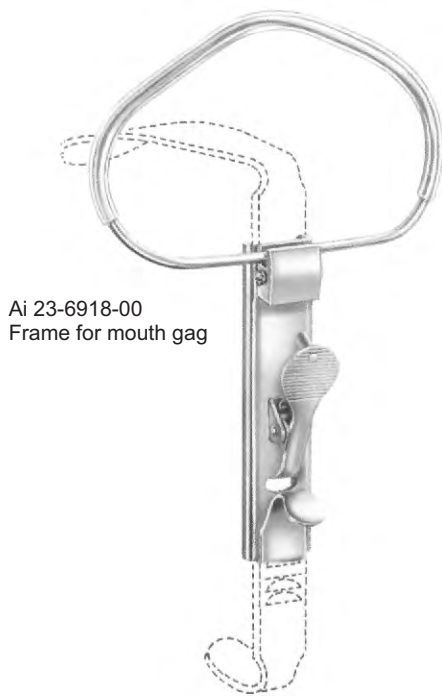
WHITEHEAD

Ai 23-6915-11 11 cm/4 $\frac{3}{8}$ "
 Ai 23-6915-13 13 cm/5 $\frac{1}{8}$ "
 Ai 23-6915-15 15 cm/5 $\frac{7}{8}$ "



JENNINGS

Ai 23-6916-09 9 cm/3 $\frac{1}{2}$ "
 Ai 23-6916-11 11 cm/4 $\frac{3}{8}$ "
 Ai 23-6916-13 13 cm/5 $\frac{1}{8}$ "
 Ai 23-6916-15 15 cm/5 $\frac{7}{8}$ "



Ai 23-6918-00
Frame for mouth gag

McLVOR
Ai 23-6917-00
Complete with 3
tongue depressors

Tongue Depressors

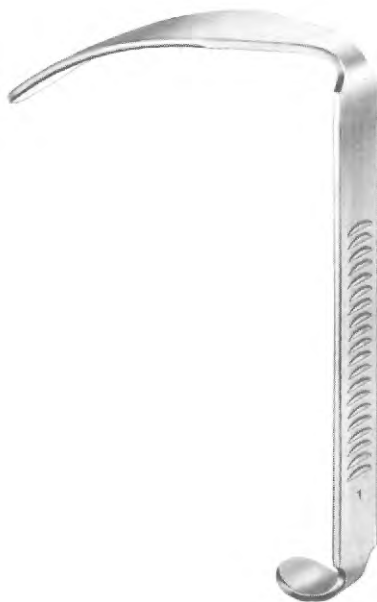


Fig. 1
Ai 23-6919-01
100 x 25 mm



Fig. 2
Ai 23-6920-02
85 x 25 mm

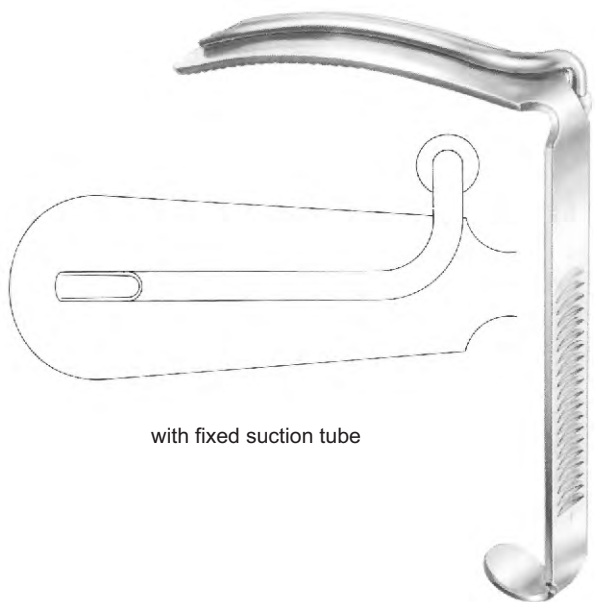


Fig. 3
Ai 23-6921-03
75 x 25 mm

Ai 23-6923-00
 Frame for mouth gag



DAVIS-BOYLE
 Ai 23-6922-00
 Complete, consisting of frame
 and 5 tongue depressors no. 1 - 5



with fixed suction tube

Fig. 1
 Ai 23-6924-01
 110 x 28 mm



Fig. 2
 Ai 23-6925-02
 95 x 27 mm



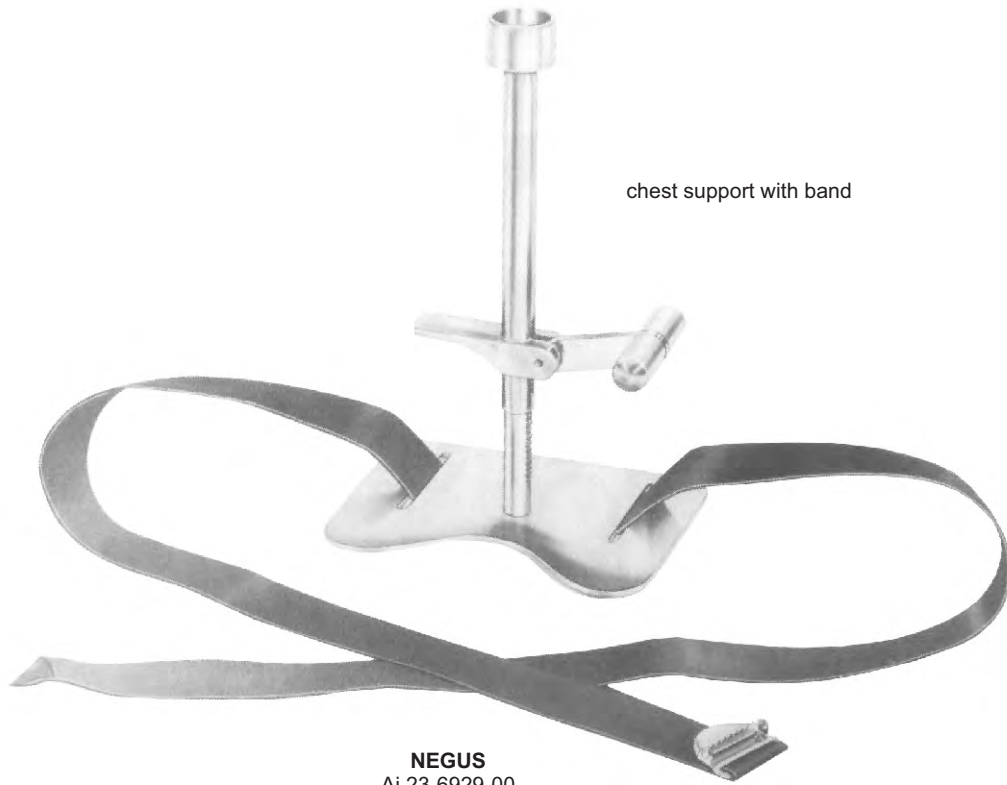
Fig. 3
 Ai 23-6926-03
 80 x 27 mm



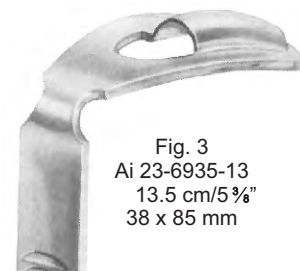
Fig. 4
 Ai 23-6927-04
 65 x 26 mm



Fig. 5
 Ai 23-6928-05
 30 x 20 mm



KILNER-DOUGHTY
 Ai 23-6930-00



complete, consisting of frame and 3 tongue depressors
 no. 1 to 3, 2 tooth plates and 1 palate plate

NEUKAM
 Ai 23-6937-00
 frame for mouth gag only



NEUKAM
 Ai 23-6936-00
 complete with frame and
 3 tongue depressors

Tongue Depressor
 fenestrated blade for suction



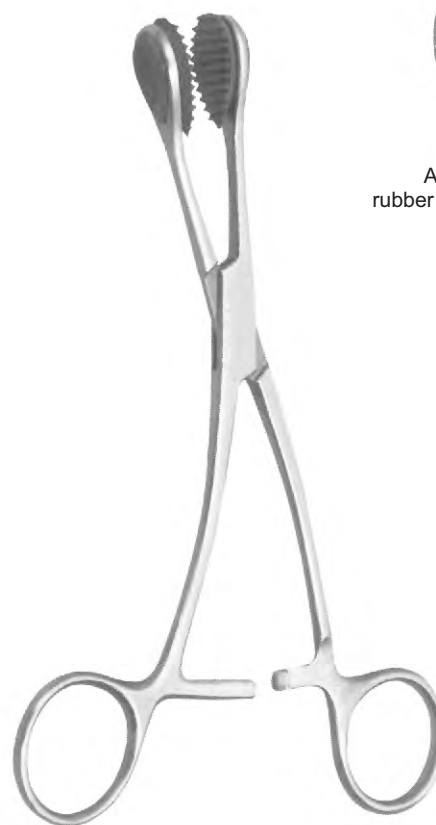
Fig. 1
 Ai 23-6938-01

Fig. 2
 Ai 23-6939-02

Fig. 3
 Ai 23-6940-03



COLLIN
 Ai 23-6941-16 16 cm/6 1/4"
 Ai 23-6941-18 18 cm/7 1/8"



YOUNG
 Ai 23-6942-16
 16 cm/6 1/4"



Ai 23-6943-16
 rubber inserts, only (pair)





Ai 23-6944-15
 15 cm/5 7/8"
 wood
 19 mm



Ai 23-6945-15
 15 cm/5 7/8"
 plastic



BRUNINGS
 Ai 23-6946-19
 19 cm/7 1/2"



16 mm

Ai 23-6947-14
 14.5 cm/5 3/4"



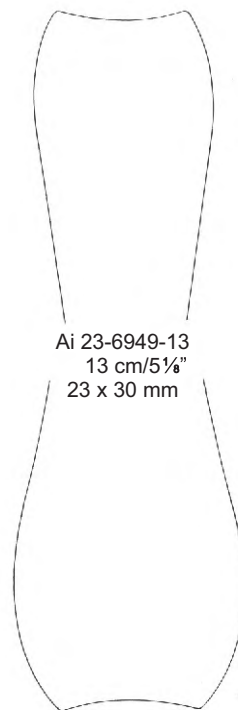
19 mm

23 mm

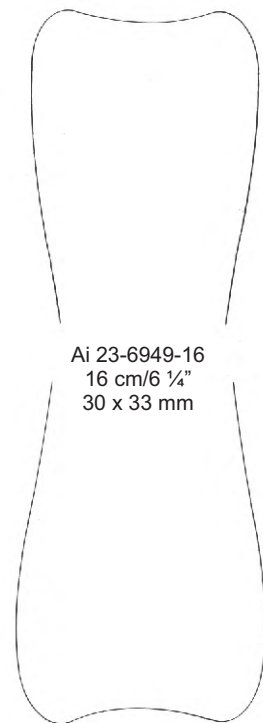
Ai 23-6948-14
 14 cm/5 1/2"



DOYEN



Ai 23-6949-13
 13 cm/5 1/8"
 23 x 30 mm

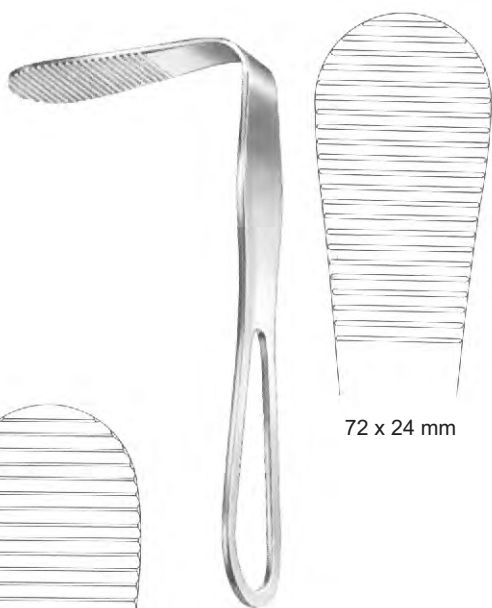


Ai 23-6949-16
 16 cm/6 1/4"
 30 x 33 mm



TOBOLD
Ai 23-6950-15
15 cm/5 7/8"

80 x 25 mm



HARTMANN
Ai 23-6951-15
15 cm/5 7/8"

72 x 24 mm



TOBOLD
Ai 23-6952-16
16 cm/6 1/4"

83 x 25 mm

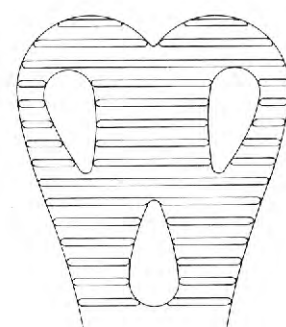


BUCHWALD
Ai 23-6953-18
18 cm/7 1/8"

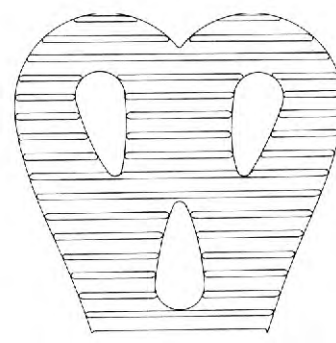


ANDREW
Ai 23-6954-11
11 cm/4 3/8"

WIEDER



Ai 23-6955-14
14 cm/5 1/2"
36 mm



Ai 23-6955-15
15 cm/5 7/8"
43 mm



MARTIN-SIMPLEX
 Ai 23-6956-10
 10.5 cm/4 1/8"



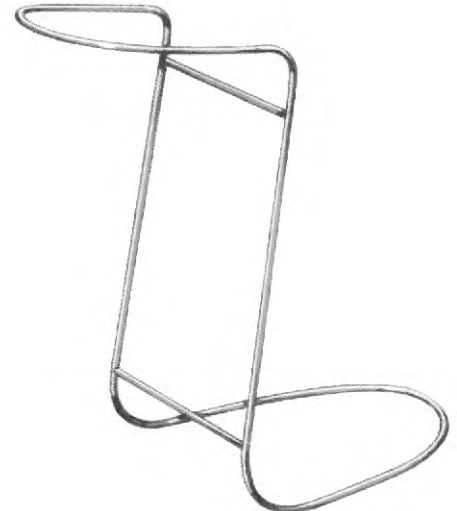
Ai 23-6957-14
 14 cm/5 1/2"
 Vestibulum retractor



STERNBERG
 Ai 23-6958-14
 14 cm/5 1/2"

26 mm

37 mm



OBWEGESER
 Ai 23-6959-12
 12 cm/4 3/4"



BISHOP
 Ai 23-6960-13
 13.5 cm/5 3/8"

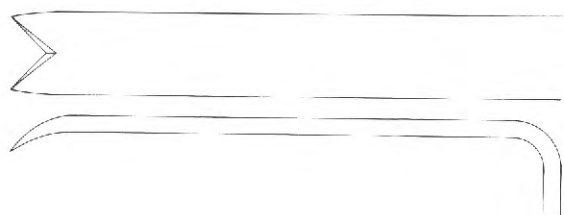


CAWOOD-MINNESOTA
 Ai 23-6961-15
 15.5 cm/6 1/8"



CAWOOD-MINNESOTA
 Ai 23-6962-14
 14.5 cm/5 3/4"





72 x 10 mm



OBWEGESER
 Ai 23-6963-22
 22 cm/8 3/4"



OBWEGESER
 Ai 23-6964-16
 16.5 cm/6 1/2"



Ai 23-6965-16
 16 cm/6 1/4"
 8 mm

Ai 23-6966-16
 16 cm/6 1/4"
 10 mm

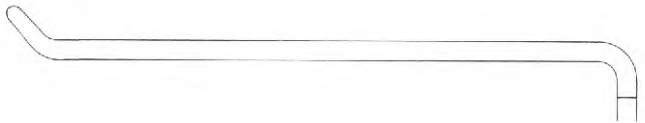
OBWEGESER



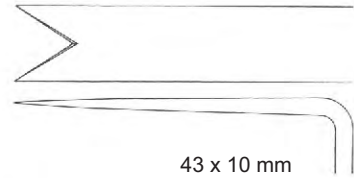
Ai 23-6967-22
22.5 cm/8 3/4"
43 x 11 mm



Ai 23-6967-23
23 cm/9"
57 x 11 mm



Ai 23-6968-23
23 cm/9"
80 x 16 mm



43 x 10 mm



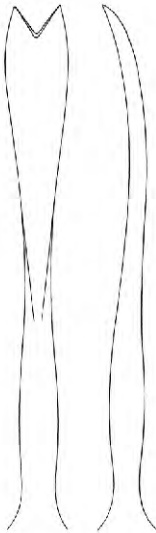
OBWEGESER



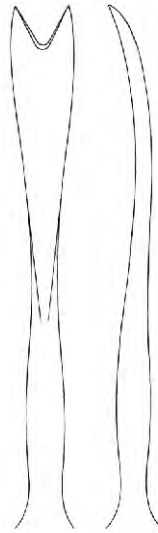
OBWEGESER
Ai 23-6969-22
22 cm/8 3/4"
Nasal Spine Retractor



OBWEGESER
 17.5 cm/6 7/8"



Ai 23-6970-17



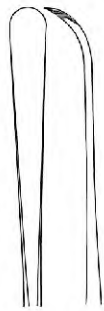
Ai 23-6971-17



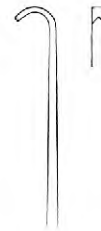
KRENKEL
 24.5 cm/9 5/8"



Ai 23-6972-24
 Periosteal Elevator



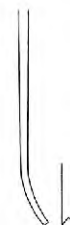
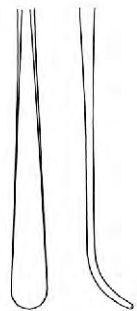
Ai 23-6973-24
 Periosteal Elevator



Ai 23-6974-24
 Condylar repositioning
 instrument
 Fig. 11



Ai 23-6975-24
 Fig. 12





OBWEGESER
 17.5 cm/6 7/8"



Ai 23-6976-17
 6 mm



Ai 23-6977-17
 7 mm



Ai 23-6978-17
 9 mm



Ai 23-6979-17



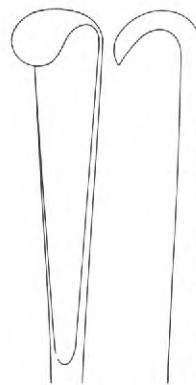
OBWEGESER
 20 cm/7 7/8"



Ai 23-6980-20
 5 mm



Ai 23-6981-20
 7 mm



Ai 23-6982-20
 9 mm



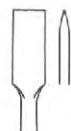
OBWEGESER
 Ai 23-6983-20
 20.5 cm/8 1/8"



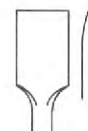
OBWEGESER
 Ai 23-6984-20
 20.5 cm/8 1/8"



Ai 23-6985-15
 2.5 mm



Ai 23-6986-15
 4.0 mm



Ai 23-6987-15
 6.5 mm

OBWEGESER
 15 cm/5 7/8"



OBWEGESER
 Ai 23-6988-23
 23.5 cm/9 ¼"



Ai 23-6989-18



Ai 23-6990-18

OBWEGESER
 18.5 cm/7 ¼"



OBWEGESER
 Ai 23-6991-18
 18 cm/7 ⅙"



OBWEGESER
 Ai 23-6992-14
 14 cm/5 ½"



OBWEGESER
 Ai 23-6993-23
 23 cm/9"



Awl for lower jaw

KELSEY-FRY
 Ai 23-6994-15
 15 cm/5 7/8"



Awl for upper jaw

KELSEY-FRY
 Ai 23-6995-18
 18 cm/7 1/8"

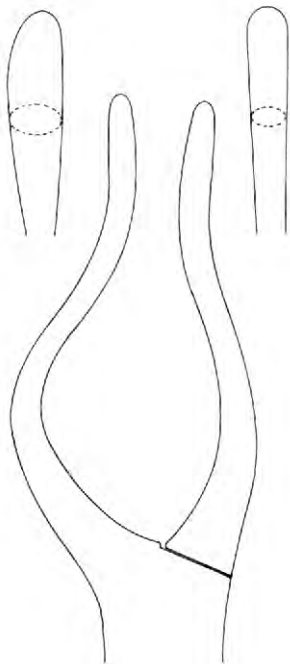


Fig. 1
for babies

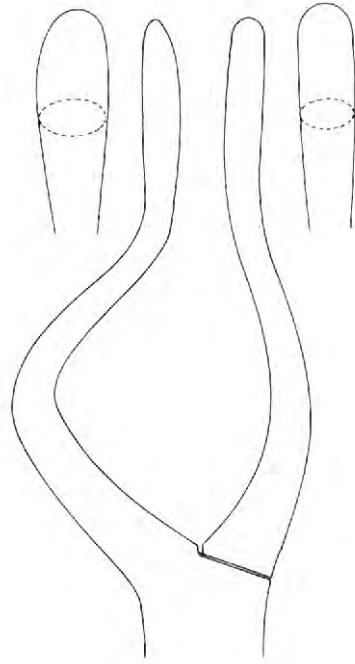


Fig. 2
for children

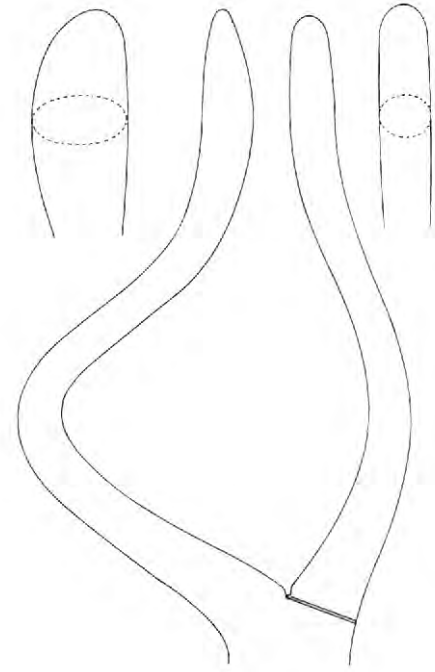


Fig. 3
for adults



Left

ROWE

Ai 23-6996-22 Fig. 1 22.5 cm
 Ai 23-6996-23 Fig. 2 23.5 cm
 Ai 23-6996-24 Fig. 3 24.0 cm



Right

ROWE

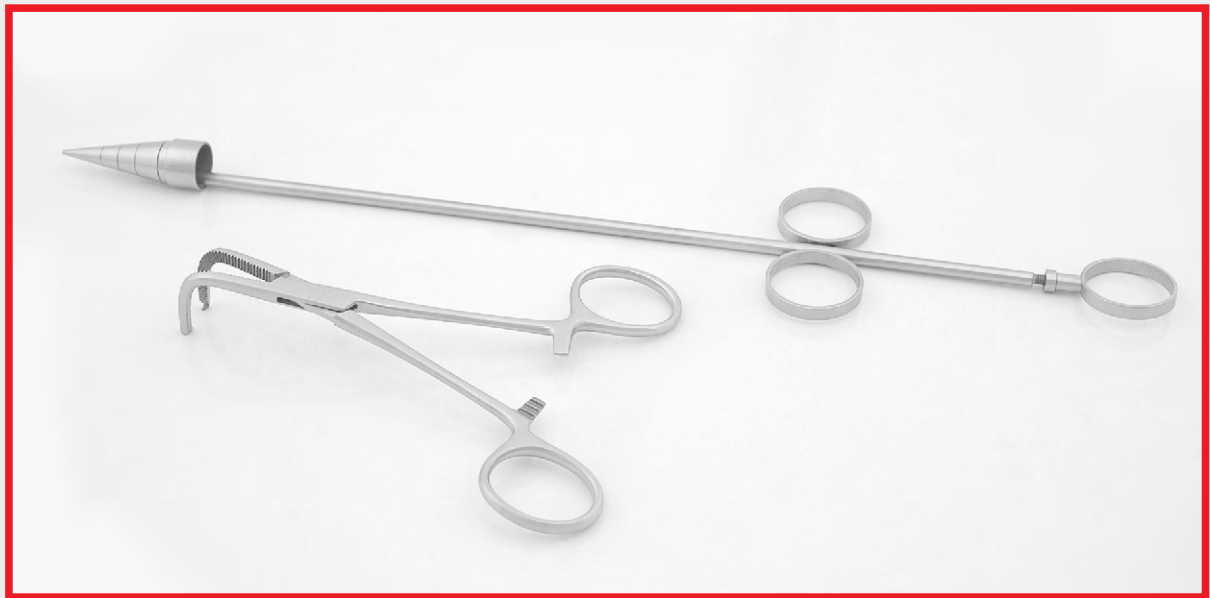
Ai 23-6997-22 Fig. 1 22.5 cm
 Ai 23-6997-23 Fig. 2 23.5 cm
 Ai 23-6997-24 Fig. 3 24.0 cm

EN Stomach, Intestine, Rectum

DE Magen, Darm, Mastdarm

ES Estómago, Intestinos, Recto

Page 595 to 619





Allis

cm	in	4 : 5	5 : 6
15	6"	Ai 24-7101-15	Ai 24-7102-15
19	7½"	Ai 24-7101-19	Ai 24-7102-19
23	9"	Ai 24-7101-23	Ai 24-7102-23
25	10"	Ai 24-7101-25	Ai 24-7102-25



Baby-Allis

Ai 24-7103-12	12 cm/4¾"
Ai 24-7103-14	14 cm/5½"



Allis-Atrauma

Ai 24-7104-16	16 cm/6¼"
Ai 24-7104-20	20 cm/8"
Ai 24-7104-25	25 cm/10"
Ai 24-7104-30	30 cm/12"



Allis-Adair
 Ai 24-7105-15
 15 cm/6"



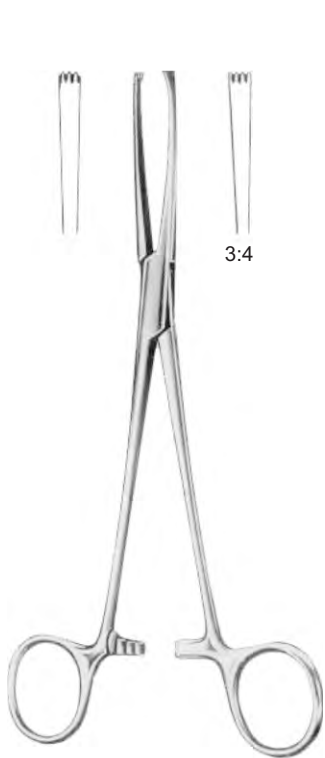
Boys-Allis
 Ai 24-7106-15
 15 cm/6"



Lockwood-Allis
 Ai 24-7107-16 16 cm/6¼"
 Ai 24-7107-20 20 cm/8"



Thoms-Allis
 Ai 24-7108-20
 20 cm/8"



Judd-Allis
 Ai 24-7109-15 15 cm/6"
 Ai 24-7109-19 19 cm/7 1/2"



Littlewood
 Ai 24-7110-18
 18.5 cm/7 1/4"



Williams
 Ai 24-7111-16
 16 cm/6 1/4"



Lockwood
 Ai 24-7112-20
 20 cm/8"

Atrauma



cm/in
Babcock-Atrauma
 16 cm/6 1/4" Ai 24-7113-16
 18 cm/7" Ai 24-7113-20
 20 cm/8"
 24 cm/9 1/2"



Babcock(Standard)
 Ai 24-7114-16
 Ai 24-7114-18
 Ai 24-7114-20
 Ai 24-7114-24



Baby-Babcock
 Ai 24-7115-16

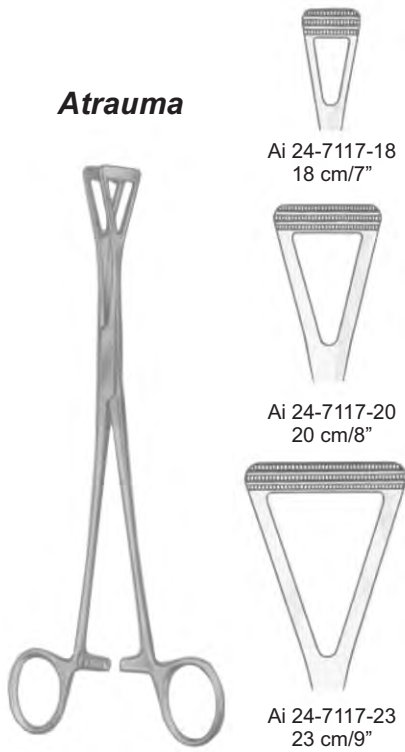


Babcock
 Ai 24-7116-16
 Ai 24-7116-18
 Ai 24-7116-20
 Ai 24-7116-24

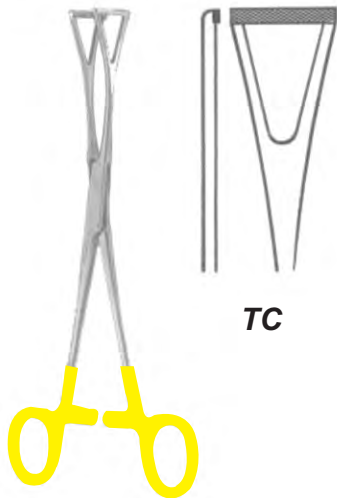




Atrauma



	Duval		
	cm	in	
Ai 24-7118-18	18	7"	Ai 24-7119-18
Ai 24-7118-20	20	8"	Ai 24-7119-20
Ai 24-7118-23	23	9"	Ai 24-7119-23



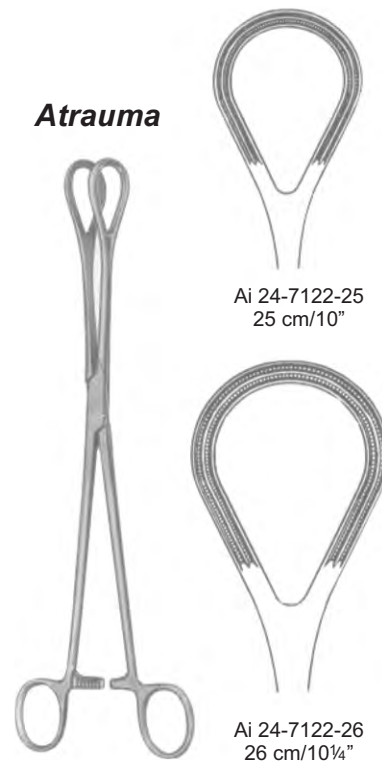
Duval
 Ai 24-7120-20
 20 cm/8"



Child
 Ai 24-7121-24
 24 cm/9½"

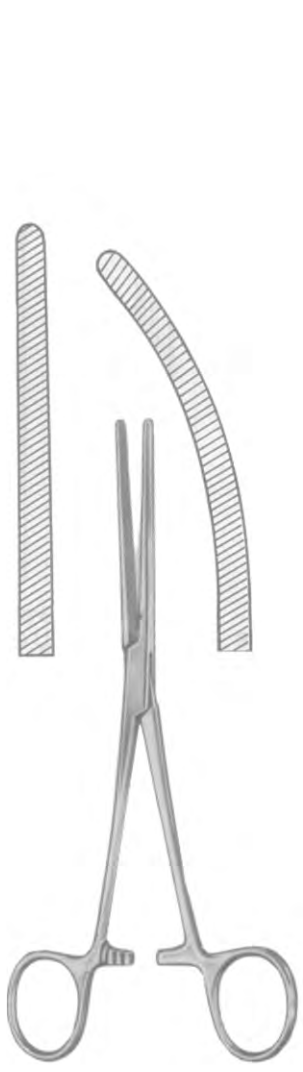
Ai 24-7121-00
 Pair

Atrauma

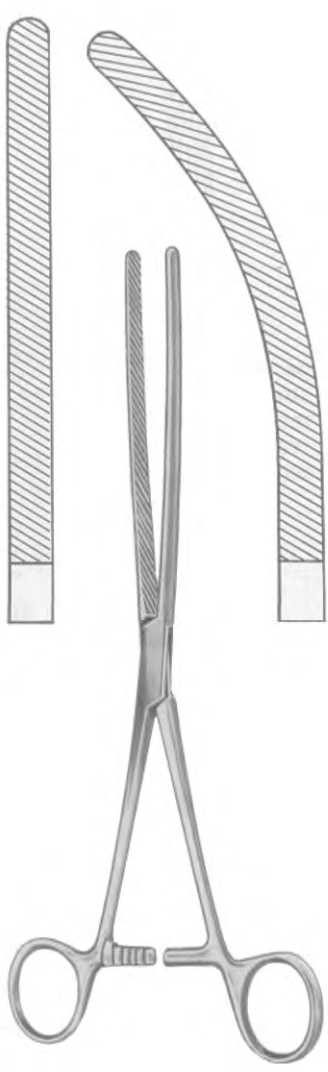


Ai 24-7122-25
 25 cm/10"

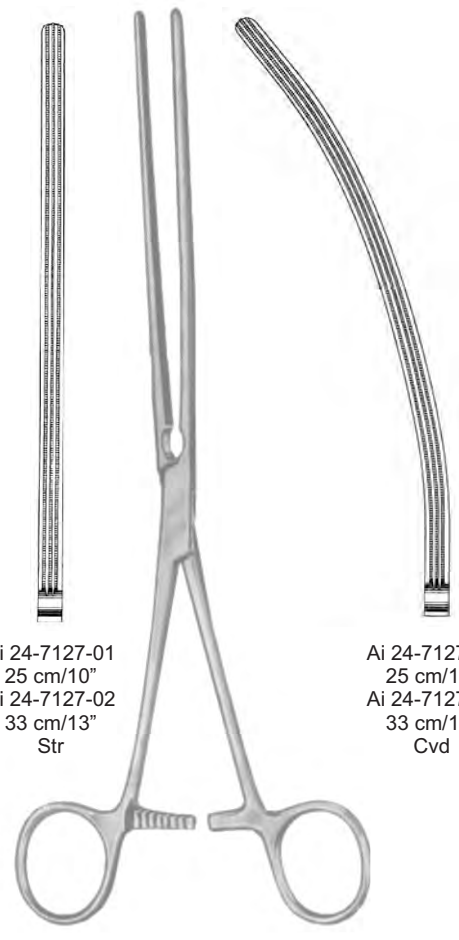
Ai 24-7122-26
 26 cm/10¼"



Baby-Doyen
 Straight Ai 24-7123-18 18 cm/7"
 Curved Ai 24-7124-18 18 cm/7"



Doyen
 Straight Ai 24-7125-21 21 cm/8¼"
 Ai 24-7125-23 23 cm/9"
 Curved Ai 24-7126-21 21 cm/8¼"
 Ai 24-7126-23 23 cm/9"



Ai 24-7127-01 25 cm/10"
 Ai 24-7127-02 33 cm/13" Str
 Ai 24-7127-03 25 cm/10"
 Ai 24-7127-04 33 cm/13" Cvd

Scudder





Doyen-Atrauma

Atrauma

Straight



Ai 24-7128-13
13 cm/5"



Ai 24-7128-16
16 cm/6¼"



Ai 24-7128-18
18 cm/7"



Ai 24-7128-21
21 cm/8¼"



Ai 24-7128-23
23 cm/9"

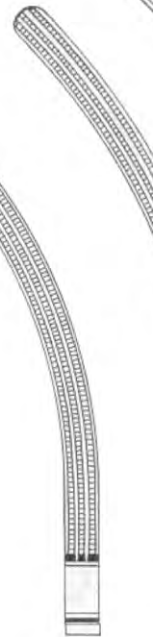
Curved



Ai 24-7129-13
13 cm/5"



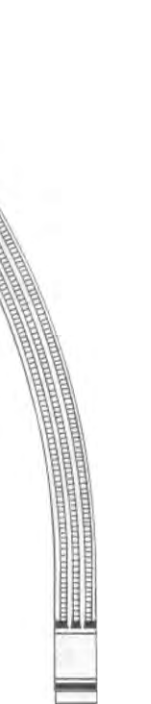
Ai 24-7129-16
16 cm/6¼"



Ai 24-7129-18
18 cm/7"



Ai 24-7129-21
21 cm/8¼"



Ai 24-7129-23
23 cm/9"

Atrauma



**Mayo-Robson
 Mayo-Robson Atrauma**



Ai 24-7130-21
 21 cm/8¼"



Ai 24-7131-21
 21 cm/8¼"



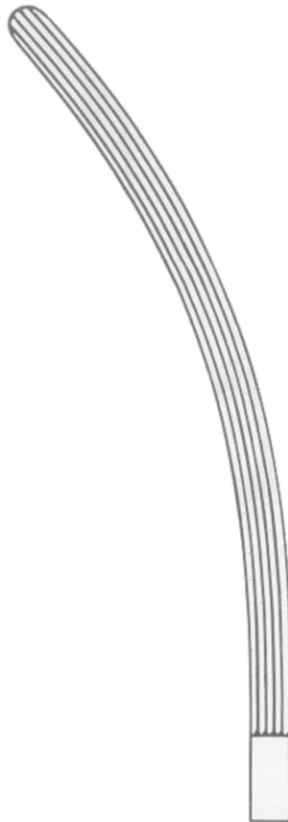
Ai 24-7132-23
 23 cm/9"



Ai 24-7133-23
 23 cm/9"



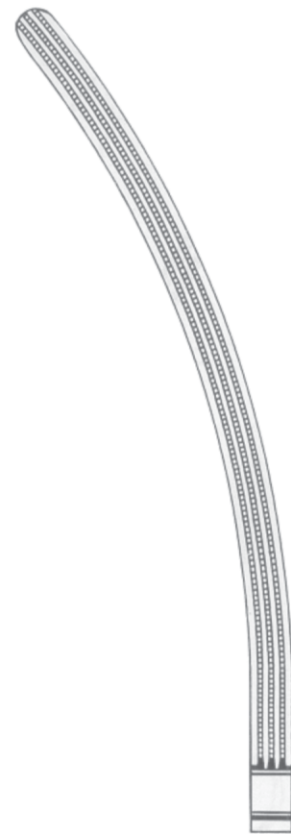
Ai 24-7134-25
 25 cm/10"



Ai 24-7135-25
 25 cm/10"

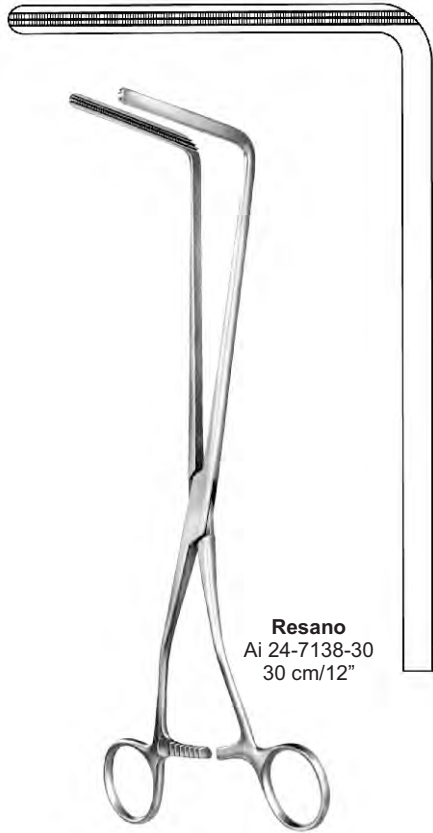


Ai 24-7136-25
 25 cm/10"



Ai 24-7137-25
 25 cm/10"

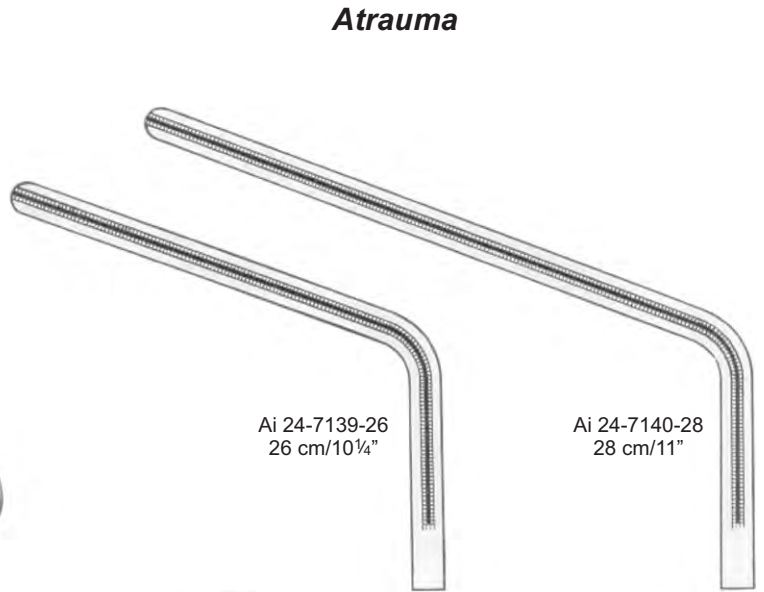




Resano
Ai 24-7138-30
30 cm/12"



Hayes



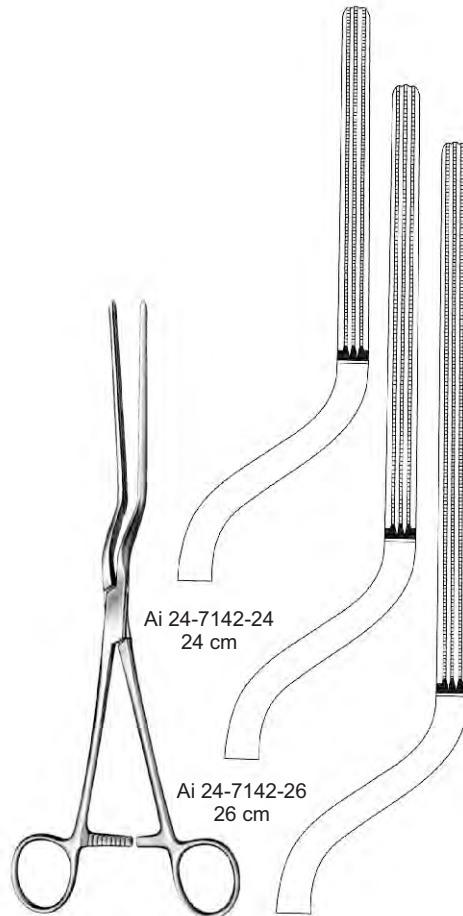
Atrauma

Ai 24-7139-26
26 cm/10¼"

Ai 24-7140-28
28 cm/11"



Fehland
Ai 24-7141-24
24 cm/9½"



Ai 24-7142-24
24 cm

Ai 24-7142-26
26 cm



Straight **Baby-Kocher** Curved
Ai 24-7144-13 13 cm/5"
Ai 24-7145-13 13 cm/5"



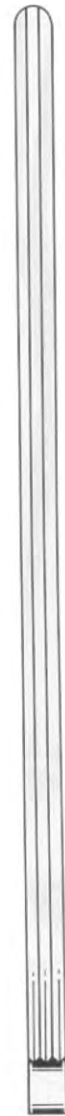
Kocher



Ai 24-7146-22
22 cm/8¾"



Ai 24-7146-25
25 cm/10"



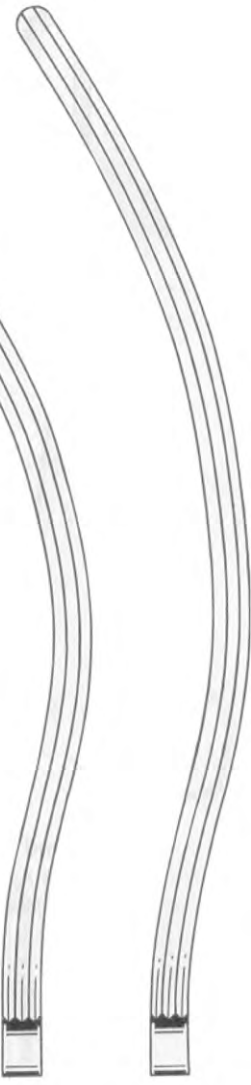
Ai 24-7146-28
28 cm/11"



Ai 24-7147-22
22 cm/8¾"



Ai 24-7147-25
25 cm/10"



Ai 24-7147-28
28 cm/11"

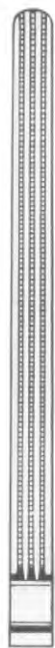




Atrauma



Kocher-Atrauma



Ai 24-7148-22
22 cm/8¾"



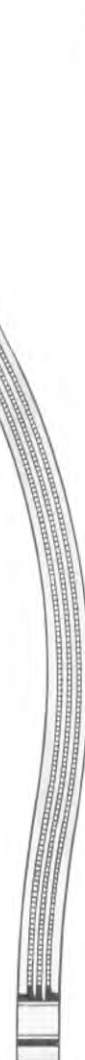
Ai 24-7148-25
25 cm/10"



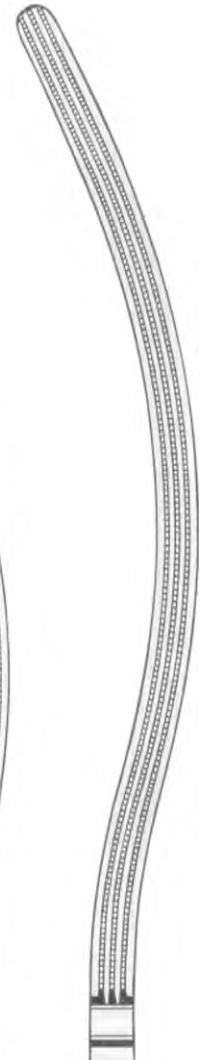
Ai 24-7148-28
28 cm/11"



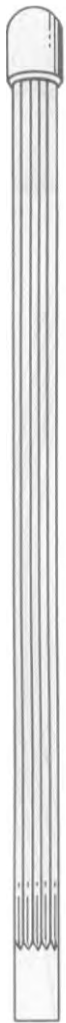
Ai 24-7149-22
22 cm/8¾"



Ai 24-7149-25
25 cm/10"



Ai 24-7149-28
28 cm/11"



Straight
Ai 24-7151-25
Ai 24-7151-30



Nussbaum
25 cm/10"
30 cm/12"



Curved
Ai 24-7152-25
Ai 24-7152-30



Pylorus spreader

Benson
Ai 24-7150-15
15.5 cm/6"



Allen
Ai 24-7153-15 15.5 cm/6"
Ai 24-7153-20 20.0 cm/8"



Kleinschmidt
Ai 24-7154-12
12 cm/4¾"

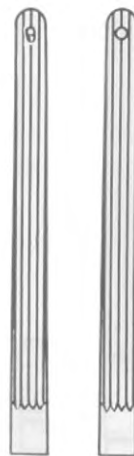
Blindgut forceps



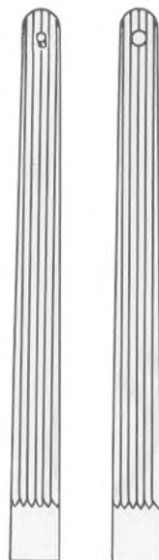


Payr
(Payr-Baby)

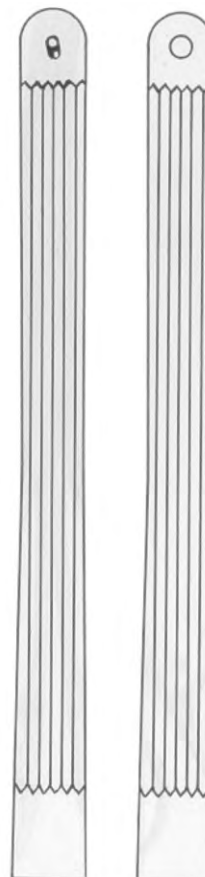
For children



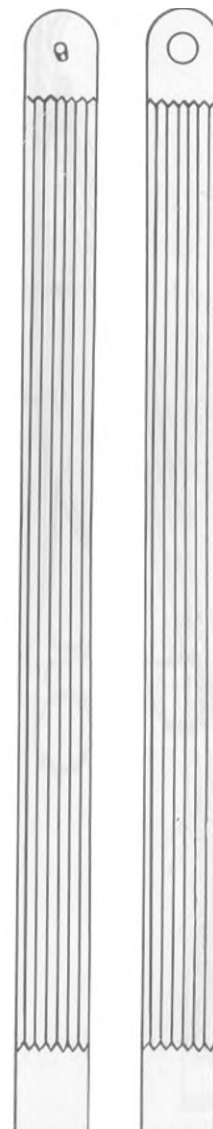
Ai 24-7155-15
15 cm/6"



Ai 24-7156-21
21 cm/8¼"



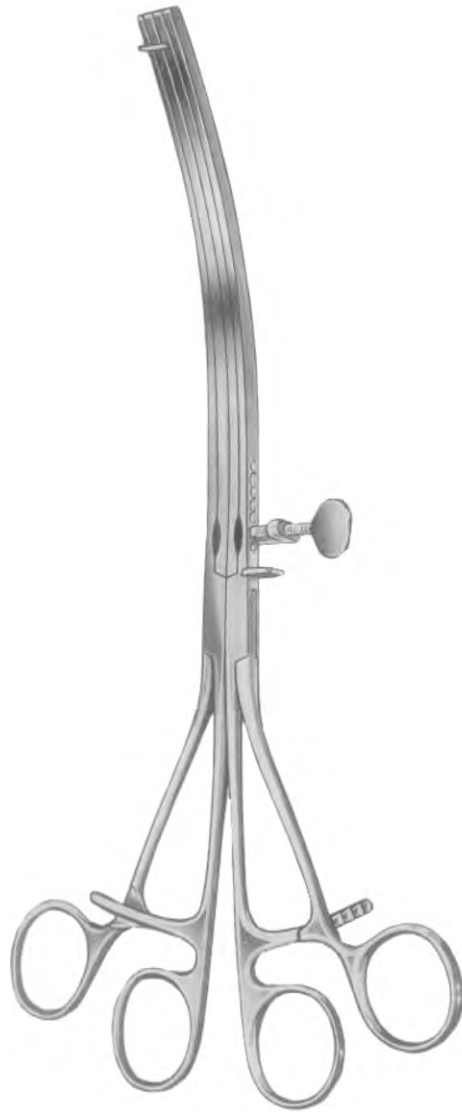
Ai 24-7157-29
29 cm/11½"



Ai 24-7158-35
35 cm/13¾"



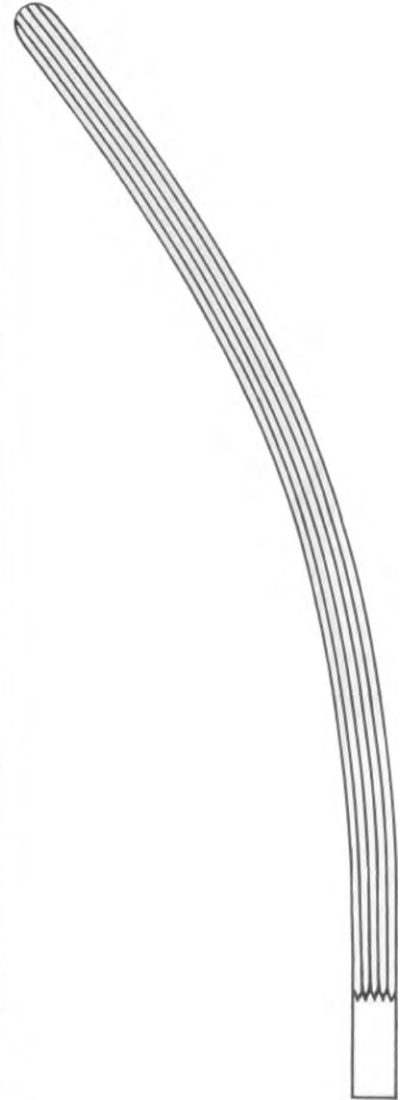
Lane
30 cm/12"



Twin Clamps Forceps

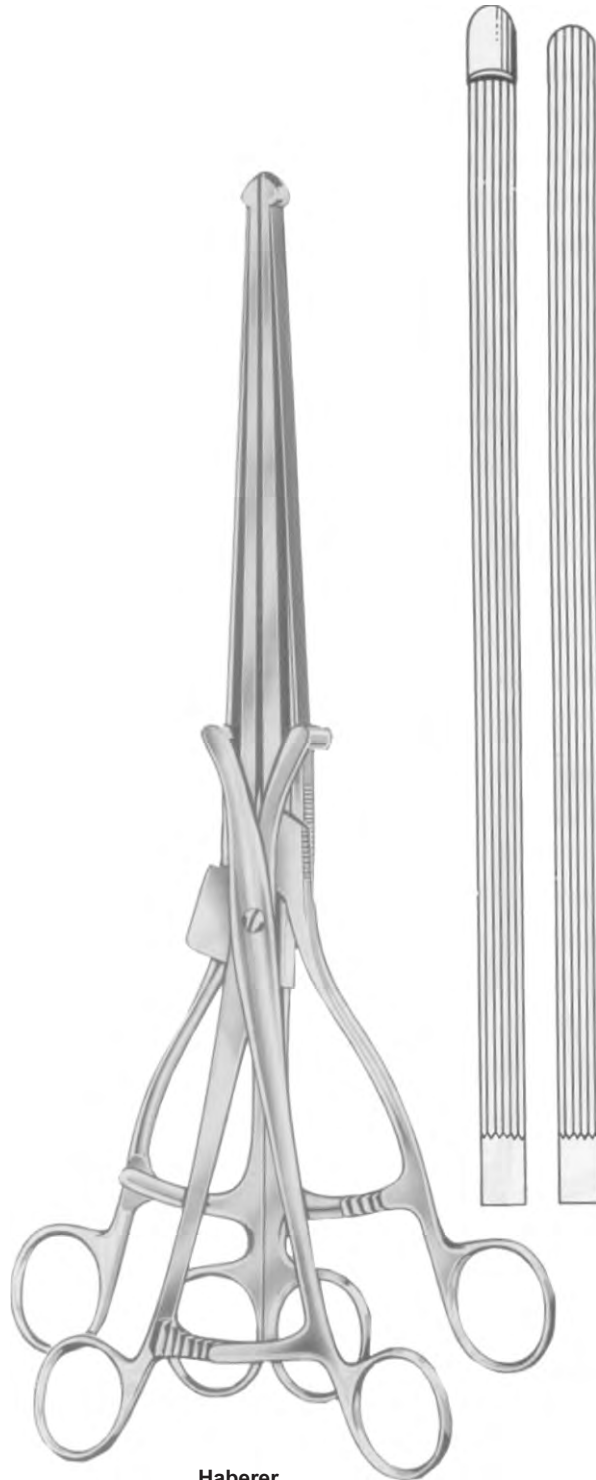


Straight
Ai 24-7159-30

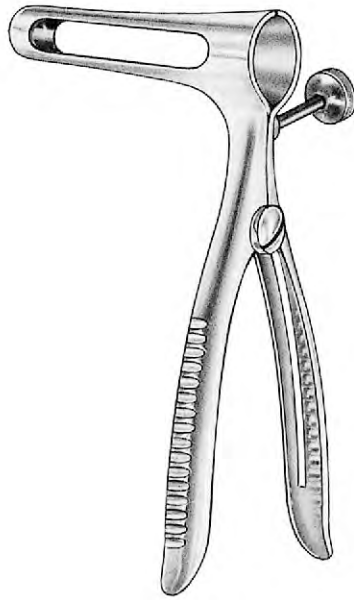


Curved
Ai 24-7160-30

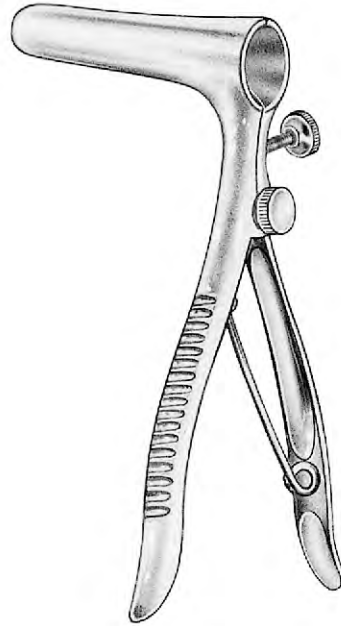




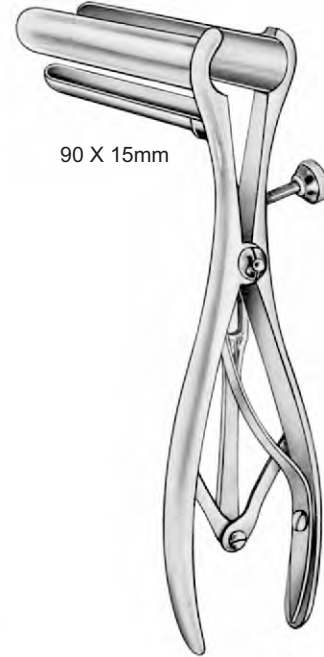
Haberer
Ai 24-7161-36
36 cm/14"



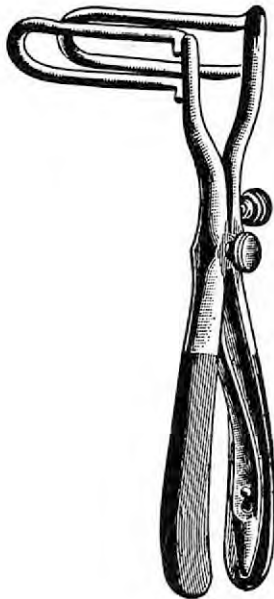
SIMS
 Ai 24-7162-15
 15.0cm



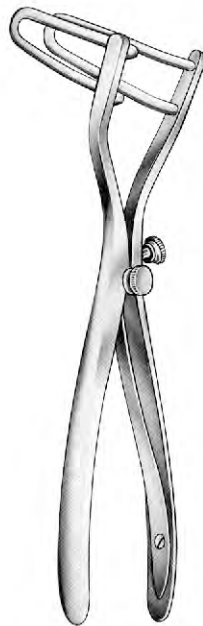
SIMS
 Ai 24-7163-15
 15.0cm



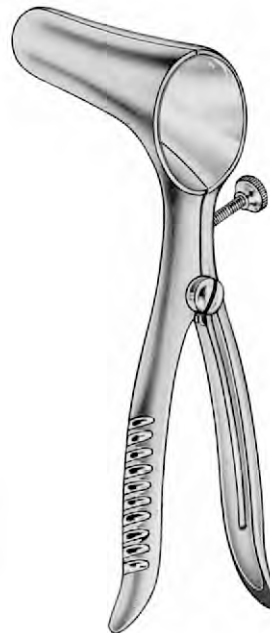
MATHIEU
 Ai 24-7164-19
 19.5cm



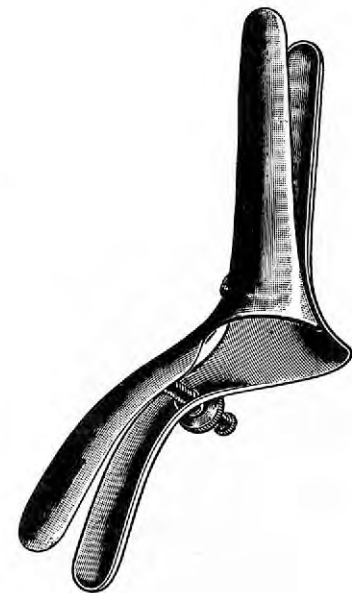
SIMS
 Ai 24-7165-15
 15.0cm



SCHULZE-BERGMANN
 22.0cm
 Ai 24-7166-06 60mm
 Ai 24-7166-08 80mm
 Ai 24-7166-12 125mm
 Ai 24-7166-15 150mm



PRATT
 Ai 24-7167-21
 21.5cm

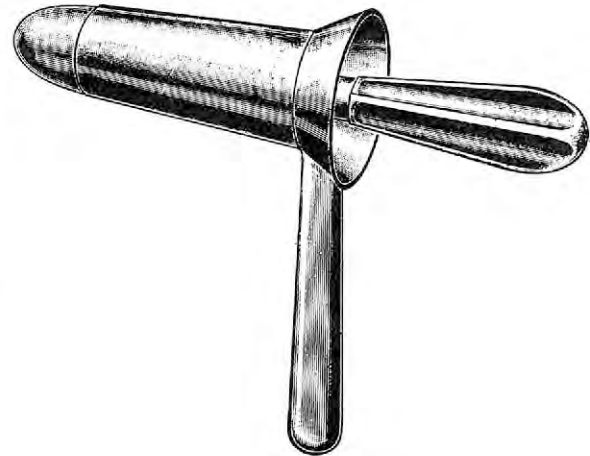


RICORD
 Ai 24-7168-00

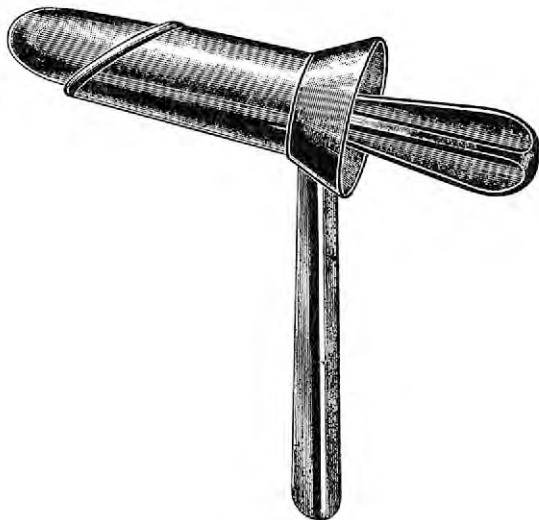


**KELLY**

Ai 24-7169-01 21mm Ø x 50mm
 Ai 24-7169-02 27mm Ø x 50mm

**KELLY**

Ai 24-7170-01 25mm Ø x 64mm
 Ai 24-7170-02 22mm Ø x 35mm

**GRAEME-ANDERSON**

Ai 24-7171-00
 24mm Ø x 64mm

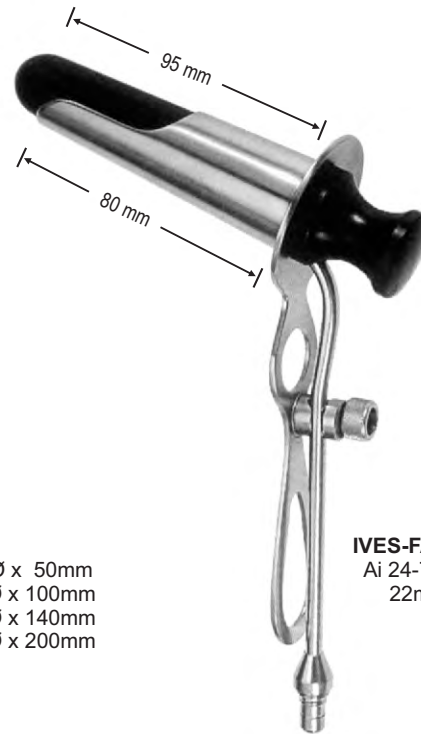
**GABRIEL**

Ai 24-7172-01 24mm Ø x 64mm
 Ai 24-7172-02 19mm Ø x 49mm



KELLY

- Ai 24-7173-01 22mm Ø x 50mm
- Ai 24-7173-02 22mm Ø x 100mm
- Ai 24-7173-03 22mm Ø x 140mm
- Ai 24-7173-04 22mm Ø x 200mm



IVES-FANSLER

- Ai 24-7174-15
22mm Ø



HIRSCHMANN

- Ai 24-7175-01 16mm Ø x 65mm
- Ai 24-7175-02 19mm Ø x 65mm
- Ai 24-7175-03 22mm Ø x 65mm



KELLY

- Ai 24-7176-01 22mm Ø x 50mm
- Ai 24-7176-02 22mm Ø x 100mm
- Ai 24-7176-03 22mm Ø x 140mm





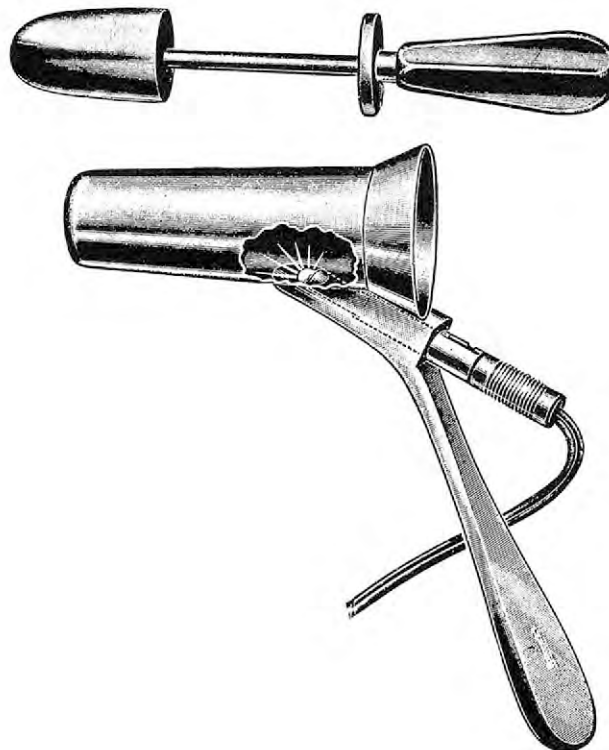
MOD. MARTIN
 Ai 24-7177-01 22mm Ø X 50mm
 Ai 24-7177-02 22mm Ø X 75mm
 Ai 24-7177-03 22mm Ø X 100mm



NEWMAN
 Ai 24-7178-01 16mm Ø X 63mm
 Ai 24-7178-02 19mm Ø X 63mm
 Ai 24-7178-03 23mm Ø X 63mm



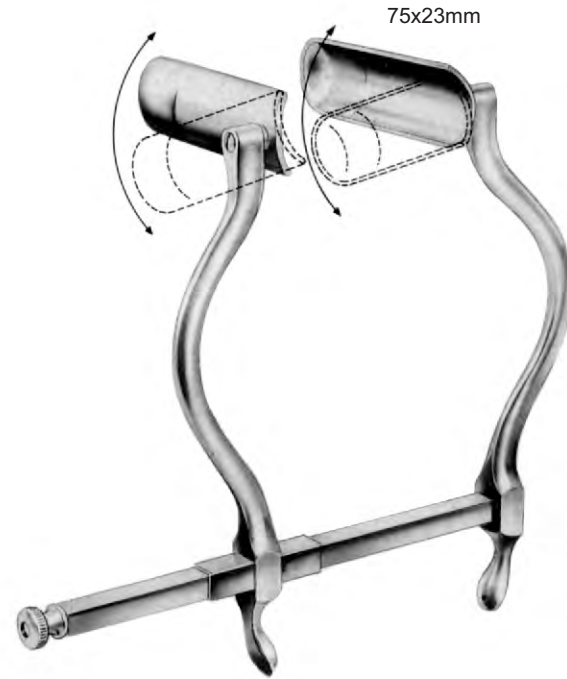
BENSAUDE
 Ai 24-7179-01 19mmØ X 70mm
 Ai 24-7179-02 22mmØ X 70mm



NAUNTON-MORGAN
 Ai 24-7180-00
 22mmØ X 70mm



BARR
 Ai 24-7181-17
 17.0cm



SMITH-BUIE
 Ai 24-7182-15
 15.0cm



ALAN PARKS
 13.5cm
 Ai 24-7183-00 complete
 Ai 24-7183-04 centre blade
 Ai 24-7183-13 frame only



Ai 24-7183-01
 72mm

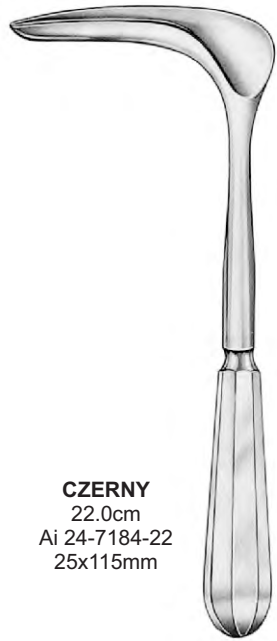


Ai 24-7183-02
 90mm



Ai 24-7183-03
 94mm

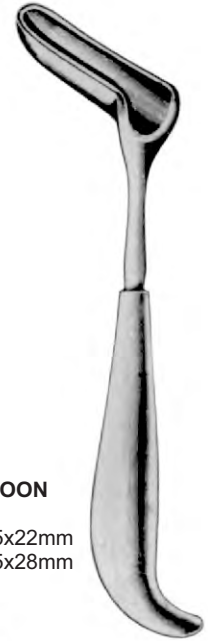




CZERNY
22.0cm
Ai 24-7184-22
25x115mm



SAWYER
23.0cm
Ai 24-7185-01 65x22mm
Ai 24-7185-02 75x28mm
Ai 24-7185-03 90x38mm



FERGUSON-MOON
21.0cm
Ai 24-7186-01 65x22mm
Ai 24-7186-02 75x28mm



BUIE
13.5cm
Ai 24-7187-13 light
Ai 24-7188-13 heavy



LARRY
Ai 24-7189-18
18.0cm



ROSER
Ai 24-7190-17
17.0cm



PRATT
22.0cm



Ai 24-7191-01



Ai 24-7191-02



Ai 24-7191-03



BARR
Ai 24-7192-23
23.0cm



BARR
Ai 24-7193-14
14.0cm

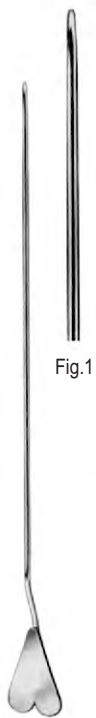


Fig.1

Ai 24-7194-01
Fig.1 straight



Fig.2

Ai 24-7194-02
Fig.2 45° curved

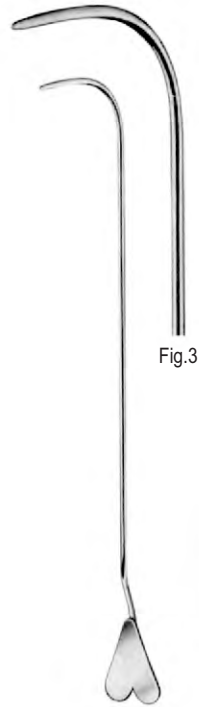


Fig.3

Ai 24-7194-03
Fig.3 90° curved



Fig.4

Ai 24-7194-04
Fig.4 retrograde curved

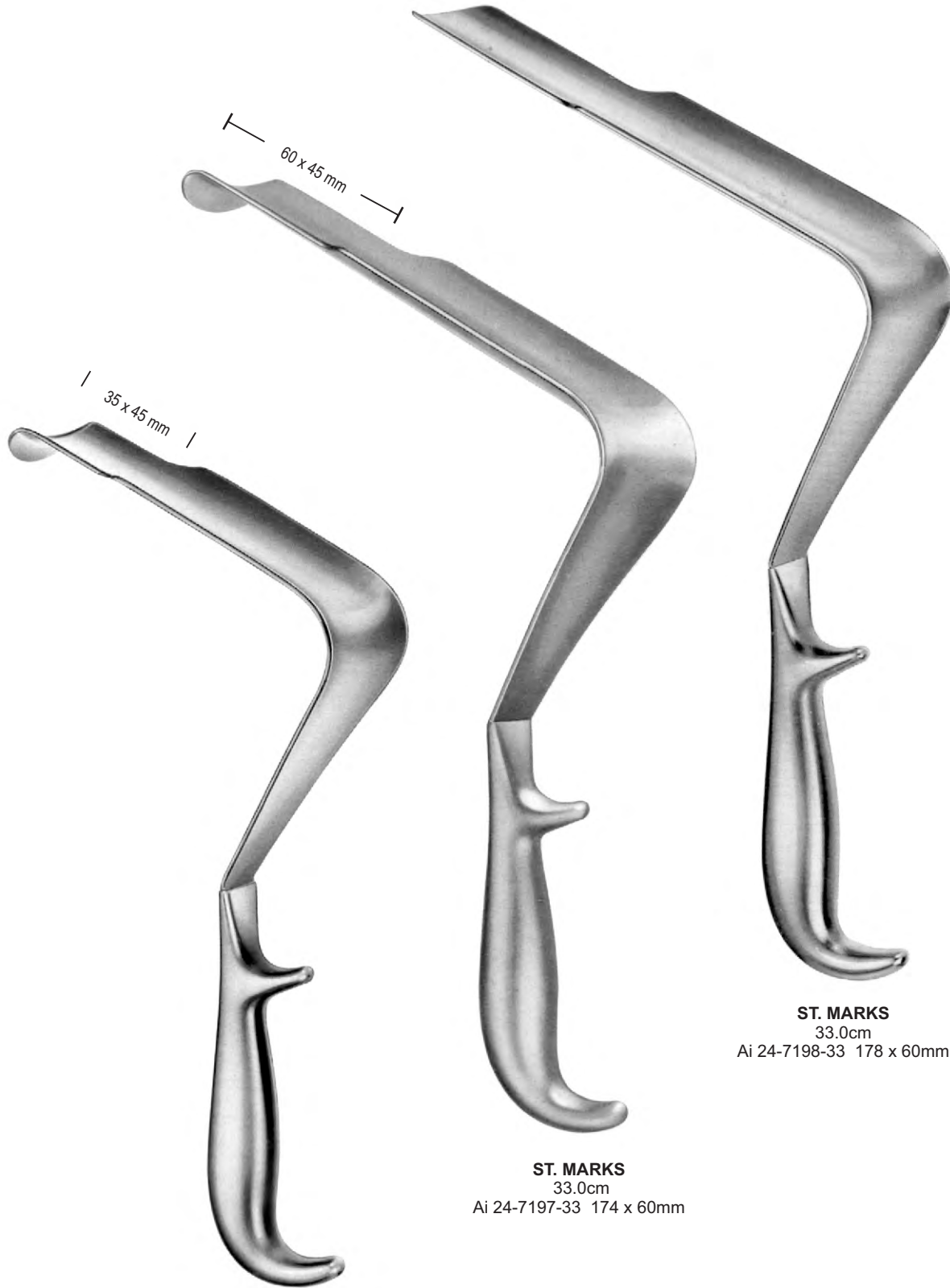


tip
3.5mm Ø

BRODIE
20.0cm
Ai 24-7195-20

LOCKHART-MUMMERY
16.5cm

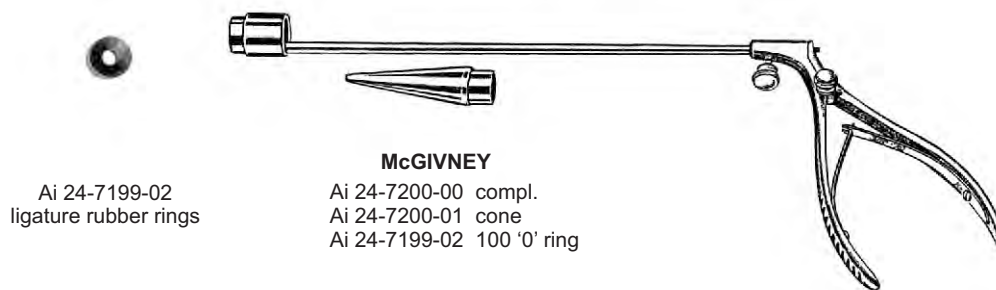




ST. MARKS
29.0cm
Ai 24-7196-29 124x60mm

ST. MARKS
33.0cm
Ai 24-7197-33 174 x 60mm

ST. MARKS
33.0cm
Ai 24-7198-33 178 x 60mm

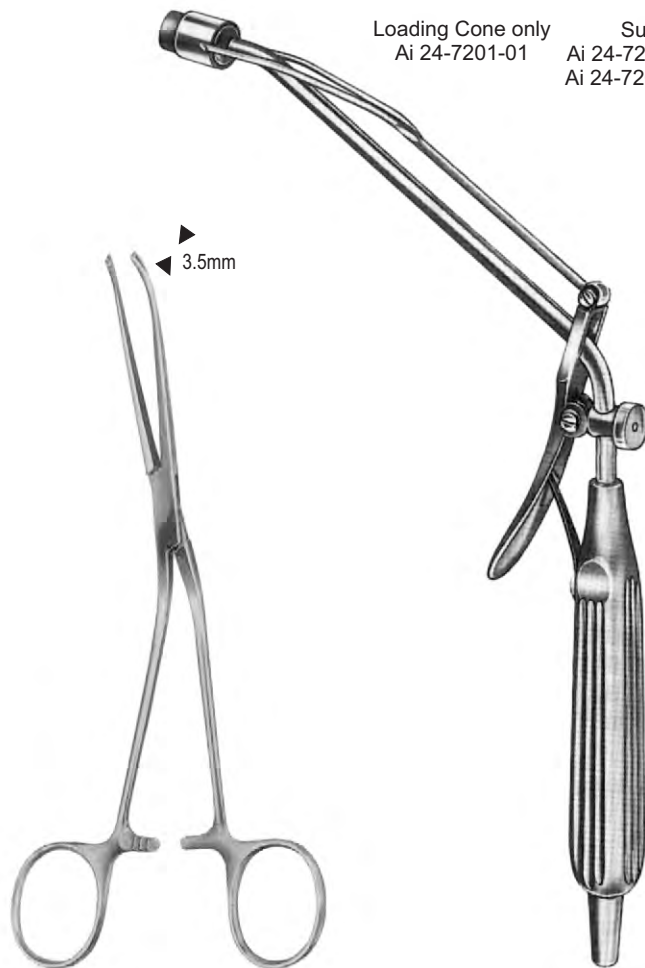


Ai 24-7199-02
 ligature rubber rings

McGIVNEY
 Ai 24-7200-00 compl.
 Ai 24-7200-01 cone
 Ai 24-7199-02 100 '0' ring



Loading Cone only Ai 24-7201-01 Suction Head
 Ai 24-7201-11 10x11mm
 Ai 24-7201-16 10x16mm



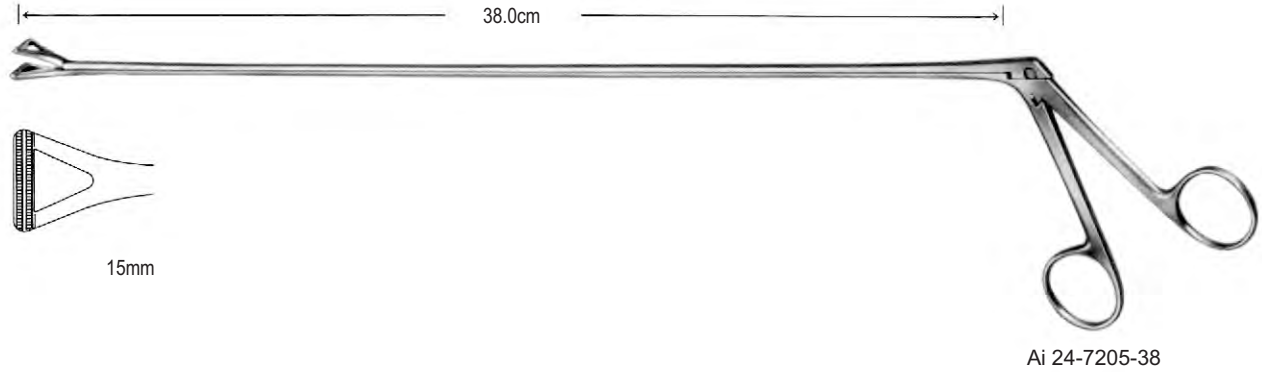
McGIVNEY
 Ai 24-7202-18
 18.5cm

18.5cm
 Ai 24-7203-00 Set
 Ai 24-7201-01 Cone
 Ai 24-7201-11 Suction Head
 Ai 24-7201-16 Suction Head
 Ai 24-7199-02 100 '0' ring

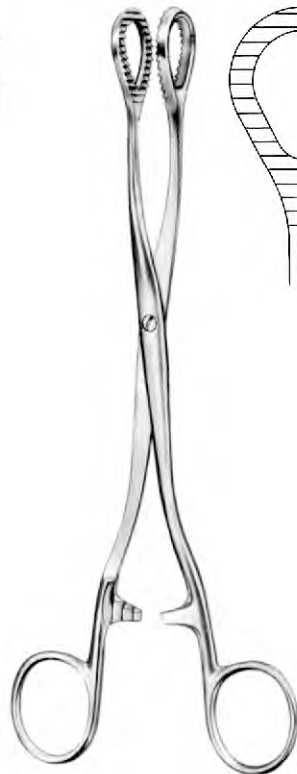
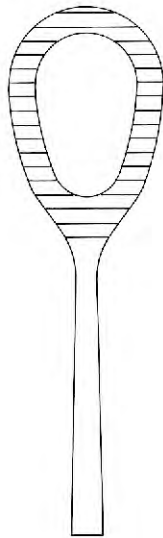


RUDD
 Ai 24-7204-31 31.5cm
 Ai 24-7201-01 cone
 Ai 24-7199-02 100 '0' ring

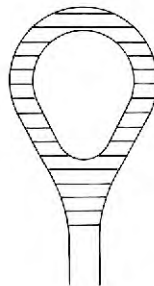




HEYWOOD-SMITH
 Ai 24-7206-21
 21.0cm

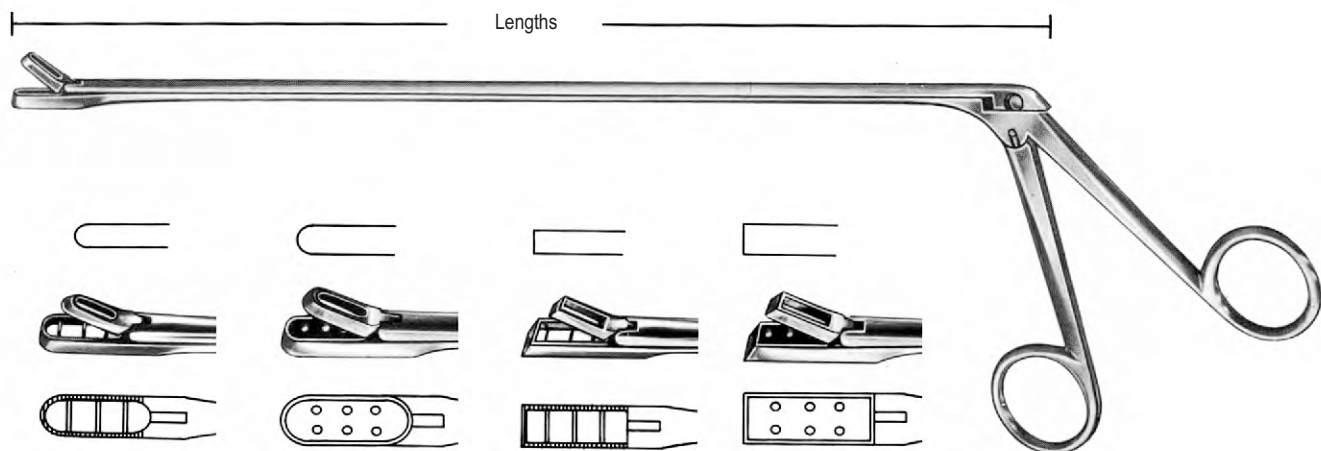
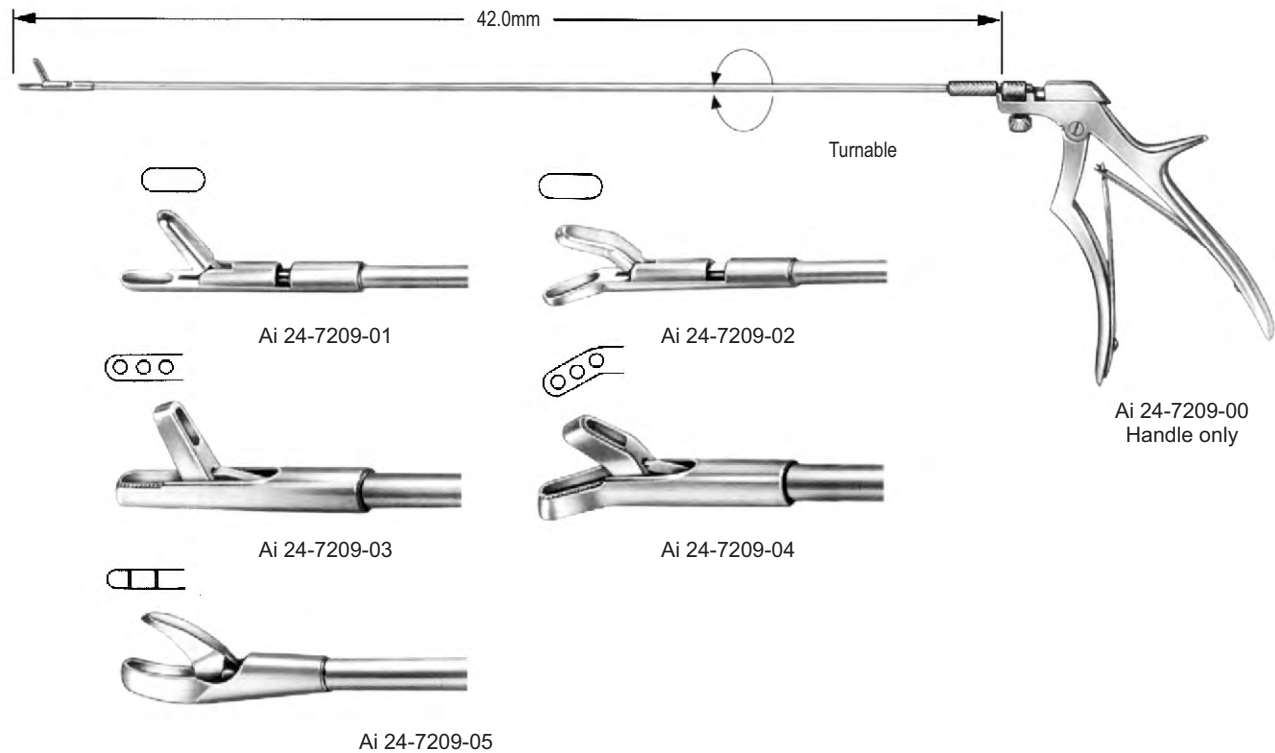


HEYWOOD-SMITH
 Ai 24-7207-20
 20.0cm



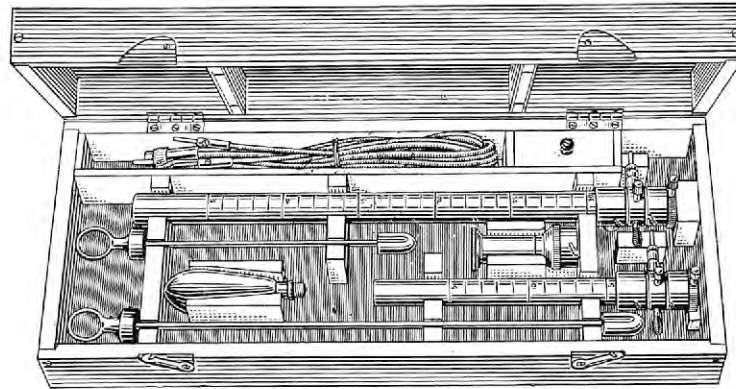
LUER
 Ai 24-7208-24
 24.5cm



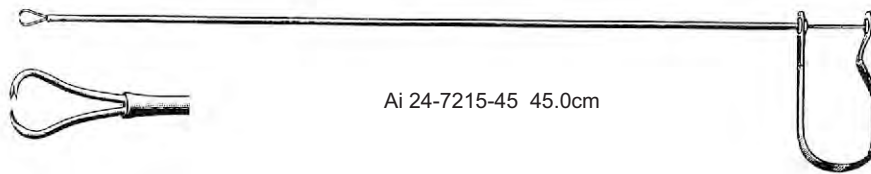


L/shaft	Ai 24-7210-28	Ai 24-7211-28	Ai 24-7212-28	Ai 24-7213-28
28.0cm	Ai 24-7210-28	Ai 24-7211-28	Ai 24-7212-28	Ai 24-7213-28
35.0cm	Ai 24-7210-35	Ai 24-7211-35	Ai 24-7212-35	Ai 24-7213-35
42.0cm	Ai 24-7210-42	Ai 24-7211-42	Ai 24-7212-42	Ai 24-7213-42

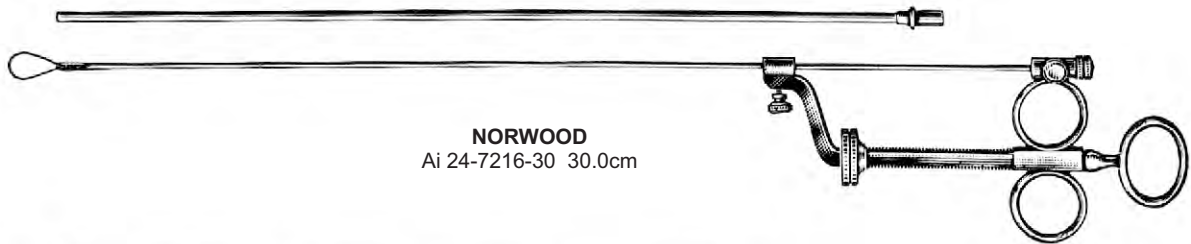




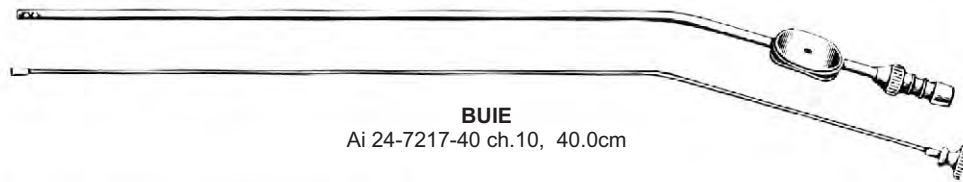
LLOYDS-DAVIES
 Ai 24-7214-00 complete



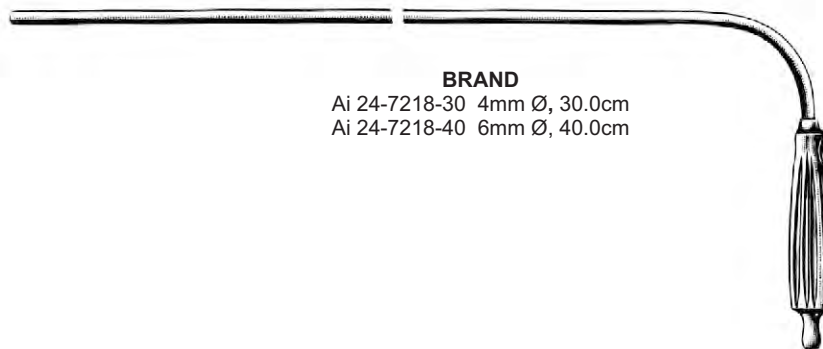
Ai 24-7215-45 45.0cm



NORWOOD
 Ai 24-7216-30 30.0cm



BUIE
 Ai 24-7217-40 ch.10, 40.0cm



BRAND
 Ai 24-7218-30 4mm Ø, 30.0cm
 Ai 24-7218-40 6mm Ø, 40.0cm



EN Kidney, Liver, Gall Stone, Urology

DE Niere, Leber, Galle, Urologie

ES Riñón, Hígado, Bilis, Urología

Page 620 to 638

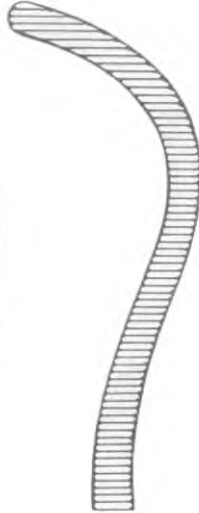




Guyon



Ai 25-7301-20
20 cm/8"



Ai 25-7301-22
22 cm/8¾"



Ai 25-7301-24
24 cm/9½"

Atrauma



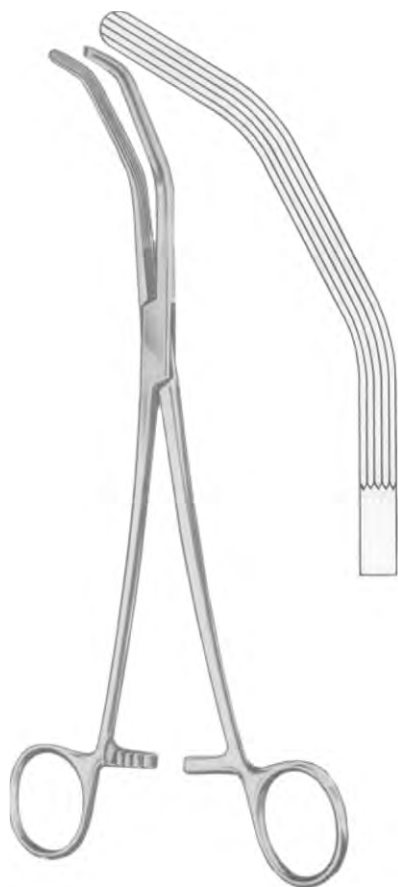
Ai 25-7302-23
23 cm/9"



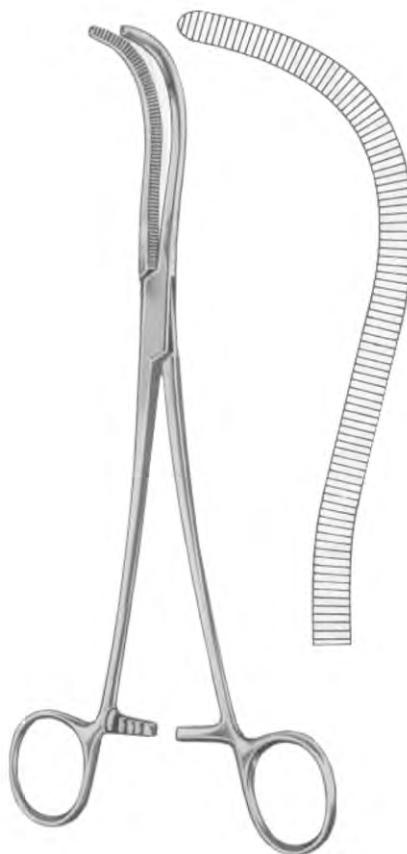
Ai 25-7302-24
24 cm/9½"



Guyon
 Ai 25-7303-23
 23 cm/9"



Herrick
Ai 25-7304-23
23 cm/9"



Mayo-Guyon
Ai 25-7305-23
23 cm/9"



Stille
Ai 25-7306-23
23 cm/9"

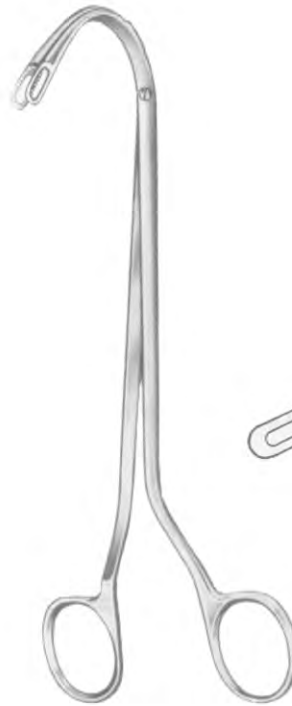




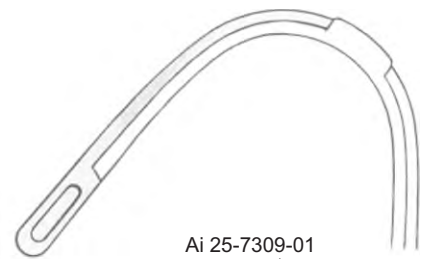
Elsasser
 Ai 25-7307-20
 20 cm/8"



Ai 25-7308-20
 20 cm/8"



Randall



Ai 25-7309-01
 19 cm/7½"



Ai 25-7309-02
 19 cm/7½"



Randall

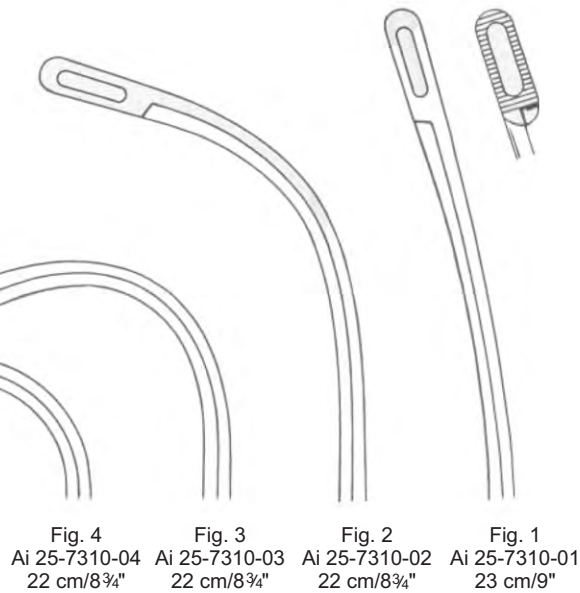
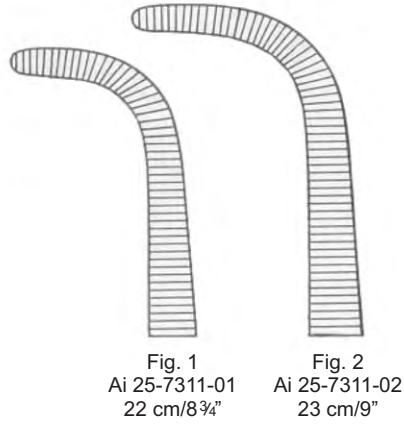
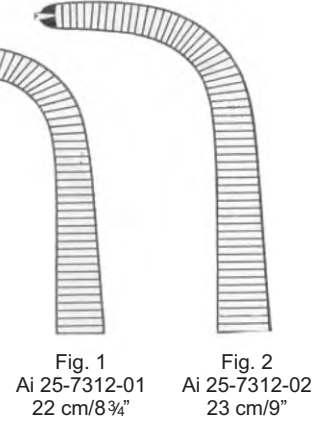


Fig. 4 Ai 25-7310-04 22 cm/8¾"
 Fig. 3 Ai 25-7310-03 22 cm/8¾"
 Fig. 2 Ai 25-7310-02 22 cm/8¾"
 Fig. 1 Ai 25-7310-01 23 cm/9"

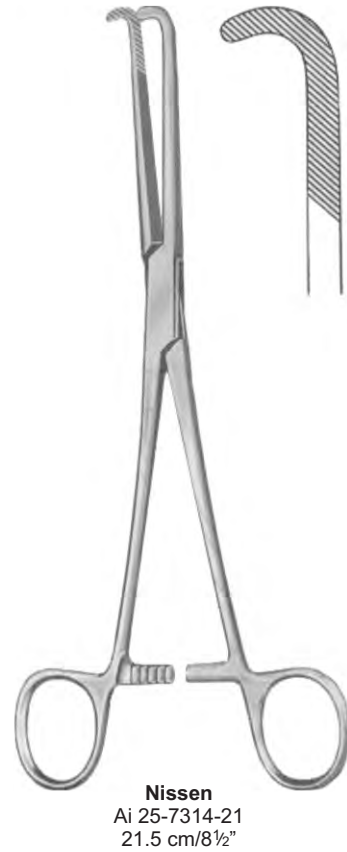


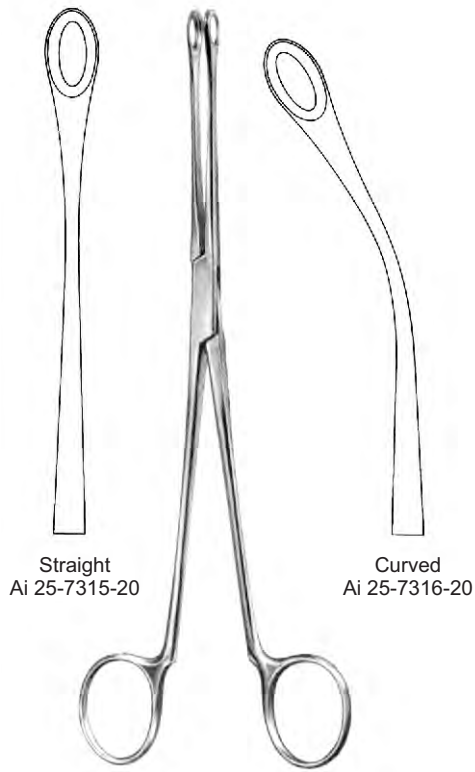
Set of 2 pieces



Set of 2 pieces

Gall duct and
 cystic forceps





Blake
20 cm/8"



Mayo-Blake
20 cm/8"



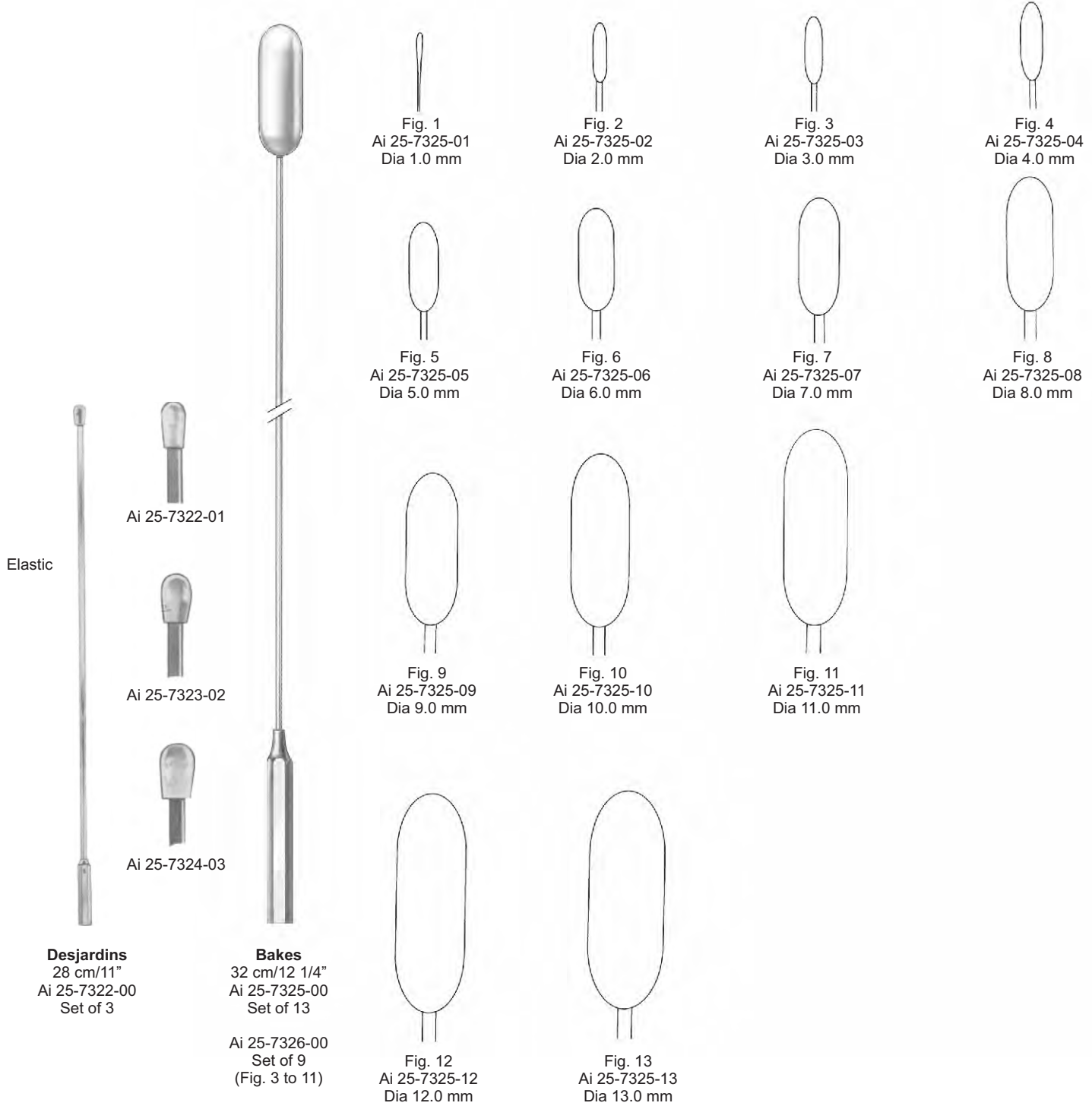
Mayo-Blake
20 cm/8"



Czerny
Ai 25-7319-24
24.5 cm/9¾"



Desjardins
23 cm/9"





Elastic



Desjardins
30 cm/12"
Ai 25-7327-00
Set of 4



Fig.1
Ai 25-7327-01



Fig.2
Ai 25-7327-02



Fig.3
Ai 25-7327-03



Fig.4
Ai 25-7327-04

Malleable



Luer-Koerte
32 cm/12½"
Ai 25-7328-00
Set of 8



Ai 25-7328-02
2.5 mm



Ai 25-7328-06
6.7 mm



Ai 25-7328-03
3.2 mm



Ai 25-7328-08
8.0 mm



Ai 25-7328-04
4.2 mm



Ai 25-7328-11
11 mm



Ai 25-7328-05
5.5 mm



Ai 25-7328-15
15 mm



Mayo
Ai 25-7329-28
28 cm/11"

Malleable



Mayo
26.5 cm/10½"



Fig. 1
Ai 25-7330-01



Fig. 2
Ai 25-7330-02



Fig. 3
Ai 25-7330-03



Moore
26-8506-28
28 cm/11"

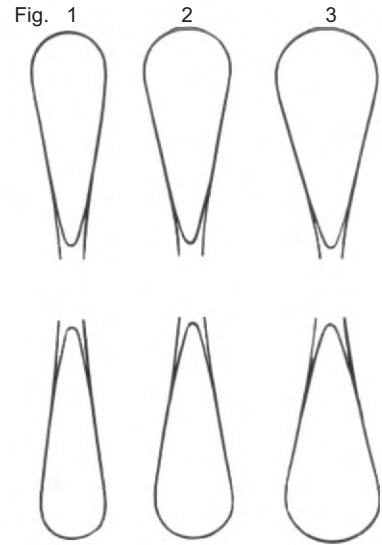
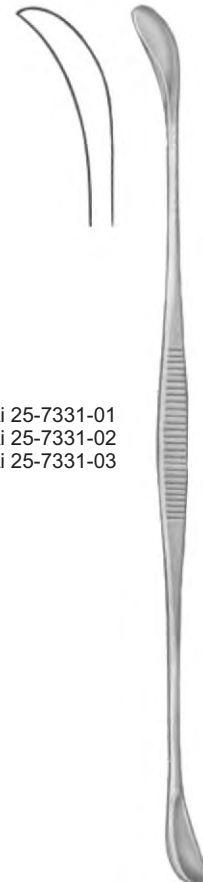


Fig.
1 Ai 25-7331-01
2 Ai 25-7331-02
3 Ai 25-7331-03



Fergusson
24 cm/9½"





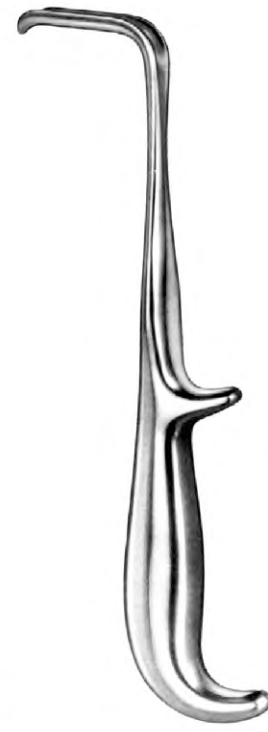
Young
 Ai 25-7332-22
 22 cm/8¾"



Young
 Ai 25-7333-21
 21 cm/8¼"



Young
 Ai 25-7334-22
 22 cm/8¾"



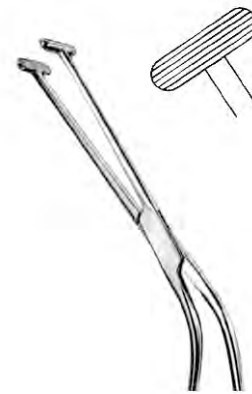
Young
 Ai 25-7335-21
 21 cm/8¼"



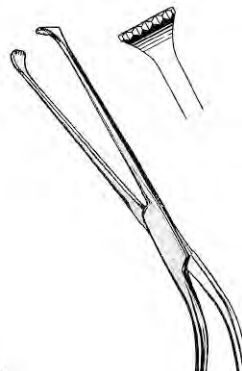
MILLIN
 Ai 25-7336-01
 24.5cm



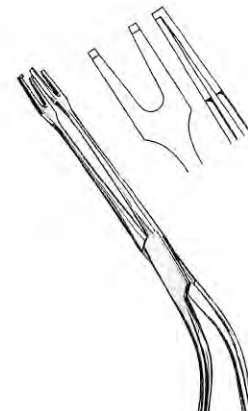
Ai 25-7336-02 23.5cm



Ai 25-7336-03 23.0cm



Ai 25-7336-04 23.0cm



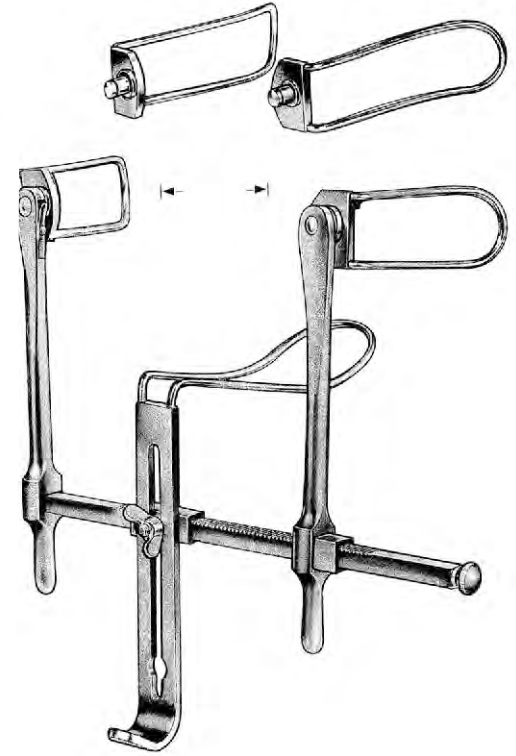
Ai 25-7336-05 24.0cm



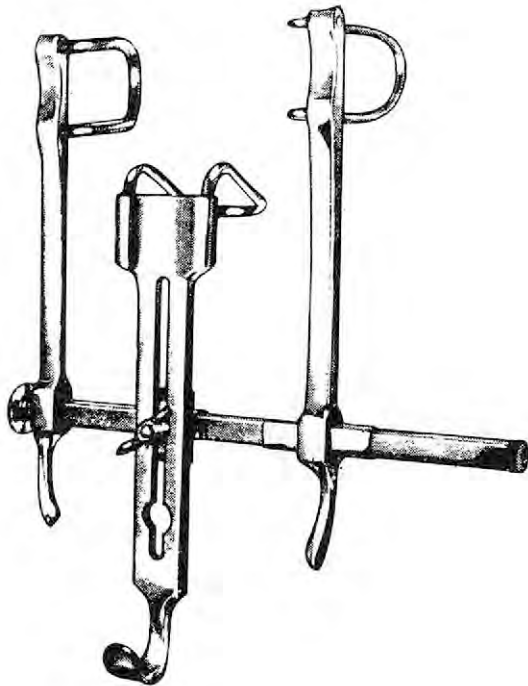
Millin
 Ai 25-7339-00



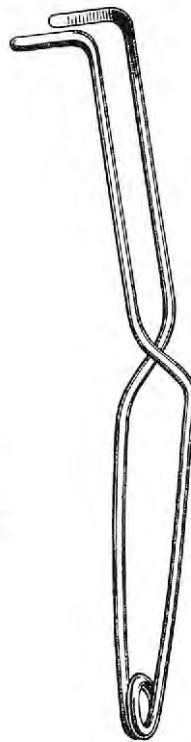
Legueu
 Ai 25-7340-00



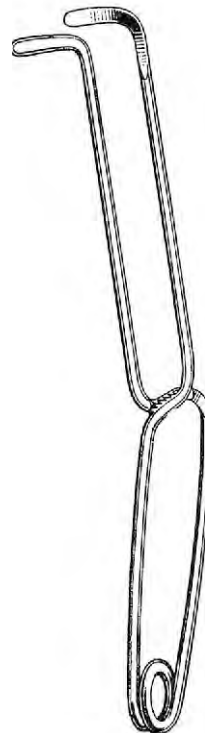
Gosset
 Ai 25-7341-00



Pantings
 Ai 25-7342-00



Millin
 Ai 25-7342-01
 24 cm/9½"

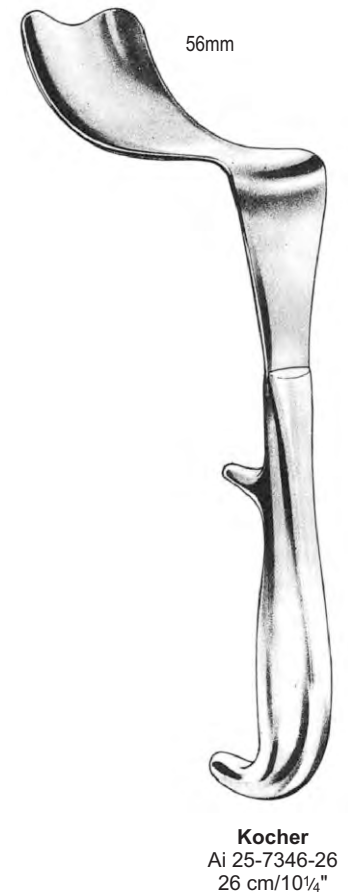
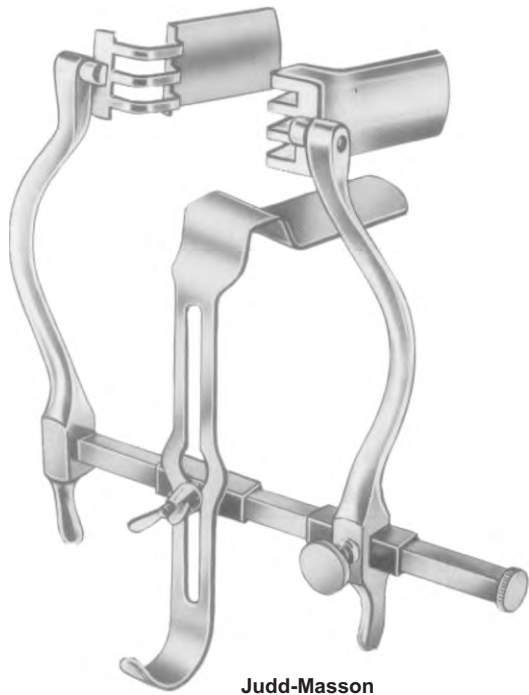


Millin
 Ai 25-7342-02
 24 cm/9½"



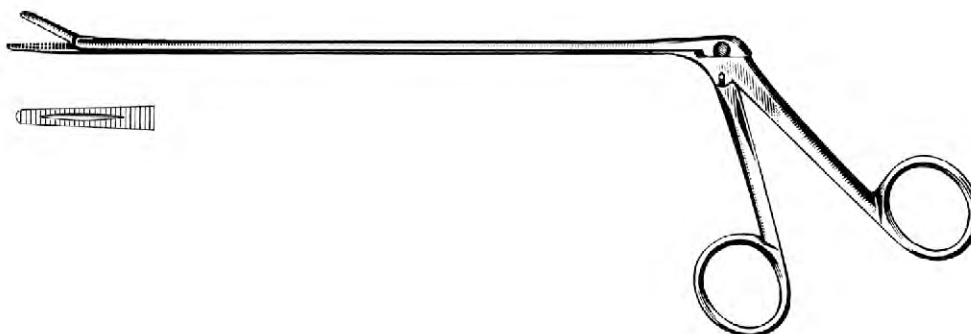
Millin
 Ai 25-7342-03
 24 cm/9½"



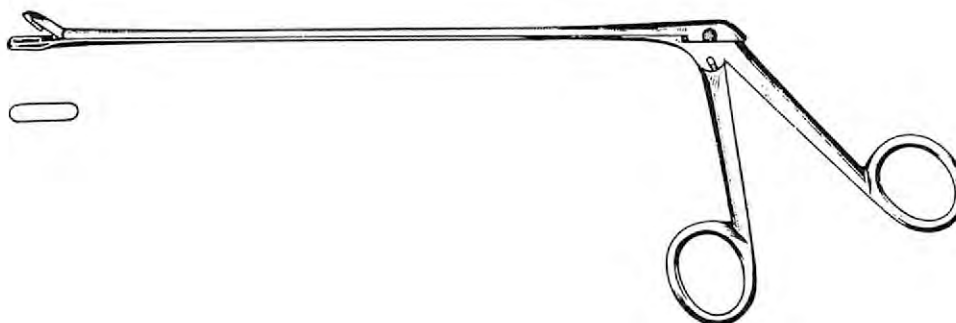




SACHSE
 Ai 25-7347-12



MATHIEU
 Ai 25-7348-20 20.0cm
 Ai 25-7348-28 28.0cm



MATHIEU
 Ai 25-7349-20 20.0cm
 Ai 25-7349-28 28.0cm





STOCKMANN
 Ai 25-7350-08



ZIESER MEAEUS CLAMP
 Ai 25-7351-10
 10.0cm



STRAUSS
 Ai 25-7352-11



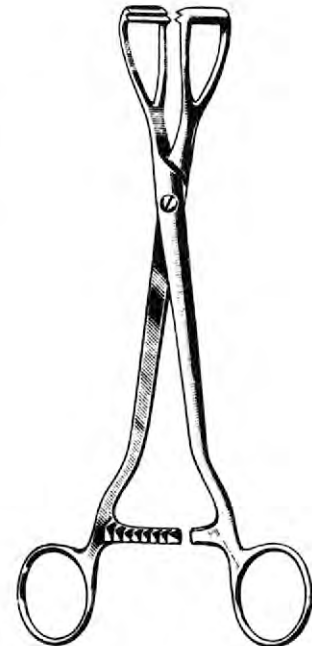
THOMSON-WALKER
 Ai 25-7353-00



LEWKOWITZ
 Ai 25-7354-26
 26.0cm



Ai 25-7355-26



YOUNG
 Ai 25-7356-20
 20.0cm



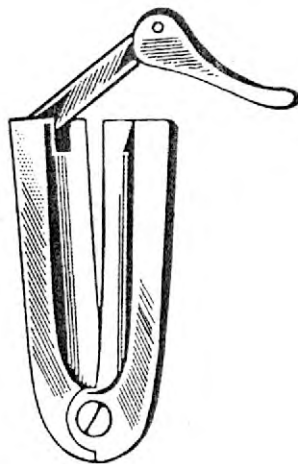
GAMCO

- Ai 25-7357-08 8mm Ø, baby size
- Ai 25-7357-11 11mm Ø, child size
- Ai 25-7357-13 13mm Ø, child size
- Ai 25-7357-16 16mm Ø, adolescent size
- Ai 25-7357-21 21mm Ø, adolescent size
- Ai 25-7357-26 26mm Ø, men's size
- Ai 25-7357-32 32mm Ø, men's size



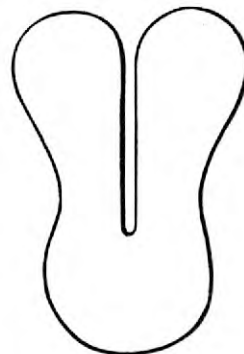
WINKELMANN

- Ai 25-7358-12 12mm Ø
- Ai 25-7358-16 16mm Ø
- Ai 25-7358-20 20mm Ø



MOGEN

- Ai 25-7359-00
- 58.0162.00



CIRCUMCISION SHIELD

- Ai 25-7360-10
- 10.0cm



CIRCUMCISION PROBE

- Ai 25-7361-15
- 15.0cm

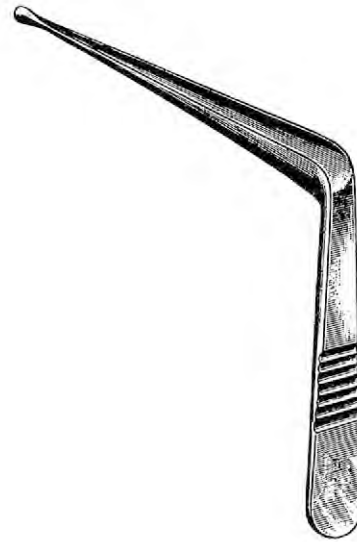




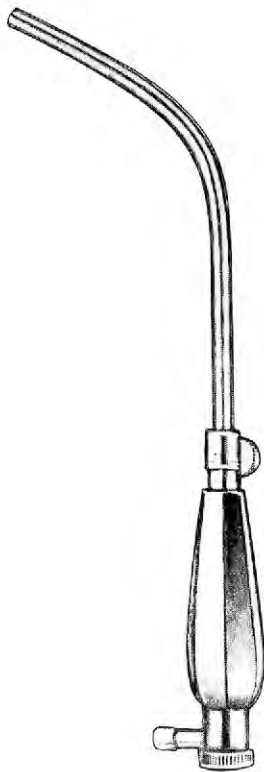
CHILD
 Ai 25-7362-00



KEY
 Ai 25-7363-00



TEALE
 Ai 25-7364-00



MILLIN
 Ai 25-7365-00

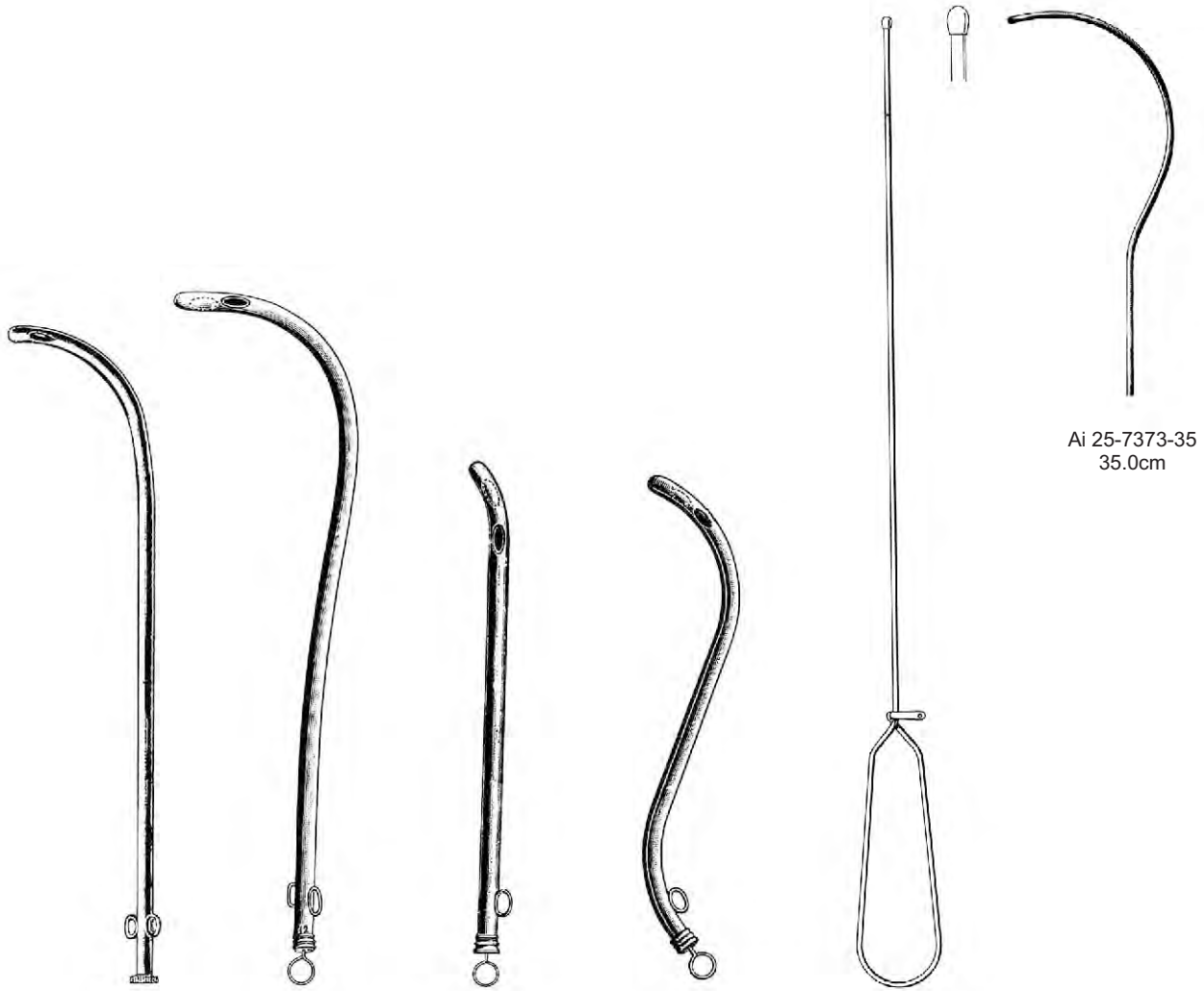


CORD HOOK
 Ai 25-7366-16
 16.0cm



GUTTMANN
 Ai 25-7367-26
 26.0cm





Ai 25-7373-35
 35.0cm

Ai 25-7372-39
 39.0cm

F.G.	COXETER		FEMALE 15.0cm	MALE 20.0cm
	MALE 27.0cm	28.0cm		
6	Ai 25-7368-06	Ai 25-7369-06	Ai 25-7370-06	Ai 25-7371-06
8	Ai 25-7368-08	Ai 25-7369-08	Ai 25-7370-08	Ai 25-7371-08
10	Ai 25-7368-10	Ai 25-7369-10	Ai 25-7370-10	Ai 25-7371-10
12	Ai 25-7368-12	Ai 25-7369-12	Ai 25-7370-12	Ai 25-7371-12
14	Ai 25-7368-14	Ai 25-7369-14	Ai 25-7370-14	Ai 25-7371-14
16	Ai 25-7368-16	Ai 25-7369-16	Ai 25-7370-16	Ai 25-7371-16
18	Ai 25-7368-18	Ai 25-7369-18	Ai 25-7370-18	Ai 25-7371-18
20	Ai 25-7368-20	Ai 25-7369-20	Ai 25-7370-20	Ai 25-7371-20
22	Ai 25-7368-22	Ai 25-7369-22	Ai 25-7370-22	Ai 25-7371-22
24	Ai 25-7368-24	Ai 25-7369-24	Ai 25-7370-24	Ai 25-7371-24



CLUTTON

- | | |
|-------|---------------|
| set | Ai 25-7374-00 |
| F.G. | |
| 06/10 | Ai 25-7374-06 |
| 08/12 | Ai 25-7374-08 |
| 10/14 | Ai 25-7374-10 |
| 12/16 | Ai 25-7374-12 |
| 14/18 | Ai 25-7374-14 |
| 16/20 | Ai 25-7374-16 |
| 18/22 | Ai 25-7374-18 |
| 20/24 | Ai 25-7374-20 |
| 22/26 | Ai 25-7374-22 |
| 24/28 | Ai 25-7374-24 |
| 26/30 | Ai 25-7374-26 |
| 28/32 | Ai 25-7374-28 |



LISTER

- | | |
|-------|---------------|
| set | Ai 25-7375-00 |
| F.G. | |
| 00/1 | Ai 25-7375-01 |
| 0/2 | Ai 25-7375-02 |
| 1/3 | Ai 25-7375-03 |
| 1/4 | Ai 25-7375-04 |
| 2/5 | Ai 25-7375-05 |
| 3/6 | Ai 25-7375-06 |
| 4/7 | Ai 25-7375-07 |
| 5/8 | Ai 25-7375-08 |
| 6/9 | Ai 25-7375-09 |
| 7/10 | Ai 25-7375-10 |
| 8/11 | Ai 25-7375-11 |
| 9/12 | Ai 25-7375-12 |
| 10/13 | Ai 25-7375-13 |
| 11/14 | Ai 25-7375-14 |
| 12/15 | Ai 25-7375-15 |
| 13/16 | Ai 25-7375-16 |
| 14/17 | Ai 25-7375-17 |
| 15/18 | Ai 25-7375-18 |



F.G.

- | | |
|----|---------------|
| 06 | Ai 25-7376-06 |
| 08 | Ai 25-7376-08 |
| 10 | Ai 25-7376-10 |
| 12 | Ai 25-7376-12 |
| 14 | Ai 25-7376-14 |
| 16 | Ai 25-7376-16 |

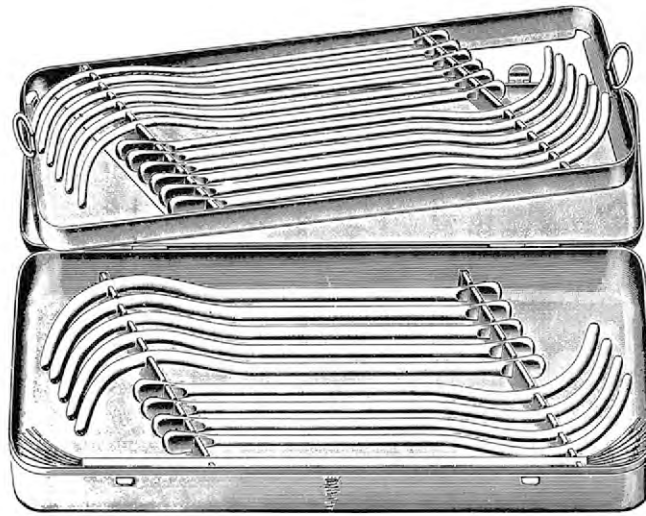


WHEELHOUSE
 Ai 25-7377-00



	VAN BUREN	GUYON	GUYON	DITTEL	DITTEL
	Ai 25-7378-00 set No. 8-36	Ai 25-7379-00 set No. 10-30	Ai 25-7380-00 set No. 10-30	Ai 25-7381-00 set No.10-30	Ai 25-7382-00 set No.8-30
(French)					
8	Ai 25-7378-08				Ai 25-7382-08
9					Ai 25-7382-09
10	Ai 25-7378-10	Ai 25-7379-10	Ai 25-7380-10	Ai 25-7381-10	Ai 25-7382-10
11		Ai 25-7379-11	Ai 25-7380-11	Ai 25-7381-11	Ai 25-7382-11
12	Ai 25-7378-12	Ai 25-7379-12	Ai 25-7380-12	Ai 25-7381-12	Ai 25-7382-12
13		Ai 25-7379-13	Ai 25-7380-13	Ai 25-7381-13	Ai 25-7382-13
14	Ai 25-7378-14	Ai 25-7379-14	Ai 25-7380-14	Ai 25-7381-14	Ai 25-7382-14
15		Ai 25-7379-15	Ai 25-7380-15	Ai 25-7381-15	Ai 25-7382-15
16	Ai 25-7378-16	Ai 25-7379-16	Ai 25-7380-16	Ai 25-7381-16	Ai 25-7382-16
17		Ai 25-7379-17	Ai 25-7380-17	Ai 25-7381-17	Ai 25-7382-17
18	Ai 25-7378-18	Ai 25-7379-18	Ai 25-7380-18	Ai 25-7381-18	Ai 25-7382-18
19		Ai 25-7379-19	Ai 25-7380-19	Ai 25-7381-19	Ai 25-7382-19
20	Ai 25-7378-20	Ai 25-7379-20	Ai 25-7380-20	Ai 25-7381-20	Ai 25-7382-20
21		Ai 25-7379-21	Ai 25-7380-21	Ai 25-7381-21	Ai 25-7382-21
22	Ai 25-7378-22	Ai 25-7379-22	Ai 25-7380-22	Ai 25-7381-22	Ai 25-7382-22
23		Ai 25-7379-23	Ai 25-7380-23	Ai 25-7381-23	Ai 25-7382-23
24	Ai 25-7378-24	Ai 25-7379-24	Ai 25-7380-24	Ai 25-7381-24	Ai 25-7382-24
25		Ai 25-7379-25	Ai 25-7380-25	Ai 25-7381-25	Ai 25-7382-25
26	Ai 25-7378-26	Ai 25-7379-26	Ai 25-7380-26	Ai 25-7381-26	Ai 25-7382-26
27		Ai 25-7379-27	Ai 25-7380-27	Ai 25-7381-27	Ai 25-7382-27
28	Ai 25-7378-28	Ai 25-7379-28	Ai 25-7380-28	Ai 25-7381-28	Ai 25-7382-28
29		Ai 25-7379-29	Ai 25-7380-29	Ai 25-7381-29	Ai 25-7382-29
30	Ai 25-7378-30	Ai 25-7379-30	Ai 25-7380-30	Ai 25-7381-30	Ai 25-7382-30
31	Ai 25-7378-31				
32	Ai 25-7378-32				
33	Ai 25-7378-33				
34	Ai 25-7378-34				
35	Ai 25-7378-35				
36	Ai 25-7378-36				





VAN BUREN
 Ai 25-7383-00
 420x175x40 mm
 set in metal case containing
 21 bougies



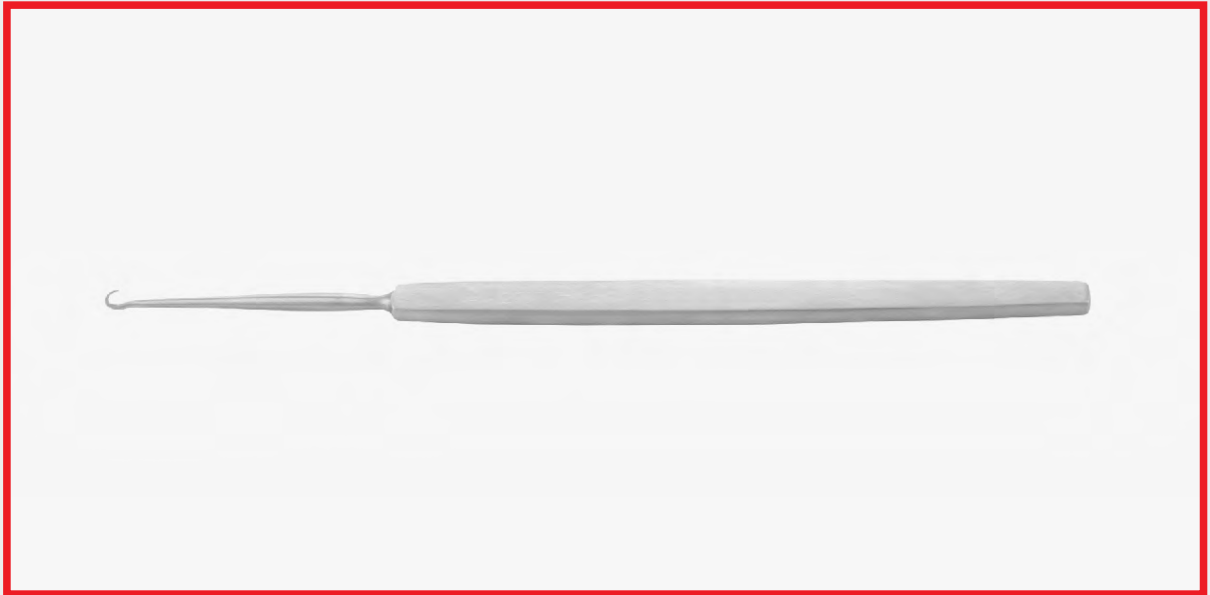
GUYON
 Ai 25-7384-00
 420x175x40mm
 set in metal case containing
 21 bougies
 6 liliform in metal tube

EN Dermatology

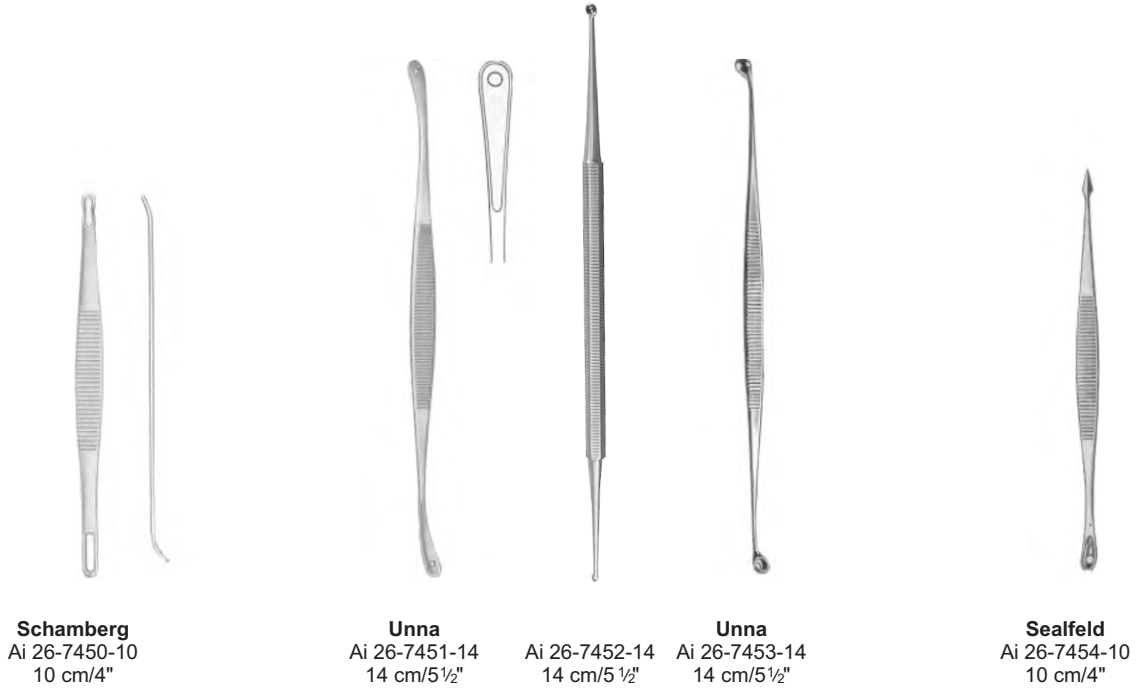
DE Dermatologie

ES Dermatología

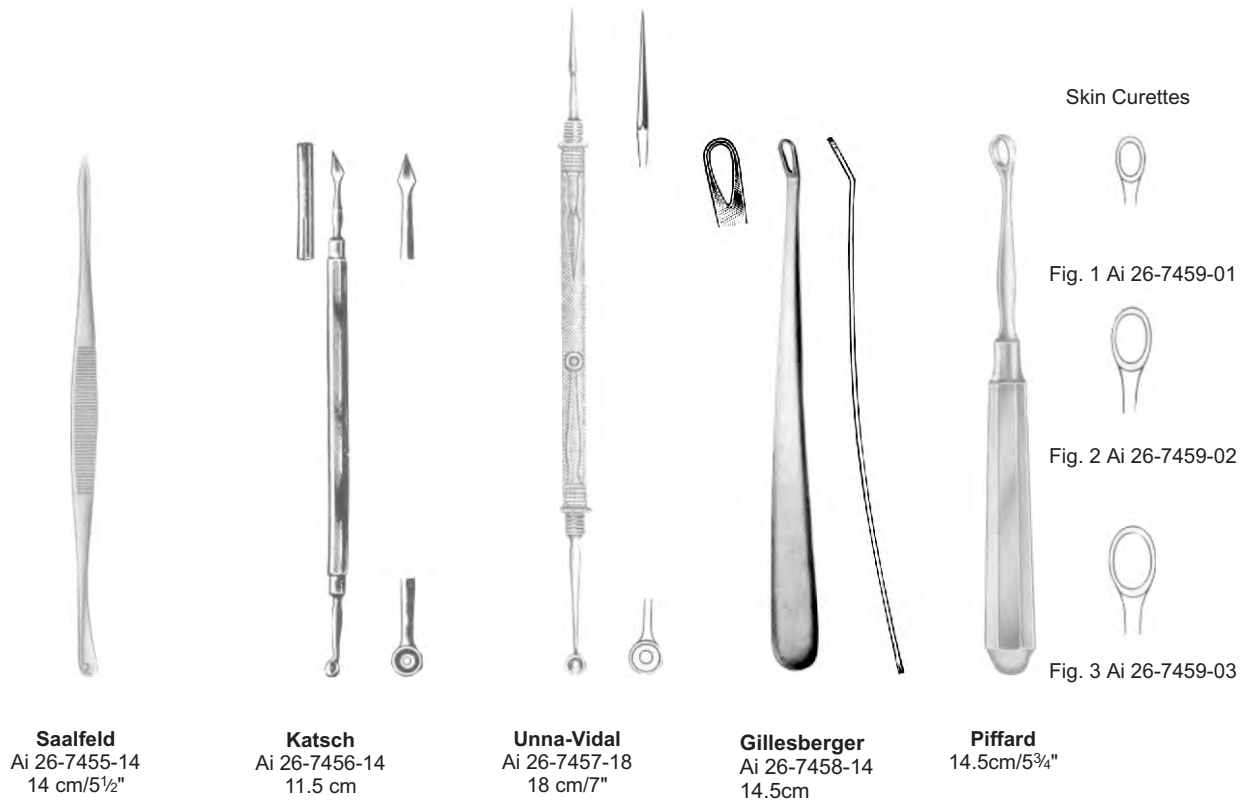
Page 639 to 640



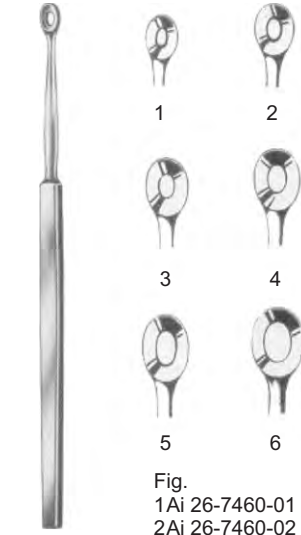
Comedone Extractors



Skin Curettes



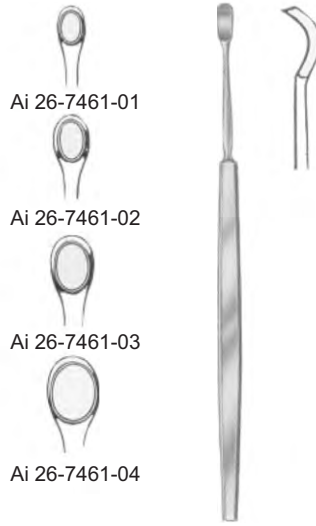
Lupus Currettes



Wolff
 14 cm/5½"

- Fig.
 1 Ai 26-7460-01
 2 Ai 26-7460-02
 3 Ai 26-7460-03
 4 Ai 26-7460-04
 5 Ai 26-7460-05
 6 Ai 26-7460-06

Lupus Currettes Lupus Scraper



Fox
 14 cm/5½"

Vidal
 Ai 26-7462-14
 14 cm/5½"

Moncorps Knife



Moncorps
 Ai 26-7463-14
 14 cm/5½"

Cutaneous Hook



Gillies
 Fig. 1 Ai 26-7464-01
 Fig. 2 Ai 26-7464-02
 18 cm/7"

Kilner
 Ai 26-7465-15
 15 cm/6"

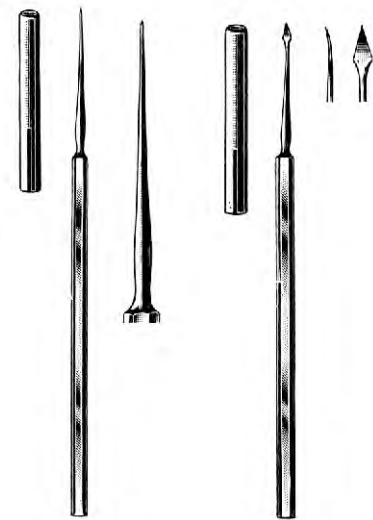


KEYS
 10.0cm

- 1 ○ Ai 26-7466-02 2mm
- 2 ○ Ai 26-7466-03 3mm
- 3 ○ Ai 26-7466-04 4mm
- 4 ○ Ai 26-7466-05 5mm
- 5 ○ Ai 26-7466-06 6mm
- 6 ○ Ai 26-7466-07 7mm
- 7 ○ Ai 26-7466-08 8mm



Ai 26-7467-00
 Biopsy set for taking skin specimen
 core drills 1.5, 3.0, 4.5mm ø



Ai 26-7468-13
 13.0cm

Ai 26-7469-13
 13.0cm



EN Tracheotomy

DE Tracheotomie

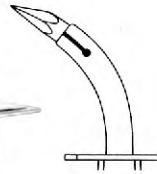
ES Traqueotomía

Page 641 to 650





UCKERMANN
13.0cm



Ai 27-7501-07 7.5mm Ø
 Ai 27-7501-09 9mm Ø



TROUSSEAU
 Ai 27-7502-12 12.0cm
 Ai 27-7502-14 14.0cm



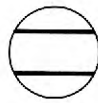
LABORDE
 Ai 27-7503-14
 14.0cm



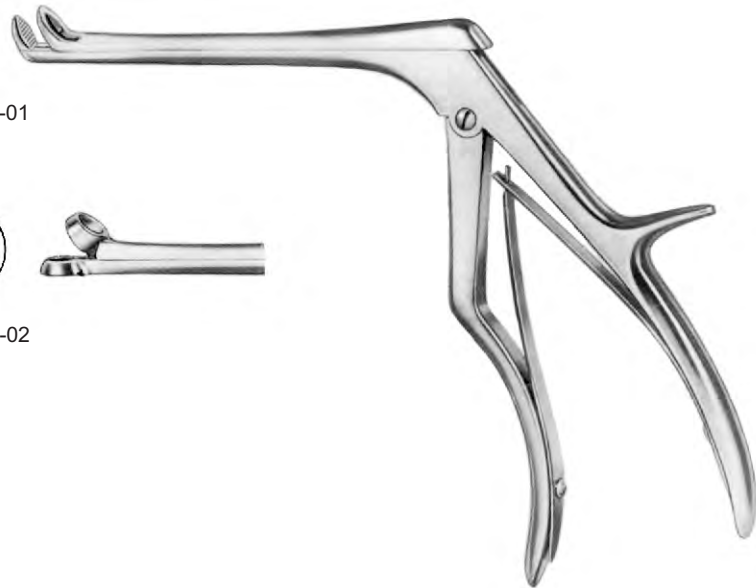
WEERDA
 Ai 27-7504-09
 19.0cm



Ai 27-7506-01



Ai 27-7506-02



BOSE
 Ai 27-7505-07
 7.0cm





LUKENS
 Ai 27-7507-17
 17.0cm



JACKSON
 Ai 27-7508-17
 17.0cm



JACKSON
 sharp blunt
 Ai 27-7509-18 18.0cm Ai 27-7510-18



Ai 27-7511-01 sharp
 Ai 27-7511-02 blunt
 18.0cm



Ai 27-7512-01 sharp
 Ai 27-7512-02 blunt
 18.0cm



SCHOENBORN
 Ai 27-7513-21
 21.0cm





ROSE
 Ai 27-7514-13
 13.0cm



LUER
 Ai 27-7515-11
 11.0cm



JACKSON
 Ai 27-7516-15
 15.0cm



Ai 27-7517-15
 15.0cm



ITERSON
 16.0cm



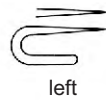
Ai 27-7518-01
 Sharp



Ai 27-7518-02
 Blunt



BOSE
 Ai 27-7519-16
 16.0cm



left



BOSE
 Ai 27-7520-16
 16.0cm



right

International scale

Fig.	0	1	2	3	4	5	6	7	8	9
Diameter	④	⑤	⑥	⑦	⑧	⑨	⑩	⑪	⑫	⑬mm
Length of outer tube N	45	50	55	60	65	70	75	80	85	90mm



LUER

Fig	mmØ	45-90mm	95mm	105mm
0	4	Ai 27-7521-04		
1	5	Ai 27-7521-05		
2	6	Ai 27-7521-06		
3	7	Ai 27-7521-07		
4	8	Ai 27-7521-08	Ai 27-7522-08	Ai 27-7523-08
5	9	Ai 27-7521-09	Ai 27-7522-09	Ai 27-7523-09
6	10	Ai 27-7521-10	Ai 27-7522-10	Ai 27-7523-10
7	11	Ai 27-7521-11	Ai 27-7522-11	Ai 27-7523-11
8	12	Ai 27-7521-12	Ai 27-7522-12	Ai 27-7523-12
9	13	Ai 27-7521-13	Ai 27-7522-13	Ai 27-7523-13



CHEVALIER-JACKSON

Fig	mmØ	45-90mm
0	4	Ai 27-7524-04
1	5	Ai 27-7524-05
2	6	Ai 27-7524-06
3	7	Ai 27-7524-07
4	8	Ai 27-7524-08
5	9	Ai 27-7524-09
6	10	Ai 27-7524-10
7	11	Ai 27-7524-11
8	12	Ai 27-7524-12
9	13	Ai 27-7524-13





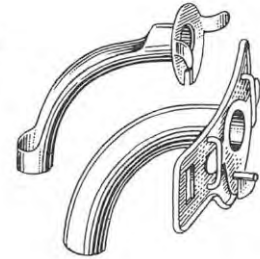
KRISHABER

Fig	mm	
0	4	Ai 27-7525-04
1	5	Ai 27-7525-05
2	6	Ai 27-7525-06
3	7	Ai 27-7525-07
4	8	Ai 27-7525-08
5	9	Ai 27-7525-09
6	10	Ai 27-7525-10
7	11	Ai 27-7525-11
8	12	Ai 27-7525-12



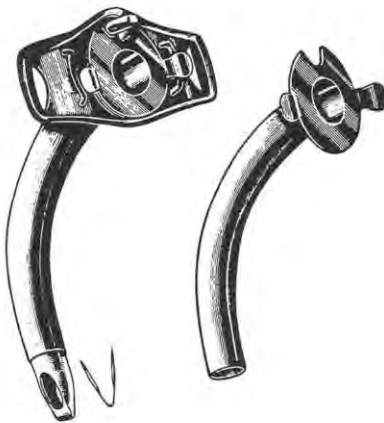
KRISHABER-LUER

Fig	mm	
0	4	Ai 27-7526-04
1	5	Ai 27-7526-05
2	6	Ai 27-7526-06
3	7	Ai 27-7526-07
4	8	Ai 27-7526-08
5	9	Ai 27-7526-09
6	10	Ai 27-7526-10
7	11	Ai 27-7526-11
8	12	Ai 27-7526-12



PARKER

Fig	F.G	
1	16	Ai 27-7527-16
2	18	Ai 27-7527-18
3	20	Ai 27-7527-20
4	22	Ai 27-7527-22
5	24	Ai 27-7527-24
6	26	Ai 27-7527-26
7	28	Ai 27-7527-28
8	30	Ai 27-7527-30
9	32	Ai 27-7527-32



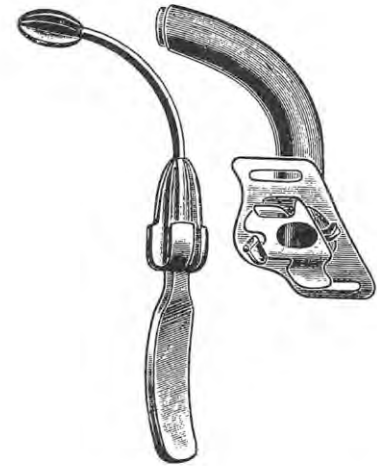
COLLIN

Fig	mm	
0	4	Ai 27-7528-04
1	5	Ai 27-7528-05
2	6	Ai 27-7528-06
3	7	Ai 27-7528-07
4	8	Ai 27-7528-08
5	9	Ai 27-7528-09
6	10	Ai 27-7528-10
7	11	Ai 27-7528-11
8	12	Ai 27-7528-12



FULLER

Fig	F.G	
1	18	Ai 27-7529-18
2	20	Ai 27-7529-20
3	22	Ai 27-7529-22
4	24	Ai 27-7529-24
5	26	Ai 27-7529-26
6	28	Ai 27-7529-28
7	30	Ai 27-7529-30
8	32	Ai 27-7529-32



CUBLEY

Fig	F.G	
1	16	Ai 27-7530-16
2	18	Ai 27-7530-18
3	20	Ai 27-7530-20
4	22	Ai 27-7530-22
5	24	Ai 27-7530-24
6	26	Ai 27-7530-26
7	28	Ai 27-7530-28
8	30	Ai 27-7530-30
9	32	Ai 27-7530-32

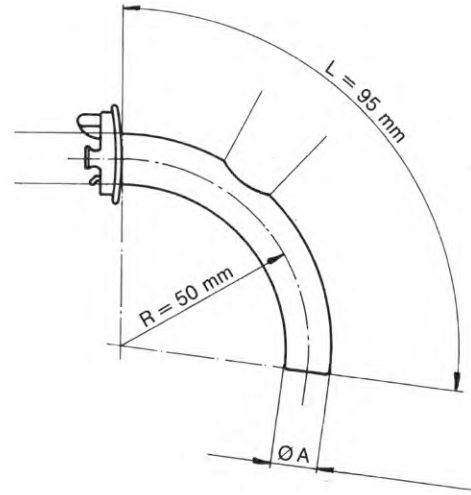
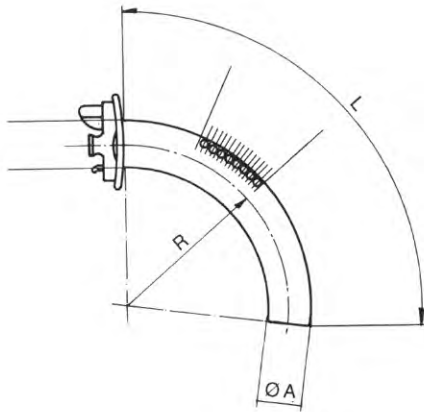


Fig		ØA	L	R
0	Ai 27-7531-08	8	65	36.5
1	Ai 27-7531-09	9	70	29
2	Ai 27-7531-10	10	75	40.5
3	Ai 27-7531-11	11	80	41.5
4	Ai 27-7531-12	12	85	43
5	Ai 27-7531-13	13	90	47.5

Fig		ØA	L	R
0	Ai 27-7532-08	8	95	50
1	Ai 27-7532-09	9	95	50
2	Ai 27-7532-10	10	95	50
3	Ai 27-7532-11	11	95	50
4	Ai 27-7532-12	12	95	50
5	Ai 27-7532-13	13	95	50



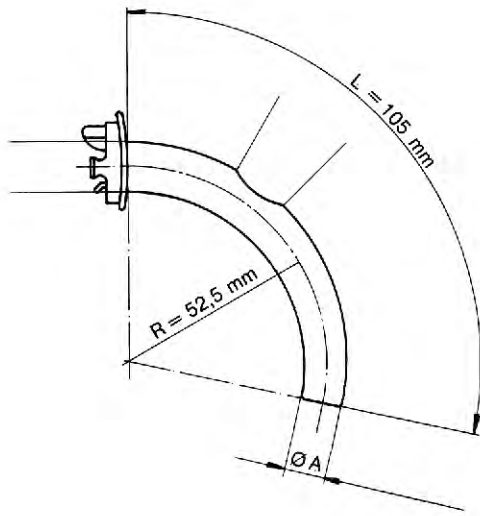


Fig		ØA	L	R
0	Ai 27-7533-08	8	105	52.5
1	Ai 27-7533-09	9	105	52.5
2	Ai 27-7533-10	10	105	52.5
3	Ai 27-7533-11	11	105	52.5
4	Ai 27-7533-12	12	105	52.5
5	Ai 27-7533-13	13	105	52.5

12mm Ø

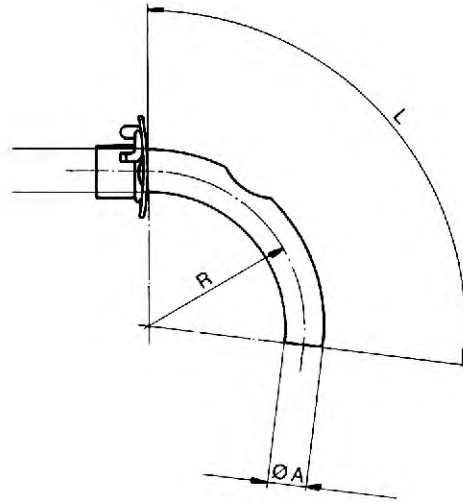


Ai 27-7534-26
26.0cm



WAGENER-MOSHER
20.0cm

- Ai 27-7535-05 5mm Ø
- Ai 27-7535-07 7mm Ø
- Ai 27-7535-09 9mm Ø

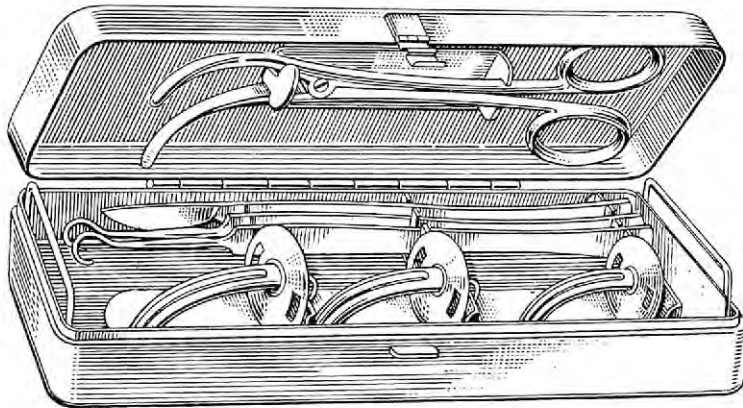


KOENIG

Fig	mmØ	50-80mm
1	5	Ai 27-7536-05
2	6	Ai 27-7536-06
3	7	Ai 27-7536-07
4	8	Ai 27-7536-08
5	9	Ai 27-7536-09
6	10	Ai 27-7536-10
7	11	Ai 27-7536-11

Fig		ØA	L	R
0	Ai 27-7537-08	8	65	36.5
1	Ai 27-7537-09	9	70	39
2	Ai 27-7537-10	10	75	40.5
3	Ai 27-7537-11	11	80	41.5
4	Ai 27-7537-12	12	85	43
5	Ai 27-7537-13	13	90	47.5





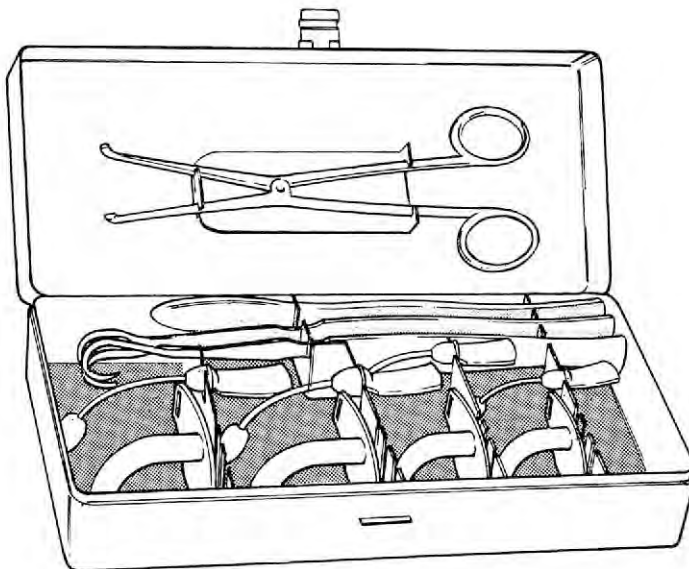
Ai 27-7538-00

TRACHEOTOMY SET

Ai 27-7538-00

complete in stainless steel case comprising:

- Fuller tracheotomy tube, 18
- Fuller tracheotomy tube, 22
- Fuller tracheotomy tube, 26
- Tracheal hook, sharp
- Tracheal hook, blunt
- Scalpel, stainless, 3cm
- Trousseau, tracheal, dilating forcep



Ai 27-7539-00

TRACHEOTOMY SET

Ai 27-7539-00

complete in stainless steel case comprising:

- Parker tracheotomy tube, 18
- Parker tracheotomy tube, 22
- Parker tracheotomy tube, 24
- Parker tracheotomy tube, 26
- Tracheal hook, sharp.
- Tracheal hook, double blunt.
- Scalpel, stainless, 3cm
- Trousseau, tracheal, dilating forcep



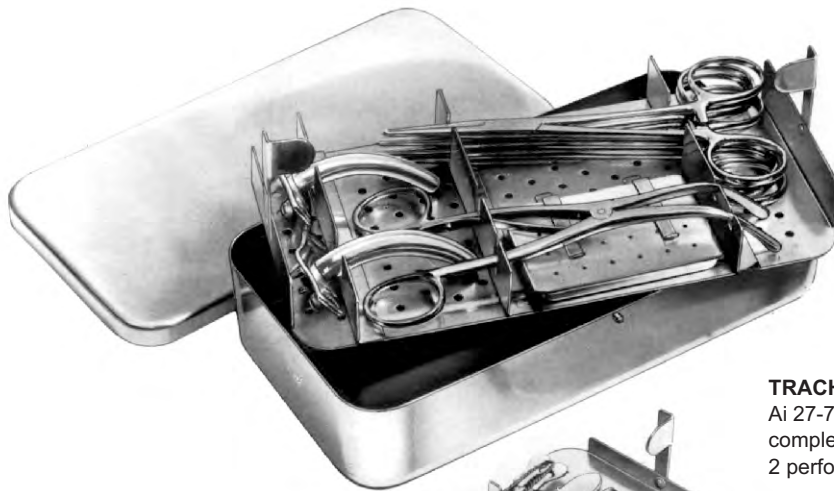
Ai 27-7540-00
 200 x 105 x 30mm

TRACHEOTOMY SET

Ai 27-7540-00

complete in metal case, consisting of:

- 1 Handle with 1 blade, Fig. 20
- 1 Handle with 1 blade, Fig. 23
- 1 Thumb forceps, 13.0cm
- 1 Tissue forcep, 13.0cm 1 x 2 teeth
- 2 Pean Artery Forceps, 13.0cm
- 1 Grooved Director, 14.0cm
- 1 Trachea Dilator
- 2 Iterson Trachea Retractors, blunt
- 1 Bose Trachea Retreector, sharp left hand side
- 1 ditto, right hand side
- 1 Luer Trachea Tube, Standard
- 1 ditto
- 1 Cleaning Brush



Ai 27-7541-00
 200 x 100 x 40mm

TRACHEOTOMY SET

Ai 27-7541-00

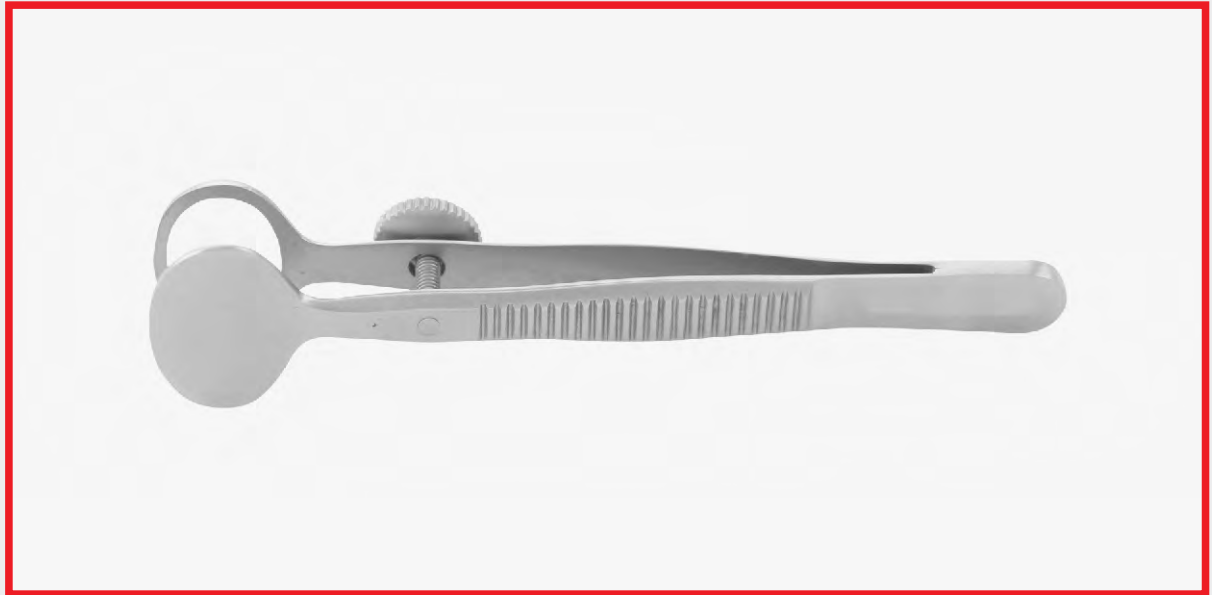
complete in metal case 200 x 100 x 40 mm, with 2 perforated trays of 18/8 s/s containing the following instruments:

- 1 Scalpel Handle No. 4, with blade No. 20
- 1 Scalpel Handle No. 4, with blade No. 23
- 3 Scalpel Blades, assorted, in perforated small case.
- 1 Small case for above Scalpel Blades
- 1 Dressing Forceps, serrated, 13.0cm
- 2 Tissue Forceps, 1 x 2 teeth, 13.0cm
- 4 Crile Artery Forceps, straight, 14.0cm
- 1 Grooved Director, 14.0cm
- 1 Trousseau Trachea Dilator, 14.0cm
- 2 Iterson Trachea Hooks, blunt
- 1 Bose Hook, sharp, left hand side, 16.0cm
- 1 ditto, right hand side, 16.0cm
- 1 Luer Trachea Tube, size 2.6mm diam. German Silver.
- 1 ditto, size 4.8mm diam, German Silver.
- 1 Cleaning Brush, 12mm diam. 26.0cm



- EN** Ophthalmology
- DE** Ophthalmologie
- ES** Oftalmología

Page 651 to 681





Children **Weiss** Adults
 Ai 28-7601-07 Ai 28-7602-09
 7 cm/2¾" 9 cm/3½"



Children **Weiss** Adults
 Ai 28-7603-07 Ai 28-7604-09
 7 cm/2¾" 9 cm/3½"



Park
 Ai 28-7605-08
 8 cm/3¼"



Park-Guyton
 Ai 28-7606-08
 8 cm/3¼"



Park-Maumenee
 Ai 28-7607-08
 8 cm/3¼"



Barraquer (Colibri)
 Children Adults
 Ai 28-7608-03 Ai 28-7609-04
 3 cm/1¼" 4 cm/1½"



Sauer
 Ai 28-7612-03
 3 cm/1¼"



Barraquer
 Ai 28-7610-04
 4 cm/1½"



Bowman
 Ai 28-7611-07
 7 cm/2¾"

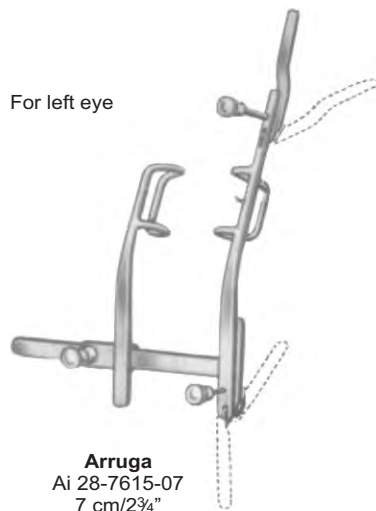


Goldstein
 Ai 28-7613-03
 3 cm/1¼"



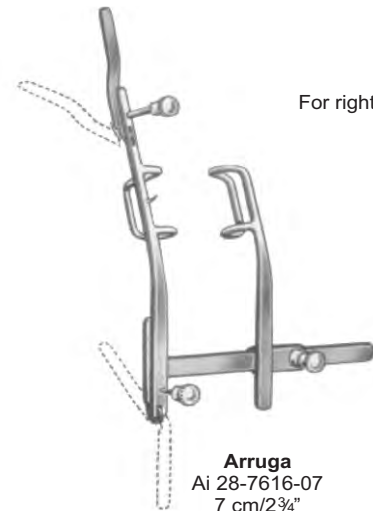
Pley
 Ai 28-7614-06
 6 cm/2¼"

For left eye



Arruga
 Ai 28-7615-07
 7 cm/2¾"

For right eye



Arruga
 Ai 28-7616-07
 7 cm/2¾"



Mellinger-Axenfeld
 Ai 28-7617-07
 7 cm/2 3/4"



Mellinger-Axenfeld
 Ai 28-7618-07
 7 cm/2 3/4"



Children **Mellinger** Adults
 Ai 28-7619-05 Ai 28-7620-07
 5 cm/2 3/4" 7 cm/2 3/4"



Children **Mellinger Beard** Adults
 Ai 28-7621-05 Ai 28-7622-07
 5 cm/2" 7 cm/2 3/4"



Knapp Clark
 Ai 28-7623-08
 8 cm/3 1/4"



Children **Graefe** Adults
 Ai 28-7624-06 Ai 28-7625-09
 6 cm/2 1/2" 9 cm/3 1/2"



Lancaster
 Ai 28-7626-08
 8 cm/3 1/4"



Children **Williams** Adults
 Ai 28-7627-07 Ai 28-7628-08
 7 cm/2 3/4" 8 cm/3 1/4"



Lister-Burch
 Ai 28-7629-08
 8 cm/3 1/4"



Weiss
 Ai 28-7630-08
 8 cm/3 1/4"



Murdock
 Ai 28-7631-05
 5 cm/2"



Mueller
 Ai 28-7632-07
 7 cm/2 3/4"



Critchett
 Ai 28-7633-06
 6 cm/2 1/2"



Castroviejo
 Ai 28-7634-08
 8 cm/3 1/4"





Schepens
 Ai 28-7635-13
 13 cm/5"



Desmarres
 Ai 28-7636-13
 13 cm/5"



Conway
 Ai 28-7637-13
 13 cm/5"
 8 mm



Desmarres
 13 cm/5"

Ai 28-7638-12
 12 mm

Ai 28-7638-14
 14 mm

Ai 28-7638-16
 16 mm

Ai 28-7638-18
 18 mm

Lid plate



Jaeger
 Ai 28-7639-11
 11 cm/4 1/2"



Ai 28-7640-01

Ai 28-7640-02

Ai 28-7640-03

Ai 28-7640-04

Ai 28-7640-05

Ai 28-7640-06

Ai 28-7641-01

Ai 28-7641-02

Ai 28-7641-03

Ai 28-7641-04

Ai 28-7641-05

Ai 28-7641-06

Ai 28-7642-00

Ai 28-7642-01

Graefe

Ai 28-7642-02

Ai 28-7642-03

Ai 28-7642-04

Ai 28-7642-05

Ai 28-7643-01

Graefe-Arruga

Ai 28-7643-02

Ai 28-7643-03

Ai 28-7643-04

Deutschmann

Ai 28-7643-13

Wheeler

Ai 28-7643-12



Jaeger
 Ai 28-7644-01



Ai 28-7644-02



Ai 28-7644-03



Ai 28-7644-04



Ai 28-7645-01



Ai 28-7645-02



Ai 28-7645-03



Ai 28-7645-04



Ai 28-7646-01



Ai 28-7646-02



Ai 28-7646-03



Ai 28-7646-04



Ai 28-7647-01



Ai 28-7647-02



Ai 28-7647-03



Ai 28-7647-04

Jaeger-Grieshaber



Ai 28-7648-01



Ai 28-7648-02



Ai 28-7648-03



Ai 28-7648-04

Jaeger-Grieshaber



Wessely-Grieshaber

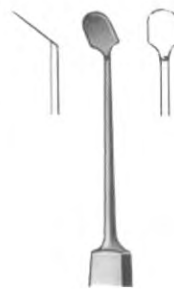
- Ai 28-7649-01 4 mm
- Ai 28-7649-02 5 mm
- Ai 28-7649-03 6 mm
- Ai 28-7649-04 7 mm



Wiener
 Ai 28-7650-13



Berens
 Ai 28-7651-13



Papst
 Ai 28-7652-13



Castroviejo
 Ai 28-7653-13



Castroviejo
 Ai 28-7654-09
 9 cm/3½"



Castroviejo
 Ai 28-7655-09
 9 cm/3½"



Castroviejo
 Ai 28-7656-09
 9 cm/3½"





Mod. Hamburg
Ai 28-7657-12



Graefe
Ai 28-7658-13



Weber
Ai 28-7659-01



Weber
Ai 28-7659-02



Weber
Ai 28-7659-03



Bowman
Ai 28-7660-04
0.4 mm



Bowman
Ai 28-7660-05
0.5 mm



Bowman
Ai 28-7660-06
0.6 mm



Bowman
Ai 28-7660-07
0.7 mm



Bowman
Ai 28-7660-08
0.8 mm



Left **Bowman** Right
Ai 28-7661-01 Ai 28-7661-02



Knapp
Ai 28-7662-01



Knapp
Ai 28-7662-02



Knapp
Ai 28-7662-03



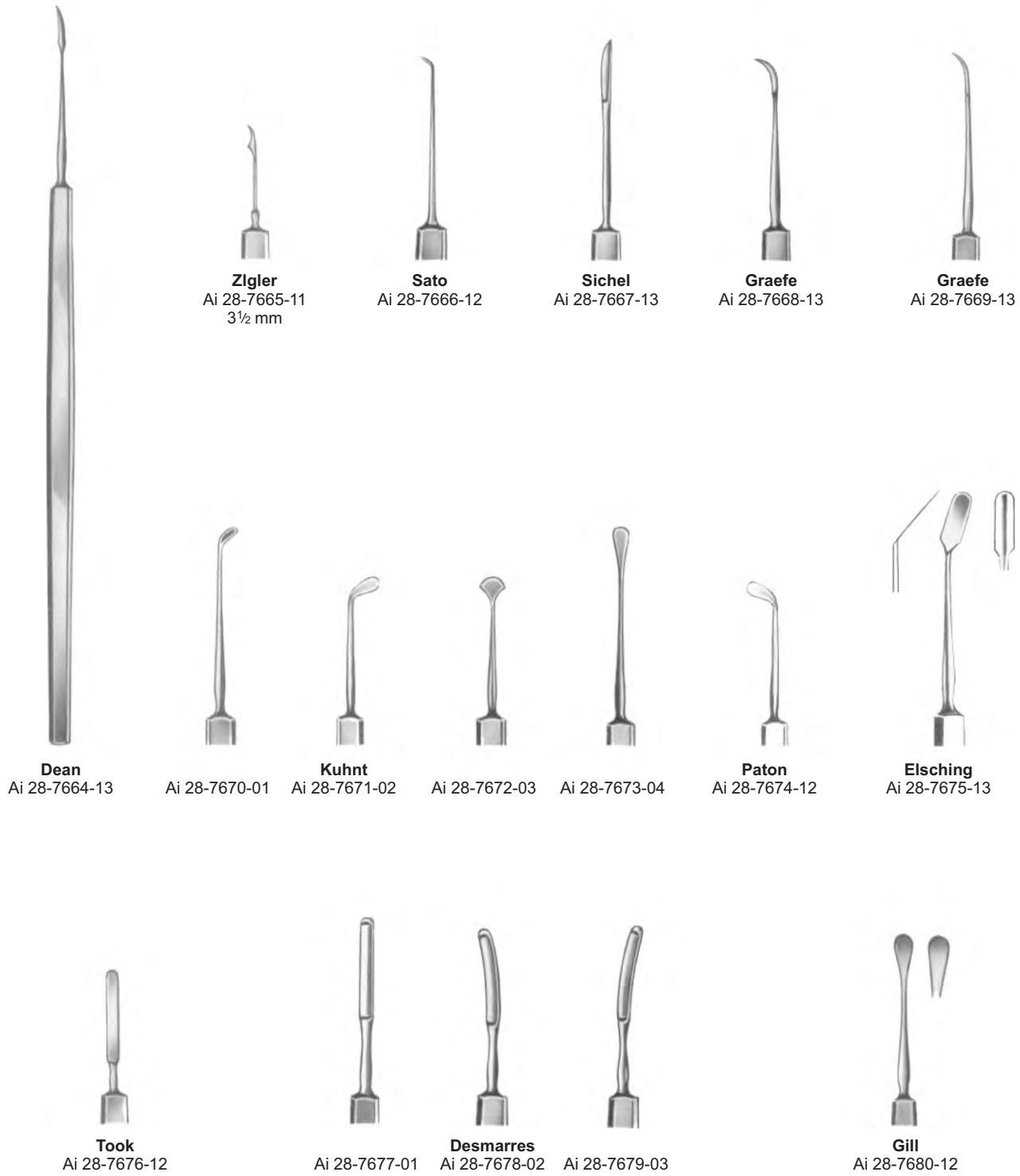
Ziegler
Ai 28-7663-05
5 mm



Ziegler
Ai 28-7663-06
6 mm



Ziegler
Ai 28-7663-07
7 mm





Guthrie
Ai 28-7681-12



Guthrie
Ai 28-7682-13



Berens
Ai 28-7683-12



Knapp Blunt
Ai 28-7684-13



Rollet Sharp
Ai 28-7685-12



Rollet
Ai 28-7686-12



Fink Blunt
Ai 28-7687-12



Right
Ai 28-7688-01

Left
Ai 28-7688-02

10.5 cm/4 1/4"



Flexible
Ai 28-7689-03 Ai 28-7689-04



Knapp-Rollet
Ai 28-7689-02



Axenfeld

Sharp
 Ai 28-7690-14
 Blunt
 Ai 28-7691-14



Axenfeld

Sharp
 Ai 28-7692-14
 Blunt
 Ai 28-7693-14



Paul
 Ai 28-7694-12



Sautter
 Ai 28-7695-01



Sautter
 Ai 28-7696-02



Sautter
 Ai 28-7697-03



Arruga
 Ai 28-7698-13



Stevens
 Ai 28-7699-14



Stevens
 Ai 28-7700-12



Graefe
 Ai 28-7701-01



Graefe
 Ai 28-7702-02



Graefe
 Ai 28-7703-03



Wecker
 Ai 28-7704-13



Wecker
 Ai 28-7705-13



Stock
 Ai 28-7706-13



Stock
 Ai 28-7707-13



Culler
 Ai 28-7708-13



Suker
 Ai 28-7709-14





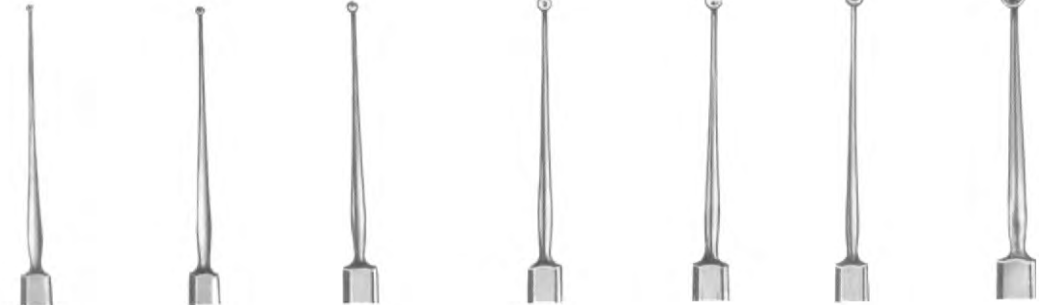
Enucleation Scoops

Small
Ai 28-7710-16

Large
Ai 28-7710-20

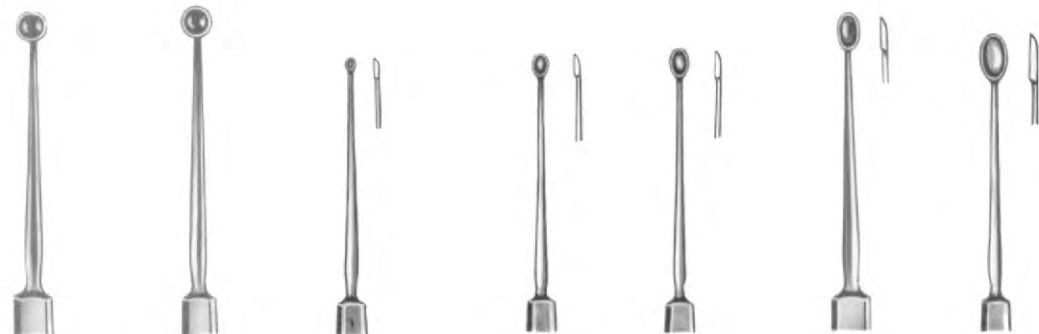
Wells

Chalazion Curettes



Meyhoefer

Ai 28-7711-05 0.5 mm Ø Ai 28-7711-10 1.0 mm Ø Ai 28-7711-15 1.5 mm Ø Ai 28-7711-18 1.8 mm Ø Ai 28-7711-20 2.0 mm Ø Ai 28-7711-25 2.5 mm Ø Ai 28-7711-35 3.5 mm Ø



Hebra

Meyhoefer Ai 28-7711-40 4.0 mm Ø Meyhoefer Ai 28-7711-45 4.5 mm Ø Hebra Ai 28-7712-10 1.0 mm Ø Hebra Ai 28-7712-20 2.0 mm Ø Hebra Ai 28-7712-25 2.5 mm Ø Hebra Ai 28-7712-30 3.0 mm Ø Hebra Ai 28-7712-35 3.5 mm Ø

Exenteration Scoops



Ai 28-7713-01



Ai 28-7713-02



Bunge
Ai 28-7713-03



Ai 28-7713-04



Ai 28-7713-05



Chalazion Curette, Double

Axenfeld
Ai 28-7714-13
13 cm/5"



Lachrymal Sac Dissector

Lang
Ai 28-7715-13
13 cm/5"



Irrigating Cannulas

Straight



Binkhorst
 Ai 28-7716-01
 22 gauge

Right



Binkhorst
 Ai 28-7717-02
 22 gauge

Left



Binkhorst
 Ai 28-7718-03
 22 gauge

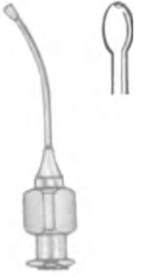


Bonn
 Ai 28-7719-04
 20 gauge



Bonn
 Ai 28-7720-05
 19 gauge

Probe Point

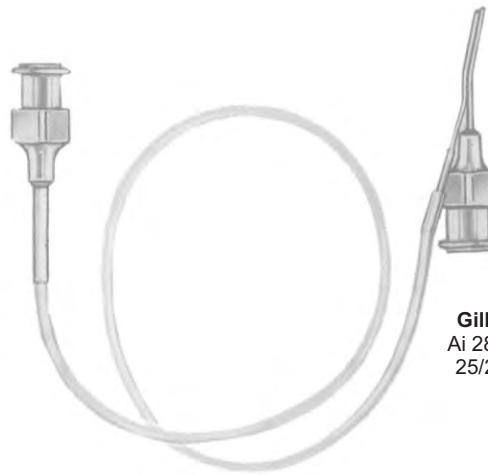


Hamburg
 Ai 28-7721-06
 23 gauge

Irrigation/Aspiration Cannulas



Simcoe
 Ai 28-7722-01
 23 gauge



stotome Cannulas
Gills-Welsh
 Ai 28-7723-02
 25/23 gauge

Lens Mainpulation Cannulas



Knolle-Kelmann
 Ai 28-7724-01
 22 gauge



Nevyas
 Ai 28-7725-02
 22 gauge



Kratz
 Ai 28-7726-03
 22 gauge



Freeman
 Ai 28-7727-01
 27 gauge



Irrigating Vectis Cannulas



Cortex Aspiration Cannulas



Capsule Polishing Cannulas





Castroviejo
Ai 28-7736-15



Castroviejo
Ai 28-7737-20
20 mm



Holth
Ai 28-7738-01



Haitz
Ai 28-7739-02



West
Ai 28-7740-16
16 cm/6 1/4"



West
Ai 28-7741-16
16 cm/6 1/4"



Connin-Amsler
Ai 28-7742-13
13 cm/5"



Wilder
Ai 28-7743-01



Wilder
Ai 28-7744-02



Wilder
Ai 28-7745-03



Ai 28-7746-13 Ai 28-7747-13

Neddle Only
 Ai 28-7748-01

Chisel Only
 Ai 28-7748-02

Gouge Only
 Ai 28-7748-03



Ai 28-7749-13

Instrumentation for D. B. Kirby Operations



Ai 28-7750-10



Teeth
 Ai 28-7751-10 1:2 Teeth
 Ai 28-7752-10 2:3 Teeth



Ai 28-7753-10
 1 : 2



Kirby
 Ai 28-7754-10
 10 cm/4"



Kirby
 Ai 28-7755-10
 10 cm/4"



Ai 28-7756-10



Ai 28-7757-10





Tuebingen
 Ai 28-7758-10
 10 cm/4"



Ai 28-7759-08
 8.5 cm/3 1/2"



Paufique
 Ai 28-7760-10
 10 cm/4"



Barraquer
 Ai 28-7761-10
 10.5 cm/4 1/4"



McPherson
 Ai 28-7762-10
 10 cm/4"



McPherson
 Ai 28-7763-07
 7.5 cm/3"



McCullough
 Ai 28-7764-09
 9.5 cm/3 3/4"



McCullough
 Ai 28-7765-09
 9.5 cm/3 3/4"



Bonaccito
 Ai 28-7766-10
 10 cm/4"



Bonaccito
 Ai 28-7767-10
 10 cm/4"



Ai 28-7768-11
 11 cm/4 1/2"



11 cm/4 1/2"



Ai 28-7769-11
 1 : 2



Ai 28-7770-11
 2 : 3



Nugent
 10 cm/4"

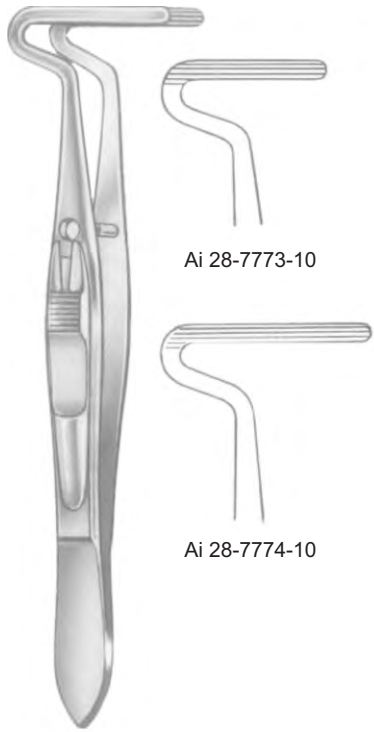


Ai 28-7771-01



Ai 28-7772-02





Berke
10 cm/4"



Blascovics
Ai 28-7775-09
9 cm/3 1/2"



Blascovics
Ai 28-7776-09
9 cm/3 1/2"



Worth
Ai 28-7777-10
10 cm/4"



Worth
Ai 28-7778-10
10 cm/4"



Jameson
Ai 28-7779-10
10 cm/4"



Jameson
Ai 28-7780-10
10 cm/4"



Prince
Ai 28-7781-10
10 cm/4"



Prince
Ai 28-7782-10
10 cm/4"



Snellen
 Ai 28-7783-10
 10 cm/4"



Snellen
 Ai 28-7784-10
 10 cm/4"



Erhardt
 Ai 28-7785-09
 9 cm/3 1/2"



Barraquer
 Ai 28-7786-05
 5.5 cm/2 1/4"

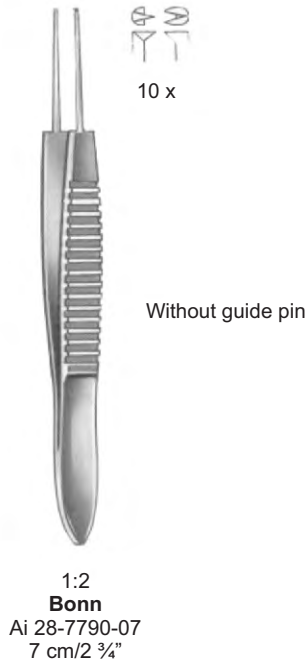


Barraquer
 Ai 28-7787-05
 5.5 cm/2 1/4"



Barraquer
 Ai 28-7788-05
 5.5 cm/2 1/4"







Graefe
10 cm/4"



Ai 28-7796-10



Ai 28-7797-10



Ai 28-7798-10



Ai 28-7799-10



Ai 28-7800-10



Ai 28-7801-10

Conjunctival forceps



Stevens
10.5 cm/4¼"



Ai 28-7802-10



Ai 28-7803-10



Ai 28-7804-10



Ai 28-7805-10



Ai 28-7806-10



Ai 28-7807-10



O'Connor
Ai 28-7808-10
10 cm/4"



Stevens
Ai 28-7809-11
11 cm/4½"



Stevens
Ai 28-7810-11
11 cm/4½"





Fischer
 Ai 28-7811-07
 7 cm/2 3/4"



Fischer-Arit
 Ai 28-7812-07
 7 cm/2 3/4"



Hess
 Ai 28-7813-07
 7 cm/2 3/4"



Hess
 Ai 28-7814-07
 7 cm/2 3/4"



Smooth **Chandler** Serrated
 Ai 28-7815-01 7 cm/2 3/4" Ai 28-7816-02



Fuchs
 Ai 28-7817-07
 7 cm/2 3/4"



Gill-Hess
 Ai 28-7818-07
 7.5 cm/3"



Gill-Hess Teeth Below
 Ai 28-7819-07
 7.5 cm/3"
 Teeth on side
 Ai 28-7820-07



Barraquer-Katzin
 (Colibri)
 Ai 28-7821-07
 7 cm/2 3/4"



Fuchs
 Ai 28-7822-07
 7 cm/2 ¾"



Kalt
 Ai 28-7823-10
 10 cm/4"



Terson
 Ai 28-7824-09
 9.5 cm/3 ¾"



Arruga-Nizetic
 Ai 28-7825-10
 10 cm/4"



Castroviejo
 Ai 28-7826-10
 10 cm/4"



Castroviejo
 Ai 28-7827-10
 10 cm/4"



Elschnig
 Ai 28-7828-10
 10 cm/4"

For Len Implantation



Binkhorst
 Ai 28-7829-07
 7 cm/2 ¾"



Arruga
 Ai 28-7830-09
 9.5 cm/3 ¾"



Arruga
 Ai 28-7831-09
 9.5 cm/3 ¾"





Knapp
 Ai 28-7832-11
 11 cm/4¼"



Ayer
 Ai 28-7833-09
 9 cm/3½"



Ayer
 Ai 28-7834-09
 9 cm/3½"



Lambert
 Ai 28-7835-09
 9 cm/3½"



Desmarres
 9 cm/3½"



Ai 28-7836-01



Ai 28-7837-02



Ai 28-7838-03



Fig. 1



Fig. 2



Fig. 3



Noyes
 Ai 28-7840-12
 12 cm/4 3/4"



Wecker
 11.5 cm/4 1/2"



Ai 28-7841-01

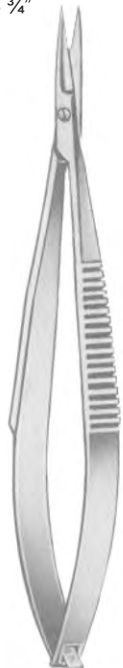


Ai 28-7842-02



Barraquer
 Ai 28-7843-05
 5.5 cm/2 1/4"

Noyes
 Fig.1 Ai 28-7839-01
 Fig.2 Ai 28-7839-02
 Fig.3 Ai 28-7839-03
 12 cm/4 3/4"



Ai 28-7844-09
 9 cm/3 1/2"



Ai 28-7845-09



Ai 28-7846-09



Ai 28-7847-09

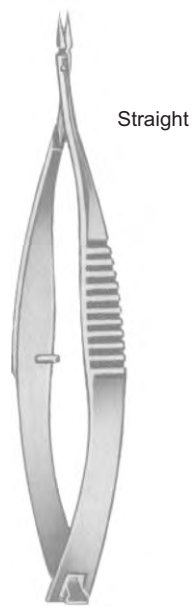


Ai 28-7848-09



Ai 28-7849-09





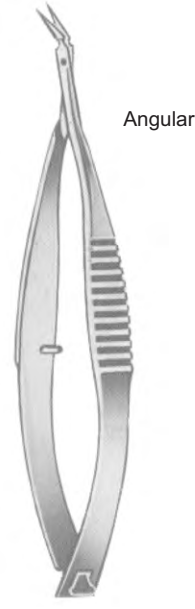
Straight

Vannas
 Ai 28-7850-08
 8 cm/3 1/4"



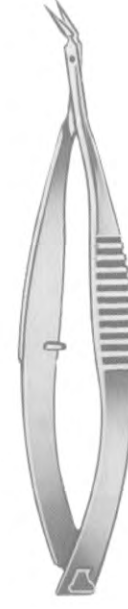
Curved

Vannas
 Ai 28-7851-08
 8 cm/3 1/4"



Angular

Vannas
 Ai 28-7852-08
 8 cm/3 1/4"



Vannas
 Ai 28-7853-08
 8 cm/3 1/4"



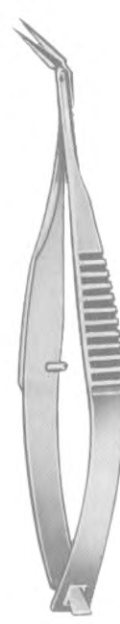
Straight

Ai 28-7854-08
 8.5 cm/3 1/4"



Curved

Ai 28-7855-08
 8.5 cm/3 1/4"



Angular

Ai 28-7856-08
 8.5 cm/3 1/4"



Angular

Ai 28-7857-08
 8.5 cm/3 1/4"



Ai 28-7858-10
10 cm/4"



Ai 28-7859-10
10 cm/4"



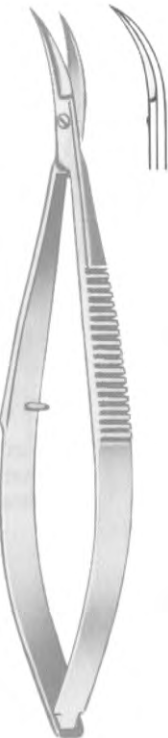
Castroviejo
Ai 28-7860-10
10 cm/4"



Castroviejo
Ai 28-7861-10
10 cm/4"



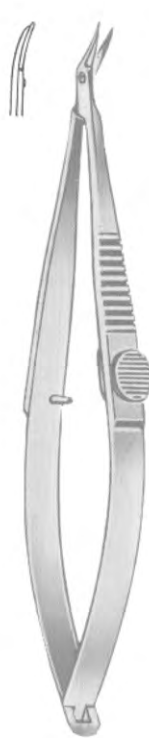
Aebli
Ai 28-7862-10
10 cm/4"



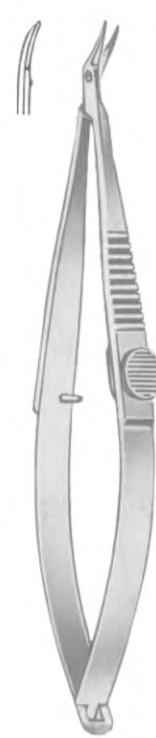
Castroviejo
Ai 28-7863-10
10 cm/4"



Castroviejo
Ai 28-7864-10
10 cm/4"

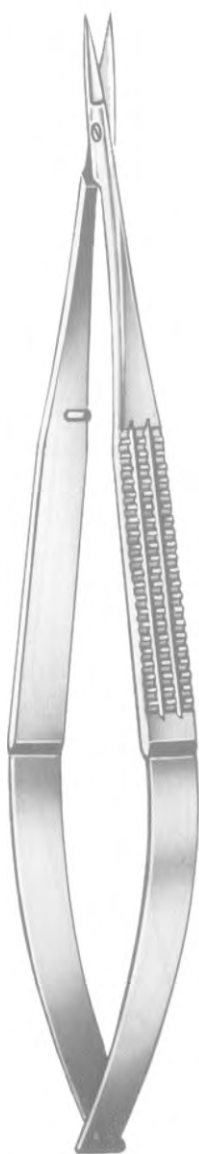


Troutman-Barraquer
Ai 28-7865-10
10 cm/4"

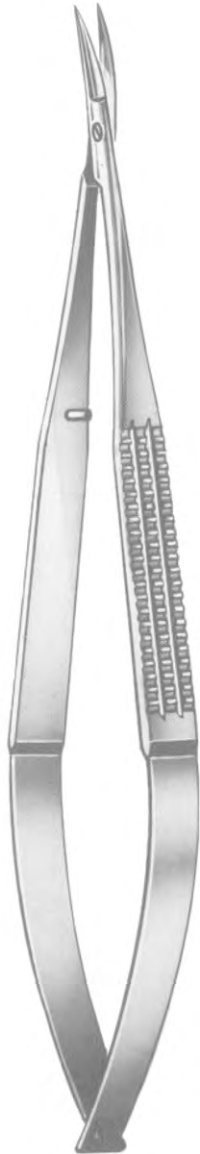


Troutman-Barraquer
Ai 28-7866-10
10 cm/4"

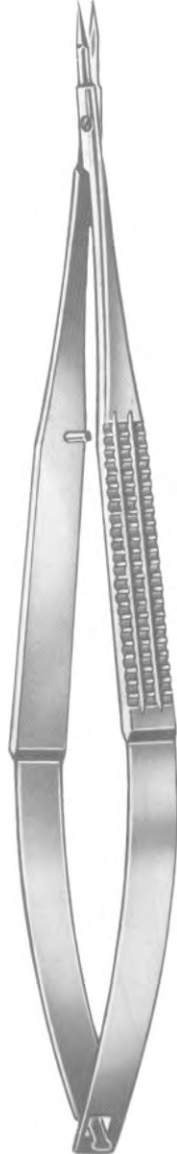




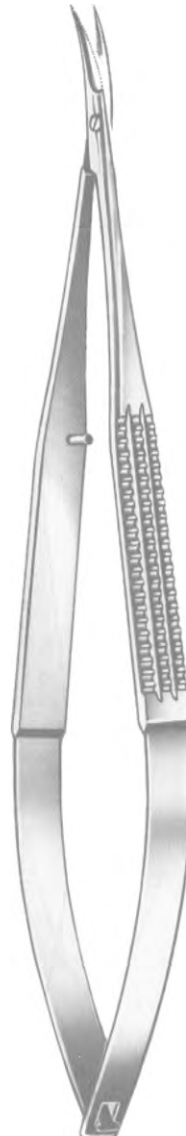
Straight
 Ai 28-7867-16
 16cm/6 1/4"



Curved
 Ai 28-7868-16
 16cm/6 1/4"



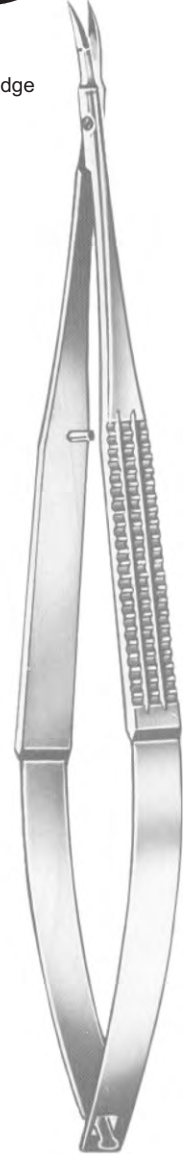
Straight
 Ai 28-7869-16
 16cm/6 1/4"



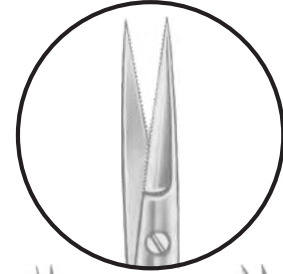
Curved
 Ai 28-7870-16
 16cm/6 1/4"



Millesi
Straight
 Ai 28-7871-16
 16cm/6 1/4"



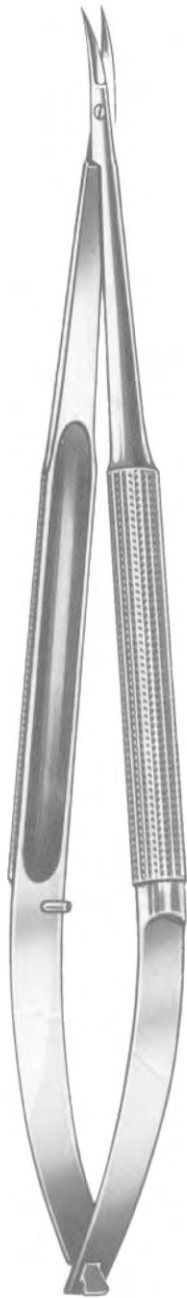
Millesi
Curved
 Ai 28-7872-16
 16cm/6 1/4"



Saw Edge



Straight
Ai 28-7873-18
18.5cm/7 1/4"



Curved
Ai 28-7874-18
18.5cm/7 1/4"



Angular
Ai 28-7875-18
18.5cm/7 1/4"



Straight
Ai 28-7876-23
23cm/9"





Straight
Ai 28-7877-14
14.5cm/5 3/4"



Curved
Ai 28-7878-14
14.5cm/5 3/4"

Dissecting Scissors



Curved
Ai 28-7879-14
14.5cm/5 3/4"

EN Gynecology

DE Gynäkologie

ES Ginecología

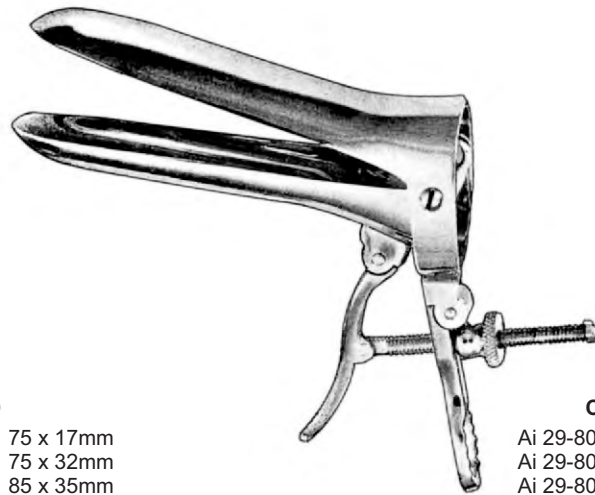
Page 682 to 722





CUSCO

- Ai 29-8001-01 75 x 17mm
- Ai 29-8001-02 75 x 32mm
- Ai 29-8001-03 85 x 35mm
- Ai 29-8001-04 100 x 37mm



CUSCO

- Ai 29-8002-01 75 x 17mm
- Ai 29-8002-02 75 x 32mm
- Ai 29-8002-03 80 x 32mm
- Ai 29-8002-04 85 x 35mm
- Ai 29-8002-05 110 x 35mm
- Ai 29-8002-06 115 x 37mm



CUSCO

- Ai 29-8003-01 75 x 32mm
- Ai 29-8003-02 85 x 35mm
- Ai 29-8003-03 100 x 35mm
- Ai 29-8003-04 85 x 35mm (with cold light carrier)
- Ai 29-8003-05 (cold light carrier only)



CUSCO

- Ai 29-8004-01 75 x 17mm
- Ai 29-8004-02 85 x 17mm
- Ai 29-8004-03 100 x 17mm



CUSCO (Swiss pattern)

- Ai 29-8005-01 80 x 22mm
- Ai 29-8005-02 100 x 25mm
- Ai 29-8005-03 105 x 27mm
- Ai 29-8005-04 115 x 27mm



CUSCO'S

- Ai 29-8006-01 (LL)
- Ai 29-8006-02 (L)
- Ai 29-8006-03 (M)
- Ai 29-8006-04 (S)
- Ai 29-8006-05 (SS)
- Ai 29-8006-06 (SSS)

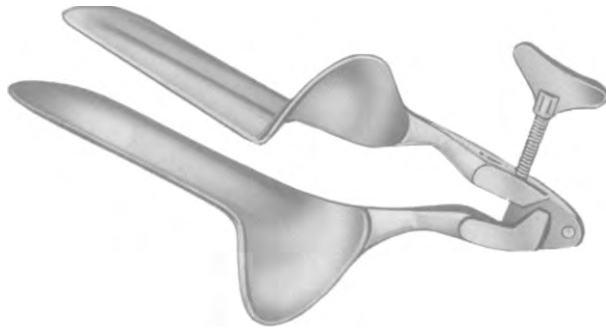


for children

COLLIN
Ai 29-8007-01 55 x 10mm



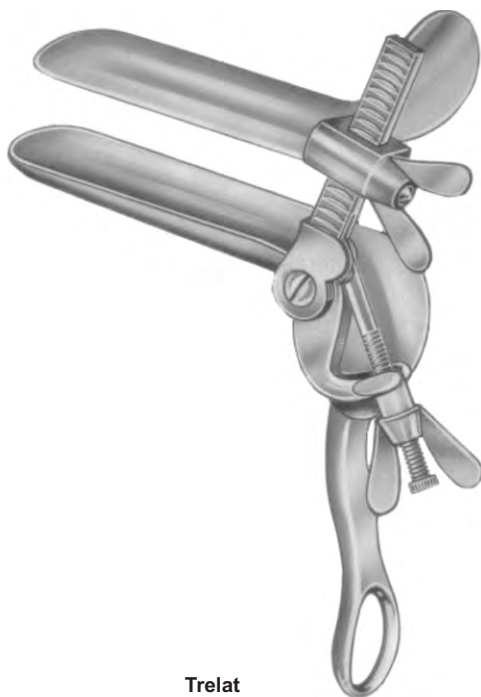
COLLIN
Ai 29-8007-02 65 x 20mm



Collin-Landau
Medium Ai 29-8007-03 35 x 100 mm

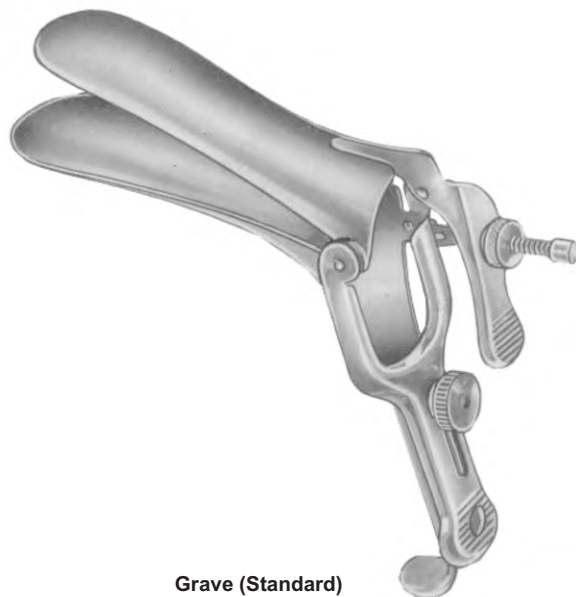


Collin
Small Ai 29-8007-12 30 x 85 mm
Medium Ai 29-8007-13 35 x 100 mm
Large Ai 29-8007-14 40 x 110 mm



Trelat

	a	b
	mm	mm
Ai 29-8008-01	85	33
Ai 29-8008-02	95	35
Ai 29-8008-03	115	43



Grave (Standard)

	a	b
	mm	mm
Ai 29-8009-01	75	20
Ai 29-8009-02	95	35
Ai 29-8009-03	115	35
Ai 29-8009-04	125	35





Black

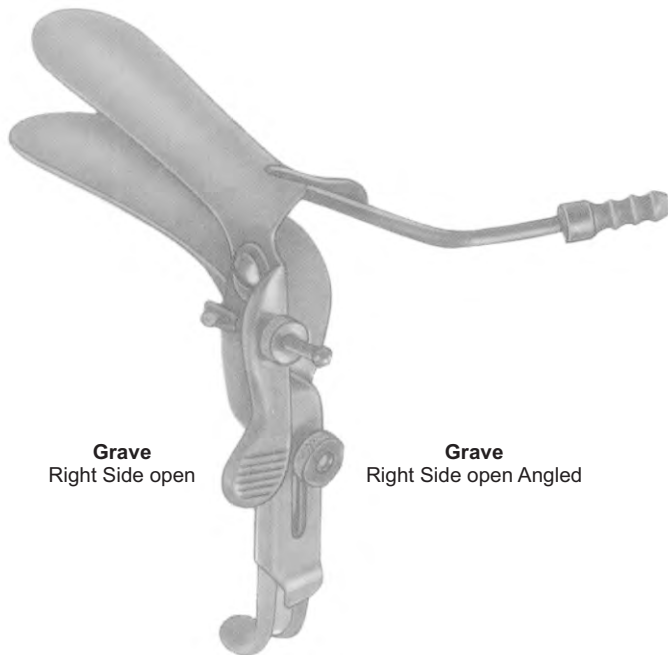
Grave	a mm	b mm
Ai 29-8010-01	75	20
Ai 29-8010-02	95	35
Ai 29-8010-03	115	35
Ai 29-8010-04	130	25



Grave	a mm	b mm
Angled 135°		
Ai 29-8011-00	101	35



Fergusson	
Ai 29-8011-01	25mm Ø
Ai 29-8011-02	30mm Ø
Ai 29-8011-03	35mm Ø
Ai 29-8011-04	40mm Ø

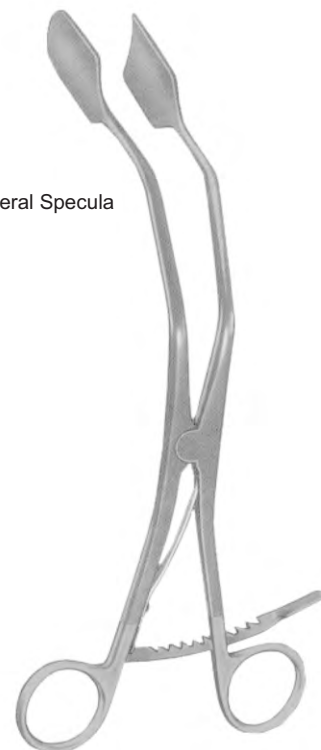


Grave
Right Side open

Grave
Right Side open Angled

	a mm	b mm
Ai 29-8012-01	101	
Ai 29-8012-02		35

Lateral Specula

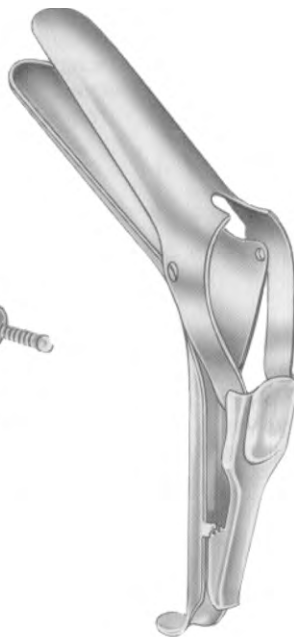


Ai 29-8013-00



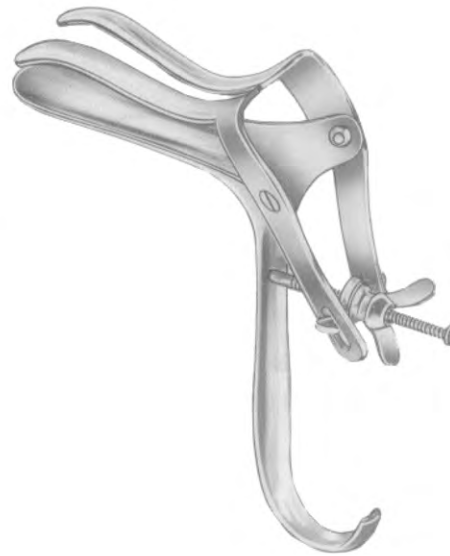
Pederson

	a	b
	mm	mm
Ai 29-8014-01	75	13
Ai 29-8014-02	100	22
Ai 29-8014-03	120	25
Ai 29-8014-04	130	25



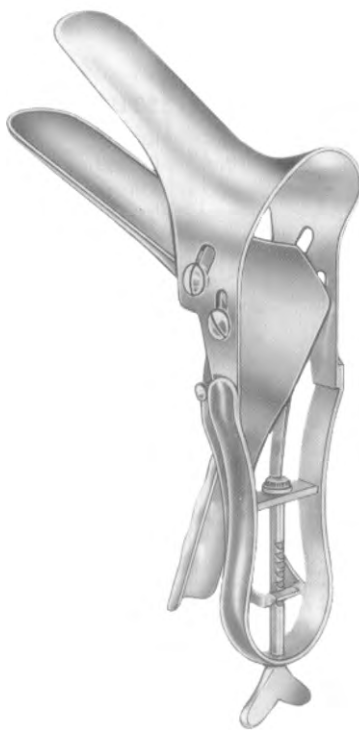
Semm

	a	b
	mm	mm
Ai 29-8015-01	90	14/18
Ai 29-8015-02	100	17/20
Ai 29-8015-03	100	25/30



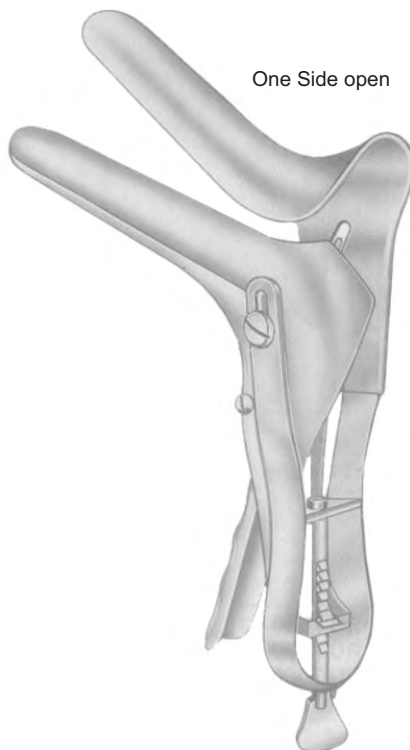
Nott

	a	b
	mm	mm
Ai 29-8016-01	90	30
Ai 29-8016-02	110	30



Seyffert

	a	b
	mm	mm
Ai 29-8017-01	100	17
Ai 29-8017-02	110	33



One Side open

Seyffert

	a	b
	mm	mm
Ai 29-8018-00	110	33



SAKURAI'S

Ai 29-8018-01	(LL)
Ai 29-8018-02	(L)
Ai 29-8018-03	(M)
Ai 29-8018-04	(S)





Sims (single ended)
 Ai 29-8019-01 63 x 32 mm
 Ai 29-8019-02 76 x 32 mm
 Ai 29-8019-03 89 x 38 mm



Sims (double ended)
 Ai 29-8020-01 65 x 25 mm (70 x 30 mm)
 Ai 29-8020-02 70 x 35 mm (70 x 35 mm)
 Ai 29-8020-03 85 x 35 mm (90 x 40 mm)
 Ai 29-8020-04 100 x 35 mm x 40 mm
 Ai 29-8020-05 120 x 35 mm x 40 mm



SIMS
 Ai 29-8020-11 60 x 25mm
 Ai 29-8020-12 70 x 30mm
 Ai 29-8020-13 80 x 35mm



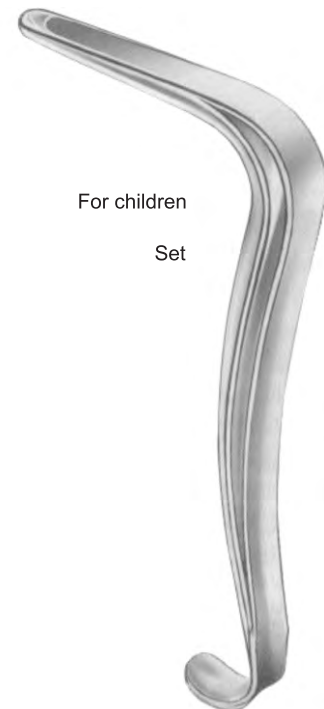
Jackson

	Fig.	a mm	b mm
Ai 29-8021-01	1	75 X 35	
Ai 29-8021-02	2	90 X 35	
Ai 29-8021-03	3	100 X 35	
Ai 29-8021-04	4	75 X 40	
Ai 29-8021-05	5	90 x 40	
Ai 29-8021-06	6	100 x 40	

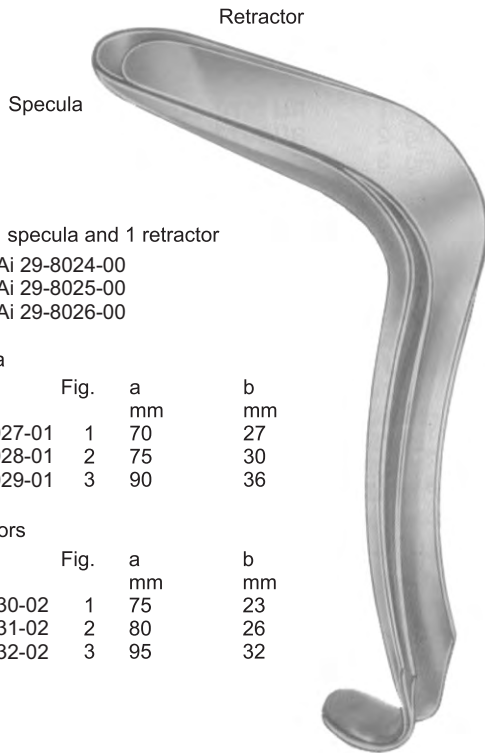


Eastman

	Fig.	a mm	b mm
Ai 29-8022-01	1	75 X 35	
Ai 29-8022-02	2	90 X 35	
Ai 29-8022-03	3	100 X 35	
Ai 29-8022-04	4	75 X 40	
Ai 29-8022-05	5	90 x 40	
Ai 29-8022-06	6	100 x 40	



For children
 Set
Kristeller
 Ai 29-8023-00
 70x15 mm



Retractor

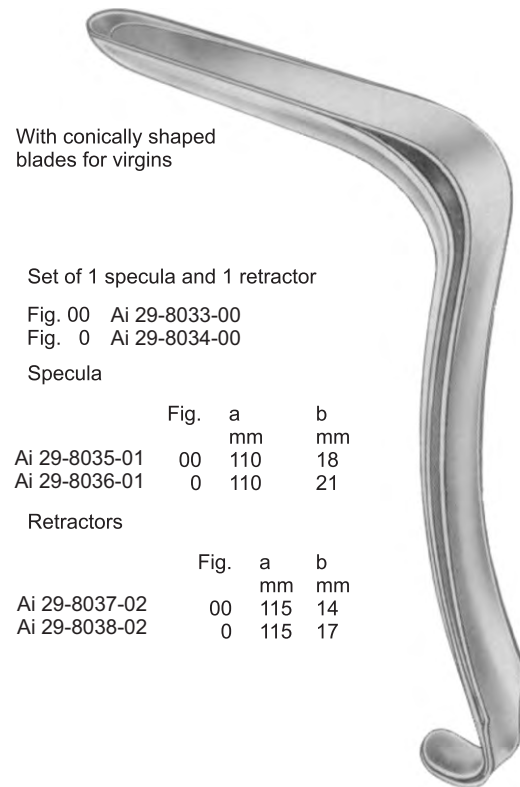
Specula

Set of 1 specula and 1 retractor
 Fig. 1 Ai 29-8024-00
 Fig. 2 Ai 29-8025-00
 Fig. 3 Ai 29-8026-00

Specula	Fig.	a mm	b mm
Ai 29-8027-01	1	70	27
Ai 29-8028-01	2	75	30
Ai 29-8029-01	3	90	36

Retractors	Fig.	a mm	b mm
Ai 29-8030-02	1	75	23
Ai 29-8031-02	2	80	26
Ai 29-8032-02	3	95	32

Kristeller (Standard)



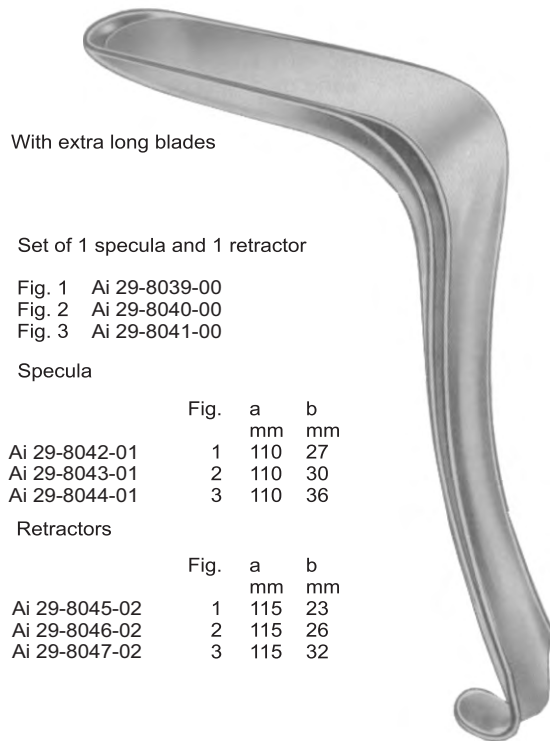
With conically shaped blades for virgins

Set of 1 specula and 1 retractor
 Fig. 00 Ai 29-8033-00
 Fig. 0 Ai 29-8034-00

Specula	Fig.	a mm	b mm
Ai 29-8035-01	00	110	18
Ai 29-8036-01	0	110	21

Retractors	Fig.	a mm	b mm
Ai 29-8037-02	00	115	14
Ai 29-8038-02	0	115	17

Kristeller



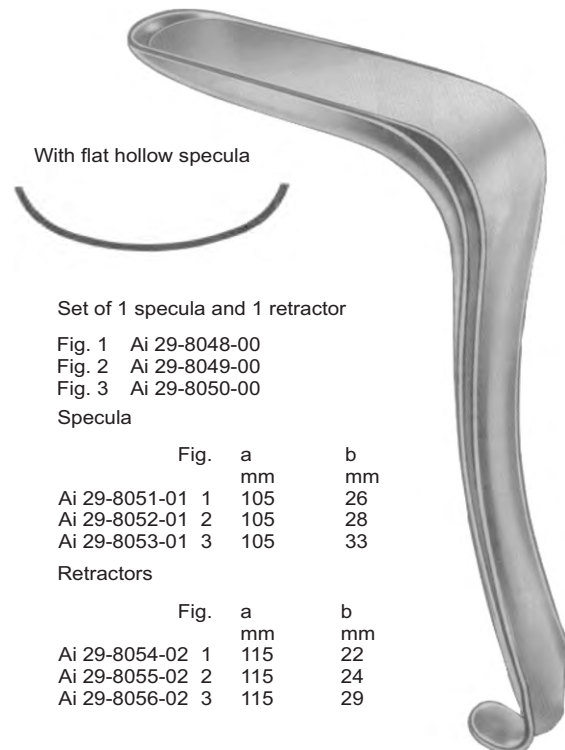
With extra long blades

Set of 1 specula and 1 retractor
 Fig. 1 Ai 29-8039-00
 Fig. 2 Ai 29-8040-00
 Fig. 3 Ai 29-8041-00

Specula	Fig.	a mm	b mm
Ai 29-8042-01	1	110	27
Ai 29-8043-01	2	110	30
Ai 29-8044-01	3	110	36

Retractors	Fig.	a mm	b mm
Ai 29-8045-02	1	115	23
Ai 29-8046-02	2	115	26
Ai 29-8047-02	3	115	32

Kristeller (Standard)



With flat hollow specula

Set of 1 specula and 1 retractor
 Fig. 1 Ai 29-8048-00
 Fig. 2 Ai 29-8049-00
 Fig. 3 Ai 29-8050-00

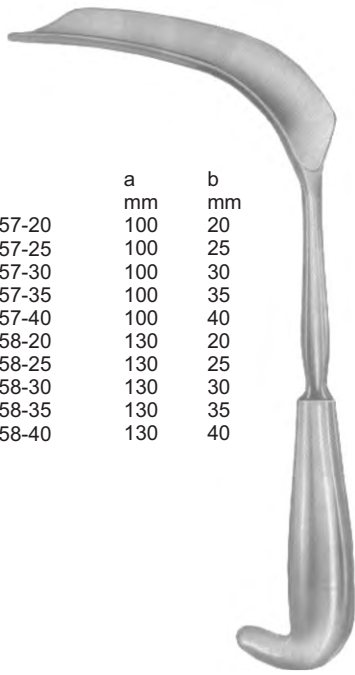
Specula	Fig.	a mm	b mm
Ai 29-8051-01	1	105	26
Ai 29-8052-01	2	105	28
Ai 29-8053-01	3	105	33

Retractors	Fig.	a mm	b mm
Ai 29-8054-02	1	115	22
Ai 29-8055-02	2	115	24
Ai 29-8056-02	3	115	29

Kristeller



	a	b
	mm	mm
Ai 29-8057-20	100	20
Ai 29-8057-25	100	25
Ai 29-8057-30	100	30
Ai 29-8057-35	100	35
Ai 29-8057-40	100	40
Ai 29-8058-20	130	20
Ai 29-8058-25	130	25
Ai 29-8058-30	130	30
Ai 29-8058-35	130	35
Ai 29-8058-40	130	40



Matzenauer



Braun
 Ai 29-8059-18
 18 cm/7"
 56x13 mm



Braun
 Ai 29-8060-18
 18 cm/7"
 60x10 mm



Ulrich
 Ai 29-8061-19
 19.5 cm/7 1/2"
 80x20 mm



Ai 29-8062-19
 19 cm/7 1/2"
 85x17 mm

Set

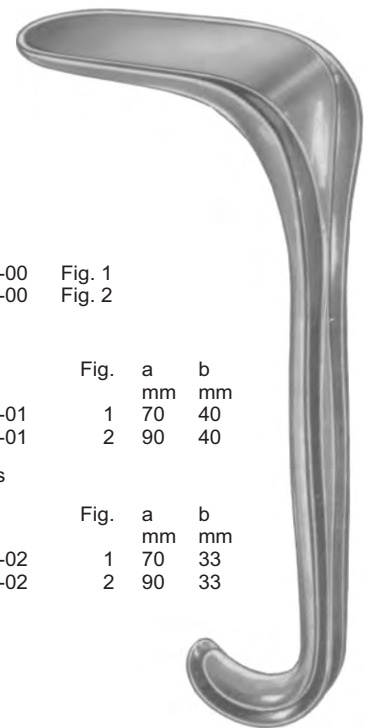
Ai 29-8063-00	Fig. 1
Ai 29-8064-00	Fig. 2

Specula

	Fig.	a	b
		mm	mm
Ai 29-8065-01	1	70	40
Ai 29-8066-01	2	90	40

Retractors

	Fig.	a	b
		mm	mm
Ai 29-8067-02	1	70	33
Ai 29-8068-02	2	90	33



Kallmorgen



Specula

	Fig.	a	b
	Set	mm	mm
Ai 29-8069-00	1	100	13/23
Ai 29-8069-01	2	100	16/30

Retractors

	Fig.	a	b
	Set	mm	mm
Ai 29-8070-00	1	100	11/21
Ai 29-8070-01	2	100	14/27

Fig. a b

	Fig.	a	b
	mm	mm	mm
Ai 29-8071-01	1	75	45
Ai 29-8071-02	2	90	45
Ai 29-8071-03	3	110	45

Ai 29-8072-01	75 x 280mm
Ai 29-8072-02	90 x 280mm
Ai 29-8072-03	100 x 280mm
Ai 29-8072-04	115 x 280mm

Doyen

Doyen
 Hollow handle 28cm/11"

extra large pattern

Ai 29-8073-14
 140 x 30mm

Ai 29-8074-13
 135 x 36mm

Ai 29-8074-14
 140 x 36mm

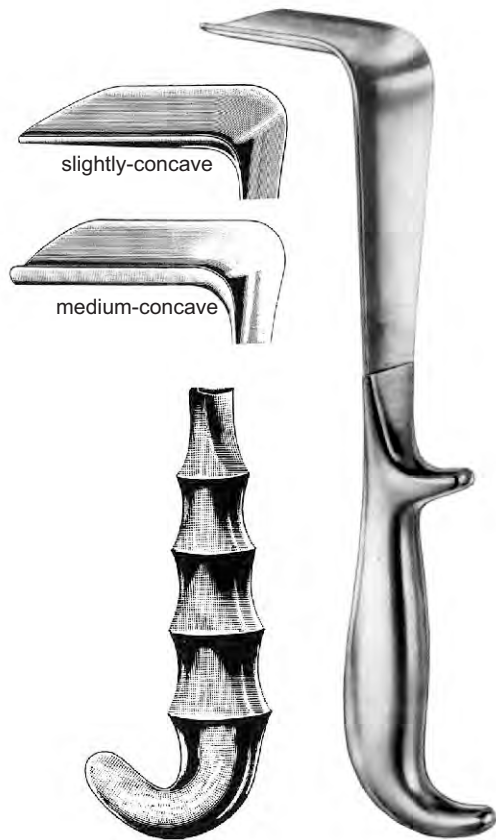
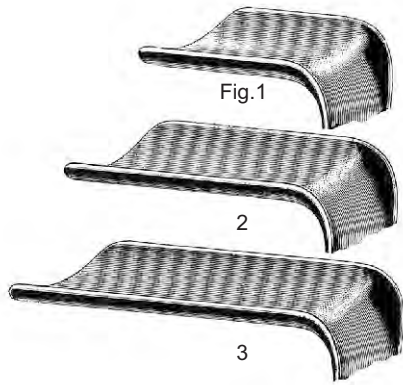
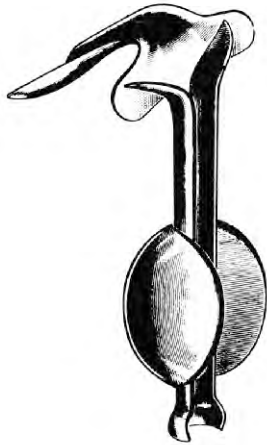


Fig	DOYEN FG		DOYEN		
	mm	mm	slightly-concave	slightly-concave	medium-concave
1	55	35	Ai 29-8075-11	Ai 29-8075-01	Ai 29-8078-01
2	85	35	Ai 29-8075-12	Ai 29-8075-02	Ai 29-8078-02
3	115	35	Ai 29-8075-13	Ai 29-8075-03	Ai 29-8078-03
1	55	45	Ai 29-8076-11	Ai 29-8076-01	Ai 29-8079-01
2	85	45	Ai 29-8076-12	Ai 29-8076-02	Ai 29-8079-02
3	115	45	Ai 29-8076-13	Ai 29-8076-03	Ai 29-8079-03
1	55	60	Ai 29-8077-11	Ai 29-8077-01	Ai 29-8080-01
2	85	60	Ai 29-8077-12	Ai 29-8077-02	Ai 29-8080-02
3	115	60	Ai 29-8077-13	Ai 29-8077-03	Ai 29-8080-03

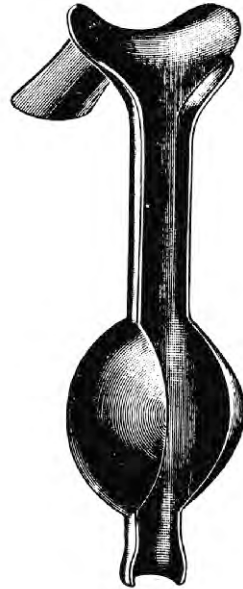
DOYEN
 Ai 29-8080-11 75 x 45mm
 Ai 29-8080-12 90 x 45mm
 Ai 29-8080-13 110 x 45mm

Doyen
 25 cm/10"

	a	b
	mm	mm
Ai 29-8081-01	60	30
Ai 29-8081-02	70	30
Ai 29-8081-03	80	30



AUVARD
 Ai 29-8082-01 80 x 38mm 2 lbs
 Ai 29-8082-02 80 x 38mm 2.5 lbs
 Ai 29-8082-03 80 x 38mm 3 lbs

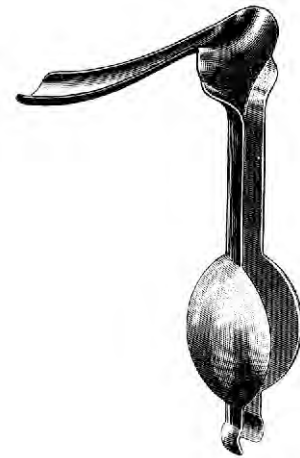


AUVARD
 Ai 29-8082-00 68 x 40mm 3 lbs

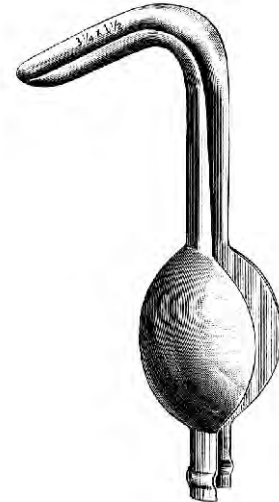


80 x 38 mm

AUVARD
 Ai 29-8082-04 2.5 lbs
 Ai 29-8082-05 3 lbs



Steiner-Auvard
 Ai 29-8083-01 140 x 35mm 2.5 lbs
 Ai 29-8083-02 140 x 35mm 2.5 lbs
 laser pattern



Henrotin
 Ai 29-8083-03 80 x 35mm 3 lbs
 30° blade angled down



Landau

	a	b
	mm	mm
Ai 29-8084-01	105	28
Ai 29-8084-02	105	38



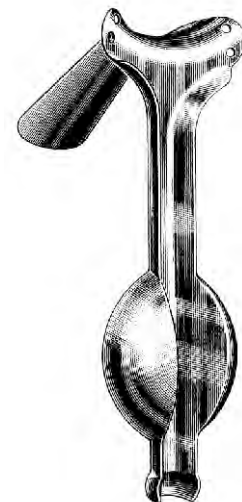
Dunkel
 Ai 29-8084-22

95 x 45 cm



Breisky

	a	b
	mm	mm
Ai 29-8085-20	100	20
Ai 29-8085-25	100	25
Ai 29-8085-30	100	30
Ai 29-8085-35	100	35
Ai 29-8085-40	100	40
Ai 29-8086-20	130	20
Ai 29-8086-25	130	25
Ai 29-8086-30	130	30
Ai 29-8086-35	130	35
Ai 29-8086-40	130	40
Ai 29-8087-20	160	20
Ai 29-8087-25	160	25
Ai 29-8087-30	160	30
Ai 29-8087-35	160	35
Ai 29-8087-40	160	40
Ai 29-8088-20	180	20
Ai 29-8088-25	180	25
Ai 29-8088-30	180	30
Ai 29-8088-35	180	35
Ai 29-8088-40	180	40
Ai 29-8088-50	155	40



Berlind-Auvard
 Ai 29-8083-04
 105 x 40mm 2.5 lbs





A
Ai 29-8089-00
handle only



70 x 30mm
Ai 29-8089-01



80 x 35mm
Ai 29-8089-02



90 x 35mm
Ai 29-8089-03



100 x 35mm
Ai 29-8089-04



80 x 30mm
Ai 29-8089-05



85 x 33mm
Ai 29-8089-06



100 x 35mm
Ai 29-8089-07



110 x 42mm
Ai 29-8089-08



B
Ai 29-8089-10
handle only

BOZEMANN

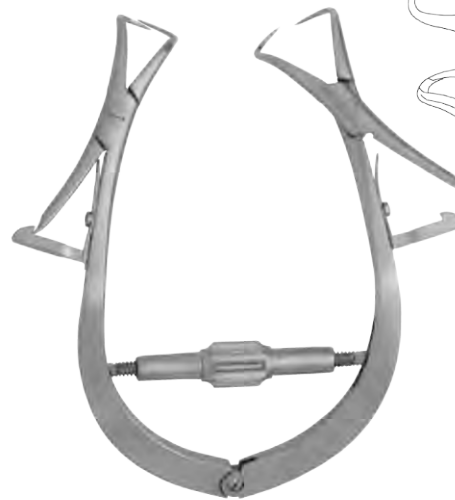
Ai 29-8089-20 compl. set with handle A, B and 8 blades
Ai 29-8089-30 compl. set with handle A and 8 blades
Ai 29-8089-40 compl. set with handle B and 8 blades



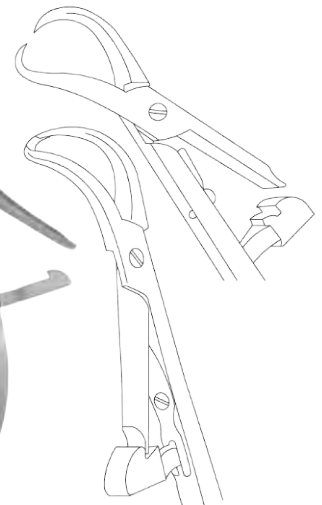
Friedman
Ai 29-8090-20
10 cm/4"

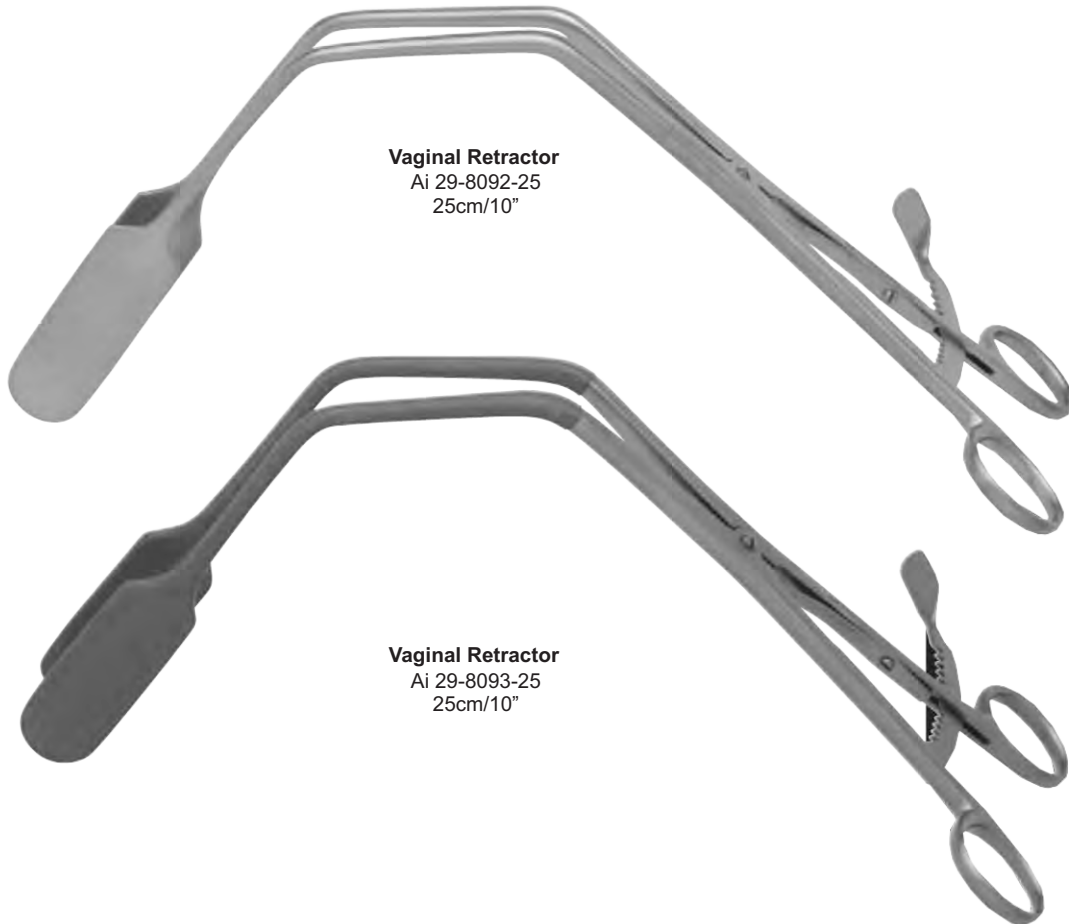
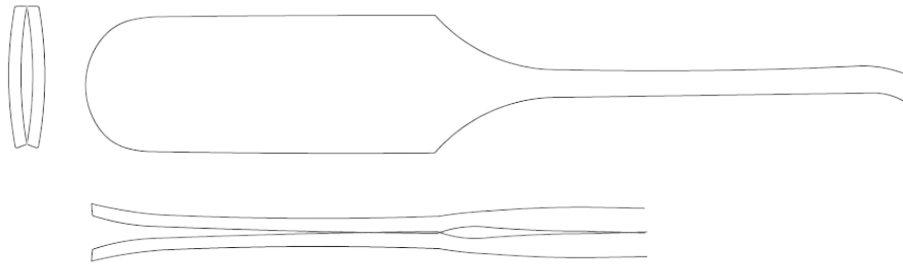


Comyn Berkeley
Vulva self retaining
Ai 29-8090-15
15.5cm/6"



Joll
Thyroid self retaining
Ai 29-8091-15
15.5cm/6"





Vaginal Retractor
Ai 29-8092-25
25cm/10"

Vaginal Retractor
Ai 29-8093-25
25cm/10"





Scherbak
 Ai 29-8094-00 Complete
 Ai 29-8094-10 Handle only



Ai 29-8094-01
 80x30 mm



Ai 29-8094-02
 85x35 mm



Ai 29-8094-03
 90x40 mm



Ai 29-8094-04
 55x40/60 mm



Ai 29-8094-05
 70x45/70 mm

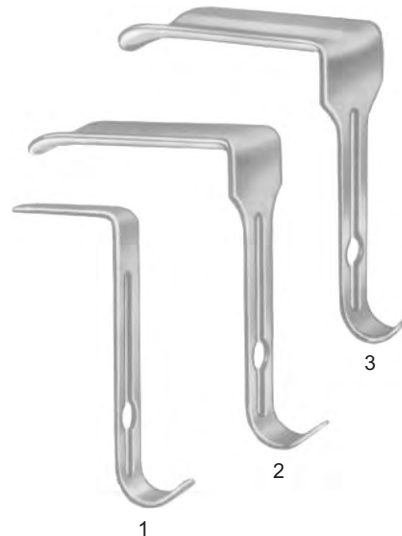


	Fig.	a mm	b mm
Ai 29-8095-01	1	45	17
Ai 29-8095-02	2	90	37
Ai 29-8095-03	3	90	45



O'Sullivan-O'Connor
 Ai 29-8095-00
 Complete



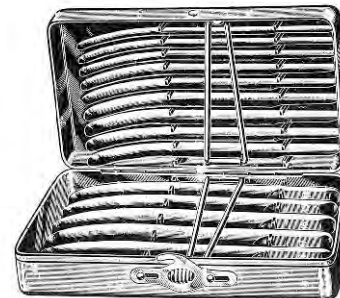
Hegar
 single ended
 18.5 cm long

mm Ø			mm dia.
1.0	Ai 29-8096-01	Ai 29-8096-51	1.5
2.0	Ai 29-8096-02	Ai 29-8096-52	2.5
3.0	Ai 29-8096-03	Ai 29-8096-53	3.5
4.0	Ai 29-8096-04	Ai 29-8096-54	4.5
5.0	Ai 29-8096-05	Ai 29-8096-55	5.5
6.0	Ai 29-8096-06	Ai 29-8096-56	6.5
7.0	Ai 29-8096-07	Ai 29-8096-57	7.5
8.0	Ai 29-8096-08	Ai 29-8096-58	8.5
9.0	Ai 29-8096-09	Ai 29-8096-59	9.5
10.0	Ai 29-8096-10	Ai 29-8096-60	10.5
11.0	Ai 29-8096-11	Ai 29-8096-61	11.5
12.0	Ai 29-8096-12	Ai 29-8096-62	12.5
13.0	Ai 29-8096-13	Ai 29-8096-63	13.5
14.0	Ai 29-8096-14	Ai 29-8096-64	14.5
15.0	Ai 29-8096-15	Ai 29-8096-65	15.5
16.0	Ai 29-8096-16	Ai 29-8096-66	16.5
17.0	Ai 29-8096-17	Ai 29-8096-67	17.5
18.0	Ai 29-8096-18	Ai 29-8096-68	18.5
19.0	Ai 29-8096-19	Ai 29-8096-69	19.5
20.0	Ai 29-8096-20	Ai 29-8096-70	20.5
21.0	Ai 29-8096-21	Ai 29-8096-71	21.5
22.0	Ai 29-8096-22	Ai 29-8096-72	22.5
23.0	Ai 29-8096-23	Ai 29-8096-73	23.5
24.0	Ai 29-8096-24	Ai 29-8096-74	24.5
25.0	Ai 29-8096-25	Ai 29-8096-75	25.5
26.0	Ai 29-8096-26	Ai 29-8096-76	26.5
27.0	Ai 29-8096-27	Ai 29-8096-77	27.5
28.0	Ai 29-8096-28	Ai 29-8096-78	28.5
29.0	Ai 29-8096-29	Ai 29-8096-79	29.5
30.0	Ai 29-8096-30	Ai 29-8096-80	30.5



Pieces per set

Ai 29-8097-10	14	4 -17 mm
Ai 29-8097-20	26	1 - 26 mm
Ai 29-8097-30	30	1 - 30 mm



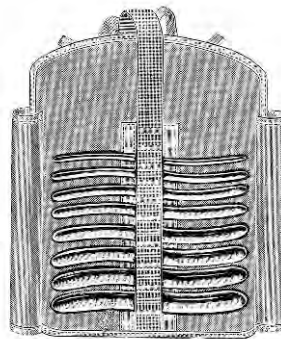
Pieces per set

Ai 29-8098-40	14	4 -17 mm
Ai 29-8098-50	26	1 - 26 mm
Ai 29-8098-60	30	1 - 30 mm



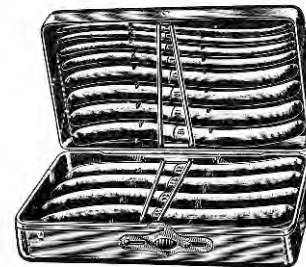
Hegar
 double ended
 20 cm long

Ø mm	
1/2	Ai 29-8099-02
3/4	Ai 29-8099-04
5/6	Ai 29-8099-06
7/8	Ai 29-8099-08
9/10	Ai 29-8099-10
11/12	Ai 29-8099-12
13/14	Ai 29-8099-14
15/16	Ai 29-8099-16
17/18	Ai 29-8099-18
19/20	Ai 29-8099-20
21/22	Ai 29-8099-22
23/24	Ai 29-8099-24
25/26	Ai 29-8099-26



Pieces per set set

Ai 29-8100-00	08	3/4 - 17/18 mm	Ai 29-8100-30
Ai 29-8100-01	13	1/2 - 25/26 mm	Ai 29-8100-31





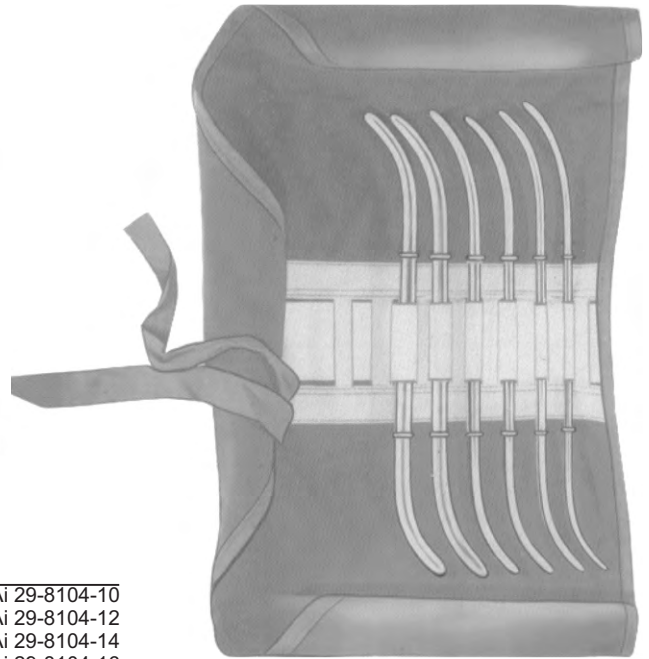
mm	
3/6	Ai 29-8102-03
4/7	Ai 29-8102-04
5/8	Ai 29-8102-05
6/9	Ai 29-8102-06
7/10	Ai 29-8102-07
8/11	Ai 29-8102-08
9/12	Ai 29-8102-09
10/13	Ai 29-8102-10
11/14	Ai 29-8102-11
12/15	Ai 29-8102-12
13/16	Ai 29-8102-13
14/17	Ai 29-8102-14
15/18	Ai 29-8102-15
16/19	Ai 29-8102-16
17/20	Ai 29-8102-17
18/21	Ai 29-8102-18

Hawkin Ambler
 Ai 29-8101-12 Set of 12 3/6 - 14/17
 Ai 29-8101-16 Set of 16 3/6 - 18/21
 17 cm long



Hank
 Ai 29-8103-30

mm	
9/10	Ai 29-8104-10
11/12	Ai 29-8104-12
13/14	Ai 29-8104-14
15/16	Ai 29-8104-16
17/18	Ai 29-8104-18
19/20	Ai 29-8104-20

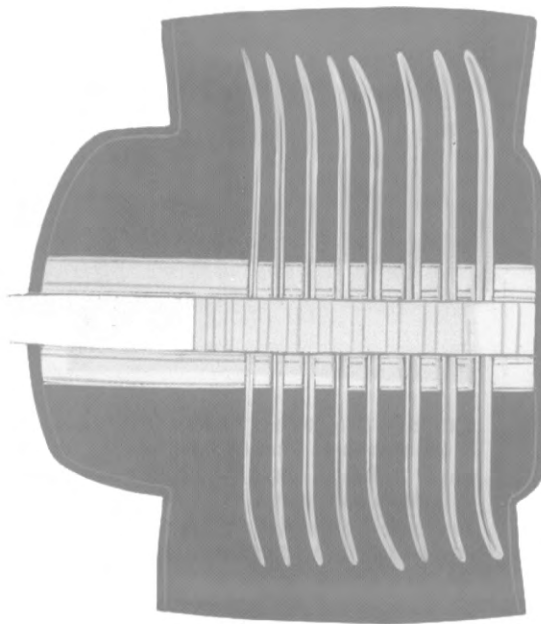


Set
 Ai 29-8105-00
 double ended
 27 cm



mm	
13/15	Ai 29-8106-15
17/19	Ai 29-8106-19
21/23	Ai 29-8106-23
25/27	Ai 29-8106-27
29/31	Ai 29-8106-31
33/35	Ai 29-8106-35
37/39	Ai 29-8106-39
41/43	Ai 29-8106-43

Pratt



Set
 Ai 29-8106-00
 double ended
 29 cm



Jolly
 Ai 29-8107-00 set of 5
 Ai 29-8107-01 3-7 mm dia
 Ai 29-8107-02 5-9 mm dia
 Ai 29-8107-03 7-12 mm dia
 Ai 29-8107-04 9-15 mm dia
 Ai 29-8107-05 12-18 mm dia

Tip 4 mm



Sims
 32 cm/12½"
 cm
 Ai 29-8108-01 s/s
 cm / in
 Ai 29-8108-02 s/s
 Ai 29-8108-03 c/p



Martin (Simpson)
 32 cm/12½"
 cm
 Ai 29-8109-01 s/s
 cm / in
 Ai 29-8109-02 s/s
 Ai 29-8109-03 c/p



Valleix
 Ai 29-8110-25
 25 cm/10"



Collin
 Ai 29-8111-28
 28 cm/11"

Uterine Depressor



Braun
 Ai 29-8112-28
 28 cm/11"

Rigid

Malleable





SIMS
Ai 29-8113-26
26.0cm



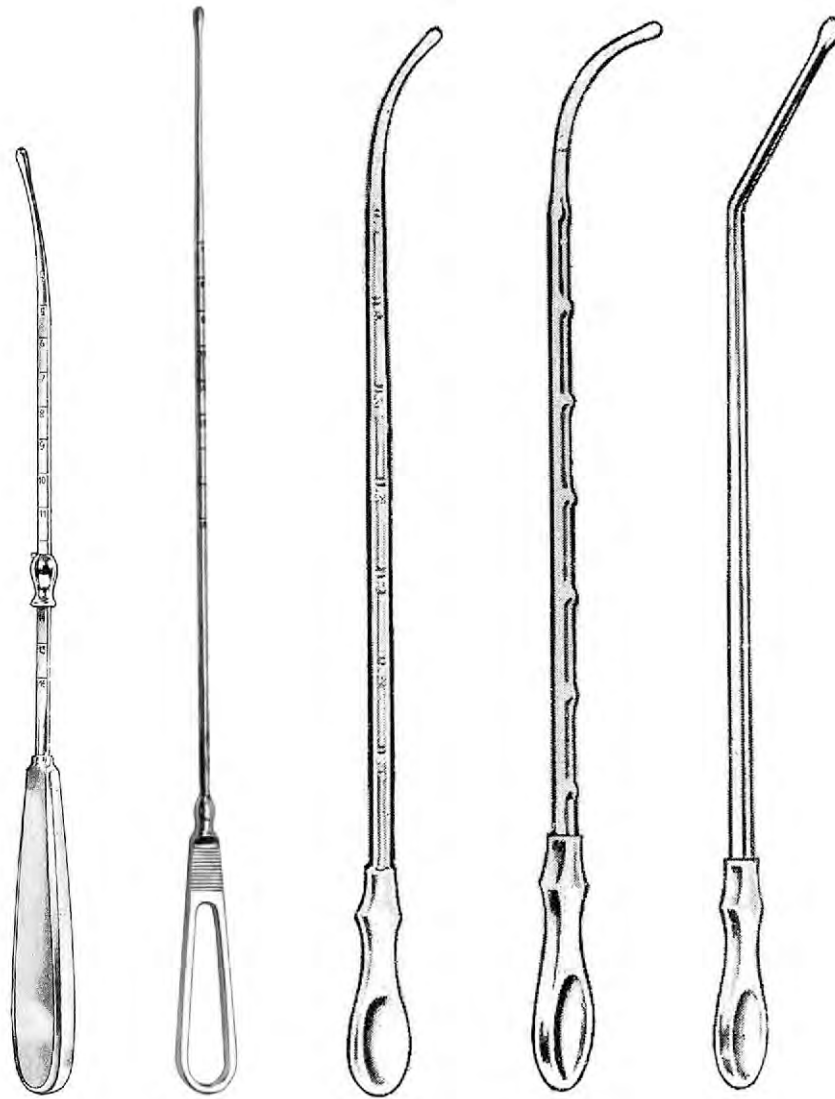
FANO
Ai 29-8114-22
22.0cm



RAPID
Ai 29-8115-01 200 x 8mm
Ai 29-8115-02 250 x 10mm
Ai 29-8115-03 250 x 12mm



SIMS
Ai 29-8116-27
27.0cm



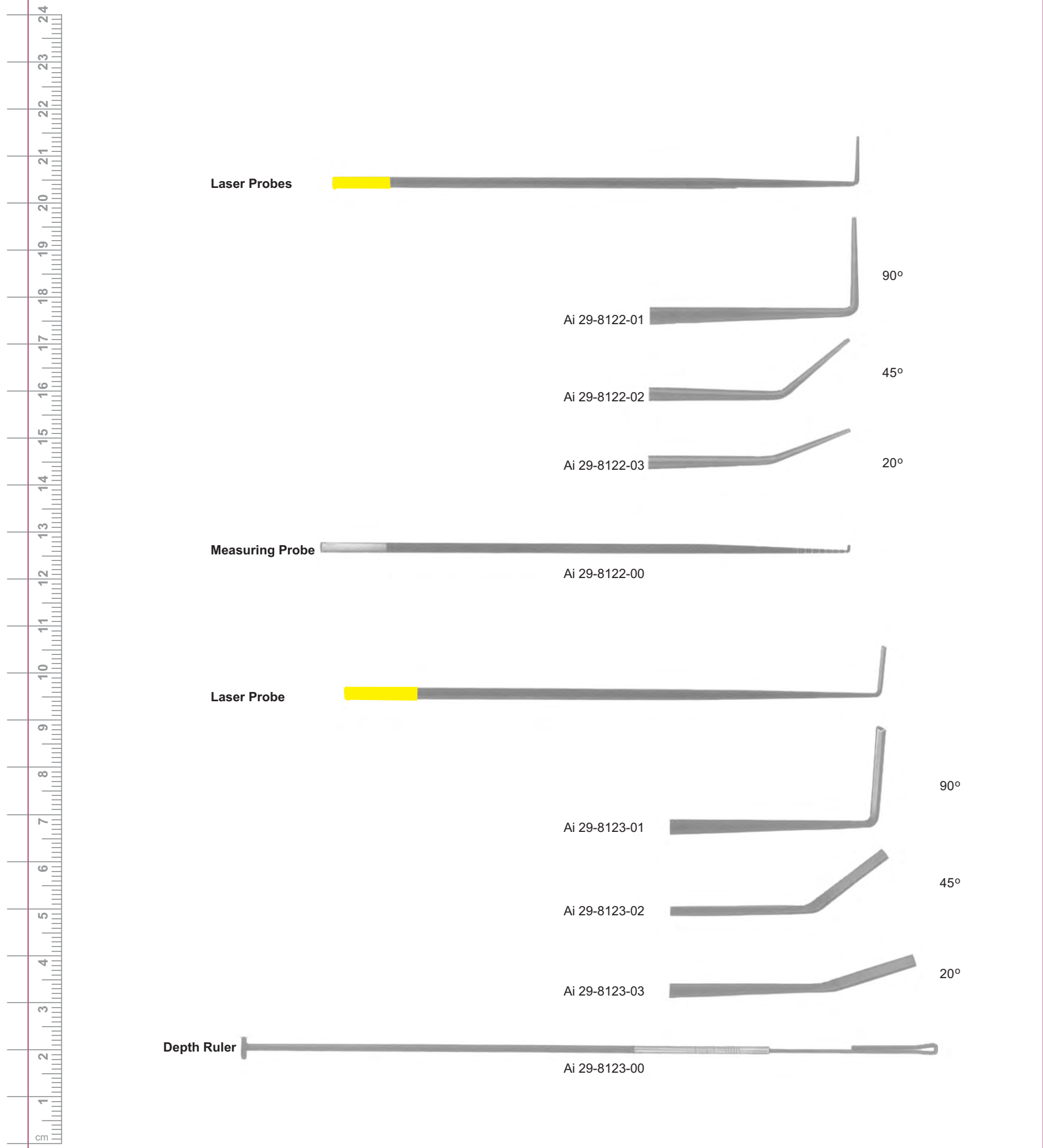
VALLEIX
 Ai 29-8117-25
 25.0cm

Ai 29-8118-30
 30.5cm

GALABIN
 Ai 29-8119-32
 32.0cm

HORROCKS
 Ai 29-8120-32
 32.0cm

SIMPSON
 Ai 29-8121-32
 32.0cm



Laser Probes

Ai 29-8122-01

90°

Ai 29-8122-02

45°

Ai 29-8122-03

20°

Measuring Probe

Ai 29-8122-00

Laser Probe

Ai 29-8123-01

90°

Ai 29-8123-02

45°

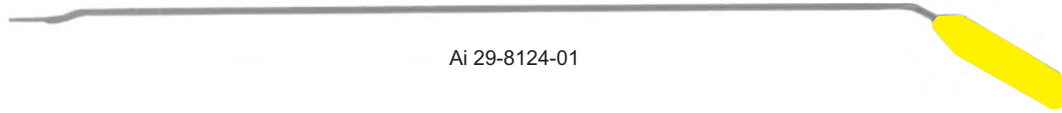
Ai 29-8123-03

20°

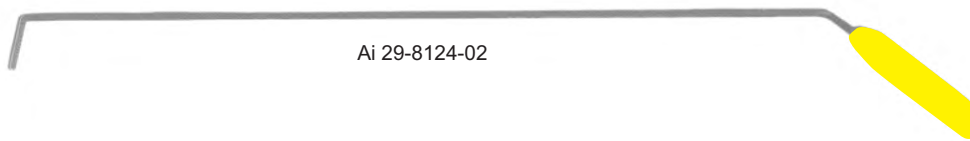
Depth Ruler

Ai 29-8123-00

Measuring Instruments



Ai 29-8124-01



Ai 29-8124-02

Hooks



Ai 29-8125-01



Ai 29-8125-02 Emmet



Ai 29-8125-03



Ai 29-8126-01



Ai 29-8127-02





Ayre
Ai 29-8128-23
23 cm/9"



Simon
Ai 29-8129-22
22 cm/8¾"



Simon
Ai 29-8130-22
22 cm/8¾"



Emmet
22 cm/8¾"



Ai 29-8131-01



Ai 29-8131-02



Ai 29-8131-03



Ai 29-8131-04



Ai 29-8131-05



Ai 29-8132-24
24.0cm



Doyen
Ai 29-8132-17 T-Handle
Ai 29-8132-18 Loop-Handle
17 cm/6¾"



Doyen
Ai 29-8133-17 T-Handle
Ai 29-8133-18 Loop-Handle
17 cm/6¾"



Segond
Ai 29-8134-27
27 cm/10½"

Secretion Spoon



Ai 29-8135-27
 27 cm/10½"



Muenchen
 27 cm/10½"



Ai 29-8136-04
 4 mm



Ai 29-8136-05
 5 mm



Randall
 24 cm/9½"

4 mmØ

- Ai 29-8137-01 1 mm
- Ai 29-8137-02 2 mm
- Ai 29-8137-03 3 mm
- Ai 29-8137-04 4 mm



Novak
 23 cm/9"

- Ai 29-8138-01 1 mm
- Ai 29-8138-02 2 mm
- Ai 29-8138-03 3 mm
- Ai 29-8138-04 4 mm



Novak-Schoeckaert
 Ai 29-8139-24
 24 cm/9"





Kevorkian malleable
 Ai 29-8140-30 30 cm/12"
 Ai 29-8141-30 30 cm/12"



Kevorkian malleable
 Ai 29-8142-30 30 cm/12"
 Ai 29-8143-30 30 cm/12"



Townsend malleable
 Ai 29-8144-30 31 cm/12¼"
 Ai 29-8145-30 31 cm/12¼"



Duncan
 Ai 29-8146-31 31 cm/12¼"



Duncan
 Ai 29-8147-31 31 cm/12¼"



Goodell
 Ai 29-8148-34
 34 cm/13 1/2"

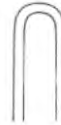


Kogan-Laser
 24 cm

Black Insulated



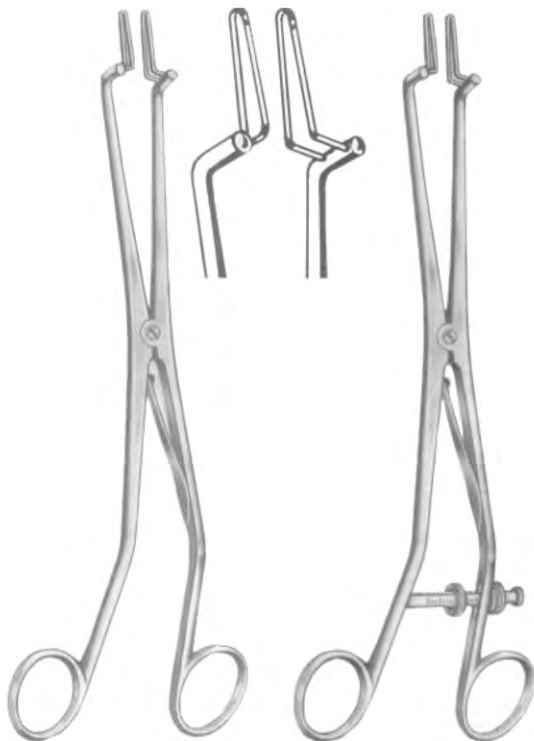
Ai 29-8149-28



Ai 29-8150-28

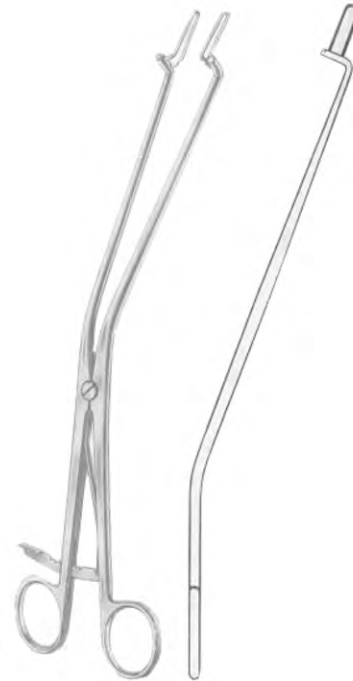


Ai 29-8151-28
 28 cm/11"



Kogan
 Ai 29-8152-24 24 cm
 Ai 29-8152-48 48 cm

Kogan
 Ai 29-8153-24 24 cm
 Ai 29-8153-48 48 cm



Kogan
 28 cm/11"



Ai 29-8154-28

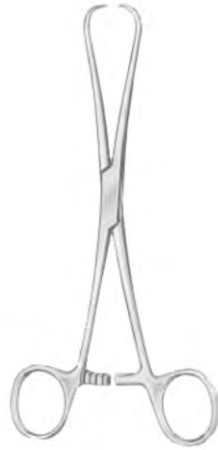


Ai 29-8155-28





Martin
 Ai 29-8156-27
 27 cm/10½"



Staude-Moore
 Ai 29-8157-17
 17 cm/6¾"



Barrett
 Ai 29-8158-18
 18 cm/7"



Schroeder
 Ai 29-8159-10
 25 cm/10"



Teale
 Ai 29-8159-18 18.0cm
 Ai 29-8159-23 23.0cm
 Ai 29-8159-25 25.0cm



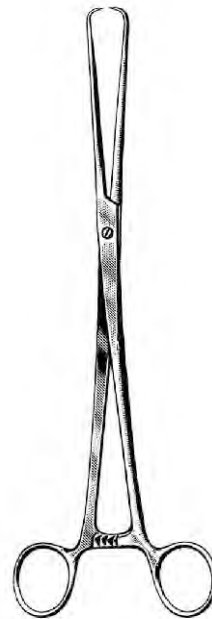
Braun
 Ai 29-8160-25
 25 cm/10"



Collin-Pozzi
 Ai 29-8161-25
 25 cm/10"



Pozzi
 Ai 29-8162-01
 25.5 cm/10¼"



Pozzi
 Ai 29-8162-02
 25.0cm

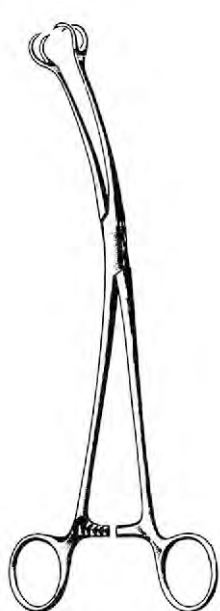


Duplay
 Ai 29-8163-28
 28 cm/11"

Amniotome for the
amnion Bladder



Skene
Ai 29-8164-24
24 cm/9½"



Skene
Ai 29-8164-23
23.0cm



Beacham
Ai 29-8165-26
26 cm/10¼"



Czerny
Ai 29-8166-20
20.5 cm/8¼"



Ai 29-8167-26
26 cm/10¼"



Henrotin
Ai 29-8167-20
20.0cm



Abel
Ai 29-8168-27
27.0cm



Schroeder
Ai 29-8168-23 23 cm
Ai 29-8168-24 24 cm
Ai 29-8168-26 26 cm
Straight



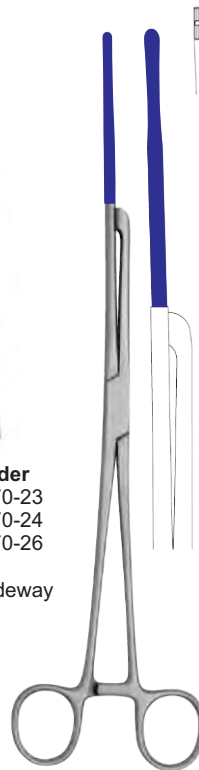
Schroeder
Ai 29-8169-23
Ai 29-8169-24
Ai 29-8169-26

Curved on Flat



Schroeder
Ai 29-8170-23
Ai 29-8170-24
Ai 29-8170-26

Curved Sideway



Atrauma
Ai 29-8171-29
Vulsellum Forcep
29cm/11 ½"



Luer
Ai 29-8172-30
Vulsellum Forcep
30.5cm/12"

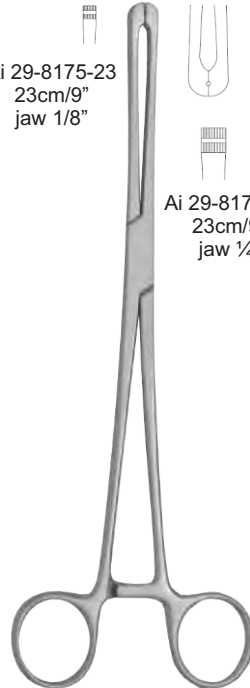




Atrauma
 Ai 29-8173-29
 29cm/11 1/2"



Bozeman
 Ai 29-8174-27
 27cm/10 1/2"

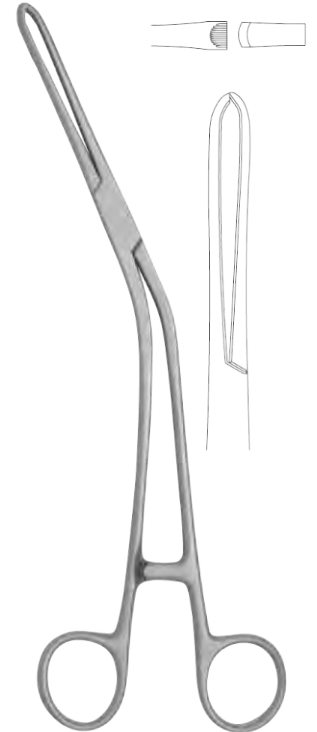


Ai 29-8175-23
 23cm/9"
 jaw 1/8"

Ai 29-8176-23
 23cm/9"
 jaw 1/4"



Rotunda
 Ai 29-8177-27
 27cm/10 1/2"



Bierer
 Ai 29-8178-24
 24cm/9 1/2"



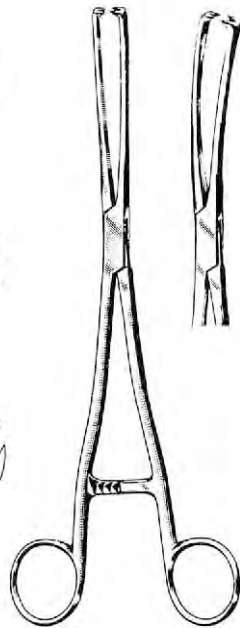
MUSEUX curved
 straight 24.0cm
 sideway



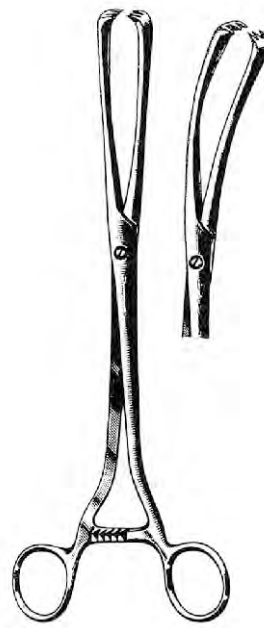
6mm

8mm

10mm



MUSEUX curved
 straight 24.0cm
 sideway



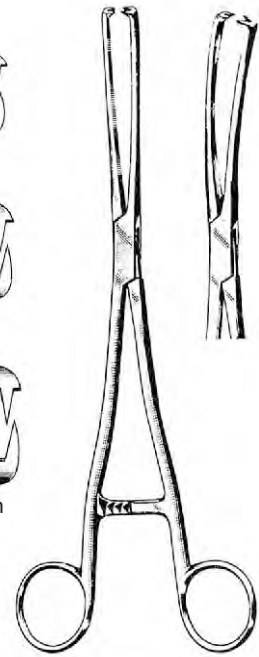
MUSEUX curved
 straight 26.0cm
 sideway



9mm

11mm

13mm



MUSEUX curved
 straight 26.0cm
 sideway

- | | | | | | | | | | | | |
|---------------|------|---------------|---------------|------|---------------|---------------|------|---------------|---------------|------|---------------|
| Ai 29-8179-06 | 6mm | Ai 29-8179-16 | Ai 29-8180-06 | 6mm | Ai 29-8180-16 | Ai 29-8181-09 | 9mm | Ai 29-8181-16 | Ai 29-8182-09 | 9mm | Ai 29-8182-16 |
| Ai 29-8179-08 | 8mm | Ai 29-8179-18 | Ai 29-8180-08 | 8mm | Ai 29-8180-18 | Ai 29-8181-11 | 11mm | Ai 29-8181-18 | Ai 29-8182-11 | 11mm | Ai 29-8182-18 |
| Ai 29-8179-10 | 10mm | Ai 29-8179-20 | Ai 29-8180-10 | 10mm | Ai 29-8180-20 | Ai 29-8181-13 | 13mm | Ai 29-8181-20 | Ai 29-8182-13 | 13mm | Ai 29-8182-20 |

For the amnion Bladder



Pratt
 Ai 29-8183-28
 28 cm/11"



Iowa
 Ai 29-8184-26
 26 cm/10¼"



Jacobs
 Straight Curved Sideview
 Ai 29-8185-21 Ai 29-8186-21
 21 cm/8¼"



Bonney Polypus
 Ai 29-8187-26
 24 cm/9 ½"



Kelly
 Ai 29-8188-32
 32 cm/12½"



Heywood-Smith
 Ai 29-8189-20
 20 cm/8"



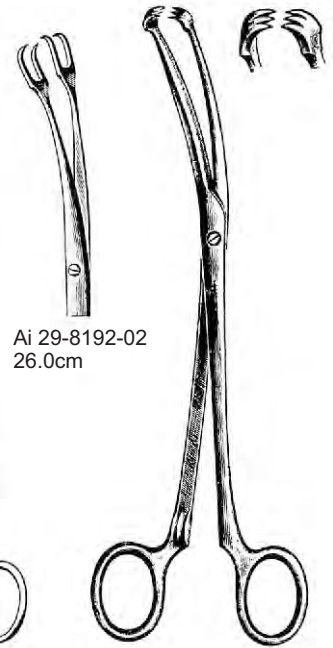
Heywood-Smith
 Ai 29-8190-25
 25 cm/10"



Noto
 Ai 29-8191-27
 27 cm/10½"



Schroeder
 Ai 29-8192-01
 26.0cm



Teale
 Ai 29-8193-18 18.0cm
 Ai 29-8193-23 23.0cm





Dartigues
 Ai 29-8194-27
 27 cm/10½"



Sommer
 Ai 29-8195-23
 23 cm/9"

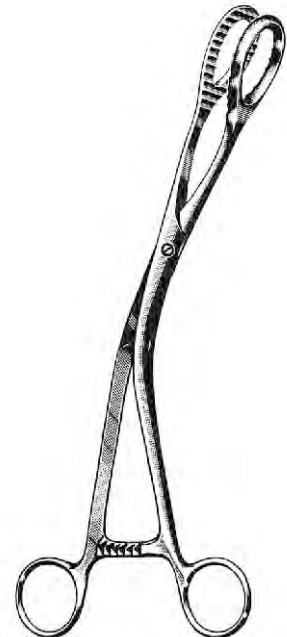


Collin
 Ai 29-8196-25
 25 cm/10"



Doyen
 Ai 29-8197-18 18 cm/7"
 Ai 29-8197-20 20 cm/8"

Ovarian Forceps



Pruesmann
 Ai 29-8197-27
 27.5cm



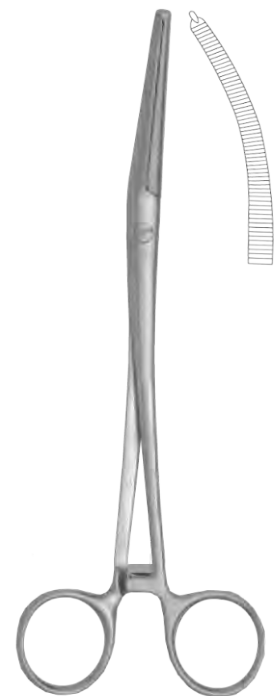
Bonney
 Ai 29-8198-27
 27 cm/11"



Bonney
 Ai 29-8199-27
 27 cm/10½"



Bonney
 Ai 29-8200-20
 20 cm/8"
 curved



Bonney Berkley
 Ai 29-8201-20
 20 cm/8"
 angled



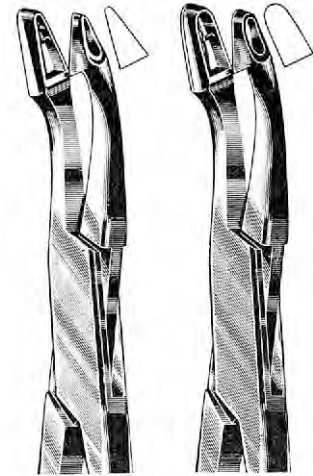
THOMS-GAYLOR
 Ai 29-8202-24
 24.0cm



THOMS-GAYLOR
 Ai 29-8203-22 22.0cm
 Ai 29-8203-24 24.0cm



VAN DOREN
 24.0cm



Ai 29-8204-01 Ai 29-8204-02



GELLHORN
 Ai 29-8205-23
 23.0cm



FAURE
 Ai 29-8206-21
 21.0cm

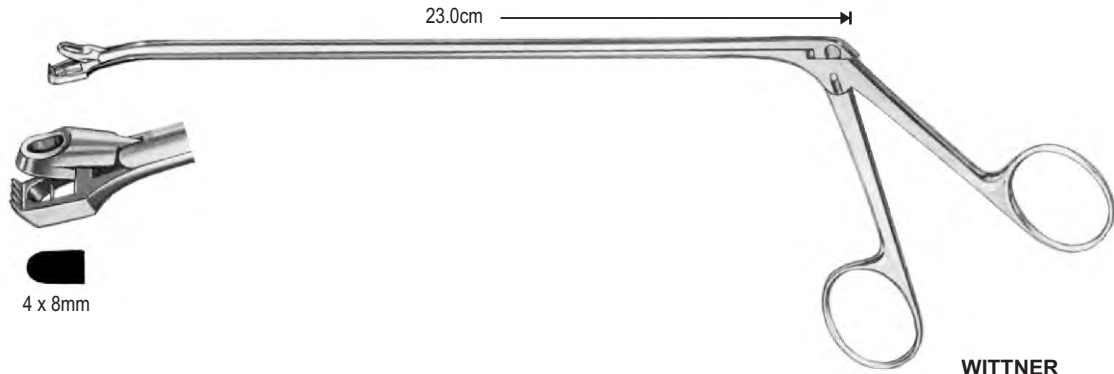


SCHUBERT
 Ai 29-8207-26
 26.0cm



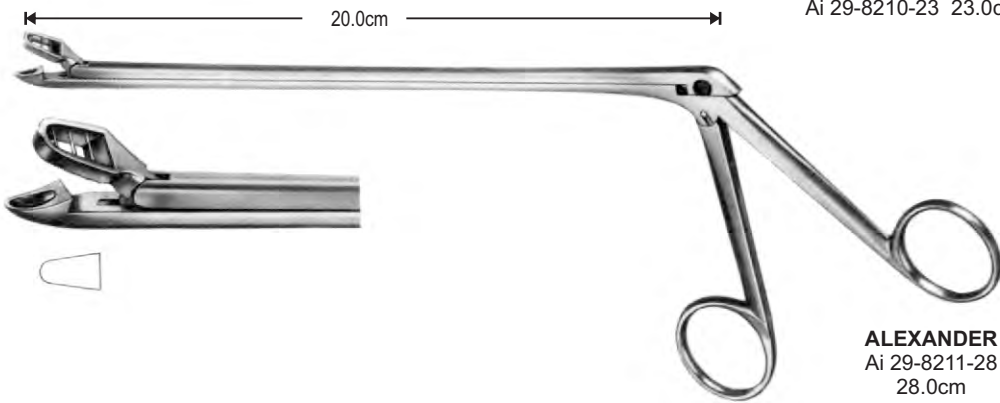
SCHUBERT
 Ai 29-8208-21 21.0cm
 Ai 29-8208-29 29.0cm





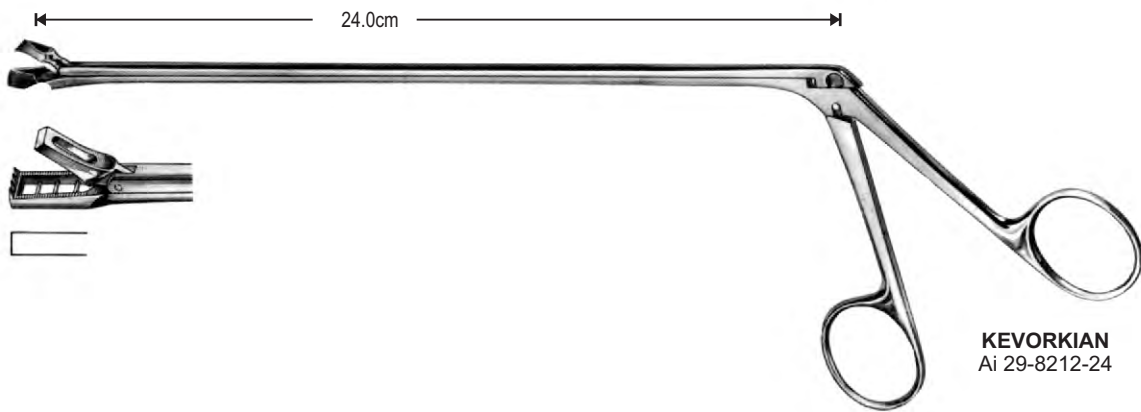
WITTNER

Ai 29-8209-23 23.0cm (straight)
 Ai 29-8210-23 23.0cm (angled)



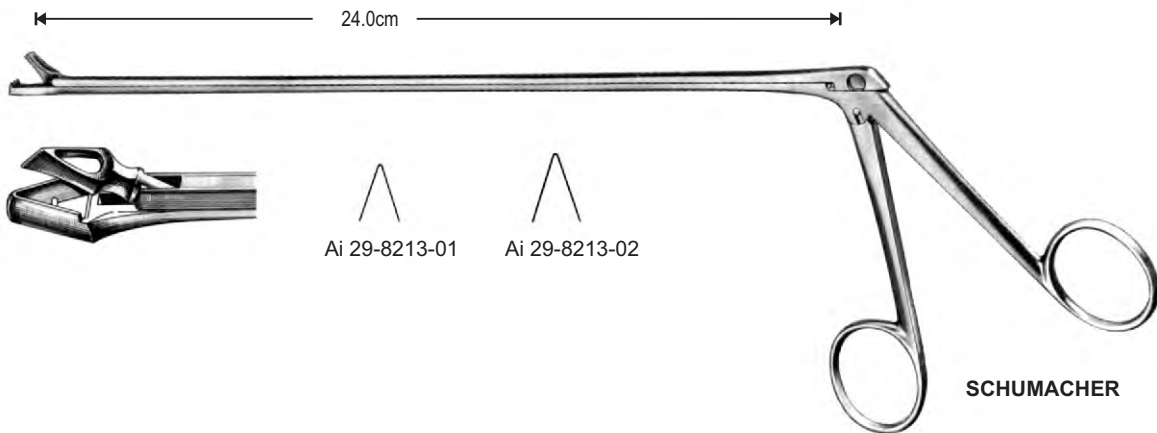
ALEXANDER

Ai 29-8211-28
 28.0cm



KEVORKIAN

Ai 29-8212-24



SCHUMACHER



2.3 x 4.2 mm



TOWNSEND-MINI
Ai 29-8214-00



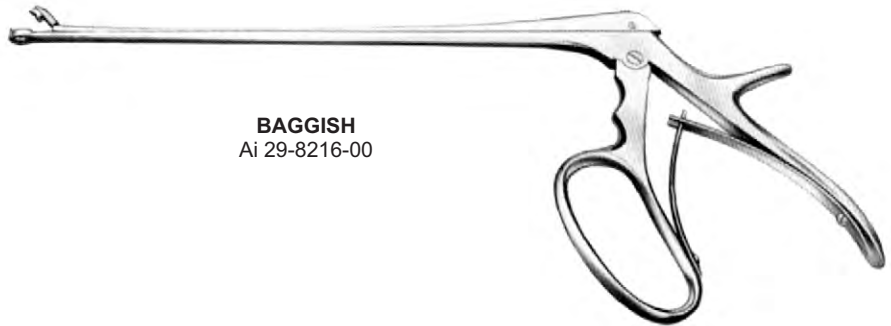
3 x 9.5 mm



TISCHLER-KEVORKIAN
Ai 29-8215-00



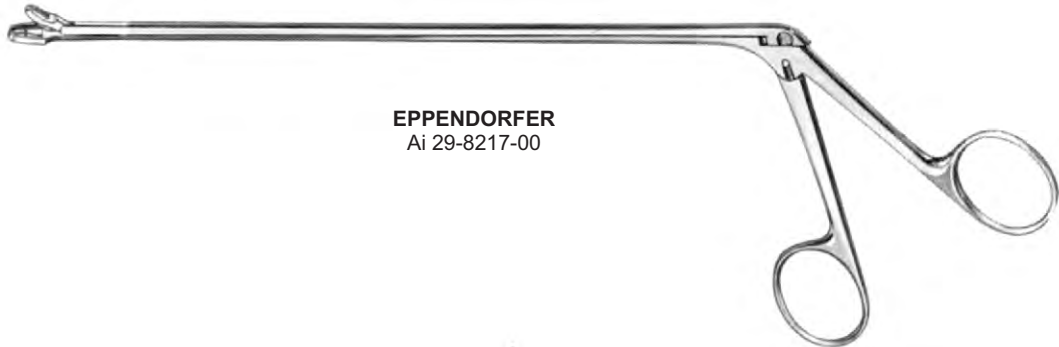
4 x 6.5 mm



BAGGISH
Ai 29-8216-00



4 x 8 mm

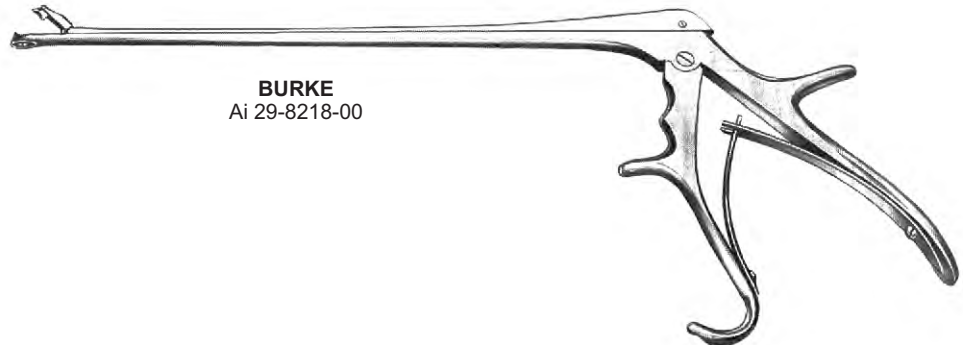


EPPENDORFER
Ai 29-8217-00





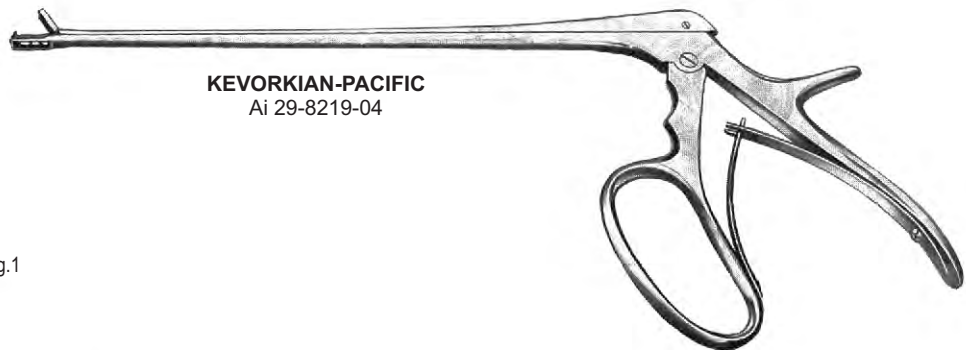
oval
7 x 5 mm



BURKE
Ai 29-8218-00



3 x 8 mm



KEVORKIAN-PACIFIC
Ai 29-8219-04



Fig.1

TISCHLER-MORGAN



Fig.3

oval ● 3.7 x 5 mm



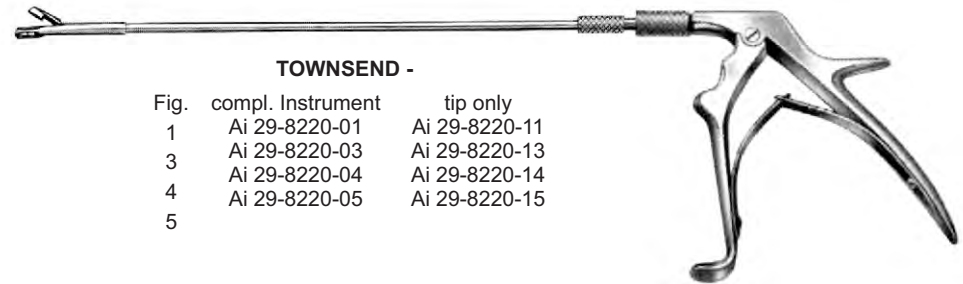
Fig.4

KEVORKIAN



Fig.5

mini



TOWNSEND -

Fig.	compl. Instrument	tip only
1	Ai 29-8220-01	Ai 29-8220-11
	Ai 29-8220-03	Ai 29-8220-13
3	Ai 29-8220-04	Ai 29-8220-14
4	Ai 29-8220-05	Ai 29-8220-15
5		

Ai 29-8220-99
handle only



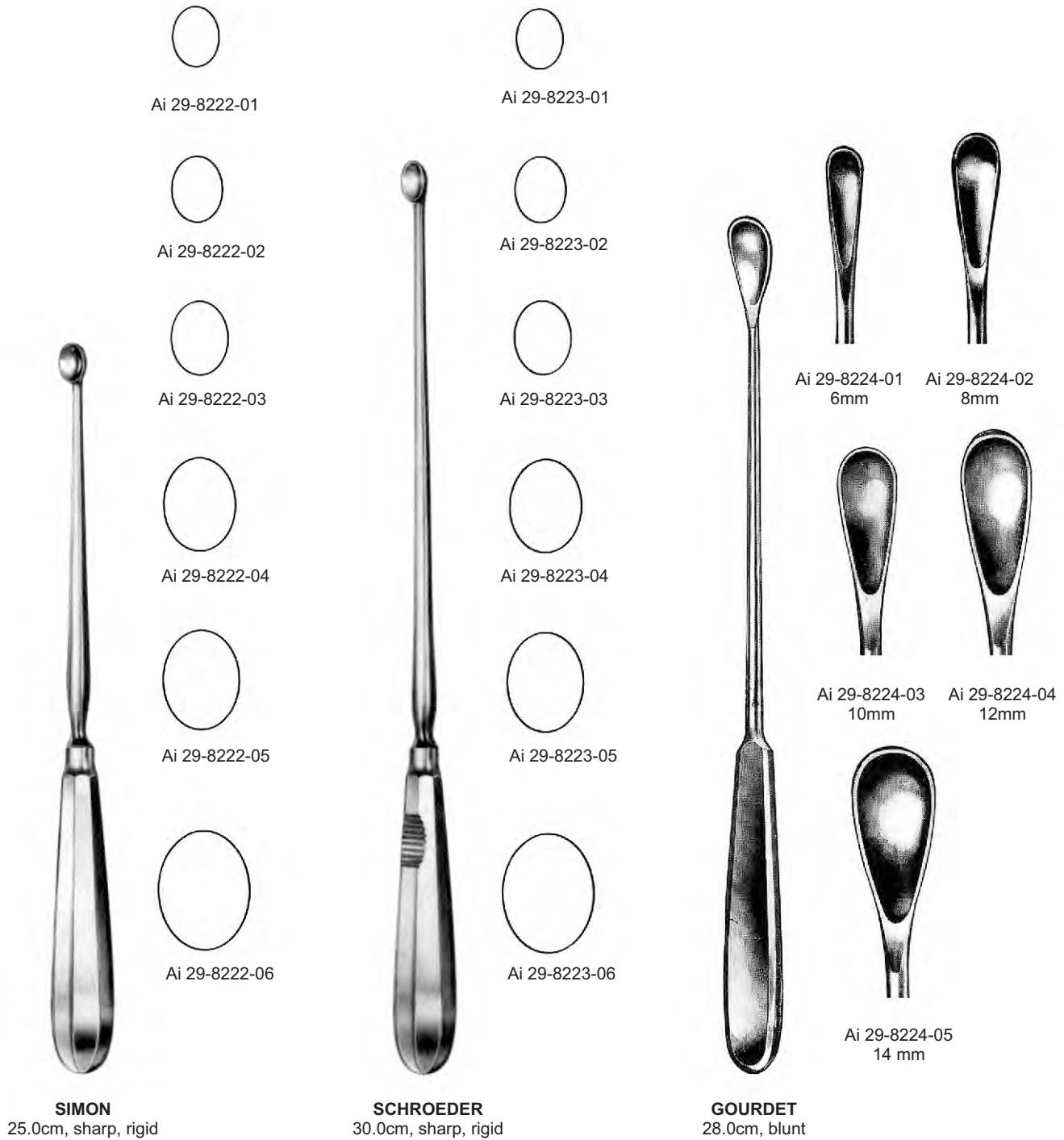
Tip only



SCHUMACHER
Ai 29-8221-00



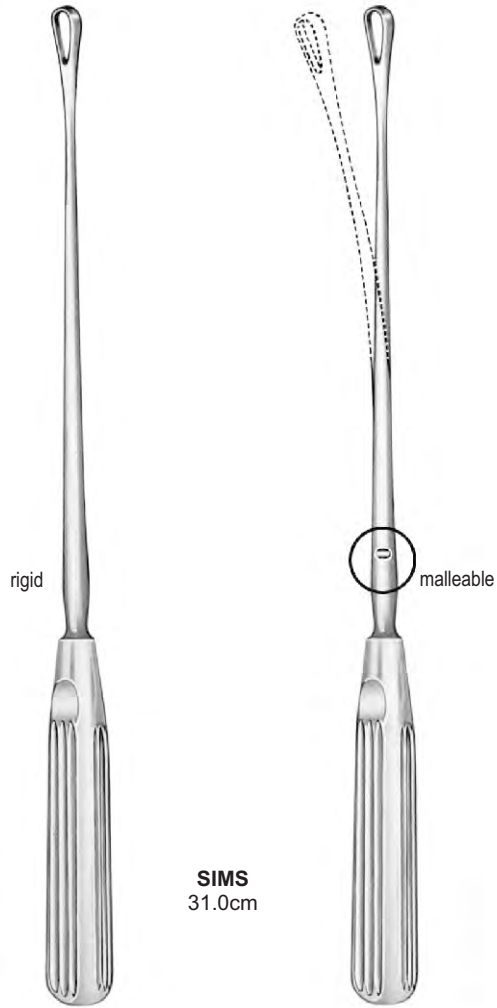
Ai 29-8221-01



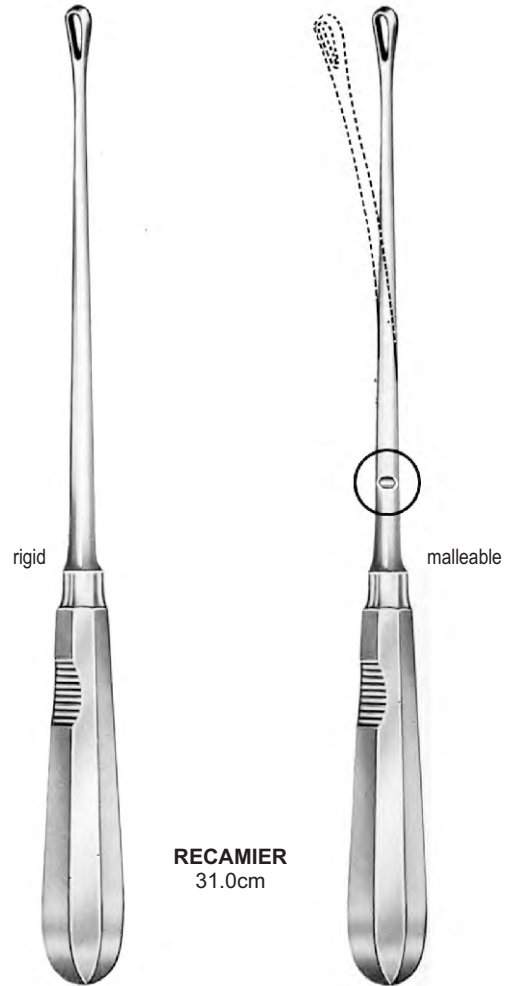
SIMON
 25.0cm, sharp, rigid

SCHROEDER
 30.0cm, sharp, rigid

GOURDET
 28.0cm, blunt



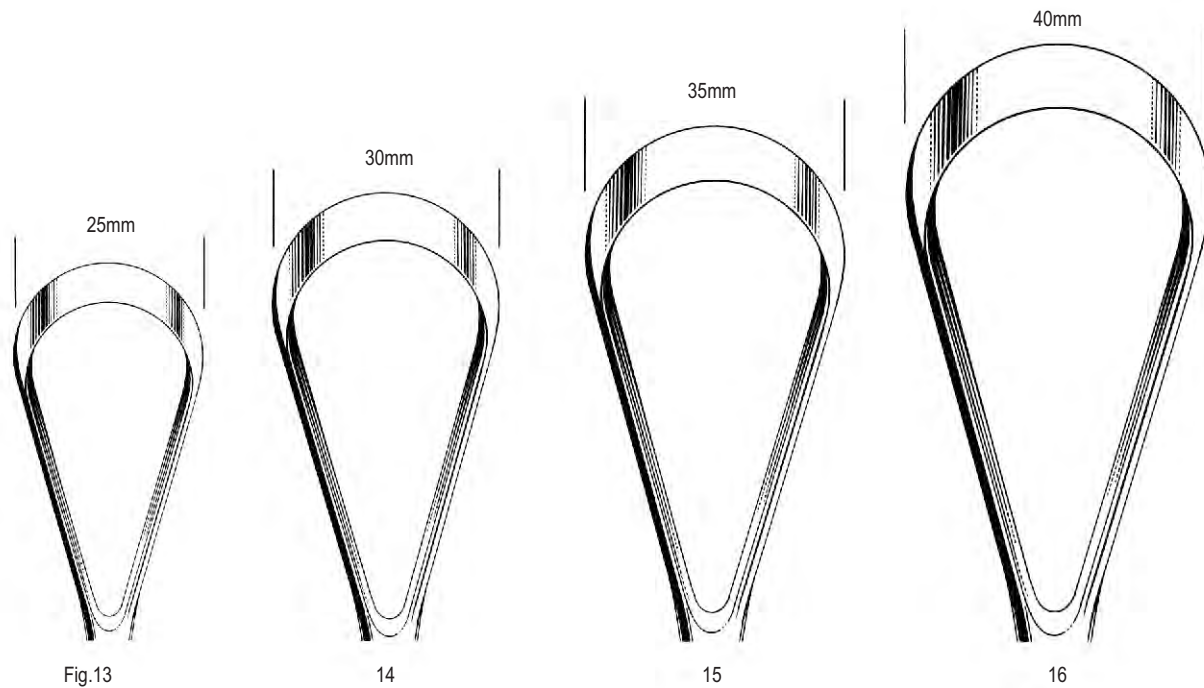
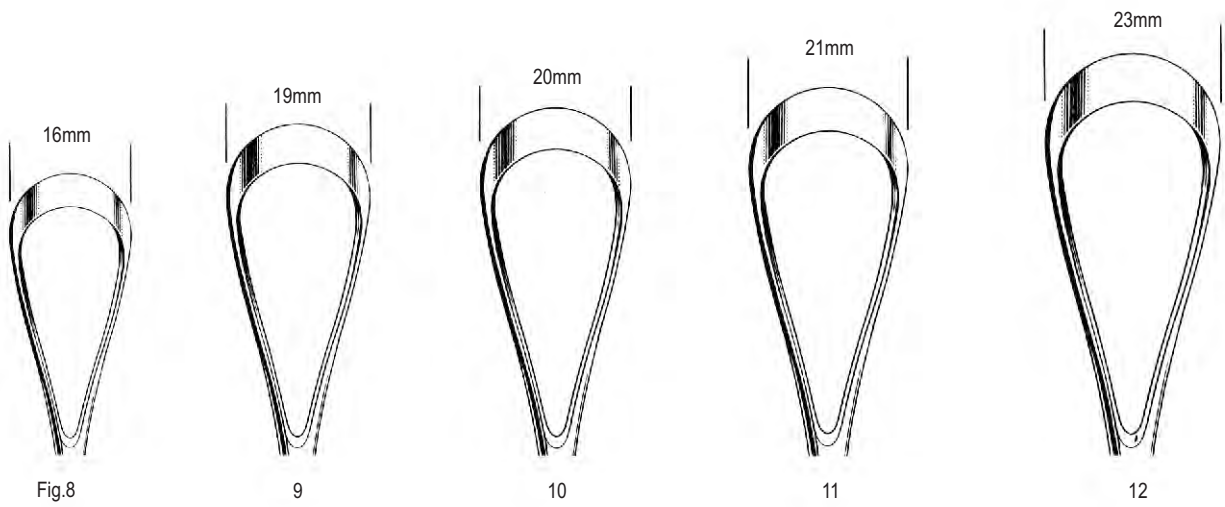
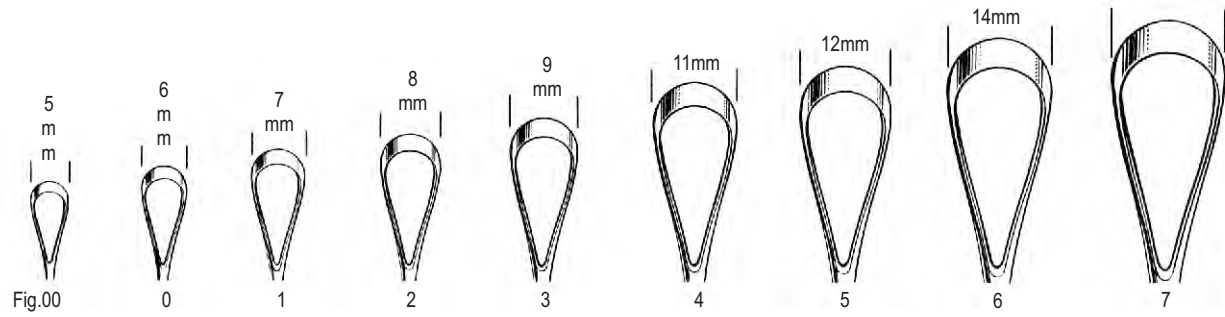
SIMS
31.0cm



RECAMIER
31.0cm

Fig	sharp	blunt	sharp	blunt
00	Ai 29-8225-05	Ai 29-8226-05	Ai 29-8227-05	Ai 29-8228-05
0	Ai 29-8225-06	Ai 29-8226-06	Ai 29-8227-06	Ai 29-8228-06
1	Ai 29-8225-07	Ai 29-8226-07	Ai 29-8227-07	Ai 29-8228-07
2	Ai 29-8225-08	Ai 29-8226-08	Ai 29-8227-08	Ai 29-8228-08
3	Ai 29-8225-09	Ai 29-8226-09	Ai 29-8227-09	Ai 29-8228-09
4	Ai 29-8225-11	Ai 29-8226-11	Ai 29-8227-11	Ai 29-8228-11
5	Ai 29-8225-12	Ai 29-8226-12	Ai 29-8227-12	Ai 29-8228-12
6	Ai 29-8225-14	Ai 29-8226-14	Ai 29-8227-14	Ai 29-8228-14
7	Ai 29-8225-15	Ai 29-8226-15	Ai 29-8227-15	Ai 29-8228-15
8	Ai 29-8225-16	Ai 29-8226-16	Ai 29-8227-16	Ai 29-8228-16
9	Ai 29-8225-19	Ai 29-8226-19	Ai 29-8227-19	Ai 29-8228-19
10	Ai 29-8225-20	Ai 29-8226-20	Ai 29-8227-20	Ai 29-8228-20
11	Ai 29-8225-21	Ai 29-8226-21	Ai 29-8227-21	Ai 29-8228-21
12	Ai 29-8225-23	Ai 29-8226-23	Ai 29-8227-23	Ai 29-8228-23
13	Ai 29-8225-25	Ai 29-8226-25	Ai 29-8227-25	Ai 29-8228-25
14	Ai 29-8225-30	Ai 29-8226-30	Ai 29-8227-30	Ai 29-8228-30
15	Ai 29-8225-35	Ai 29-8226-35	Ai 29-8227-35	Ai 29-8228-35
16	Ai 29-8225-40	Ai 29-8226-40	Ai 29-8227-40	Ai 29-8228-40

Fig	sharp	blunt	sharp	blunt
00	Ai 29-8229-05	Ai 29-8230-05	Ai 29-8231-05	Ai 29-8232-05
0	Ai 29-8229-06	Ai 29-8230-06	Ai 29-8231-06	Ai 29-8232-06
1	Ai 29-8229-07	Ai 29-8230-07	Ai 29-8231-07	Ai 29-8232-07
2	Ai 29-8229-08	Ai 29-8230-08	Ai 29-8231-08	Ai 29-8232-08
3	Ai 29-8229-09	Ai 29-8230-09	Ai 29-8231-09	Ai 29-8232-09
4	Ai 29-8229-11	Ai 29-8230-11	Ai 29-8231-11	Ai 29-8232-11
5	Ai 29-8229-12	Ai 29-8230-12	Ai 29-8231-12	Ai 29-8232-12
6	Ai 29-8229-14	Ai 29-8230-14	Ai 29-8231-14	Ai 29-8232-14
7	Ai 29-8229-15	Ai 29-8230-15	Ai 29-8231-15	Ai 29-8232-15
8	Ai 29-8229-16	Ai 29-8230-16	Ai 29-8231-16	Ai 29-8232-16
9	Ai 29-8229-19	Ai 29-8230-19	Ai 29-8231-19	Ai 29-8232-19
10	Ai 29-8229-20	Ai 29-8230-20	Ai 29-8231-20	Ai 29-8232-20
11	Ai 29-8229-21	Ai 29-8230-21	Ai 29-8231-21	Ai 29-8232-21
12	Ai 29-8229-23	Ai 29-8230-23	Ai 29-8231-23	Ai 29-8232-23
13	Ai 29-8229-25	Ai 29-8230-25	Ai 29-8231-25	Ai 29-8232-25
14	Ai 29-8229-30	Ai 29-8230-30	Ai 29-8231-30	Ai 29-8232-30
15	Ai 29-8229-35	Ai 29-8230-35	Ai 29-8231-35	Ai 29-8232-35
16	Ai 29-8229-40	Ai 29-8230-40	Ai 29-8231-40	Ai 29-8232-40





BUMM
34.0cm

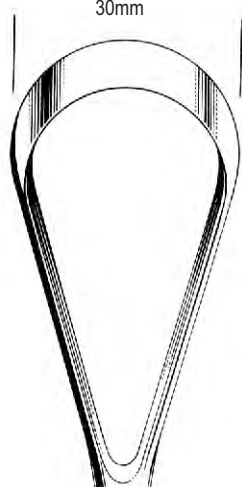
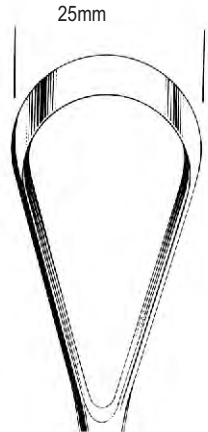
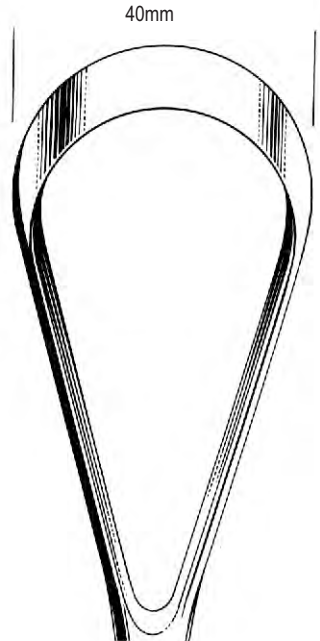
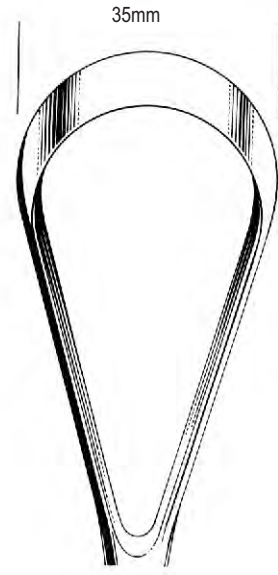


Fig. 13

14



15

16

Fig	sharp	blunt	sharp	blunt
13	Ai 29-8233-25	Ai 29-8234-25	Ai 29-8235-25	Ai 29-8236-25
14	Ai 29-8233-30	Ai 29-8234-30	Ai 29-8235-30	Ai 29-8236-30
15	Ai 29-8233-35	Ai 29-8234-35	Ai 29-8235-35	Ai 29-8236-35
16	Ai 29-8233-40	Ai 29-8234-40	Ai 29-8235-40	Ai 29-8236-40

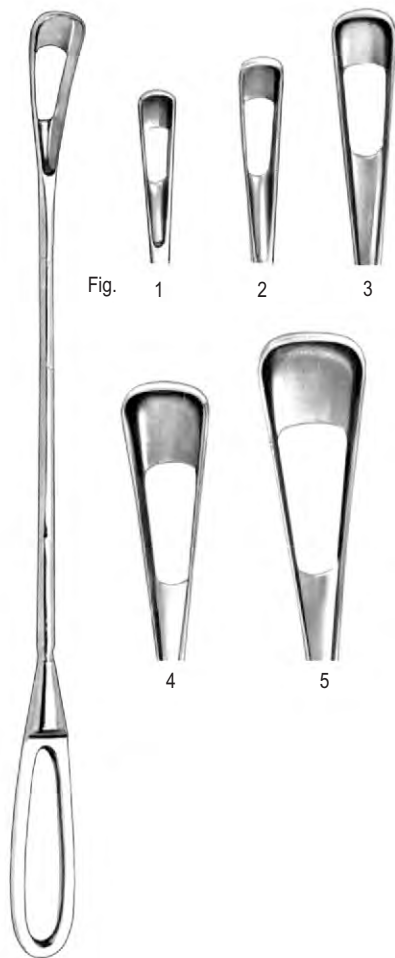


Fig. 1 2 3



4 5

28.0cm

Fig.		mm
1	Ai 29-8237-01	4.5
2	Ai 29-8237-02	6
3	Ai 29-8237-03	9
4	Ai 29-8237-04	12
5	Ai 29-8237-05	15

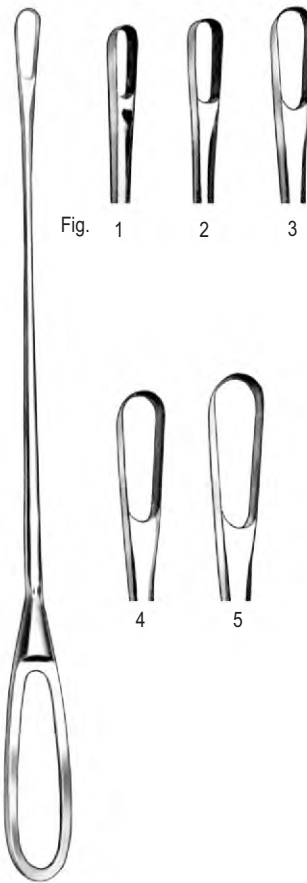


Fig. 1 2 3



4 5

OLSHAUSEN'S
27.0cm

Fig.	
1	Ai 29-8238-01
2	Ai 29-8238-02
3	Ai 29-8238-03
4	Ai 29-8238-04
5	Ai 29-8238-05

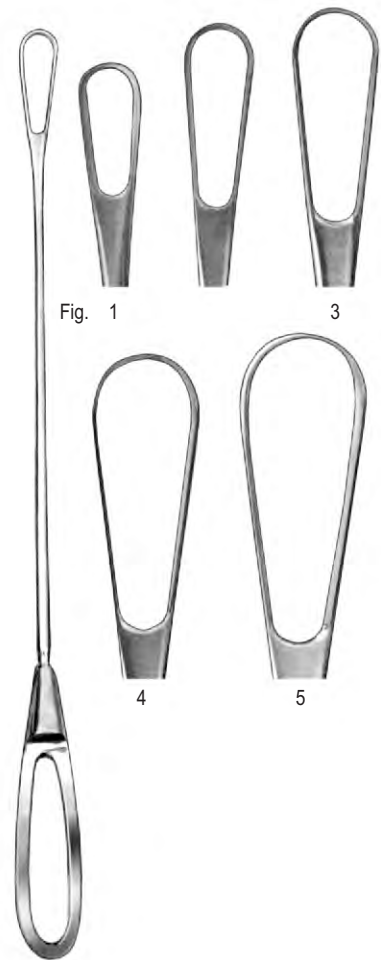


Fig. 1 3



4 5

BUMM'S
28.0cm

Fig.	
1	Ai 29-8239-01
2	Ai 29-8239-02
3	Ai 29-8239-03
4	Ai 29-8239-04
5	Ai 29-8239-05



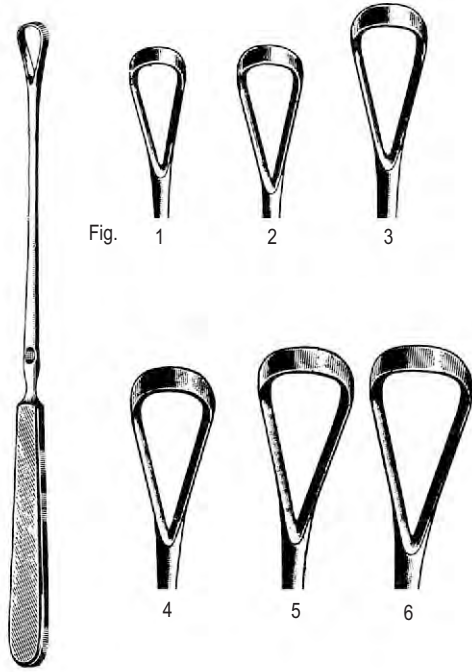


Fig.

1

2

3

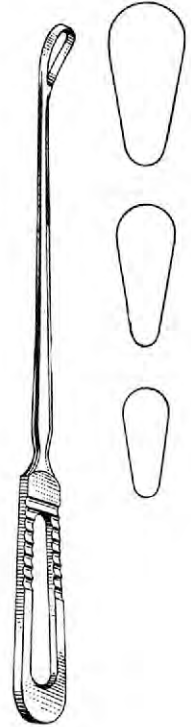
4

5

6

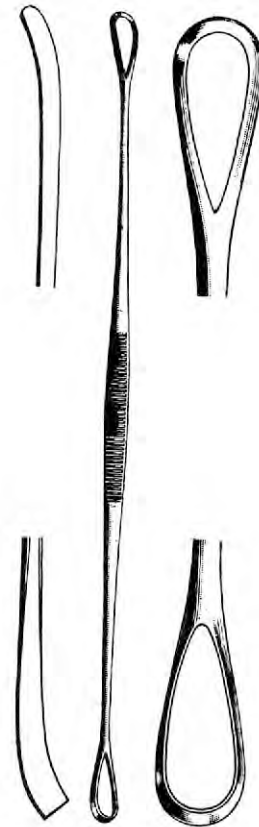
SIMS
25.0cm

	sharp	Fig	blunt
Ai 29-8240-01	1	Ai 29-8241-01	
Ai 29-8240-02	2	Ai 29-8241-02	
Ai 29-8240-03	3	Ai 29-8241-03	
Ai 29-8240-04	4	Ai 29-8241-04	
Ai 29-8240-05	5	Ai 29-8241-05	
Ai 29-8240-06	6	Ai 29-8241-06	

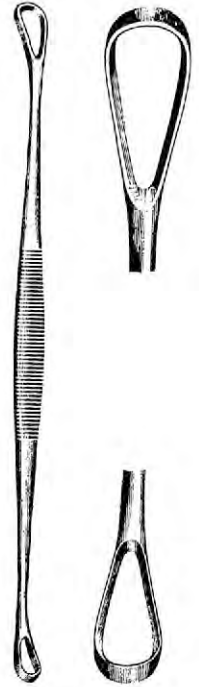


SIMS
25.0cm

	sharp	Fig	blunt
Ai 29-8242-01	1	Ai 29-8243-01	
Ai 29-8242-02	2	Ai 29-8243-02	
Ai 29-8242-03	3	Ai 29-8243-03	



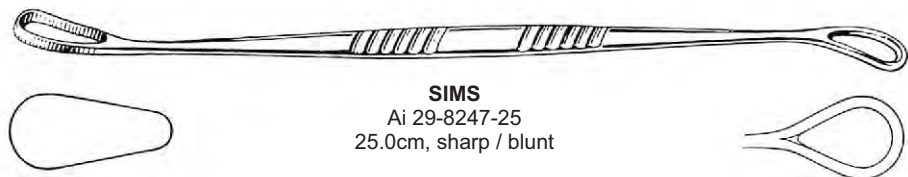
sharp / blunt
Ai 29-8244-27 27.0cm



BLAKE
sharp / blunt
Ai 29-8245-27 27.0cm



SIMS
Ai 29-8246-25
25.0cm, sharp



SIMS
Ai 29-8247-25
25.0cm, sharp / blunt



Fig.1

UNIVERSAL
28.0cm

- Fig
 1 Ai 29-8248-01
 2 Ai 29-8248-02
 3 Ai 29-8248-03

RHEINSTADTER
29.0cm

- | | |
|-----------------------|---------------|
| sharp | blunt |
| Ai 29-8249-01 7.9 mm | Ai 29-8250-01 |
| Ai 29-8249-02 11.1 mm | Ai 29-8250-02 |
| Ai 29-8249-03 14.3mm | Ai 29-8250-03 |

CHELSEA HOSPITAL
Ai 29-8251-31 31.0cm

DONALD
sharp
Ai 29-8252-33 33.0cm



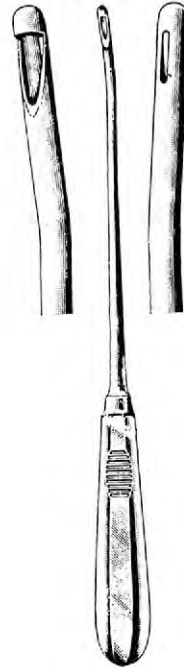
RANDALL
24.0cm
1mm dia. Ai 29-8253-01
2mm dia. Ai 29-8253-02
3mm dia. Ai 29-8253-03
4mm dia. Ai 29-8253-04



NOVAK
23.0cm
Ai 29-8254-01
Ai 29-8254-02
Ai 29-8254-03
Ai 29-8254-04



SHERMAN
Ai 29-8255-23 23.0cm
3.5mm dia.



MUENCHEN
Ai 29-8256-27 27.0cm

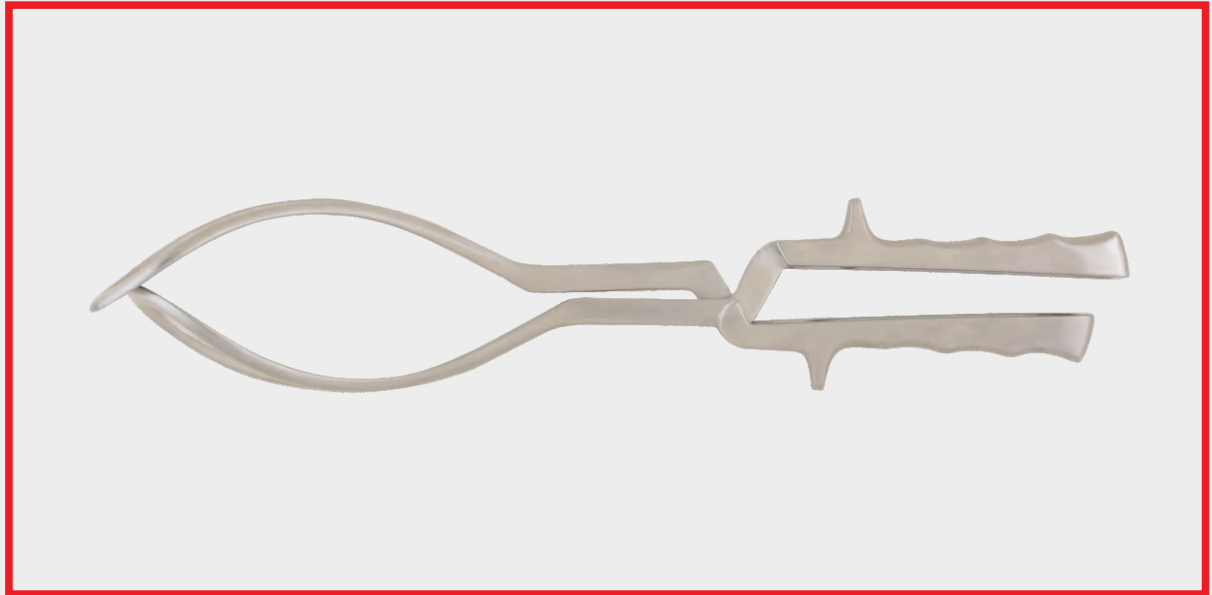


with basket

KEVORKIAN
30.0cm
Ai 29-8257-12 1.2mm Ai 29-8258-12
Ai 29-8257-40 4.0mm Ai 29-8258-40

- EN** Obstetrics
- DE** Geburtshilfe
- ES** Obstetricia

Page 723 to 740

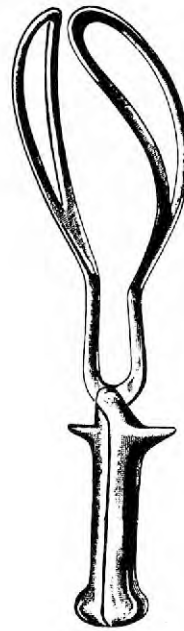




WRIGLEY
Ai 30-8401-23 23.0cm
Ai 30-8401-28 28.0cm



DE-LEE
Ai 30-8402-30 30.0cm



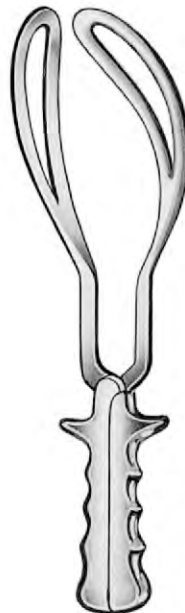
DE-LEE
Ai 30-8403-36 36.0cm



SIMPSON
Ai 30-8404-23 23.0cm, str.
Ai 30-8405-23 23.0cm, cvd.



SIMPSON
Ai 30-8406-23 23.0cm
Ai 30-8406-30 30.0cm



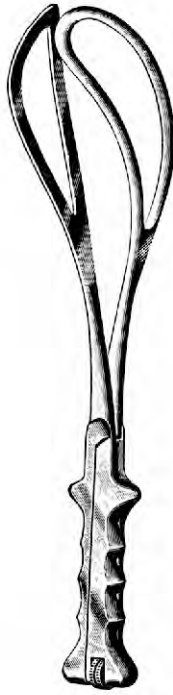
SIMPSON-BRAUN
Ai 30-8407-33 33.0cm
Ai 30-8407-36 36.0cm



KIELLAND
Ai 30-8408-41 41.0cm

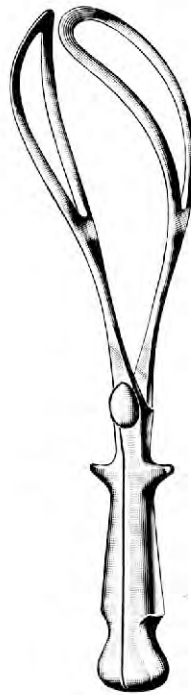


PIPER
Ai 30-8409-44 44.0cm



ELLIOT

Ai 30-8410-32 32.0cm
Ai 30-8410-38 38.0cm



NAEGELE

Ai 30-8411-36 36.0cm
Ai 30-8411-40 40.0cm



KEDAR NATH DAS

Ai 30-8412-33
33.0cm



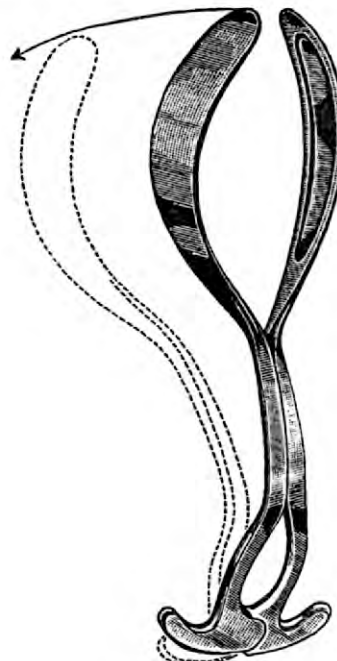
BOERMA

Ai 30-8413-29
29.0cm



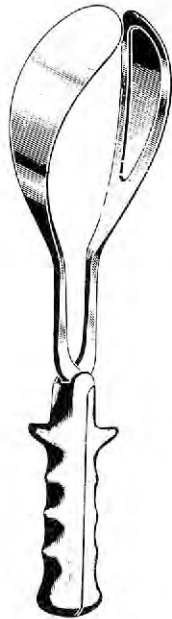
LAUFE-PIPER

Ai 30-8414-30
30.0cm

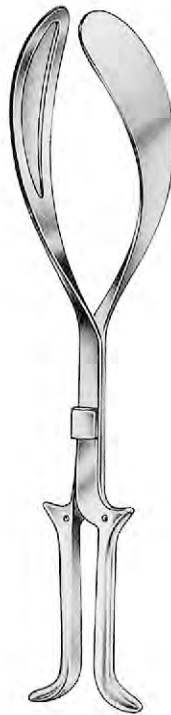


LAUFE DIVERGENT OUTLET

Ai 30-8415-31
31.0cm



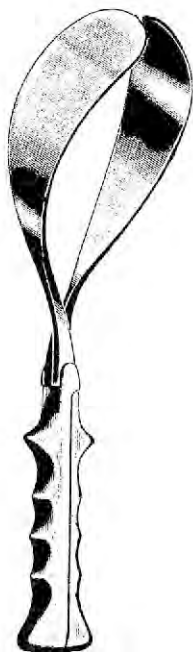
SIMPSON-LUIKART
 Ai 30-8416-36
 36.0cm



KIELLAND-LUIKART
 Ai 30-8417-40
 40.0cm



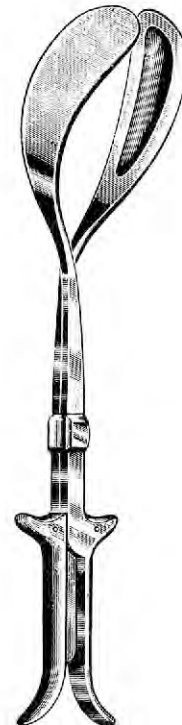
LUIKART
 Ai 30-8418-40
 40.0cm



McLEAN
 Ai 30-8419-36
 36.0cm



McLEAN-TUCKER
 Ai 30-8420-39
 39.0cm



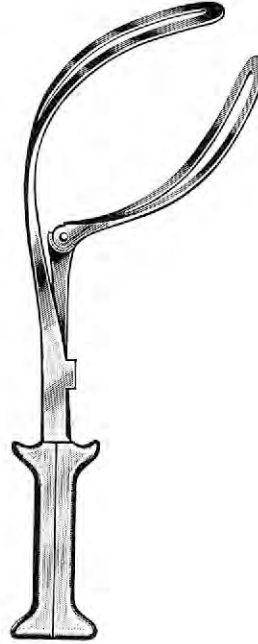
McLEAN-TUCKER-LUIKART
 Ai 30-8421-40
 40.0cm



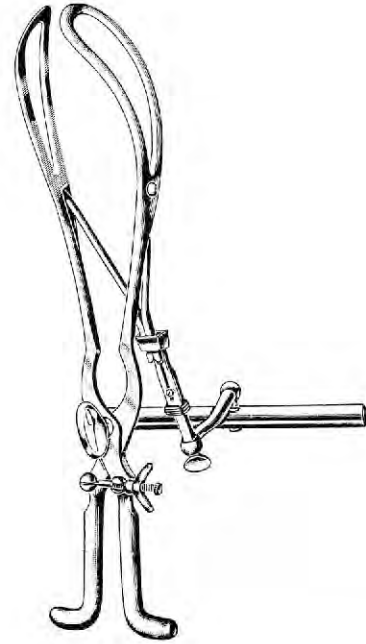
HIRST
 Ai 30-8422-26
 26.0cm



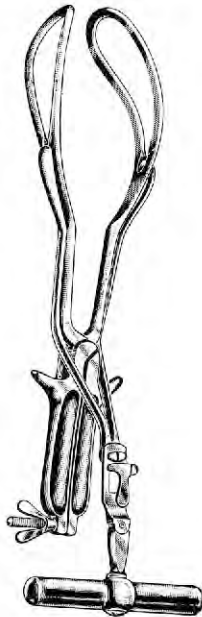
ANDERSON
 Ai 30-8423-38
 38.0cm



BARTON
 Ai 30-8424-36
 36.0cm



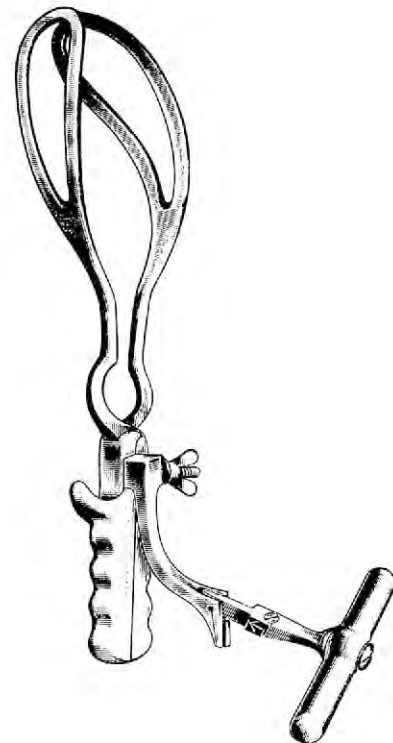
TARNIER
 Ai 30-8425-40
 40.0cm



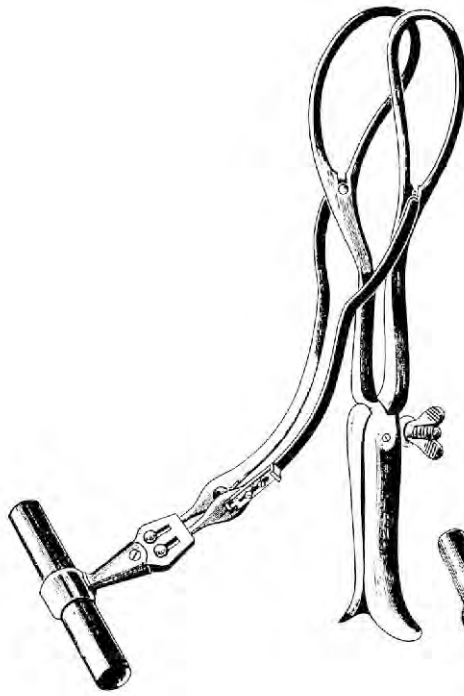
KEDAR NATH DAS
 Ai 30-8426-38
 38.0cm



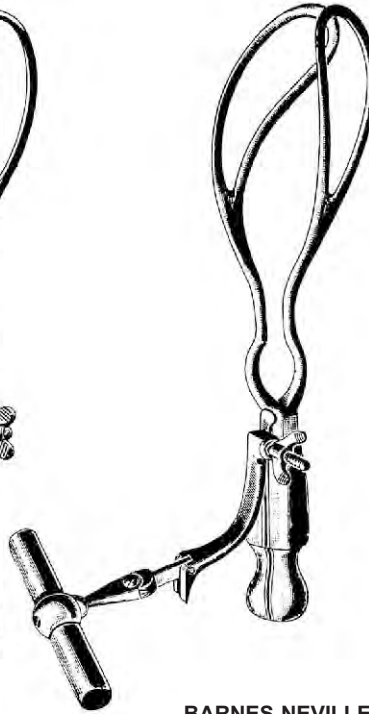
DEWEY
 Ai 30-8427-37
 37.0cm



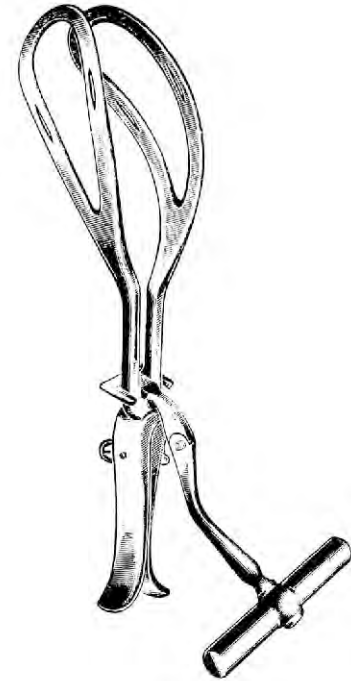
BARNES-NEVILLE-SIMPSON
 Ai 30-8428-40
 40.0cm



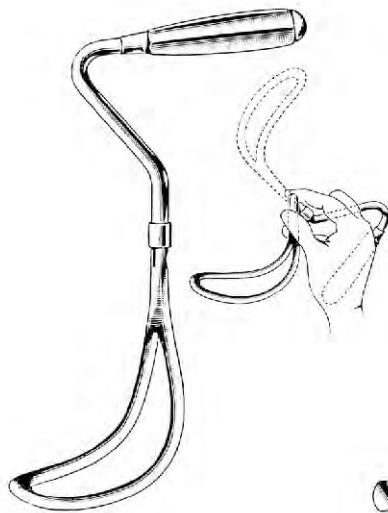
MILNE-MURRAY
 Ai 30-8429-40
 40.0cm



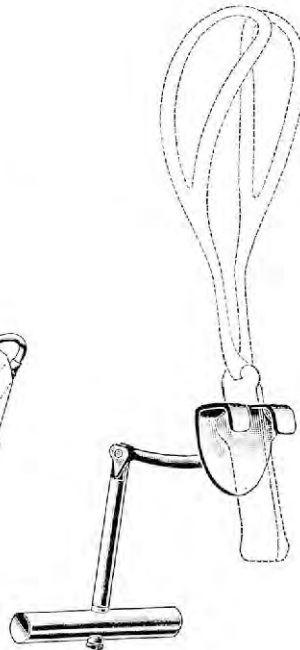
BARNES-NEVILLE
 Ai 30-8430-40
 40.0cm



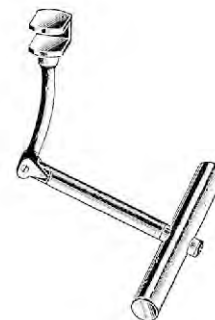
HAIG-FERGUSON
 Ai 30-8431-40
 40.0cm



MURLESS
 Ai 30-8432-26
 26.0cm



BILL
 Ai 30-8433-21
 21.0cm



LUIKART-BILL
 Ai 30-8434-21
 21.0cm



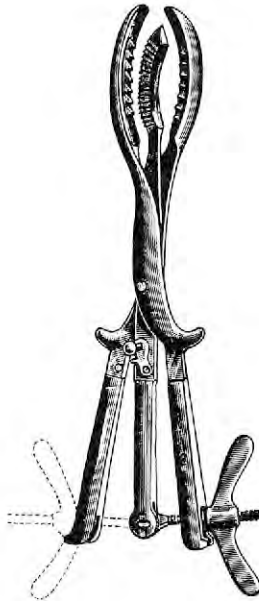
BARTON
 Ai 30-8435-17
 17.0cm



SMELLIE
 Ai 30-8436-25
 25.0cm



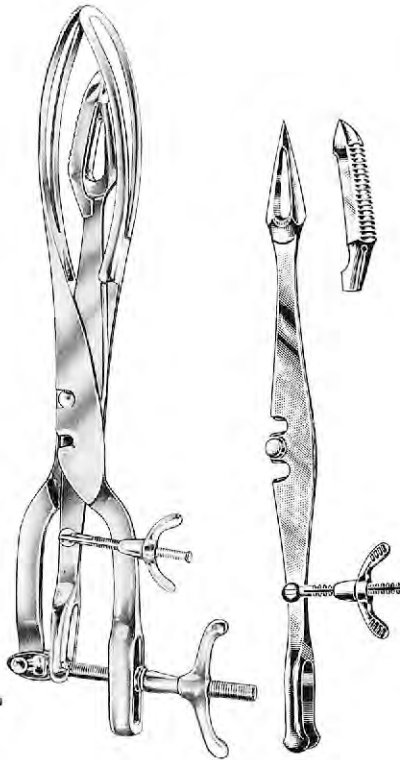
NAEGELE
 Ai 30-8437-25
 25.0cm



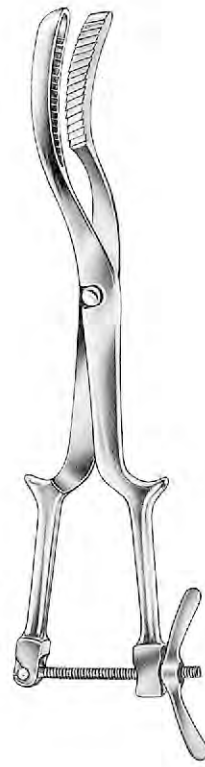
WINTER
 Ai 30-8438-36
 36.0cm



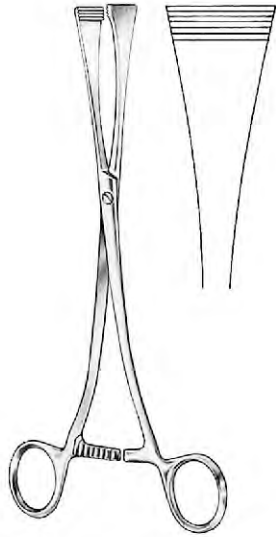
AUWARD-ZWEIFEL
 Ai 30-8439-42
 42.0cm



TARNIER
 Ai 30-8440-46
 46.0cm



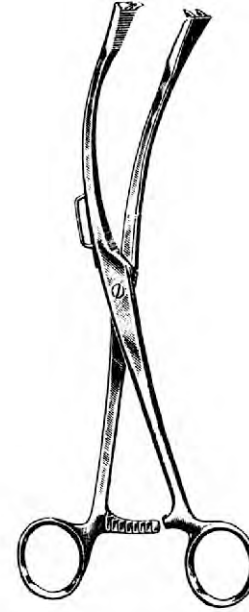
BRAUN
 Ai 30-8441-42
 42.0cm



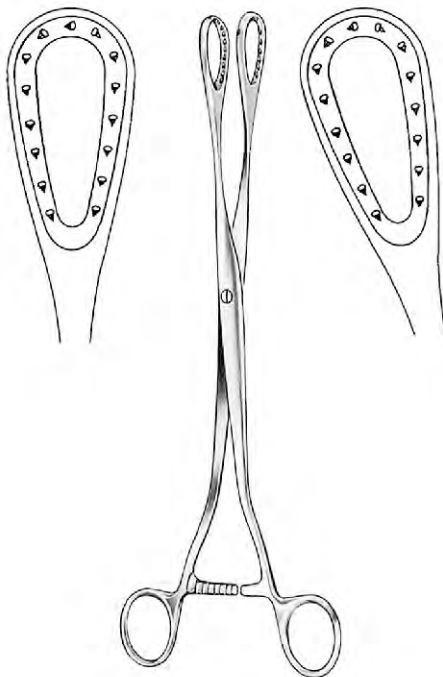
GREEN-ARMYTAGE
 Ai 30-8442-21
 21.0cm



GREEN-ARMYTAGE
 Ai 30-8443-19
 19.5cm



GAUSS
 Ai 30-8444-26
 26.0cm



SAENGER
 Ai 30-8445-27 27.0cm Ai 30-8446-27



SELLHEIM
 Ai 30-8447-28
 28.0cm



KANE
 Ai 30-8448-08
 8.5cm



COLLIN
 Ai 30-8449-09
 9.0cm



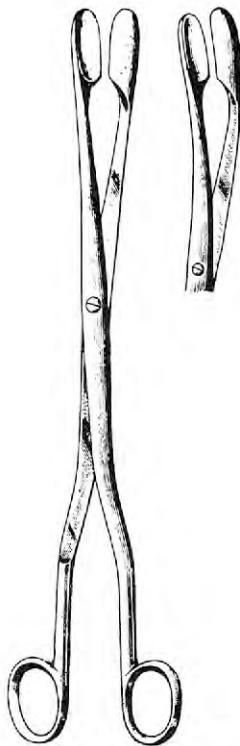
HEYWOOD-SMITH
 Ai 30-8450-25
 25.0cm



COREY
 Ai 30-8451-24
 24.0cm



WILLET
 Ai 30-8452-19
 19.0cm



WINTER
 28.0cm

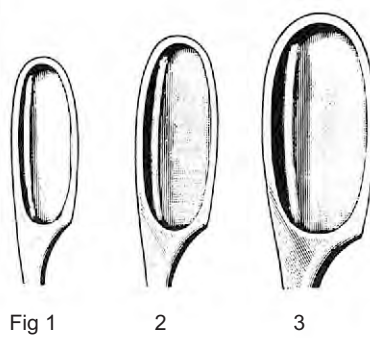
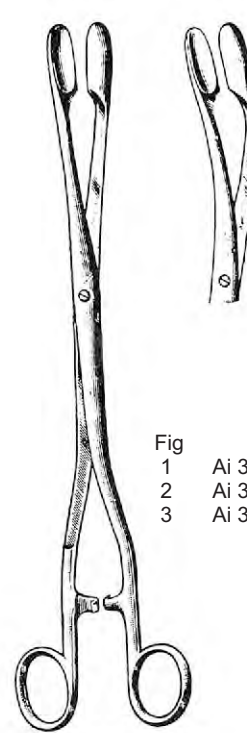
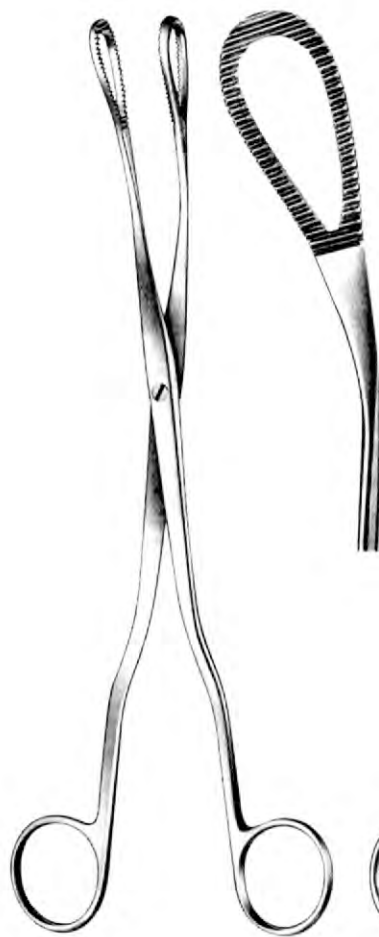


Fig	str	cur
1	Ai 30-8453-01	Ai 30-8454-01
2	Ai 30-8453-02	Ai 30-8454-02
3	Ai 30-8453-03	Ai 30-8454-03

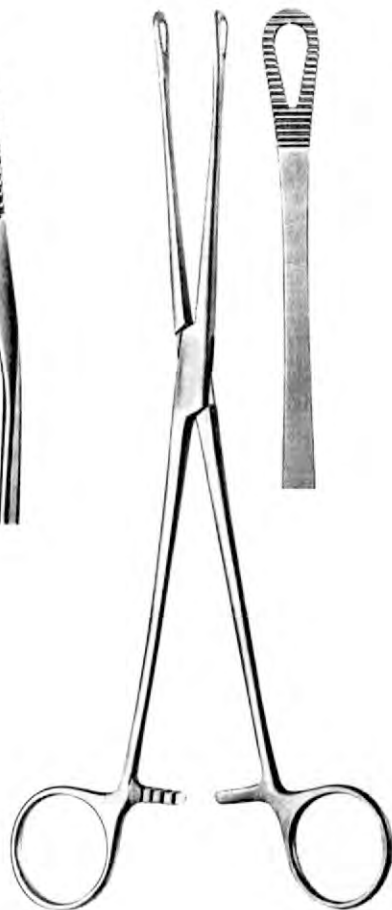


WINTER-NASSAUER
 28.0cm

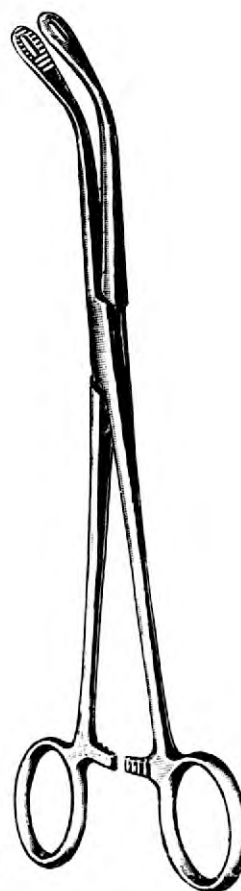
Fig	str	cur
1	Ai 30-8455-01	Ai 30-8456-01
2	Ai 30-8455-02	Ai 30-8456-02
3	Ai 30-8455-03	Ai 30-8456-03



Mc CLINTOCK
 Ai 30-8457-24
 24.0cm



BONNEY
 Ai 30-8458-24
 24.0cm

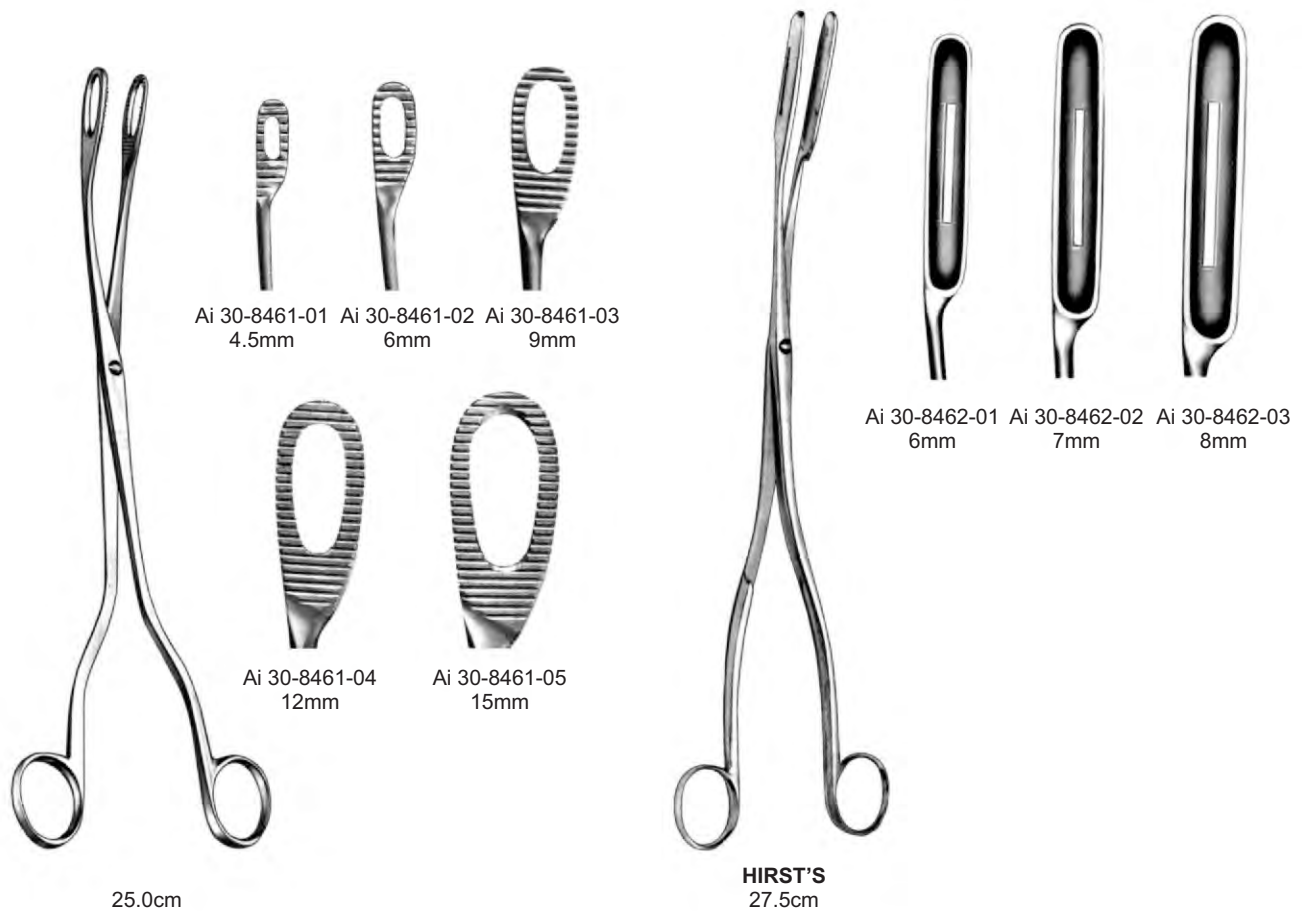


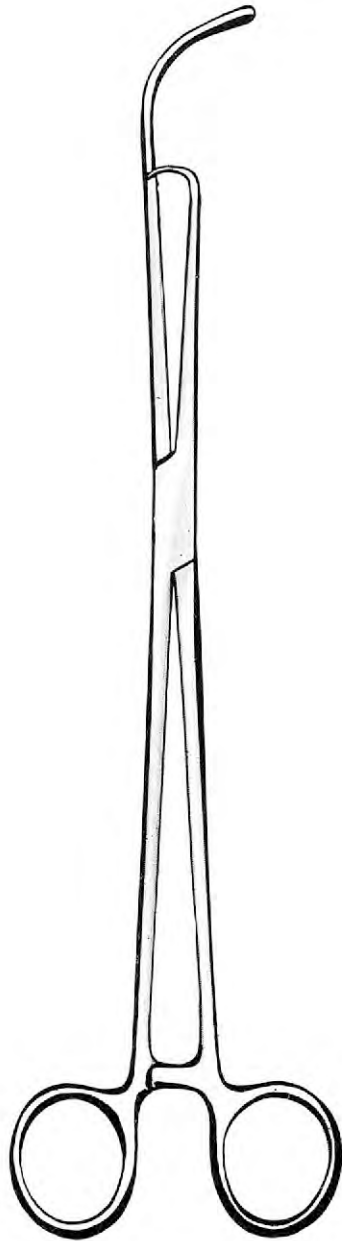
VANT'S
 Ai 30-8459-24 24.0cm
 Ai 30-8459-27 27.0cm



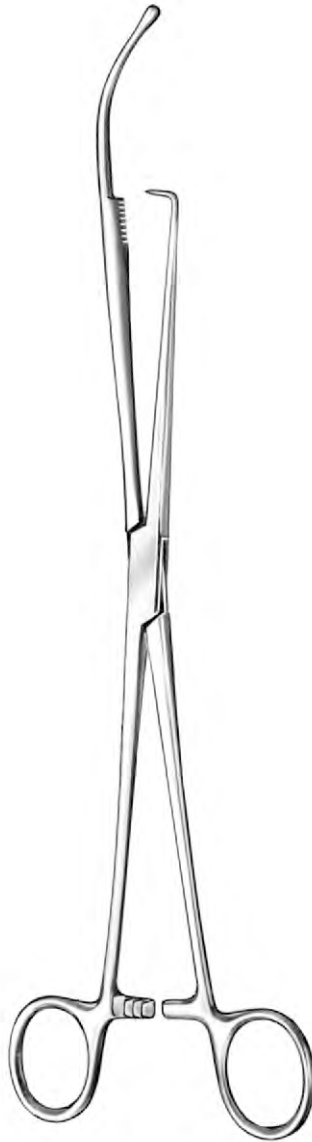
BIERER
 Ai 30-8460-28
 28.0cm



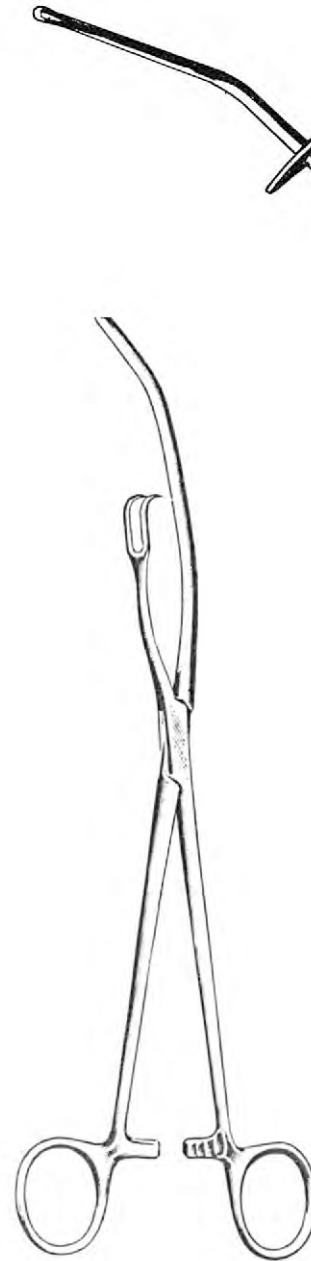




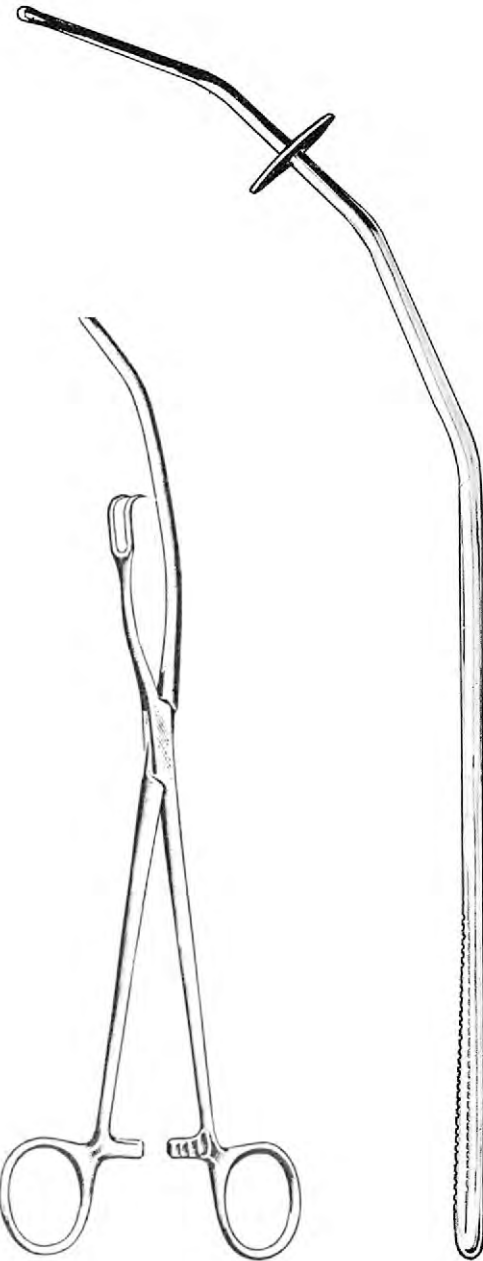
HULKA
Ai 30-8463-00



HULKA
Ai 30-8464-30
30.0cm



HULKA-KENWICK
Ai 30-8465-27
27.5cm



RAMATHIBODI
Ai 30-8466-00





CARTON
 Ai 30-8467-30
 30.0cm
 5mm Ø



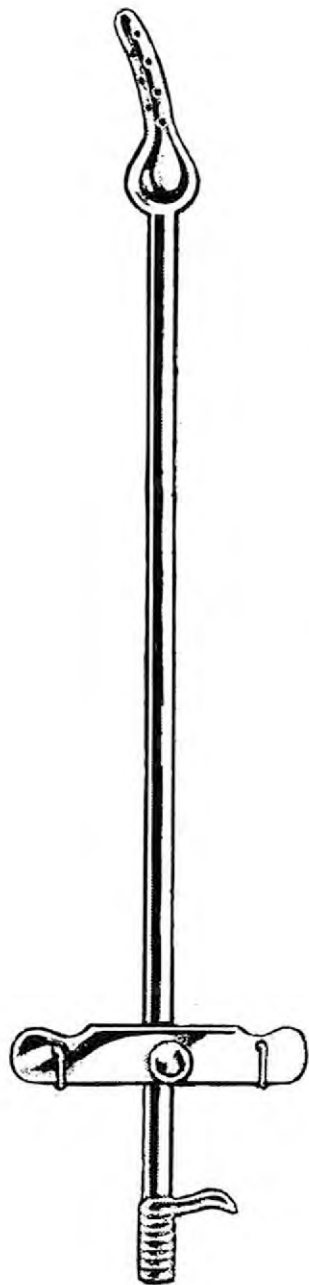
MARSHAL-COWELL
 Ai 30-8468-00



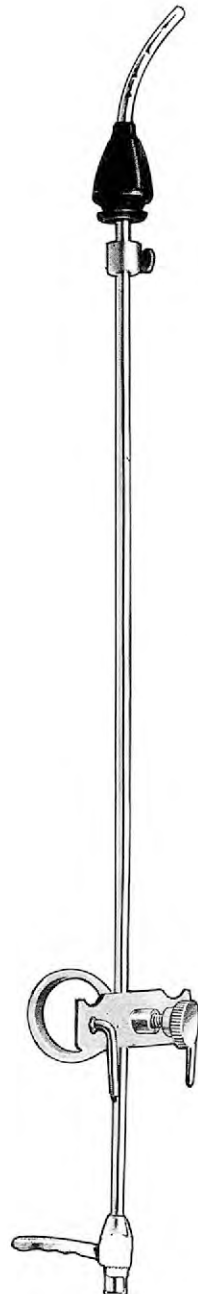
BOZEMANN-FRITSCH
 Ai 30-8469-08 8mm Ø
 Ai 30-8469-10 10mm Ø
 Ai 30-8469-12 12mm Ø



DREW-SMYTHE
 Ai 30-8470-33
 33.5cm



SPACKMANN
 Ai 30-8471-35 35.0cm



SPACKMANN
 Ai 30-8472-35 35.0cm



LEECH-WILKINSON
 26.5cm



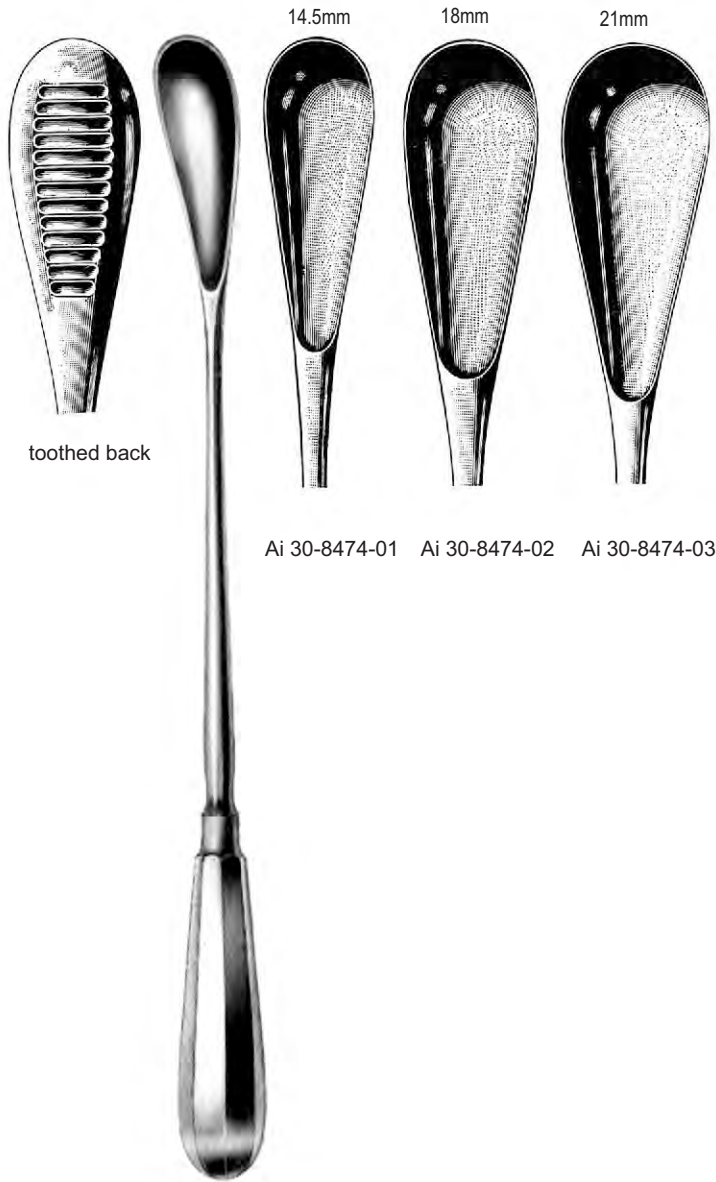
Ai 30-8473-01
 Ø 10 x 25mm
 small



Ai 30-8473-02
 Ø 13 x 30mm
 medium



Ai 30-8473-03
 Ø 16 x 30mm
 large



toothed back

14.5mm

18mm

21mm

Ai 30-8474-01

Ai 30-8474-02

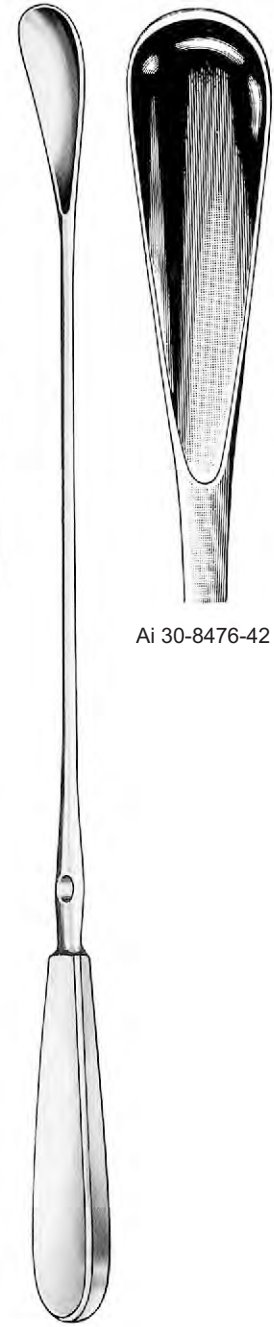
Ai 30-8474-03

CUZZI
30.0cm, blunt



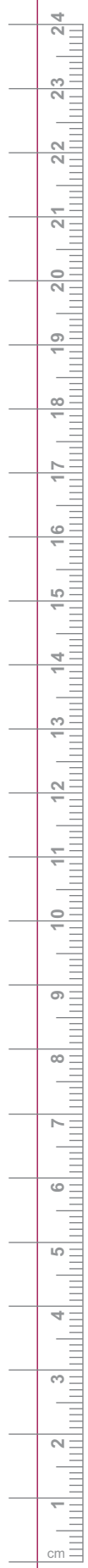
Ai 30-8475-30

PESTALOZZA
30.0cm



Ai 30-8476-42

WALLICH
42.0cm, blunt



Ai 30-8477-03
3 mm Ø

Ai 30-8478-04
4,5 mm Ø

Ai 30-8479-06
6 mm Ø

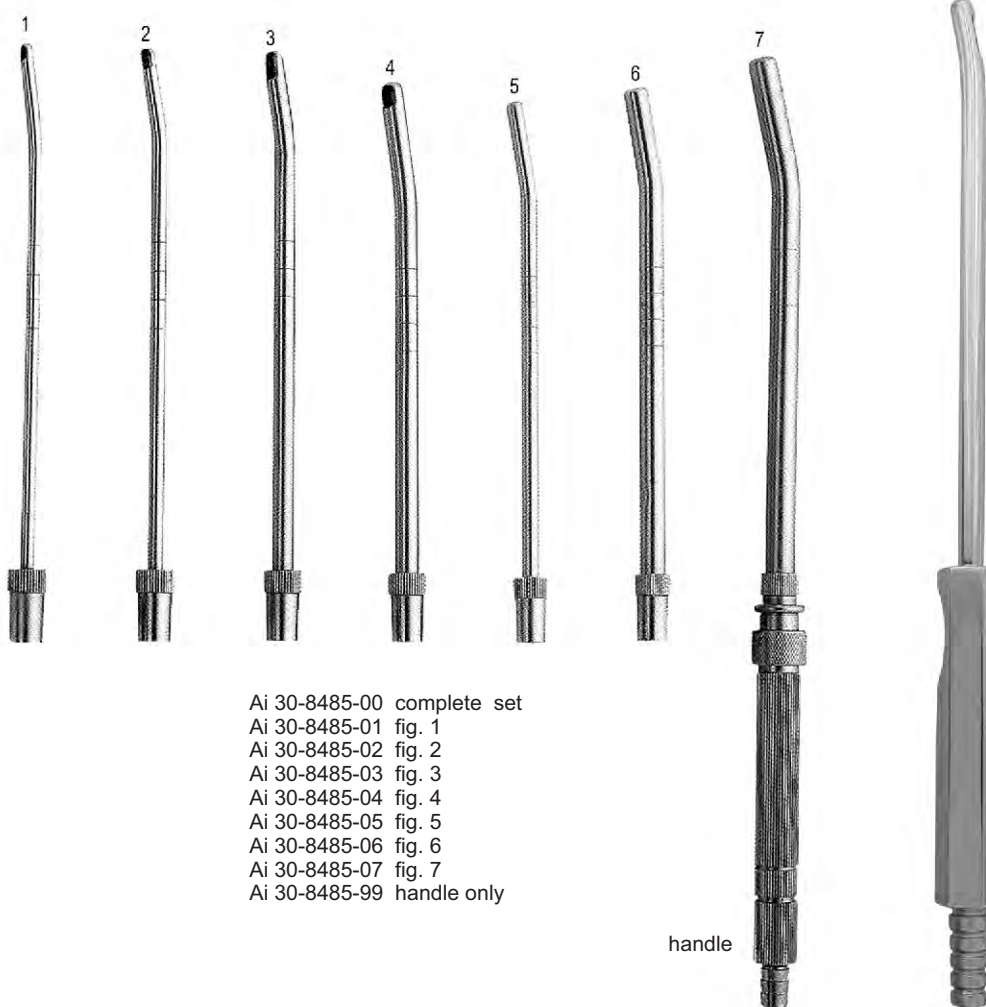
Ai 30-8480-08
8 mm Ø

Ai 30-8481-10
10 mm Ø

Ai 30-8482-12
12 mm Ø

Ai 30-8483-14
14 mm Ø

Ai 30-8484-50



Ai 30-8485-00 complete set
 Ai 30-8485-01 fig. 1
 Ai 30-8485-02 fig. 2
 Ai 30-8485-03 fig. 3
 Ai 30-8485-04 fig. 4
 Ai 30-8485-05 fig. 5
 Ai 30-8485-06 fig. 6
 Ai 30-8485-07 fig. 7
 Ai 30-8485-99 handle only

handle

32.0cm
 Ai 30-8486-08 8mm
 Ai 30-8486-10 10mm
 Ai 30-8486-12 12mm



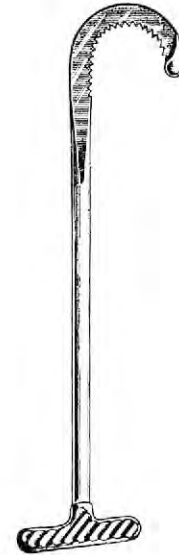
SMELLIE
 Ai 30-8487-33
 33.0cm



BRAUN
 Ai 30-8488-30
 30.0cm



Ai 30-8489-26
 26.0cm



TARGETT
 Ai 30-8490-30
 30.0cm



RAMATHIBODI
 Ai 30-8491-00



IUD
 Ai 30-8492-00



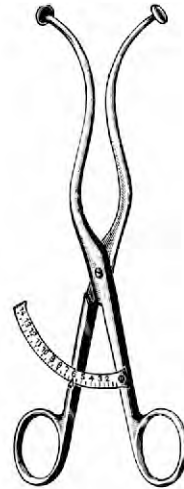
Ai 30-8493-00



IUD
 Ai 30-8494-00



COLLYER
 Ai 30-8495-33 33.0cm
 cm / inch scale



DELEE
 Ai 30-8496-20 20.0cm
 cm / inch scale



MARTIN
 Ai 30-8497-34 34.0cm
 Ai 30-8498-34 34.0cm
 cm / inch scale



COLLIN
 Ai 30-8499-35
 35.0cm
 cm scale



BREISKY
 Ai 30-8500-33
 33.0cm
 cm / inch scale

EN

Goitre

DE

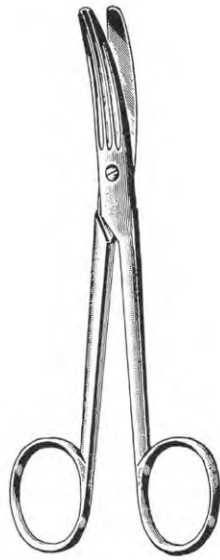
Kropfchirurgie

ES

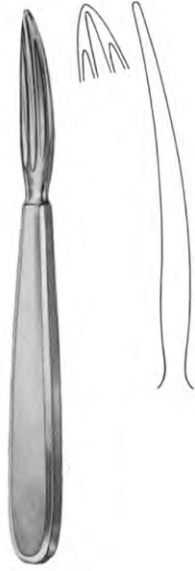
Bocio

Page 741

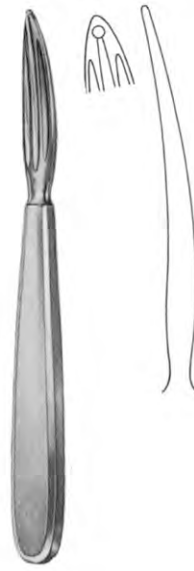




SCHOEMAKER
 Ai 31-8601-15
 15.0cm



KOCHER
 Ai 31-8602-15 15.0cm
 Ai 31-8602-16 16.0cm



KOCHER
 Ai 31-8603-15
 Ai 31-8603-16



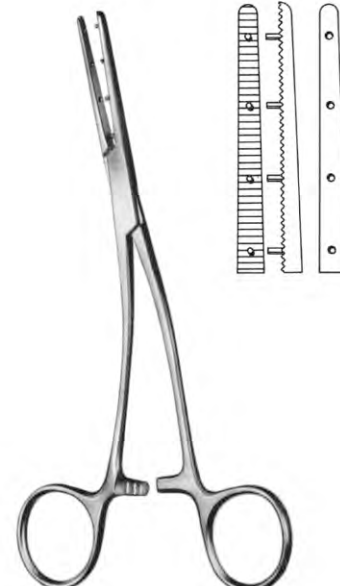
KOCHER
 Ai 31-8604-18
 18.0cm



HOFMEISTER
 Ai 31-8605-21
 21.0cm



LAHEY
 Ai 31-8606-15 15.0cm
 Ai 31-8606-20 20.0cm



MASTIN
 Ai 31-8607-17
 17.0cm



EN Sterilization

DE Sterilisation

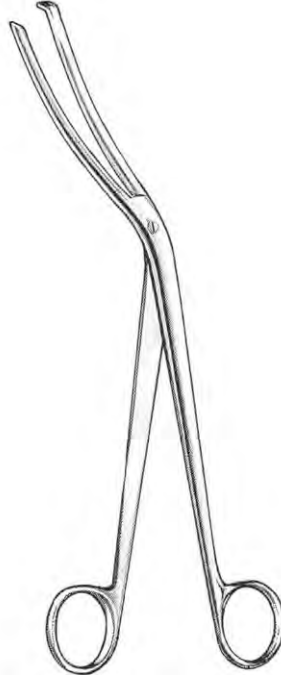
ES Esterilización

Page 742 to 743

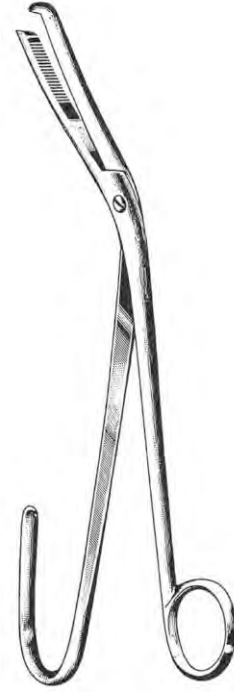




CHEATLE
 Ai 32-8701-27
 27.0cm



CHEATLE
 Ai 32-8702-26
 26.5cm



CHEATLE
 Ai 32-8703-28
 28.0cm



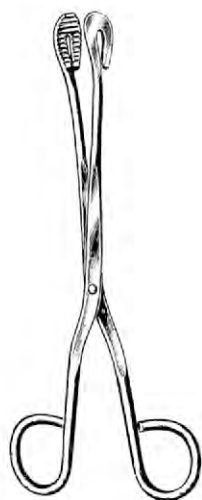
Ai 32-8704-20 20.0cm
 Ai 32-8704-30 30.0cm



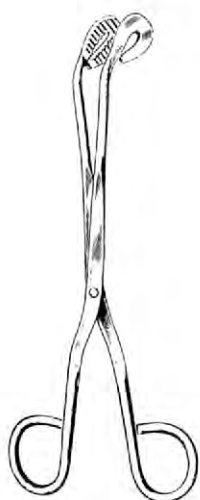
ROGGE
 Ai 32-8705-23
 23.0cm



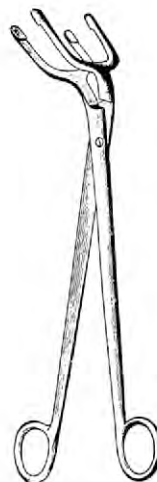
DAVIS
 Ai 32-8706-16 16.0cm
 Ai 32-8706-20 20.0cm
 Ai 32-8706-24 24.0cm



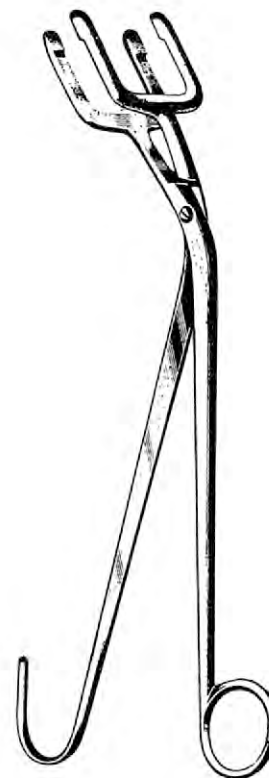
UNIVERSAL
 Ai 32-8707-20 20.0cm
 Ai 32-8707-28 28.0cm



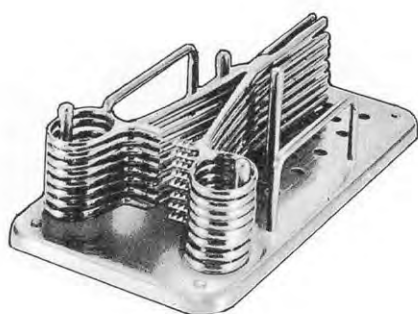
UNIVERSAL
 Ai 32-8708-20 20.0cm
 Ai 32-8708-28 28.0cm



PYE-SMITH (HARRISON)
 Ai 32-8709-25 25.0cm
 Ai 32-8709-30 30.0cm



HARRISON
 Ai 32-8710-25 25.0cm
 Ai 32-8710-30 30.0cm
 Ai 32-8710-35 35.0cm
 Ai 32-8710-45 45.0cm



Ai 32-8711-00



BUNT
 Ai 32-8712-12 12.0cm



MAYO
 Ai 32-8713-10 10.0cm
 Ai 32-8713-12 12.0cm
 Ai 32-8713-14 14.0cm
 Ai 32-8713-15 15.0cm



MAYO
 Ai 32-8714-14 14.0cm

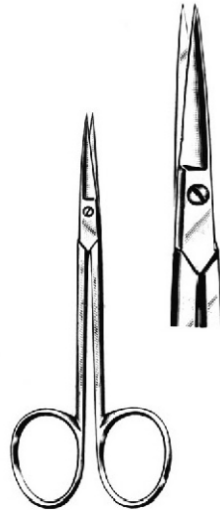
EN Asepsis

DE Asepsis

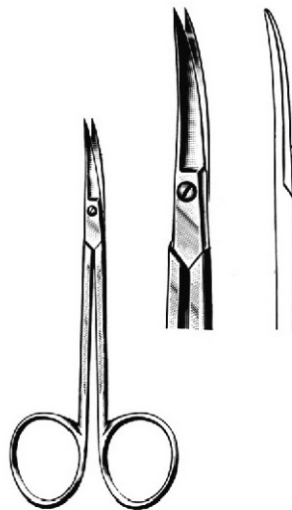
ES Asepsia

Page 744 to 745





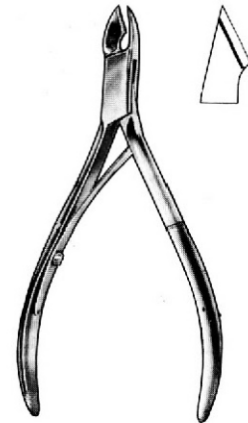
Ai 33-8801-10
10.5 cm/4"



Ai 33-8802-10
10.5 cm/4"



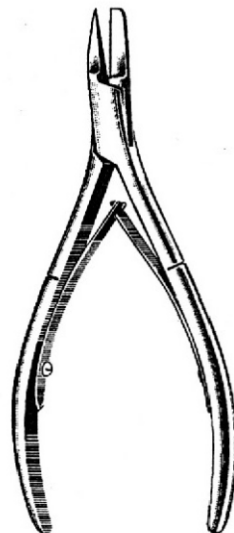
Ai 33-8803-10
10.5 cm/4"



Ai 33-8804-10 10.5 cm/4"
 Ai 33-8804-11 11.5 cm/4 1/2"
 Ai 33-8804-13 13 cm/5"



Ai 33-8805-10 10.5 cm/4"
 Ai 33-8805-11 11.5 cm/4 1/2"
 Ai 33-8805-13 13 cm/5"
 Ai 33-8805-15 15 cm/6"



INGROWN TOE NAIL FORCEPS
ENGLISH (ANVIL) PATTERN
 Ai 33-8806-12
 12.5 cm/5"



Ai 33-8807-10 10 cm/4"
 Ai 33-8807-12 12 cm/5"



Ai 33-8808-16
 16 cm/6 1/2"



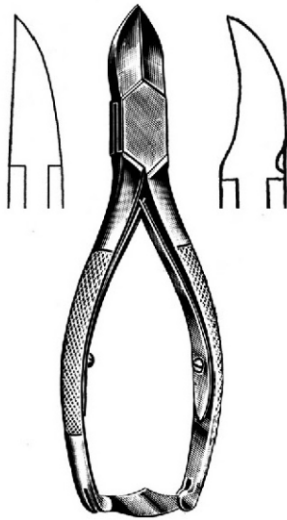
Ai 33-8809-09 9 cm/3 1/2" Ai 33-8810-09
 Ai 33-8809-10 10 cm/4" Ai 33-8810-10
 Ai 33-8809-11 11cm/4 1/2" Ai 33-8810-11



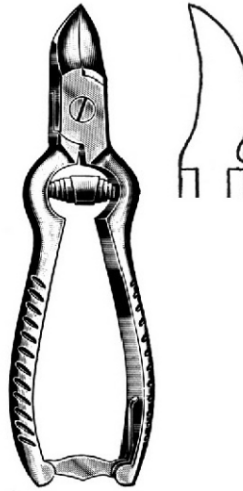
Ai 33-8811-12 12 cm/5"
 Ai 33-8811-13 13 cm/5 1/4"



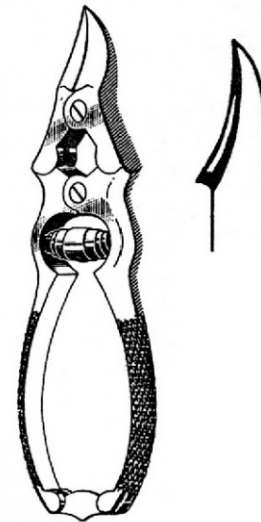
Ai 33-8812-14
 14 cm/5 1/2"



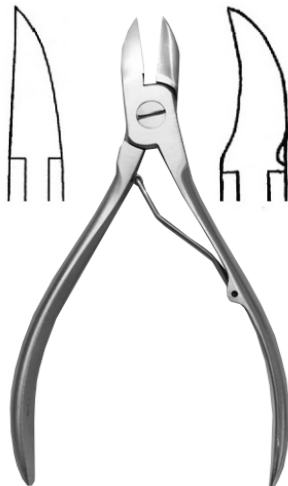
Ai 33-8814-14 14 cm/5 1/2"
 Ai 33-8814-16 16 cm/6 1/2"



TURNBULL
 Ai 33-8815-11 11 cm/4 1/2"
 Ai 33-8815-13 13 cm/5"



**NAIL NIPPER
 Double Action**
 Ai 33-8816-15
 15 cm/6"



Ai 33-8817-12 12 cm/5" Ai 33-8818-12
 Ai 33-8817-13 13 cm/5 1/2" Ai 33-8818-13



Ai 33-8819-15
 S/E



Ai 33-8820-15
 D/E



EN Hollowware

DE Hollowware

ES Hollowware

Page 746 to 753





Needle Case Round with Cover
Ai 34-8901-01 65x15mm



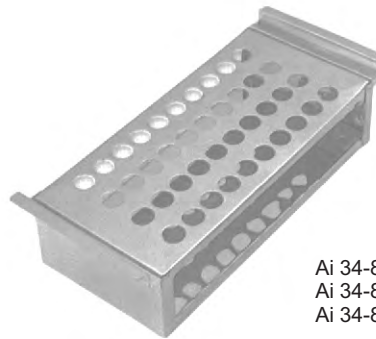
Needle Case Round
Ai 34-8902-01 80x20mm



Needle Case Rectangle
Ai 34-8903-01 70x70x10mm



Endodontic Box
Ai 34-8904-01
100x40x50mm



Tube Rack

Ai 34-8905-01 6.35x15.25x5cm for 12 tubes
Ai 34-8905-02 6.35x17.75x7.5cm for 27 tubes
Ai 34-8905-03 7.50x17.75x6.35cm for 36 tubes



Sprit Lamp
Ai 34-8906-01
Standard Size



Sprit Lamp
Ai 34-8907-01
Standard Size



Sputum Cup
Ai 34-8908-01 75x80mm
Ai 34-8908-02 100x50mm
Ai 34-8908-03 100x80mm



Dressing Jar

- | | | |
|---------------|-----------|---------------|
| Ai 34-8909-01 | 80x60mm | Ai 34-8910-01 |
| Ai 34-8909-02 | 80x80mm | Ai 34-8910-02 |
| Ai 34-8909-03 | 100x100mm | Ai 34-8910-03 |
| Ai 34-8909-04 | 120x120mm | Ai 34-8910-04 |
| Ai 34-8909-05 | 150x150mm | Ai 34-8910-05 |
| Ai 34-8909-06 | 180x180mm | Ai 34-8910-06 |
| Ai 34-8909-07 | 200x200mm | Ai 34-8910-07 |



Dressing Jar



Fennle

- | | |
|---------------|---------|
| Ai 34-8912-01 | 100mm Ø |
| Ai 34-8912-02 | 120mm Ø |
| Ai 34-8912-03 | 150mm Ø |
| Ai 34-8912-04 | 200mm Ø |



Cotton Holder
Ai 34-8911-01



Cotton Holder
Ai 34-8911-02



Forceps Jar

- | | |
|---------------|-----------|
| Ai 34-8913-01 | 30x90mm |
| Ai 34-8913-02 | 50x125mm |
| Ai 34-8913-03 | 50x170mm |
| Ai 34-8913-04 | 50x200mm |
| Ai 34-8913-05 | 40x230mm |
| Ai 34-8913-06 | 70x110mm |
| Ai 34-8913-07 | 80x150mm |
| Ai 34-8913-08 | 100x200mm |
| Ai 34-8913-09 | 150x30mm |



Gallipot

- | | | | |
|---------------|-------|---------------|-------|
| Ai 34-8914-01 | 01 oz | Ai 34-8914-09 | 09 oz |
| Ai 34-8914-02 | 02 oz | Ai 34-8914-10 | 10 oz |
| Ai 34-8914-03 | 03 oz | Ai 34-8914-11 | 11 oz |
| Ai 34-8914-04 | 04 oz | Ai 34-8914-12 | 12 oz |
| Ai 34-8914-05 | 05 oz | Ai 34-8914-13 | 13 oz |
| Ai 34-8914-06 | 06 oz | Ai 34-8914-14 | 14 oz |
| Ai 34-8914-07 | 07 oz | Ai 34-8914-15 | 15 oz |
| Ai 34-8914-08 | 08 oz | Ai 34-8914-16 | 16 oz |



Spong Bowl

- | | |
|---------------|-------|
| Ai 34-8915-01 | 12 cm |
| Ai 34-8915-02 | 15 cm |
| Ai 34-8915-03 | 20 cm |





Medicine Cup

- Ai 34-8916-01 50ml
- Ai 34-8916-02 60ml
- Ai 34-8916-03 70ml



Lotion Bowl without spout

- | | |
|------------------------|-------------------------|
| Ai 34-8917-01 40x19mm | Ai 34-8917-08 150x65mm |
| Ai 34-8917-02 50x25mm | Ai 34-8917-09 180x85mm |
| Ai 34-8917-03 60x30mm | Ai 34-8917-10 200x100mm |
| Ai 34-8917-04 80x40mm | Ai 34-8917-11 250x120mm |
| Ai 34-8917-05 100x50mm | Ai 34-8917-12 300mm |
| Ai 34-8917-06 120x60mm | Ai 34-8917-13 350mm |
| Ai 34-8917-07 140x60mm | Ai 34-8917-14 400mm |



Wash Basin

- Ai 34-8918-01 300x80mm
- Ai 34-8918-02 320x85mm
- Ai 34-8918-03 330x90mm
- Ai 34-8918-04 350x110mm
- Ai 34-8918-05 400x115mm



Kick Bucket with Trolley

- Ai 34-8919-01
390x280x180mm



Kidney Tray Shallow

- Ai 34-8920-01 17cm
- Ai 34-8920-02 22cm
- Ai 34-8920-03 24cm



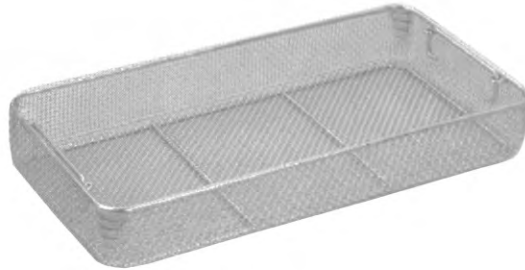
Kidney Tray

- Ai 34-8921-01 12cm
- Ai 34-8921-02 15cm
- Ai 34-8921-03 18cm
- Ai 34-8921-04 20cm
- Ai 34-8921-05 25cm
- Ai 34-8921-06 28cm
- Ai 34-8921-07 30cm



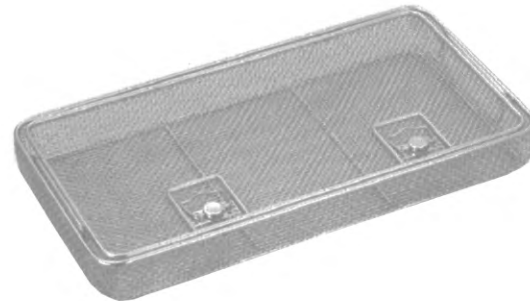
Kidney Tray (with cover)

- Ai 34-8922-01 15cm
- Ai 34-8922-02 20cm
- Ai 34-8922-03 25cm
- Ai 34-8922-04 30cm



Wire Mesh Tray

- Ai 34-8923-01 240x250x5mm
- Ai 34-8923-02 480x250x5mm
- Ai 34-8923-03 550x250x5mm
- Ai 34-8923-04 240x250x7mm
- Ai 34-8923-05 480x250x7mm
- Ai 34-8923-06 240x250x10mm
- Ai 34-8923-07 480x250x10mm



Wire Mesh Tray with Lid

- Ai 34-8924-01 240x250x5mm
- Ai 34-8924-02 480x250x5mm
- Ai 34-8924-03 550x250x5mm
- Ai 34-8924-04 240x250x7mm
- Ai 34-8924-05 480x250x7mm
- Ai 34-8924-06 240x250x10mm
- Ai 34-8924-07 480x250x10mm



Perforated Tray

- Ai 34-8925-01 200x100x40mm
- Ai 34-8925-02 250x120x50mm
- Ai 34-8925-03 300x150x50mm
- Ai 34-8925-04 350x170x50mm
- Ai 34-8925-05 400x200x50mm



Instruments Tray without Lid

- Ai 34-8926-01 100x150x25mm
- Ai 34-8926-02 150x200x40mm
- Ai 34-8926-03 200x250x45mm
- Ai 34-8926-04 250x300x50mm
- Ai 34-8926-05 300x350x50mm
- Ai 34-8926-06 150x300x50mm
- Ai 34-8926-07 200x300x50mm
- Ai 34-8926-08 230x150x50mm



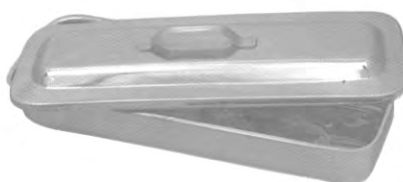
Instruments Tray with Lid

- Ai 34-8927-01 100x150x25mm
- Ai 34-8927-02 150x200x40mm
- Ai 34-8927-03 200x250x45mm
- Ai 34-8927-04 250x300x50mm
- Ai 34-8927-05 300x350x50mm
- Ai 34-8927-06 150x300x50mm
- Ai 34-8927-07 200x300x50mm
- Ai 34-8927-08 230x150x50mm

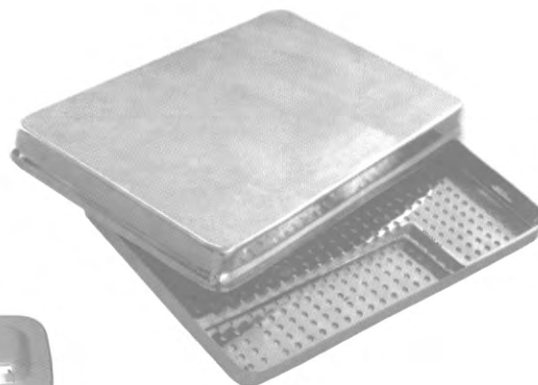




Burr Tray
 Ai 34-8928-01
 190x100x20mm



Cathetes Tray with Lid
 Ai 34-8929-01 300x80x40mm
 Ai 34-8929-02 350x90x45mm
 Ai 34-8929-03 400x100x50mm



Scaler Tray with cover
 Ai 34-8930-01
 200x100x16mm



**Instruments Box
 with Hooks**

- Ai 34-8931-01 170x70x30mm
- Ai 34-8931-02 180x80x40mm
- Ai 34-8931-03 200x100x40mm
- Ai 34-8931-04 230x120x50mm
- Ai 34-8931-05 250x125x50mm
- Ai 34-8931-06 300x150x50mm
- Ai 34-8931-07 350x170x50mm
- Ai 34-8931-08 400x200x90mm
- Ai 34-8931-09 500x200x120mm



Instruments Box

- Ai 34-8932-01 170x70x30mm
- Ai 34-8932-02 180x80x40mm
- Ai 34-8932-03 200x100x40mm
- Ai 34-8932-04 230x120x50mm
- Ai 34-8932-05 250x125x50mm
- Ai 34-8932-06 300x150x50mm
- Ai 34-8932-07 350x170x50mm
- Ai 34-8932-08 400x200x90mm
- Ai 34-8932-09 500x200x120mm



**Instruments Box
 Perforated**

- Ai 34-8933-01 200x100x40mm
- Ai 34-8933-02 250x150x40mm
- Ai 34-8933-03 300x150x40mm



Electric Sterilizer

- Ai 34-8934-01 200x100x120mm
- Ai 34-8934-02 250x120x140mm
- Ai 34-8934-03 300x150x150mm
- Ai 34-8934-04 350x170x170mm
- Ai 34-8934-05 400x200x180mm
- Ai 34-8934-06 450x230x190mm



Non Electric Sterilizer

- Ai 34-8935-01 200x100x65mm
- Ai 34-8935-02 250x125x65mm
- Ai 34-8935-03 300x150x100mm
- Ai 34-8935-04 350x170x65mm
- Ai 34-8935-05 400x200x100mm



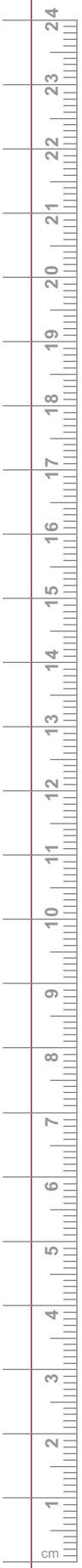
Electric Sterilizer
 Ai 34-8936-01
 280x125x65mm

- Ai 34-8937-01 125x80mm
- Ai 34-8937-02 125x120mm
- Ai 34-8937-03 150x100mm
- Ai 34-8937-04 150x150mm
- Ai 34-8937-05 180x180mm
- Ai 34-8937-06 190x140mm
- Ai 34-8937-07 190x190mm
- Ai 34-8937-08 200x200mm
- Ai 34-8937-09 240x120mm
- Ai 34-8937-10 240x240mm
- Ai 34-8937-11 290x140mm
- Ai 34-8937-12 290x240mm
- Ai 34-8937-13 290x290mm
- Ai 34-8937-14 340x160mm
- Ai 34-8937-15 340x340mm
- Ai 34-8937-16 390x150mm
- Ai 34-8937-17 390x200mm
- Ai 34-8937-18 390x290mm



Sterilizer Drum





Bedpan Hand Made
 Ai 34-8938-01
 Standard



Bedpan Hand Made
 Ai 34-8939-01 Adult
 Ai 34-8939-02 Child



Bedpan Hand Made
 Ai 34-8940-01
 Standard



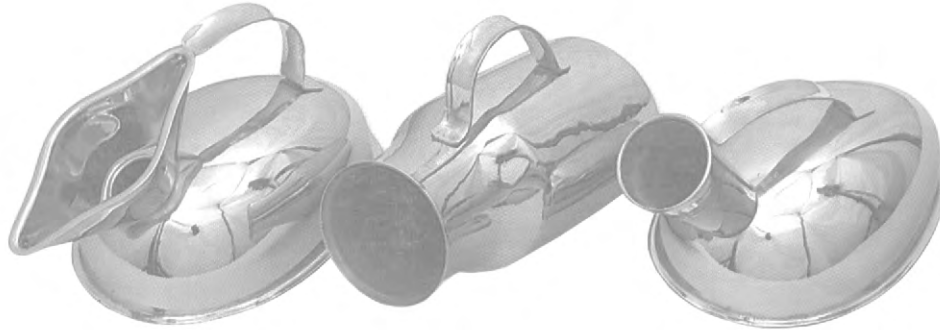
**Bedpan Simple
 pressed body with handle**
 Ai 34-8942-01 Adult
 Ai 34-8942-02 Child



Bedpan Sleeper Type
 Ai 34-8943-01 Adult
 Ai 34-8943-02 Child



Bedpan Chamber Port
 Ai 34-8944-01
 Standard



Urinal Female
 Ai 34-8945-01
 Standard

Urinal Male Vertical
 Ai 34-8946-01
 Standard

Urinal Male
 Ai 34-8947-01
 Standard



**Bedpan perfection
 type seamless**
 Ai 34-8948-01
 350x300mm



Bedpan perfection type
 Ai 34-8949-01 370x290mm
 Ai 34-8949-02 320x240mm



Measuring Jug
 Ai 34-8950-01 0.5 Ltr
 Ai 34-8950-02 1.0 Ltr
 Ai 34-8950-03 1.5 Ltr
 Ai 34-8950-04 2.0 Ltr



Pail/Bucket with Lid
 Ai 34-8951-01 06 Ltr
 Ai 34-8952-02 10 Ltr
 Ai 34-8952-03 15 Ltr



Douch Can/Irrigator
 Ai 34-8952-01 1.0 Ltr
 Ai 34-8952-02 1.5 Ltr
 Ai 34-8952-03 2.0 Ltr

