

Edition 2021

Catalogue  
**DENTAL**  
Instruments



**ASIM**   
**Instruments**

**A SOURCE OF QUALITY INSTRUMENTS**  
Manufacturers, & Exporters of Surgical Dental, Orthodontic,  
Hollow Wears & Manicure Instruments.

## COMPANY:

**ASIM INSTRUMENTS** is a leading a global instruments manufacturing Company that manufacture and export Dental, Surgical & Medical Instruments as well as Veterinary instruments used in a variety of complex medical procedures. We have been established for over 30 year global reputation for Quality, excellence and outstanding services. The company is dedicated to enlighten all of its promoters, partners, honorable clients, distributors and medical professionals about the facility it is capable to provide.

**ASIM INSTRUMENTS** has its Headquarters at Sialkot (Pakistan), from where it supplies its instruments to all over the world, as well as, looks after the progress of its sole representatives in selected regions of the world, gradually growing its business around the globe..

## OUR PRODUCTS:

ASIM INSTRUMENTS specialize in manufacturing

- Dental Instruments
- Surgical instruments
- Medical instruments
- Veterinary Instruments
- Beauty Care Instruments
- Hollow Ware Instruments

## QUALITY POLICY:

**Quality:** We manufacture the instruments and packing exactly according to the customer demand. **Function:** Our products always perfect for the function they are made for. **Feature:** We carry out all the necessary tests, inspections and process control activities to ensure that there is no problem with the products. We will also give the technical specifications to improve the confidence of the customer.

**Reliability:** We give our customer the guarantee that there our Products are reliable in use even after using it up till extended period of time. Our Products will perform their function efficiently more than any other product of similar nature in the market. All the Products are made in our own facility by the workers who are best in their workmanship, and commitment.

## ACHIEVEMENTS:

ASIM INSTRUMENTS have successfully achieved the approval of **cGMP, CE Mark, ISO 9001:2000.**



**A SOURCE OF QUALITY INSTRUMENTS**

Manufacturers, & Exporters of Surgical Dental, Orthodontic,  
Hollow Wears & Manicure Instruments.

Airport Road P.O. Gohadpur, Sialkot-51360-Pakistan.

Tell: +92-52-4270310 Cell: +92-300-8617050

E-mail: [asim@asiminst.com](mailto:asim@asiminst.com) [info@asiminst.com](mailto:info@asiminst.com)

URL: [www.asiminst.com](http://www.asiminst.com)



01

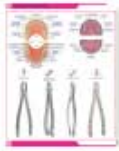

**EXTRACTING FORCEPS**

Page # 01 - 14H

02



**ROOT ELEVATORS**

Page # 15 - 29

03



**DIAGNOSTIC, PROBES, SCALERS, FILLING & LABORATORY INSTRUMENTS**

Page # 30 - 77

04



**MAXILLOFACIAL SURGERY INSTRUMENTS**

Page # 78 - 95

05



**ORTHODONTIC INSTRUMENTS & PLIERS**

Page # 96 - 107

06



**DENTAL IMPLANT INSTRUMENTS**

Page # 108 - 142

07

**IMPRESSION TRAY & HOLLOW WARES**

Page # 143 - 148

08

**MISCELLANEOUS INSTRUMENTS**

Page # 149 - 217

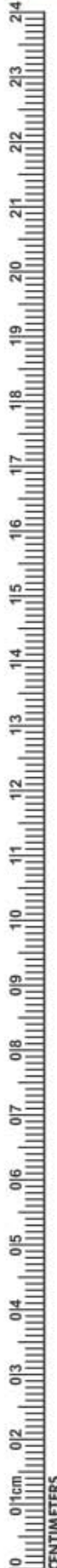

**EXTRACTING FORCEPS**

**Handle Selection For Extracting Forceps**

Dear Valued Buyers if any Universal Fig. No. of Extracting Forceps not Found in our Catalogue you Can Refer the Fig. No. From These Diagram.

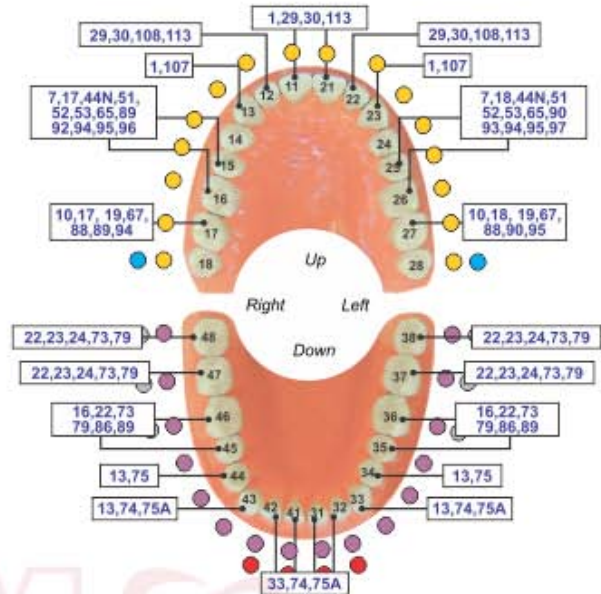
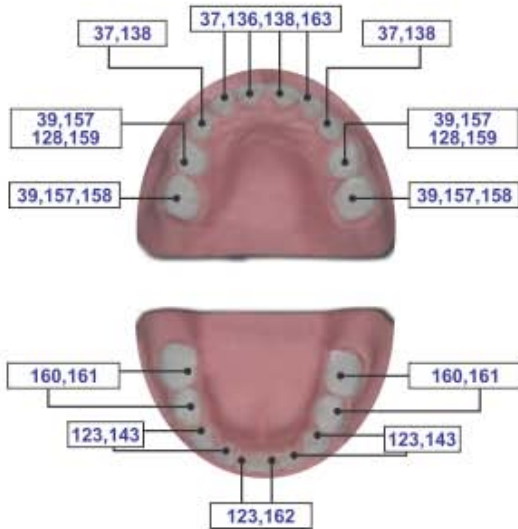

Dear Valued Buyers these are our Handle Styles



English Pattern



English Pattern



English Pattern, Anatomical Handle



American Pattern



Deep Grip Forceps With Hole Pattern



Hole Pattern



**A**



**B**



**C**



**D**



**E**



**F**



## EXTRACTING FORCEPS (English Pattern)

- Щипцы экстракционные (английская форма)
- Daviers (Forme Anglaise)
- Zahnzangen (Englische Form)

- Щипці екстракційні (англійська форма)
- Forceps de Extracción (Forme Inglesa)
- استخراج الملقط (نمط اللغة الإنجليزية)



**DE-001**  
Fig. 1  
Upper Centrals  
and Canines



**DE-002**  
Fig. 2  
Upper Laterals  
and Canines



**DE-003**  
Fig. 4  
Lower Incisors  
and Canines



**DE-004**  
Fig. 7  
Upper Premolars



**DE-005**  
Fig. 8  
Lower Premolars



**DE-006**  
Fig. 13  
Lower Premolars



**DE-007**  
Fig. 17  
Upper Molars,  
Right



**DE-008**  
Fig. 18  
Upper Molars,  
Left



**DE-009**  
Fig. 21  
Lower Molar



**DE-010**  
Fig. 22  
Lower Molar



**EXTRACTING FORCEPS (English Pattern)**

- Щипцы экстракционные (английская форма)
- Давиеры (Forme Anglaise)
- Zahnzangen (Englische Form)
- Щипці екстракційні (англійська форма)
- Forceps de Extracción (Forme Inglesa)
- استخراج المنقظ (نمط اللغة الإنجليزية)



**DE-011**  
**# 18A**  
upper molars



**DE-012**  
**# 19**  
upper third molars



**DE-013**  
**# 20**  
lower third molar



**DE-014**  
**# 24**  
lower molar, right



**DE-015**  
**# 29**  
upper roots



**DE-016**  
**# 30**  
Upper Roots



**DE-017**  
**# 33**  
lower roots



**DE-018**  
**# 33A**  
Lower Roots



**DE-019**  
**# 33M**  
Lower roots  
with long beak



**DE-020**  
**# 46L**



**DE-021**  
**# 51**  
Upper Roots



**DE-022**  
**# 51A**  
Upper Roots



## EXTRACTING FORCEPS (English Pattern)

- Щипцы экстракционные (английская форма)
- Щипці екстракційні (англійська форма)
- Daviers (Forme Anglaise)
- Forceps de Extracción (Forme Inglesa)
- Zahnzangen (Englische Form)
- استخراج الملقط (نمط اللغة الإنجليزية)

### WISDOM EXTRACTING FORCEPS



**DE-023**  
Routurier  
(# 22 ½ L)  
lower molars and  
wisdoms, left

**DE-024**  
Routurier  
(# 22 ½ R)  
lower molars and  
wisdoms, right



**DE-025**  
Routurier  
(# 33 ½ L)  
lower molar and  
wisdom roots, left

**DE-026**  
Routurier  
(# 33 ½ R)  
lower molar and  
wisdom roots, right



**DE-027**  
Fig. 186L  
lower molars



**DE-028**  
Fig. 186R  
lower molars



**DE-029**  
# 51A1



**DE-030**  
# 67  
Upper Thrid Molars



**DE-031**  
# 67A  
Upper Thrid Molars



**DE-032**  
# 79  
Lower Third Molars



## EXTRACTING FORCEPS (English Pattern)

- Щипцы экстракционные (английская форма)
- Daviers (Forme Anglaise)
- Zahnzangen (Englische Form)
- Щипці екстракційні (англійська форма)
- Forceps de Extracción (Forme Inglesa)
- استخراج المنقط (نمط اللغة الإنجليزية)



**DE-033**  
**# 73**  
Lower Molars



**DE-034**  
**# 73 A**  
lower molars



**DE-035**  
**# 73 S**



**DE-036**  
**# 74**  
Lower Roots



**DE-037**  
**# 74N**  
Lower Roots



**DE-038**  
**# 75**  
Lower Premolars



**DE-039**  
**# 86A**  
Lower Molars



**DE-040**  
**# 86B**  
lower molars



**DE-041**  
**# 86C**  
lower molars



**DE-042**  
**# 87**  
Lower Molars



**DE-043**  
**# 89**  
Upper Molars,  
Right



**DE-044**  
**# 90**  
Upper Molars,  
Left





## EXTRACTING FORCEPS (English Pattern)

- Щипцы экстракционные (английская форма)
- Daviers (Forme Anglaise)
- Zahnzangen (Englische Form)

- Щипці екстракційні (англійська форма)
- Forceps de Extracción (Forme Inglesa)
- استخراج الملقط (نمط اللغة الإنجليزية)

A-TRAUMATIC EXTRACTION  
Improved tapered beaks for complete root contact. Cross serrations.  
Deep Gripe Extracting Forceps



- No Fracture
- No Tissue Damage
- Extraction With Easy



Thin Tip



**DE-045  
# 34**  
Upper incisors and  
premolars  
deep-gripping



Wide Tip



**DE-046  
# 34A**  
Upper centrals / cains  
deep-gripping



Thin Tip



**DE-047  
Fig. 35**  
upper permolars  
deep-gripping



Wide Tip



**DE-048  
# 35A**  
Upper incisors and  
premolars  
deep-gripping



Thin Tip



**DE-049  
# 36**  
Lower premolars  
deep-gripping



Wide Tip



**DE-050  
# 36A**  
Lower premolars  
deep-gripping



**DE-051  
# 336**  
lower permolars  
deep-gripping



**DE-052  
F-7C**  
lower molar



**DE-053  
# 9**  
Apex Forceps Lower Universal  
Deep Root Pick



**DE-054  
# 79N**  
Lower third molars  
deep-gripping



**DE-055  
# 79**  
Lower Thrid Molars

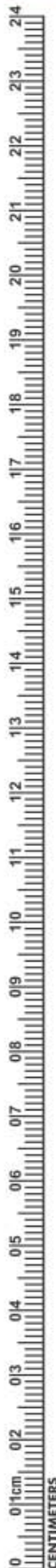

**EXTRACTING FORCEPS (English Pattern)**

- Щипцы экстракционные (английская форма)
- Давиеры (Forme Anglaise)
- Zahnzangen (Englische Form)
- Щипці екстракційні (англійська форма)
- Forceps de Extracción (Forme Inglesa)
- استخراج المنقط (نمط اللغة الإنجليزية)

**DEEP GRIP FORCEPS**



**DE-056  
# 146**

Apex Forceps Lower Root  
Deep Root Pick



**DE-057  
# 153**

Apex Forceps Upper Root  
Deep Root Pick



**DE-058  
# 149**

Apex Forceps Upper Root  
Deep Root Pick



**DE-061  
Fig. 44**



**DE-060  
Fig. 44Z**



**DE-059  
Fig. 45Z**



**DE-062  
# 46XL**  
Apex Forceps Lower Root  
Deep Root Pick



**DE-063  
# 67**  
Upper Third Molars



**DE-064  
# 67A**  
Upper Third Molars



**DE-065  
# 67N**  
Lower third molars  
deep-gripping



**DE-066  
# 331**  
upper roots  
deep-gripping



## EXTRACTING FORCEPS (English Pattern)

- Щипцы экстракционные (английская форма)
- Щипці екстракційні (англійська форма)
- Daviers (Forme Anglaise)
- Forceps de Extracción (Forme Inglesa)
- Zahnzangen (Englische Form)
- استخراج الملقط (نمط اللغة الإنجليزية)

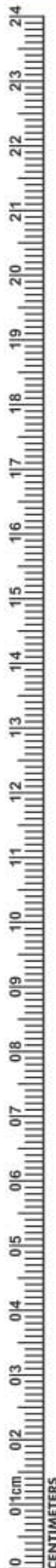

Fig. 1  
upper  
laterals  
and canines



**DE-067** Set of 10 Pieces

- Fig. 1
- Fig. 7
- Fig. 13
- Fig. 17
- Fig. 18
- Fig. 22
- Fig. 51A
- Fig. 67
- Fig. 74N
- Fig. 79

Fig. 7  
upper  
premolars



Fig. 13  
lower  
premolars



Fig. 17  
upper  
molars,  
right



Fig. 18  
upper  
molars,  
left



Fig. 22  
lower  
roots



Fig. 51A  
upper roots



Fig. 67  
upper third  
molars



Fig. 74N  
lower  
molar



Fig. 79  
lower third  
molars



# EXTRACTING FORCEPS

- Щипцы экстракционные
  - Daviers
  - Zahnzangen
- Щипці екстракційні
  - Forceps de Extracción
  - استخراج الملقط

## Pediatric Tooth Extracting Forceps Set



**DE-069**  
English Pattern Klein #51S  
Pedodontic Upper root



**DE-068**  
English Pattern Klein #137  
Pedodontic, Upper Incisors Spring handle



**DE-072**  
English Pattern Klein #5  
Pedodontic Lower Incisors.



**DE-070**  
English Pattern Klein #139  
Pedodontic Upper Premolars

### Baby Tooth Extraction Forceps



Fig. # 01 to 07  
Set of 7 Pieces



**DE-073**  
English Pattern Klein #7  
Pedodontic Lower Roots,



**DE-071**  
English Pattern Klein #3  
Pedodontic Upper Molars Universal

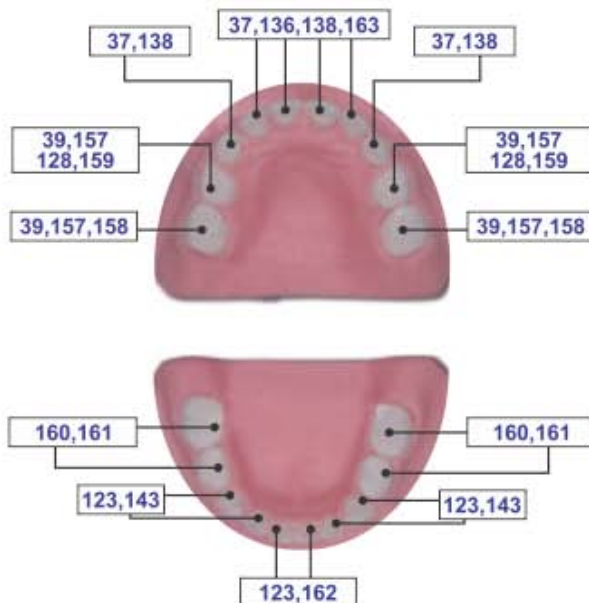

**DE-074**  
English Pattern Klein #6  
Pedodontic Lower Molars, Spring Handle



EXTRACTING FORCEPS (American Pattern)

- Щипцы экстракционные (американская форма)
- Daviers - forme américaine
- Fôrceps de extracción - forma americana
- Щипці екстракційні (американська форма)
- Pinzoper per estrazione - forma americana
- استخراج المنطق (النمط الأمريكي)



**DE-075**  
# 1STD  
Winter  
upper centrals and canines

**DE-076**  
Fig. 1  
upper incisors  
and roots

**DE-077**  
Cryer  
Fig. 150



## EXTRACTING FORCEPS (American Pattern)

- Щипцы экстракционные (американская форма)
- Щипці екстракційні (американська форма)
- Daviers - forme américaine
- Pinzere per estrazione - forma americana
- Fórceps de extracción - forma americana
- استخراج المنقط (النمط الأمريكي)



**DE-079**

Fig. 62

incisors, premolars,  
deciduous teeth



**DE-080**

# 10S

upper roots



**DE-081**

# 17

lower molars



**DE-082**

Harris

Fig. 18R



**DE-083**

Harris

Fig. 18L



**DE-078**

Fig. 150A

Cryer

upper incisors, premolars, roots



INCHES

EXTRACTING FORCEPS (American Pattern)

- Щипцы экстракционные (американская форма)
- Daviers - forme américaine
- Fôrceps de extracción - forma americana
- Щипці екстракційні (американська форма)
- Pinzaper per estrazione - forma americana
- استخراج المنقط (النمط الأمريكي)



DE-084  
Fig. 210  
upper third molars



DE-085  
Fig. 53R  
upper molars, right



DE-086  
Fig. 53L  
upper molars, left



DE-087  
NEVIUS  
Fig. 88R

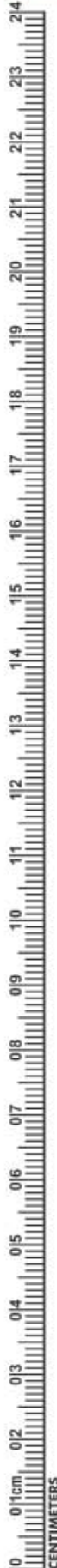

**EXTRACTING FORCEPS (American Pattern)**

- Щипцы экстракционные (американская форма)
- Daviers - forme américaine
- Férceps de extracción - forma americana
- Щипці екстракційні (американська форма)
- Pinzoper per estrazione - forma americana
- استخراج المنقط (النمط الأمريكي)



**DE-088**  
Fig. 24  
upper molars



**DE-089**  
# 210S  
upper third molars



**DE-090**  
# 210H  
upper third molars



**DE-091**  
# 286  
Upper Roots,  
Premolars, Incisors



**DE-092**  
# 99C  
Kells  
upper incisors,  
canines, premolars



**DE-093**  
# 222  
lower third molars



**DE-094**  
# 286  
Lower Molar





## EXTRACTING FORCEPS (American Pattern)

- Щипцы экстракционные (американская форма)
- Daviers - forme américaine
- Fôrceps de extracción - forma americana
- Щипці екстракційні (американська форма)
- Pinzaper per estrazione - forma americana
- استخراج المنقط (النمط الأمريكي)



**DE-095**  
Nevius  
Fig. 88L  
upper molars, left



**DE-096**  
Fig. 65  
upper incisors  
and roots



**DE-097**  
Parmly Fig. 32A  
upper premolars  
and roots



**DE-098**  
Parmly Fig. 32  
upper premolars  
and molars



**EXTRACTING FORCEPS (American Pattern)**

- Щипцы экстракционные (американская форма)
- Dавiers - forme américaine
- Fórceps de extracción - forma americana
- Щипці екстракційні (американська форма)
- Pinzere per estrazione - forma americana
- استخراج المنقط (النمط الأمريكي)

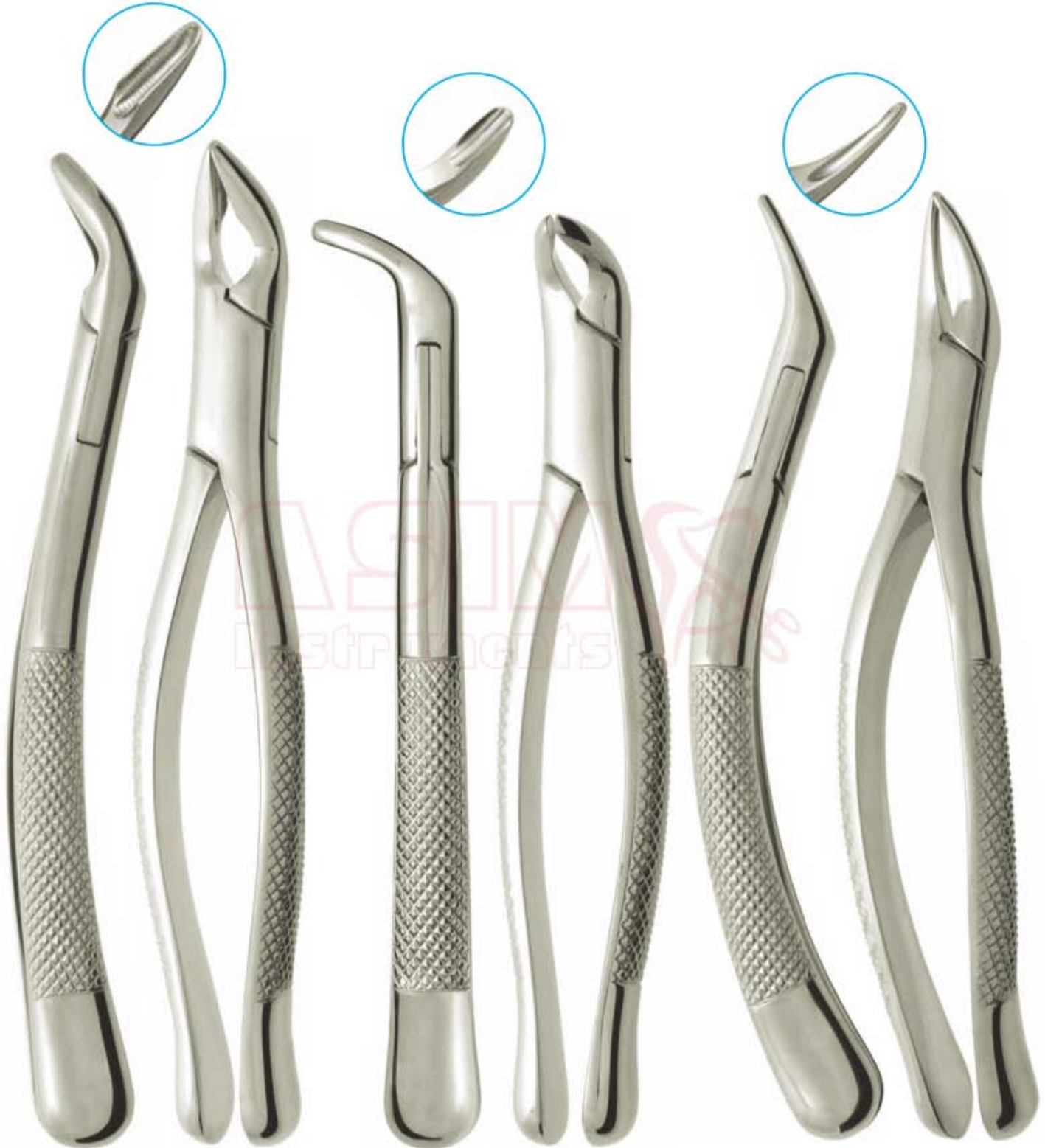

**DE-099**  
COHEN  
universal

**DE-100**  
Fig. 203  
lower incisors  
and roots

**DE-101**  
Tomes Fig. 69  
upper and lower  
roots

EXTRACTING FORCEPS (American Pattern)

- Щипцы экстракционные (американская форма)
- Daviers - forme américaine
- Fôrceps de extracción - forma americana
- Щипці екстракційні (американська форма)
- Pinzoper per estrazione - forma americana
- استخراج المنقط (النمط الأمريكي)



**DE-102**  
Fig. 23  
lower molars

**DE-103**  
Fig. 16  
lower molars

**DE-104**  
Physic Fig. 5  
lower third molars



**DE-105**  
Harris Fig. 15  
lower molars



**DE-106**  
Fig. 103

**EXTRACTING FORCEPS (American Pattern)**

- Щипцы экстракционные (американская форма)
- Daviers - forme américaine
- Fôrceps de extracción - forma americana
- Щипці екстракційні (американська форма)
- Pinzeta per estrazione - forma americana
- استخراج المنقط (النمط الأمريكي)

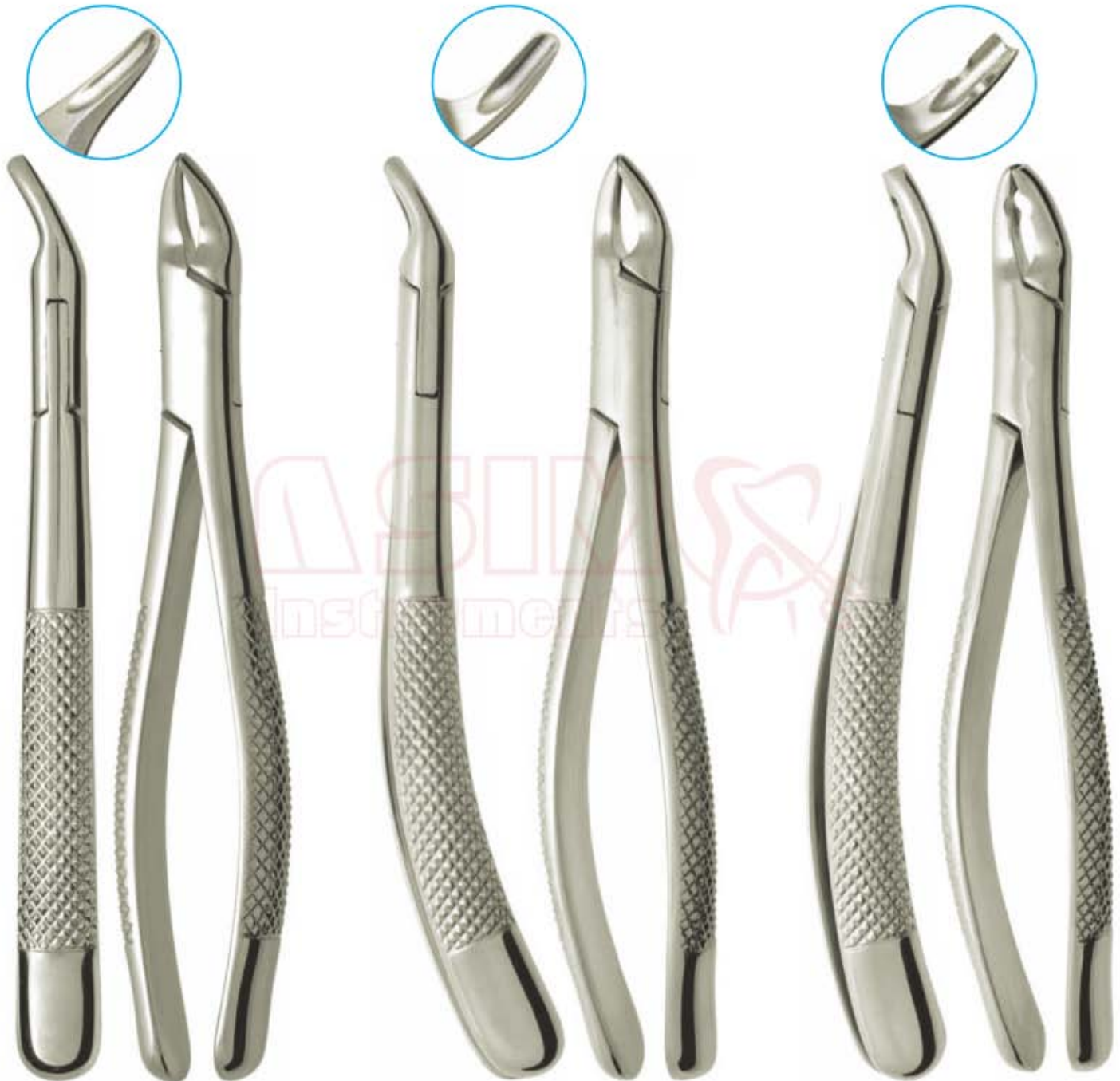

**DE-107**  
Hull  
Fig. 101  
Deciduous teeth

**DE-108**  
Cryer  
Fig. 150S  
upper teeth,  
for children

**DE-109**  
Fig. 150 AS

EXTRACTING FORCEPS (American Pattern)

- Щипцы экстракционные (американская форма)
- Daviers - forme américaine
- Fôrceps de extracción - forma americana
- Щипці екстракційні (американська форма)
- Pinzaper per estrazione - forma americana
- مستفراج المنقط (النمط الأمريكي)



**DE-110**  
Cryer  
Fig. 151  
lower teeth,  
for children

**DE-111**  
Fig. 151 S  
lower incisors,  
premolars, roots

**DE-112**  
Fig. 151 AS

**EXTRACTING FORCEPS (American Pattern)**

- Щипцы экстракционные (американская форма)
- Daviers - forme américaine
- Férceps de extracción - forma americana
- Щипці екстракційні (американська форма)
- Pinzere per estrazione - forma americana
- استخراج المنقط (النمط الأمريكي)



**DE-113  
# 16S**  
lower molars for children



**DE-114  
# 17S**  
lower molars



**DE-115  
# 23 S**  
Lower molars

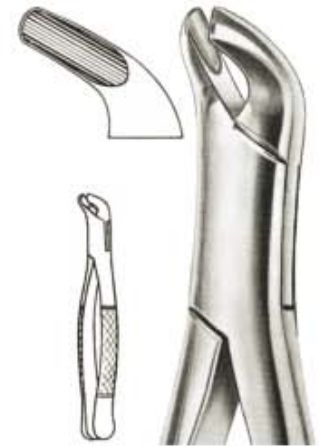

**DE-116  
# 27**  
lower molars



**DE-117  
# 18LS**  
upper molars left



**DE-118  
# 18RS**  
upper molars right



**DE-119  
# 85 Tomas**  
lower canines, premolars and molars



**DE-120  
# 85A Tomas**  
lower canines, premolars and molars



**DE-121  
# 69S**  
upper and lower roots



**DE-122  
# 99A Kells**  
upper incisors, canines, premolars



**DE-123  
# 217**  
lower molars



**EXTRACTING FORCEPS (American Pattern)**

- Щипцы экстракционные (американская форма)
- Daviers - forme américaine
- Fôrceps de extracción - forma americana
- Щипці екстракційні (американська форма)
- Pinzoper per estrazione - forma americana
- مستفراج المنقط (النمط الأمريكي)

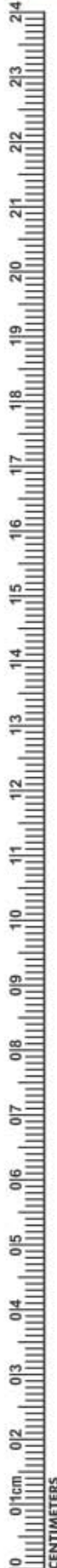

**DE-124**  
**#10 SK**  
Upper Molars Sup



**DE-125**  
**#17 SK Universal**  
Lower Molars



**DE-126**  
**#23 SK Universal**  
Upper Molars



**DE-127**  
**#69 SK Tomas**  
upper and lower roots



**DE-128**  
**#99 SK**  
upper incisors,  
canines, premolars



**DE-129**  
**#150 SK**  
upper incisors,  
premolars, roots



**DE-130**  
**#151 SK**  
lower incisors,  
premolars, roots



**DE-131**  
**#222 SK**  
lower third molars

**EXTRACTING FORCEPS (American Pattern)**

- Щипцы экстракционные (американская форма)
- Daviers - forme américaine
- Fórceps de extracción - forma americana
- Щипці екстракційні (американська форма)
- Pinzere per estrazione - forma americana
- استخراج المنطق (النمط الأمريكي)



**DE-132**  
Fig. 1  
Upper Anterior

**DE-133**  
Lower Molar  
Fig. 23 Cow Horn



**DE-134**  
Fig. 74  
Lower Anterior



**DE-135**  
Fig. 88L  
Upper Molar Left



**DE-136**  
Fig. 88R  
Upper Molar Right



**DE-137**  
Fig. 74  
Lower Anterior



**DE-138**  
Fig. 106  
Lower Incisors



**DE-139**  
Fig. 174  
Extra Narrow  
Lower Anterior  
Apical Retention  
Forceps



**DE-140**  
Fig. 859  
Lower Molars  
Roots





DENTAL SYRINGES



- Шприцы стоматологические карпульные
  - Seringues à usage dentaire
  - Dentsalspritzen
- Шприцы стоматологічні карпульні
  - Jeringas dentales
  - المحاقن الأسنان



DE-141 1.8ML  
DE-142 2.2ML



DE-143 1.8ML  
DE-144 2.2ML



DE-145 1.8ML  
DE-146 2.2ML



DE-147 1.8ML  
DE-148 2.2ML



DE-149 1.8ML  
DE-149A 2.2ML



DE-149B 1.8ML  
DE-149C 2.2ML



DE-149D  
# 1001  
Intraligamental  
Anesthesia  
Syringe in  
Black Colour



DE-149E 1.8ML  
DE-149F 2.2ML  
Angled



DE-149G  
Aluminium - Dark 1.8 ml

- |   |   |  |                                       |
|---|---|--|---------------------------------------|
|   |   |  |                                       |
| DE-149H<br>Aluminium -<br>Silver 1.8 ml | DE-149I<br>Aluminium -<br>Orange 1.8 ml | DE-149J<br>Aluminium -<br>Green 1.8 ml | DE-149K<br>Aluminium -<br>Blue 1.8 ml |



Type C  
DE1-149 1,8ml.  
DE2-149 2,2ml



Type C  
DE3-149 1,8ml  
DE4-149 2,2ml



2-Ring  
DE5-149 1,8ml.  
DE6-149 2,2ml



Aspirating Syringe  
DE7-149 1.8mm  
DE8-149 2.2mm



Cartridge Syringe  
DE9-149 1.8mm  
DE10-149 2.2mm



Cartridge Syringe  
DE11-149 1.8mm  
DE12-149 2.2mm



Cartridge Syringe  
DE13-149 1.8mm  
DE14-149 2.2mm

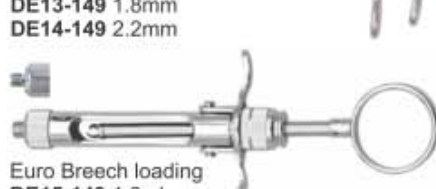

Euro Breech loading  
DE15-149 1.8ml  
DE16-149 2.2ml

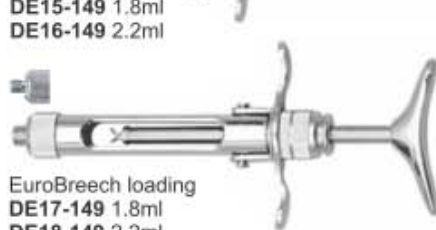

EuroBreech loading  
DE17-149 1.8ml  
DE18-149 2.2ml



Manual Aspirating Syringe  
DE19-149 1.8ml  
DE20-149 2.2ml



Quatro  
DE21-149 1.8ml  
DE22-149 2.2ml

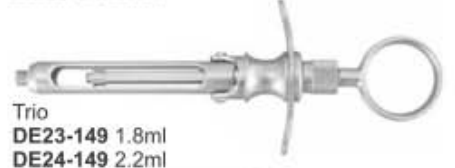

Trio  
DE23-149 1.8ml  
DE24-149 2.2ml



Swedish Type  
DE25-149 1.8ml  
DE26-149 2.2ml



Ject Ultima  
DE27-149 1.8ml  
DE28-149 2.2ml  
Injects 0,05 ml with every click Supplied with  
angled and straight tubes

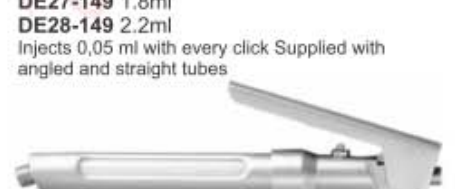

Ject angled  
DE29-149 1.8ml  
DE30-149 2.2ml

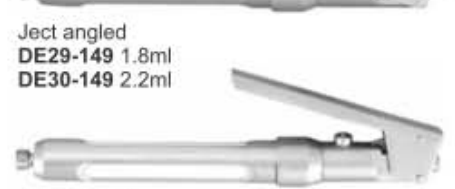

Ject Straight  
DE31-149 1.8ml  
DE32-149 2.2ml



Disc System  
DE33-149 1.8ml  
DE34-149 2.2ml



Disc System  
DE35-149 1.8ml

**BONE ROUNGER**

- Костные кусачки
- Hohlmeißelzangen
- Pincers-gouges
- Кусачки для кісток
- Pinzas-gubias
- روتجیورس العظام



DE-149L  
Blumenthal  
15cm



DE-149M  
Blumenthal  
15cm



DE-149N  
Blumenthal  
15cm



DE-149O  
Friedman  
14cm



DE-149P  
Friedman  
14.5cm



DE-149Q  
Micro-Friedman  
14cm



DE-149R  
Micro-Friedman  
15cm



DE-149S  
Micro-Friedman  
16cm



DE-149T  
Kleinert-Kutz  
18.5cm



DE-149U  
Beyer  
18.5cm



DE-149V  
Mead 1A  
18.5cm



DE-149W  
Luer  
18.5cm



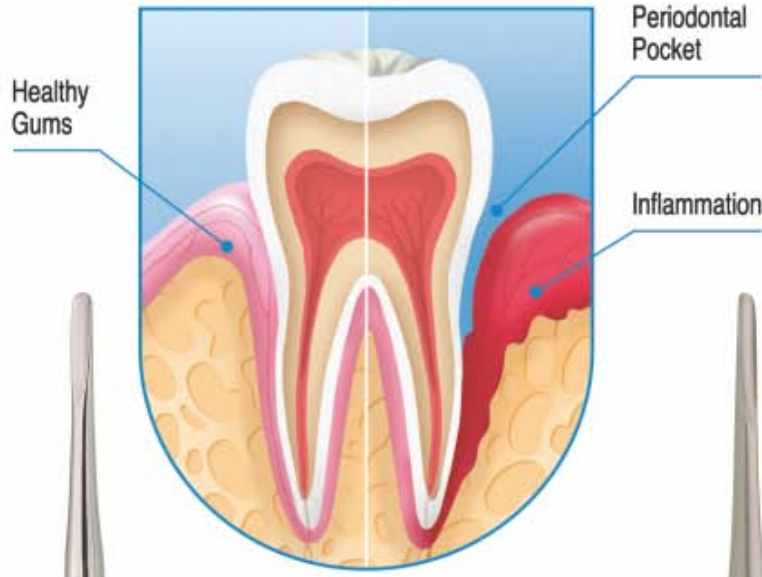

HANDLES FOR ROOT ELEVATORS POINTS A, B, C, D

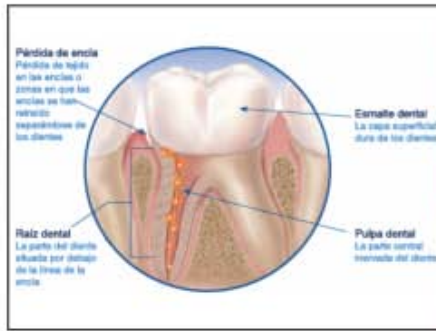

# ROOT ELEVATOR

- Элеватор корневой экстракционный
- Elévateurs à racines
- Wurzelheber
- Слеватор корневий екстракційний
- Elevadores para raices
- المصاعد الجذر

## Apexo Root Elevators



Apexo



**DE-150**  
Apexo  
2.5x9mm  
Straight



**DE-151**  
Apexo  
2.7x9mm  
Straight



**DE-152**  
Apexo  
3.0x9mm  
Straight



**DE-153**  
Apexo  
2.5x9mm  
Curved



**DE-154**  
Apexo  
3.0x9mm  
Curved



**DE-155**  
Seldin  
3.0x14mm  
Straight

## Luxator Root Elevators



Luxator



**DE-156**  
Luxator  
3mm  
straight



**DE-157**  
Luxator  
3mm  
curved



**DE-158**  
Luxator  
4mm  
straight



**DE-159**  
Luxator  
4mm  
curved



**DE-160**  
Luxator  
5mm  
straight



**DE-161**  
Luxator  
5mm  
curved

## Bein Root Elevators



Bein



**DE-162**  
Bein 2mm



**DE-163**  
Bein 3mm



**DE-164**  
Bein 4mm

## Seldin Root Elevators



Seldin



**DE-165**  
Floh 1



**DE-166**  
Seldin 34S



**DE-167**  
Seldin 34



- Элеватор корневой экстракционный
- Слеватор корневий екстракційний
- Elévateurs à racines
- Elevadores para raíces
- Wurzelheber
- المصاعد الجذر

Apexo Root Elevators



Apexo



**DE-168**  
Apexo  
2.5x9mm  
Straight



**DE-169**  
Apexo  
2.7x9mm  
Straight



**DE-170**  
Apexo  
3.0x9mm  
Straight



**DE-171**  
Apexo  
2.5x9mm  
Curved



**DE-172**  
Apexo  
3.0x9mm  
Curved



**DE-173**  
Seldin  
3.0x14mm  
Straight

Luxator Root Elevators



Luxator



**DE-174**  
Luxator  
3mm  
straight



**DE-175**  
Luxator  
3mm  
curved



**DE-176**  
Luxator  
4mm  
straight



**DE-177**  
Luxator  
4mm  
curved



**DE-178**  
Luxator  
5mm  
straight



**DE-179**  
Luxator  
5mm  
curved

Bein Root Elevators



Bein



**DE-180**  
Bein 2mm



**DE-181**  
Bein 3mm



**DE-182**  
Bein 4mm

Seldin Root Elevators



Seldin



**DE-183**  
Flohr 1



**DE-184**  
Seldin 34S



**DE-185**  
Seldin 34



# ROOT ELEVATOR

- Элеватор корневой экстракционный
- Elévateurs à racines
- Wurzelheber
- Слеватор корневий екстракційний
- Elevadores para raices
- المعساعد الجذر

## Apical Root Elevators

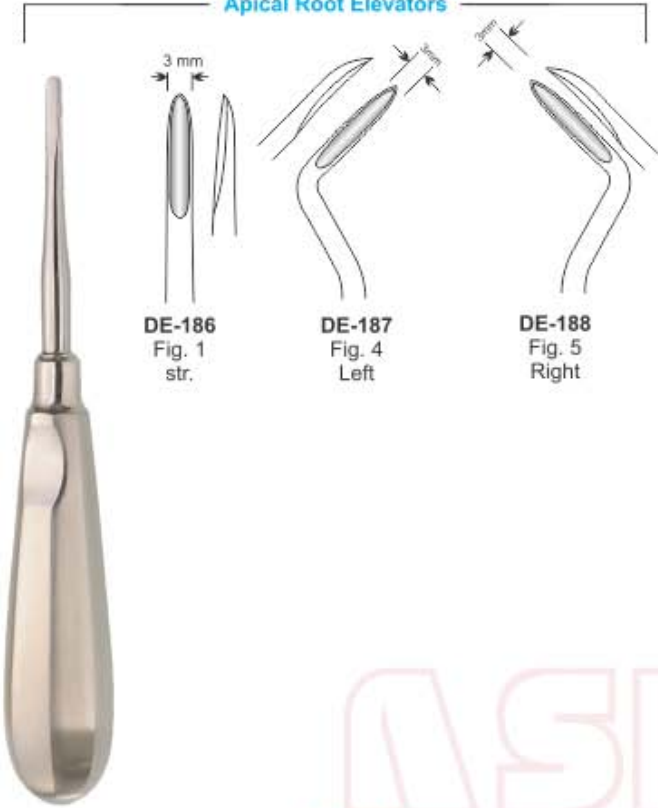

DE-186  
Fig. 1  
str.

DE-187  
Fig. 4  
Left

DE-188  
Fig. 5  
Right

## Apical Root Elevators

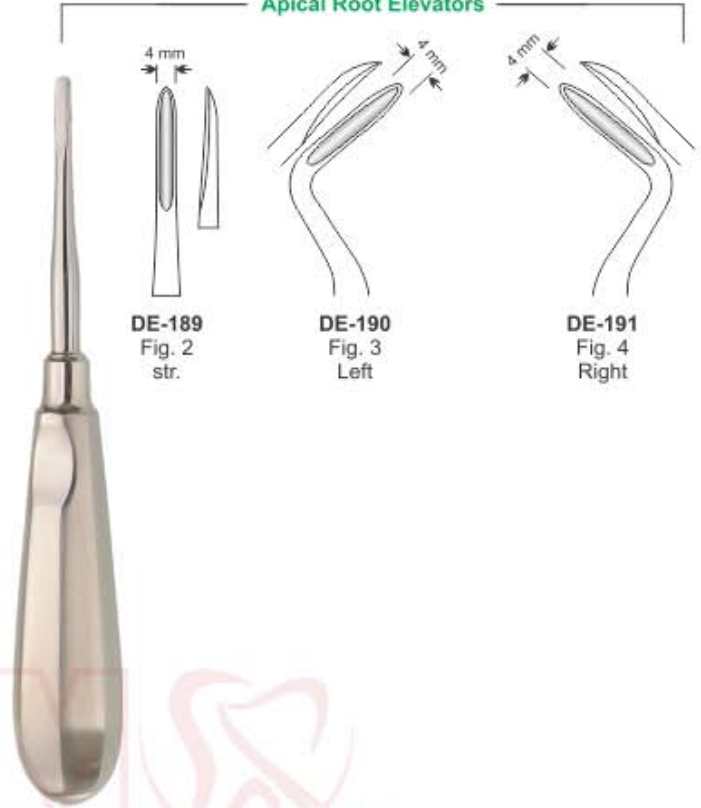

DE-189  
Fig. 2  
str.

DE-190  
Fig. 3  
Left

DE-191  
Fig. 4  
Right

## Coupland Root Elevators

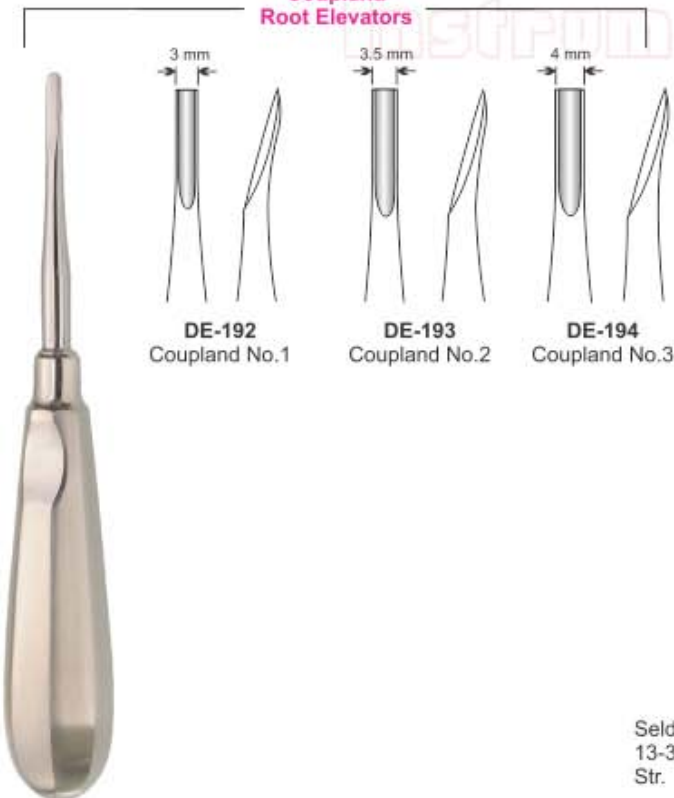

DE-192  
Coupland No.1

DE-193  
Coupland No.2

DE-194  
Coupland No.3

## Seldin Root Elevators

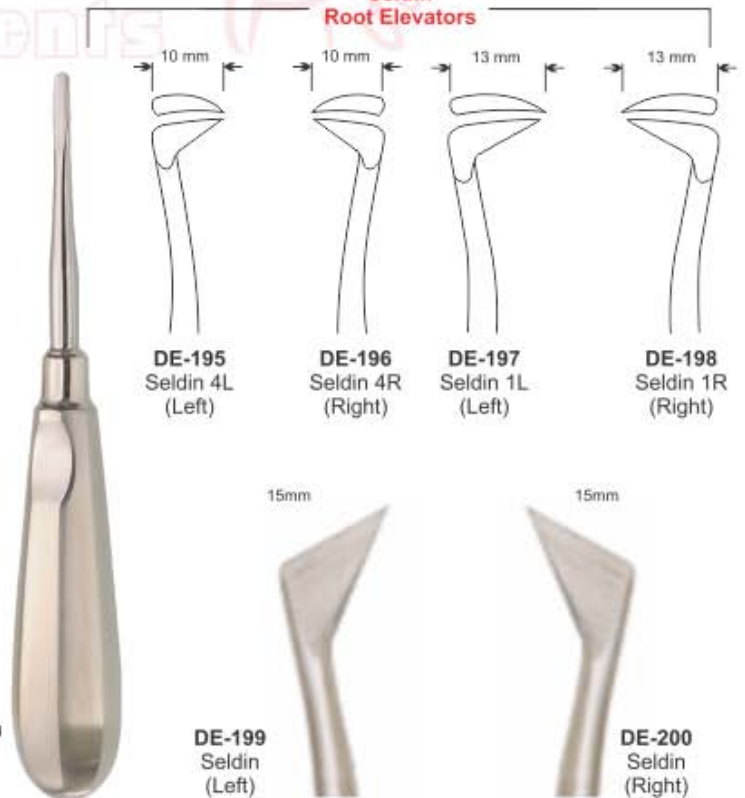

DE-195  
Seldin 4L  
(Left)

DE-196  
Seldin 4R  
(Right)

DE-197  
Seldin 1L  
(Left)

DE-198  
Seldin 1R  
(Right)

Seldin  
13-3  
Str.

DE-199  
Seldin  
(Left)

DE-200  
Seldin  
(Right)



# ROOT ELEVATOR

- Элеватор корневой экстракционный
- Elévateurs à racines
- Wurzelheber

- Єлеватор кореневий екстракційний
- Elevadores para raices
- المصاعد الجذر



### Apical Root Elevators

### Apical Root Elevators



DE-201  
Fig. 1  
Str.

DE-202  
Fig. 4  
Left

DE-203  
Fig. 5  
Right



DE-204  
Fig. 2  
Str.

DE-205  
Fig. 3  
Left

DE-206  
Fig. 4  
Right

### Coupland Root Elevators

### Seldin Root Elevators

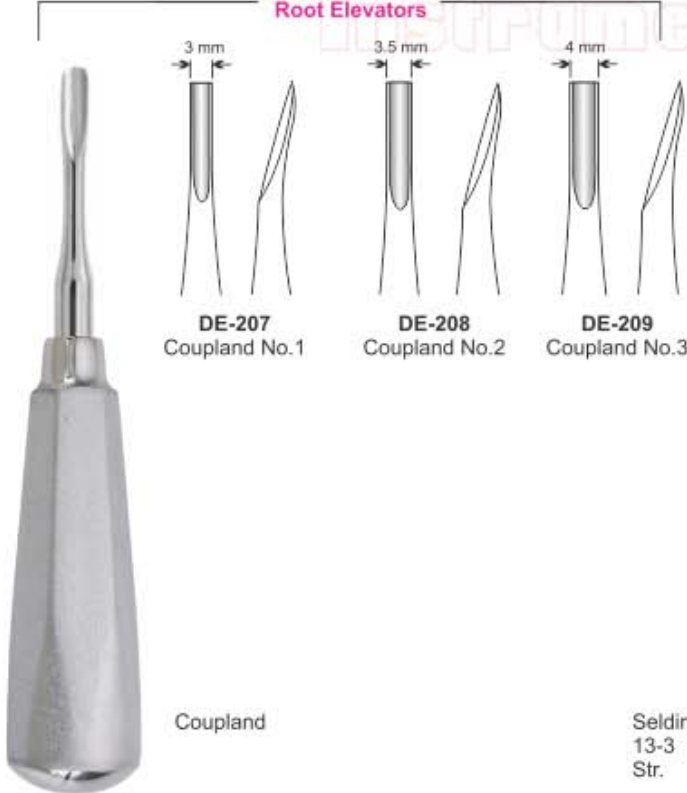

DE-207  
Coupland No.1

DE-208  
Coupland No.2

DE-209  
Coupland No.3

Coupland



DE-210  
Seldin 4L  
(Left)

DE-211  
Seldin 4R  
(Right)

DE-212  
Seldin 1L  
(Left)

DE-213  
Seldin 1R  
(Right)

Seldin  
13-3  
Str.

DE-2  
Seld  
(Lef)

DE-215  
Seldin  
(Right)

# ROOT ELEVATOR

- Элеватор корневой экстракционный
- Elévateurs à racines
- Wurzelheber
- Слеватор корневий экстракційний
- Elevadores para raices
- المعاعد الجذر

## Apical Root Elevators



## Apical Root Elevators



## Apical Root Elevators



## Laxutor Root Elevators

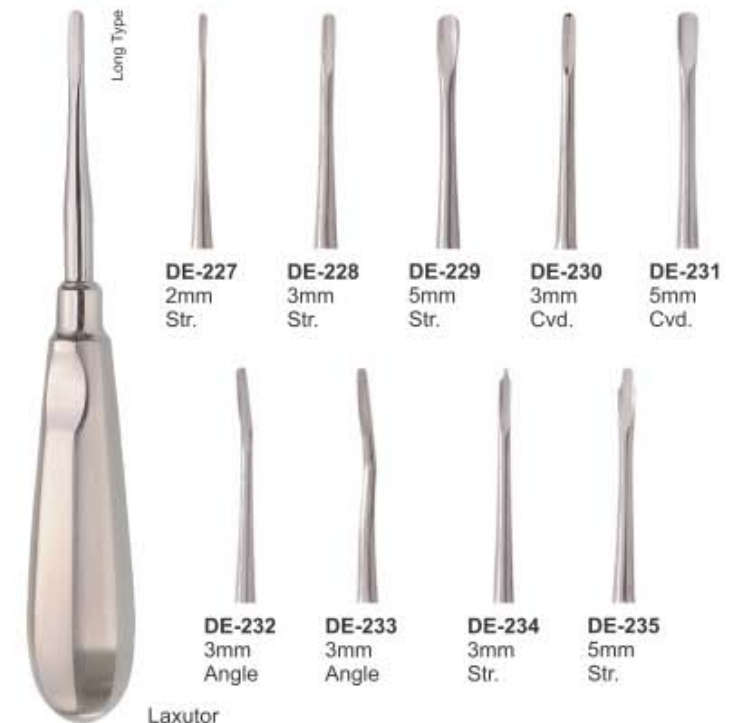



**ROOT ELEVATOR**

- Элеватор корневой экстракционный
- Elévateurs à racines
- Wurzelheber
- Слеватор корневий екстракційний
- Elevadores para raices
- المصاعد الجذر

**Lindo Levian Root Elevators**



**DE-236**  
25  
LINDO LEVIAN  
2.5x5mm  
straight

**DE-237**  
35  
LINDO LEVIAN  
3x8mm  
straight

**DE-238**  
45  
LINDO LEVIAN  
4x8mm  
straight

**DE-239**  
1  
LINDO LEVIAN  
2.5x5  
curved

**DE-240**  
2  
LINDO LEVIAN  
3x8  
curved

**DE-241**  
3  
LINDO LEVIAN  
4x8  
curved

**DE-242**  
Lindo-Levian  
Serrated Curved

**DE-243**  
Lindo-Levian  
Serrated Right

**Flohr Root Elevators**

**Heidbrink Root Elevators**

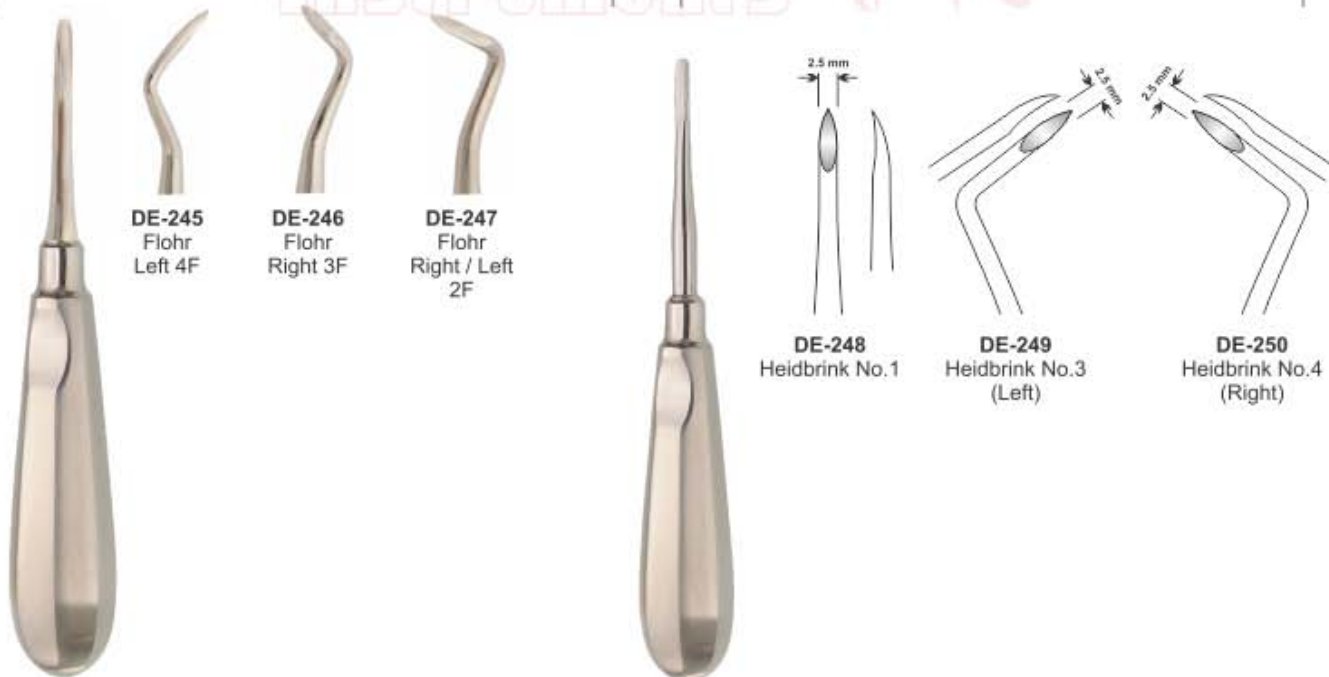

**DE-245**  
Flohr  
Left 4F

**DE-246**  
Flohr  
Right 3F

**DE-247**  
Flohr  
Right / Left  
2F

**DE-248**  
Heidbrink No.1

**DE-249**  
Heidbrink No.3  
(Left)

**DE-250**  
Heidbrink No.4  
(Right)

**DE-244**  
Flohr  
1F

Heidbrink

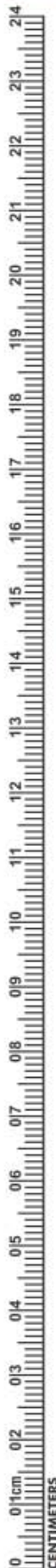

# ROOT ELEVATOR

- Элеватор корневой экстракционный
- Elévateurs à racines
- Wurzelheber
- Слеватор корневий екстракційний
- Elevadores para raices
- المصاعد الجذر

## Friedmann Roots Elevator

## Heidbrink Roots Elevator

## Wisdom Roots Elevator



DE-251  
Friedmann 4F  
Str.

DE-252  
Friedmann 5F  
Left

DE-253  
Friedmann 6F  
Right

DE-254  
Heidbrink  
Straight

DE-255  
Heidbrink  
Left

DE-256  
Heidbrink  
Right

DE-257  
Wisdom  
for 18 and 38

DE-258  
Wisdom  
for 28 and 48

## Bayonet Roots Elevator Set

## Luxator Roots Elevator



DE-259  
Left

DE-260  
Right

DE-261  
bayonet

DE-262  
Curved

DE-263  
Straight

DE-264  
Luxator  
Straight

DE-265  
Luxator  
Curved



- Элеватор корневой экстракционный
- Elévateurs à racines
- Wurzelheber
- Слеватор корневий екстракційний
- Elevadores para raices
- المصاعد الجذر

Roots Elevator

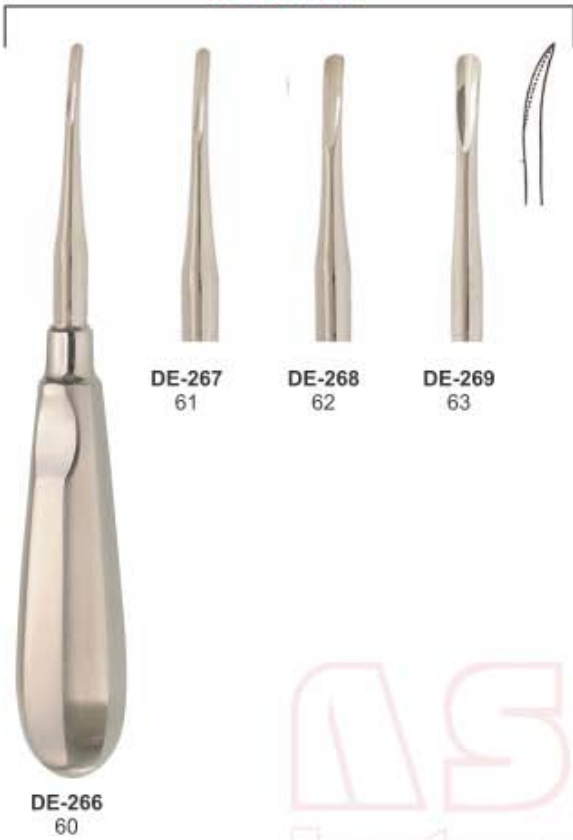

Luxier Roots Elevator



Luxier Roots Elevator

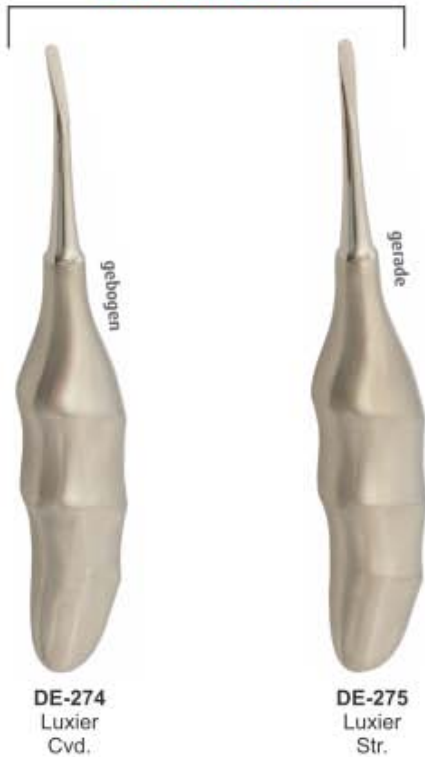

Claw-Lift Roots Elevator

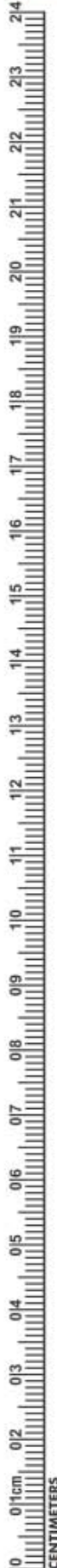

# ROOT ELEVATOR

- Элеватор корневой экстракционный
- Elévateurs à racines
- Wurzelheber
- Слеватор корневий екстракційний
- Elevadores para raices
- المصاعد الجذر

## Hylin Roots Elevator

## Cryer Roots Elevator



## Kopp Roots Elevator



**ROOT ELEVATOR**

- Элеватор корневой экстракционный
- Elévateurs à racines
- Wurzelheber
- Слеватор корневий екстракційний
- Elevadores para raices
- المعصاع الجذر

**Kopp Roots Elevator**



**DE-295**  
Kopp  
Right

**DE-296**  
Kopp  
Left

**Heber Roots Elevator**



**DE-297**  
Heber  
Bayonet

**DE-298**  
Heber  
Bayonet

**Bein Roots Elevator**



**DE-299**  
Bein,  
3mm

**DE-300**  
Bein,  
4mm

**Bein Roots Elevator**



**DE-302**  
2mm  
straight  
serrated

**DE-303**  
3mm  
straight

**DE-304**  
4mm  
Curved

**DE-306**  
2mm  
straight  
serrated

**DE-307**  
3mm  
straight

**DE-308**  
4mm  
Curved

**DE-310**  
2mm  
straight  
serrated

**DE-311**  
3mm  
straight

**DE-312**  
4mm  
Curved

**DE-301**  
Bein  
2mm, curved  
serrated

**DE-305**  
Bein  
2mm, curved  
serrated

**DE-309**  
Bein  
2mm, curved  
serrated



# ROOT ELEVATOR

- Элеватор корневой экстракционный
- Elévateurs à racines
- Wurzelheber
- Elevator corneviu extracționii
- Elevadores para raices
- المصاعد الجذر

## Seldin Roots Elevator



**DE-313** Cryer 27 (Left)   
 **DE-314** Cryer 28 (Right)   
 **DE-315** Seldin #1L   
 **DE-316** Seldin #1R   
 **DE-317** Seldin #4L   
 **DE-318** Seldin #4R   
 **DE-319** Seldin No.1 (Stout)   
 **DE-320** Seldin No.2   
 **DE-321** Kopp No.3   
 **DE-322** Kopp No.4

## W. Barry Roots Elevator



**DE-323** W. Barry 1 (mm 125)   
 **DE-324** W. Barry 1   
 **DE-325** W. Barry 2   
 **DE-326** W. Barry 3   
 **DE-327** W. Barry 4

## Winter Roots Elevator



**DE-328** Winter 1L (mm 125)   
 **DE-329** Winter 1L   
 **DE-330** Winter 1R   
 **DE-331** Winter 11L   
 **DE-332** Winter 11R   
 **DE-333** Winter 12L   
 **DE-334** Winter 12R

## Pott Roots Elevator



**DE-335** Lecluse bayonet   
 **DE-336** Pott Left   
 **DE-337** Pott Right



**ROOT ELEVATOR**

- Элеватор корневой экстракционный
- Elévateurs à racines
- Wurzelheber

- Elevator corneviu extracționiu
- Elevadores para raices
- المصاعد الجذر

**Heidbrink Roots Elevator**



**DE-338**  
Heidbrink  
Straight

**DE-339**  
Heidbrink  
Left

**DE-340**  
Heidbrink  
Right

**DE-341**  
Heidbrink  
Straight

**DE-342**  
Heidbrink  
Left

**DE-343**  
Heidbrink  
Right

**Syndesmotomes Roots Elevator**



**DE-344**  
Straight

**DE-345**  
Left

**DE-346**  
Right

**Periotome Roots Elevator**



**DE-347**  
Periotome  
2.1mm  
Straight

**DE-348**  
Periotome  
2.6mm  
Straight

**DE-349**  
Periotome  
2.1mm  
Angular

**DE-350**  
Periotome  
2mm  
Curved

**DE-351**  
Periotome  
2.0mm

**DE-352**  
Periotome  
2.5mm

**DE-353**  
Periotome  
3.0mm

**DE-354**  
Periotome  
4.0mm

Syndesmotomes



# ROOT ELEVATOR

- Элеватор корневой экстракционный
- Elévateurs à racines
- Wurzelheber
- Слеватор корневий екстракційний
- Elevadores para raices
- المصاعد الجذر



**DE-355**  
1S  
(Straight 1mm)



**DE-356**  
2S  
(Straight 2mm)



**DE-357**  
3S  
(Straight 3mm)



**DE-358**  
5S  
(Straight 5mm)



**DE-359**  
3C  
(Curved 3mm)



**DE-360**  
5C  
(Curved 5mm)



**DE-361**  
3CA  
(Curved Angle 3mm)



**DE-362**  
3IC  
(Inverted Curved 3mm)



**DE-363**  
DE 3  
(Dual Edge 3mm / 1.5mm)



**DE-364**  
DE 5  
(Dual Edge 5mm / 3mm)





**ROOT ELEVATOR**

- Элеватор корневой экстракционный
- Elévateurs à racines
- Wurzelheber
- Elevador cornevo extractivnyy
- Elevadores para raices
- المصاعد الجذر

**PDL ELEVATORS**



Distal, 2.5mm  
Micro Edge

Mesial, 2.5mm  
Micro Edge

Distal, 4mm  
Micro Edge

Mesial, 4mm  
Micro Edge

2.5mm  
Micro Edge, curved

2.5mm  
Micro Edge, Straight

3.4mm  
Straight

**DE-365**  
PDL Elevators  
Set of 7 Pcs

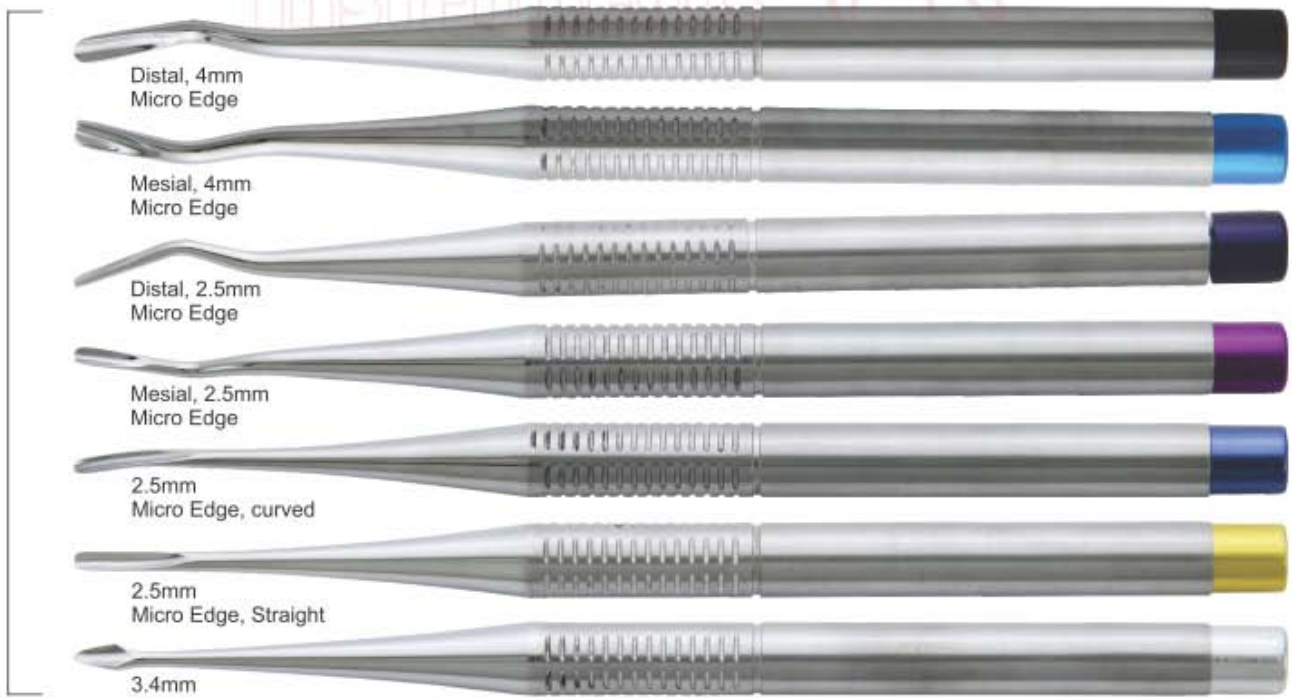

Distal, 4mm  
Micro Edge

Mesial, 4mm  
Micro Edge

Distal, 2.5mm  
Micro Edge

Mesial, 2.5mm  
Micro Edge

2.5mm  
Micro Edge, curved

2.5mm  
Micro Edge, Straight

3.4mm  
Straight

**DE-366**  
PDL Elevators  
Set of 7 Pcs

# ROOT ELEVATOR

- Элеватор корневой экстракционный
- Elévateurs à racines
- Wurzelheber
- Слеватор корневий екстракційний
- Elevadores para raices
- المصاعد الجذر

## PDL ELEVATORS

Delicate Arrow tip



4,0mm straight  
4,0mm curved

Luxivators straight  
atraumatic luxation of the tooth



2,5mm straight  
3,5mm straight  
4,5mm straight

Luxivators curved  
atraumatic luxation of the tooth



2,5mm curved  
3,5mm curved  
4,5mm curved



DE-367  
PDL Elevators  
Set of 8 Pcs



## Our Scalers

Compare our scalers and curettes with the best in the industry and you will immediately recognize we are equal in every way but one... price. Note the deep precision knurling for better tactile feel. The same high-grade stainless steel tips, the same light weight (under 18 grams) for less hand fatigue, the same professional craftsmanship, and surpassing the highest industry standards. of course, any manufacturer can make these claims, but we guarantee and certify ours.



Healthy

Periodontal Disease

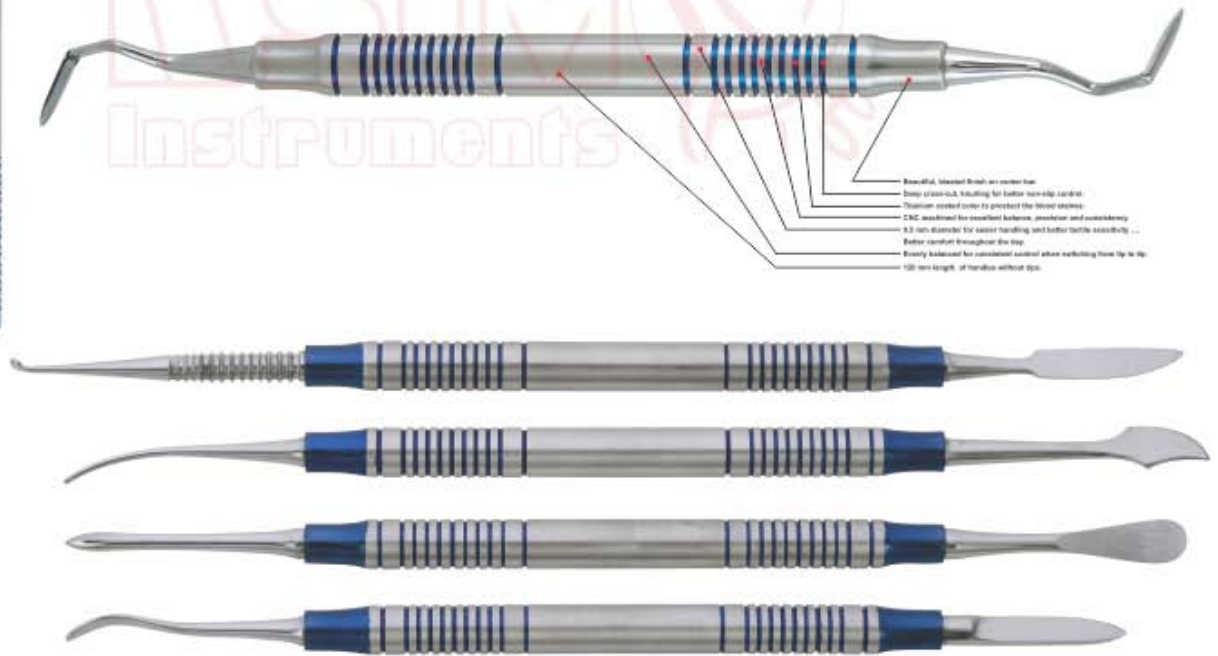
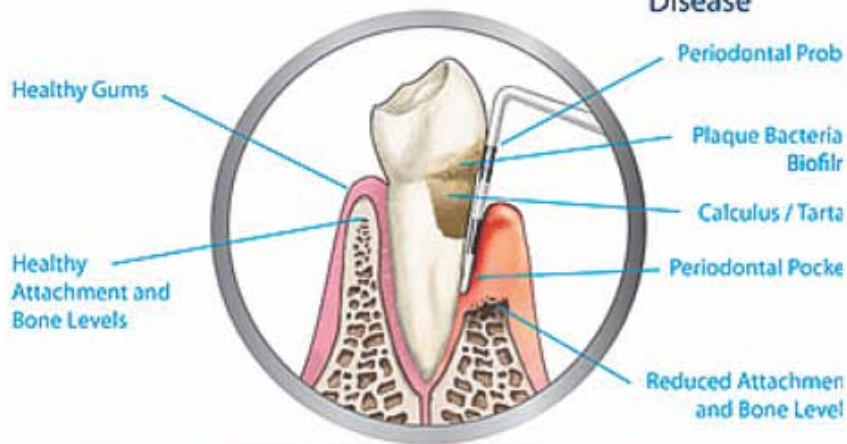

- Beautiful, blended finish on entire tool
- Deep groove-knurling for better non-slip control
- Titanium coated ends to protect the blood stream
- CNC machined for excellent balance, precision and consistency
- 2.0 mm diameter for easier handling and better tactile sensitivity ...
- Better comfort throughout the tip
- Every balanced for consistent control when working from tip to tip
- 100 mm length of handle without tips

- High-polish mirror finish tips.
- Manufactured within the guidelines of the FDA quality assurance system for good manufacturing practices.
- Highest grade German stainless steel, razor sharp, durable tips. Rockwell hardened to 60 RHc.
- 27 of the most popular designs from graceys to McCalls to cumbias, and many european patterns.
- All instruments are guaranteed against defects in material and workmanship.

- All instruments bear the ce mark, emblematic of the european community's highest standards.
- Customer satisfaction guarantee, too!
- Less than 20 grams ... Lightweight for less hand fatigue.
- Manufactured to the most exacting standards so the 50th instrument you buy is exactly like your first.
- You decide ... Why pay more for the same high-quality instruments?

# HANDLES FOR MOUTH MIRRORS

- Ручки для зеркал
  - Manches pour miroirs à bouche
  - Mundspiegelgriffe
- Ручки для дзеркал
  - Mangos para espejos de boca
  - مقابض لمرآيا الفم



Magnifying



DE-368  
Fig. 3  
Ø20 mm

DE-369  
Fig. 4  
Ø22 mm

DE-370  
Fig. 5  
Ø24 mm

Plain



DE-371  
Fig. 3  
Ø20mm

DE-372  
Fig. 4  
Ø22mm

DE-373  
Fig. 5  
Ø24mm



Rhodium

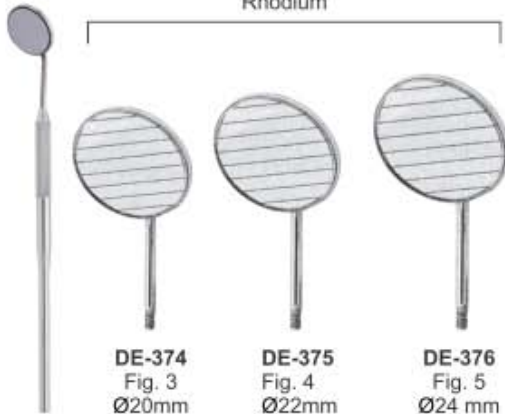

DE-374  
Fig. 3  
Ø20mm

DE-375  
Fig. 4  
Ø22mm

DE-376  
Fig. 5  
Ø24 mm

DE-377 Hollow Mirror Handle Stem Extra Light (7.5mm) Length 5"



DE-378 Mirror Handle Stem Octagonal (6mm) Length 5"



DE-379 Mirror Handle Stem Round (6mm) Length 5"



DE1-380 Solid 12cm



DE2-380 Solid



DE3-380 Mirror Handle Stem with Rule 35mm (6mm) Length 5"



DE-380 Mirror Handle Stem with Rule 35mm (6mm) Length 5"



- Пинцеты
- Pinceltes - Brucelles
- Zahnpinzetten

- Пинцети
- Pinzas para algodón
- ملاقط

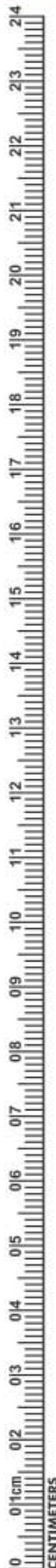

**DE-381**  
Surgical  
11.5cm



**DE-382**  
London College  
15cm



**DE-383**  
Semken Taylor  
Str.



**DE-384**  
Semken Taylor  
Cvd.



**DE-385**  
Meriam  
16cm



**DE-386**  
Dressing  
14cm



**DE-387**  
Semken Taylor  
1x2 Straight



**DE-388**  
Semken Taylor  
1x2 Curved



**DE-389**  
Gilles  
15cm 1x2



**DE-390**  
14cm 1x2



**DE-391**  
Perry  
13cm



**DE-392**  
Atraumatic  
15cm Cvd



**DE-393**  
Atraumatic  
15cm Str.



**DE-394**  
College with Lock  
15cm Cvd.



**DE-395**  
Gerald  
17.5cm



**DE-396**  
with lock  
15cm



**DE-397**  
Atraumatic  
17.5cm



**TWEEZERS**

- Пинцеты
  - Pincettes - Brucelles
  - Zahnpinzetten
- Пинцети
  - Pinzas para algodón
  - ملاقط



**DE-398**  
Adson-TC  
12cm



**DE-399**  
Adson-TC  
12cm 1x2



**DE-400**  
Adson-TC  
15cm 1x2



**DE-401**  
Adson  
12cm



**DE-402**  
Adson  
12cm 1x2



**DE-403**  
Adson  
15cm 1x2



**DE-404**  
Adson Brown  
12cm



**DE-405**  
Crane Kaplan  
15cm



**DE-406**  
Crane Kaplan  
15cm



**DE-407**  
Crane Kaplan  
15cm



**DE-408**  
Hemingway  
15cm



**DE-409**  
Miller  
15cm Str.



**DE-410**  
Miller  
15cm Cvd.



**DE-411**  
Dressing  
Tweezer  
14.5cm



**DE-412**  
College  
Curved  
Tip 15cm



**DE-413**  
Maryam  
Tweezers  
15cm



**DE-414**  
College  
Tweezer  
15cm



**DE-415**  
Perry  
Tweezer  
12.5cm



**DE-416**  
Self-locking  
Tweezer  
15cm



- Зонды
- Sondes
- Zahnsonden
- Зонди
- Sondas
- المستكشفين

Single Ended Probe Solid Handle 4.5mm Length 150mm



Fig. 2  
Normal Handle



DE-416  
Fig. 2



DE-417  
Fig. 23



DE-418  
Fig. 9



DE-419  
Fig. 16



DE-420  
Fig. 11



DE-421  
Fig. 03



DE-422  
Fig. 3A



DE-423  
Fig. 5



DE-424  
Fig. 6



DE-425  
Fig. 8A



DE-426  
Fig. 10



DE-427  
Fig. 12



DE-428  
Fig. 17



DE-429  
Fig. 17A

Single Ended Probe Hollow Handle 8.5mm Length 150mm



Fig. 2  
Anatomic Handle



DE-430  
Fig. 2



DE-431  
Fig. 23



DE-432  
Fig. 9



DE-433  
Fig. 16



DE-434  
Fig. 11



DE-435  
Fig. 03



DE-436  
Fig. 3A



DE-437  
Fig. 5



DE-438  
Fig. 6



DE-439  
Fig. 8



DE-440  
Fig. 8A



DE-441  
Fig. 10



DE-442  
Fig. 12



DE-443  
Fig. 17



DE-444  
Fig. 17A

# EXPLORERS

- Зонды
- Sondes
- Zahnsonden
- Зонди
- Sondas
- المستكشفين

Probes Single End Solid Handle 6mm, length 150mm



Probes Single Ended 6mm, length 150mm

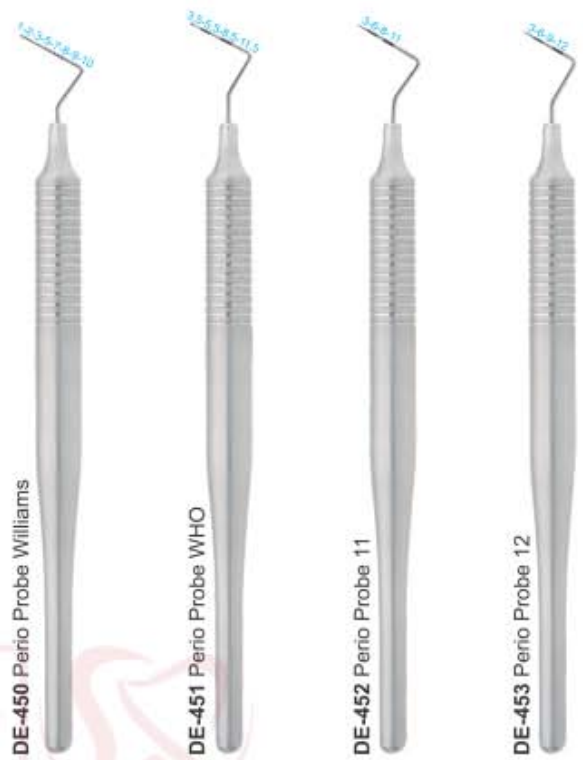

Examination kit Set of 3 Pieces



Examination Set of 4 Pieces



Examination Set of 4 Pieces





- Зонды
  - Sondes
  - Zahnsonden
- Зонди
  - Sondas
  - المستكشفين

**EXPLORERS INSTRUMENTS  
SOLID HANDLE 6MM, LENGTH 170MM**

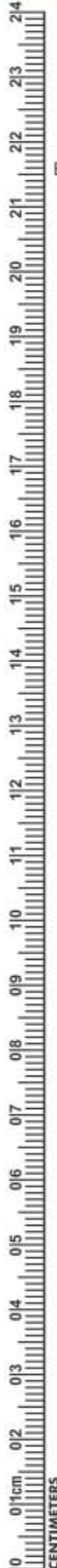

Explorers-Single-End

Double-Ended Explorers

EXPLORERS

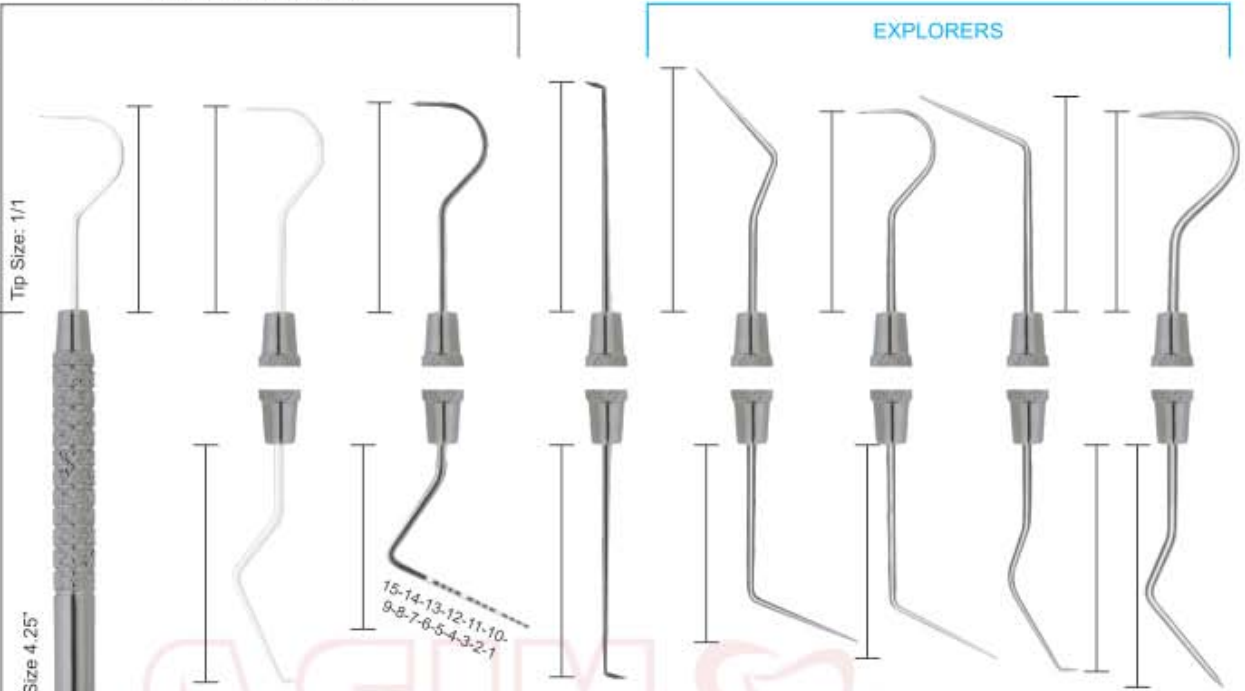

Tip Size: 1/1

Solid Handle Size 4.25"

- |  |   |                               |  |                           |                           |  |
|--|---|-------------------------------|--|---------------------------|---------------------------|--|
| <b>DE-463</b><br>TU 17/23<br>Wilkins/Tufts<br>Explorer<br>#6 | <b>DE-464</b><br>23/UNC1<br>university of north<br>carolina<br>Explorer #31, #6, #7, #8 | <b>DE-465</b><br>1<br>#31, #6 | <b>DE-466</b><br>DG 16<br>#31, #6, #7<br>Thick, #6 | <b>DE-467</b><br>DG 16/23 | <b>DE-468</b><br>DG 16/17 | <b>DE-469</b><br>1<br>Abou-Rass<br>Explorers |
|--|---|-------------------------------|--|---------------------------|---------------------------|--|

Probes Double Ended 6mm, length 170mm

**DE-461**  
23  
Shepherd's  
Hook  
Explorer  
#30, #6, #7, #8

**DE-462**  
#5, #6  
Explorer

**DE-470**  
Goldman Fox  
Fig.17

**DE-471**  
University  
of Michigan  
Fig.17

**DE-472**  
Williams  
Fig.17

**DE-473**  
Goldman Fox  
Fig.16

**DE-474**  
University  
of Michigan  
Fig.16

**DE-475**  
Williams  
Fig.16

# EXPLORERS

- Зонды
- Sondes
- Zahnsonden
- Зонди
- Sondas
- المستكشفين

Pointed Probes Single Ended Handle 6mm, length 150mm

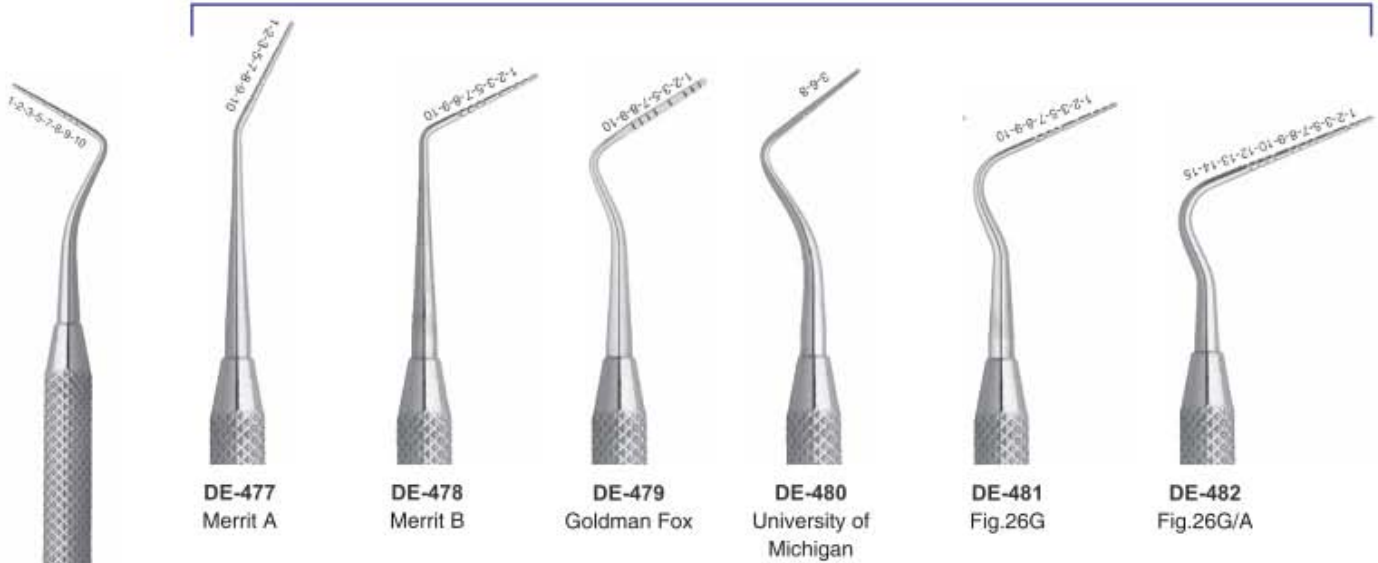

Pointed Probes Double Ended Handle 6mm, length 170mm



DE-476  
Williams



- Инструменты пародонтологические
  - Instruments pour la parodontologie
  - Instrumente für die Parodontologie
- Інструменти пародонтологічні
  - Instrumentos para periodoncia
  - الصكوك اللثة

PERIODONTAL SET OF 10 PIECES SOLID HANDLE 6MM LENGTH 170MM



# CURETTES

- Кюрети
- Curetas
- Küretten
- Кюрети
- Curette
- كرتس

## SICKLE SCALERS

Designed for the removal of supragingival calculus

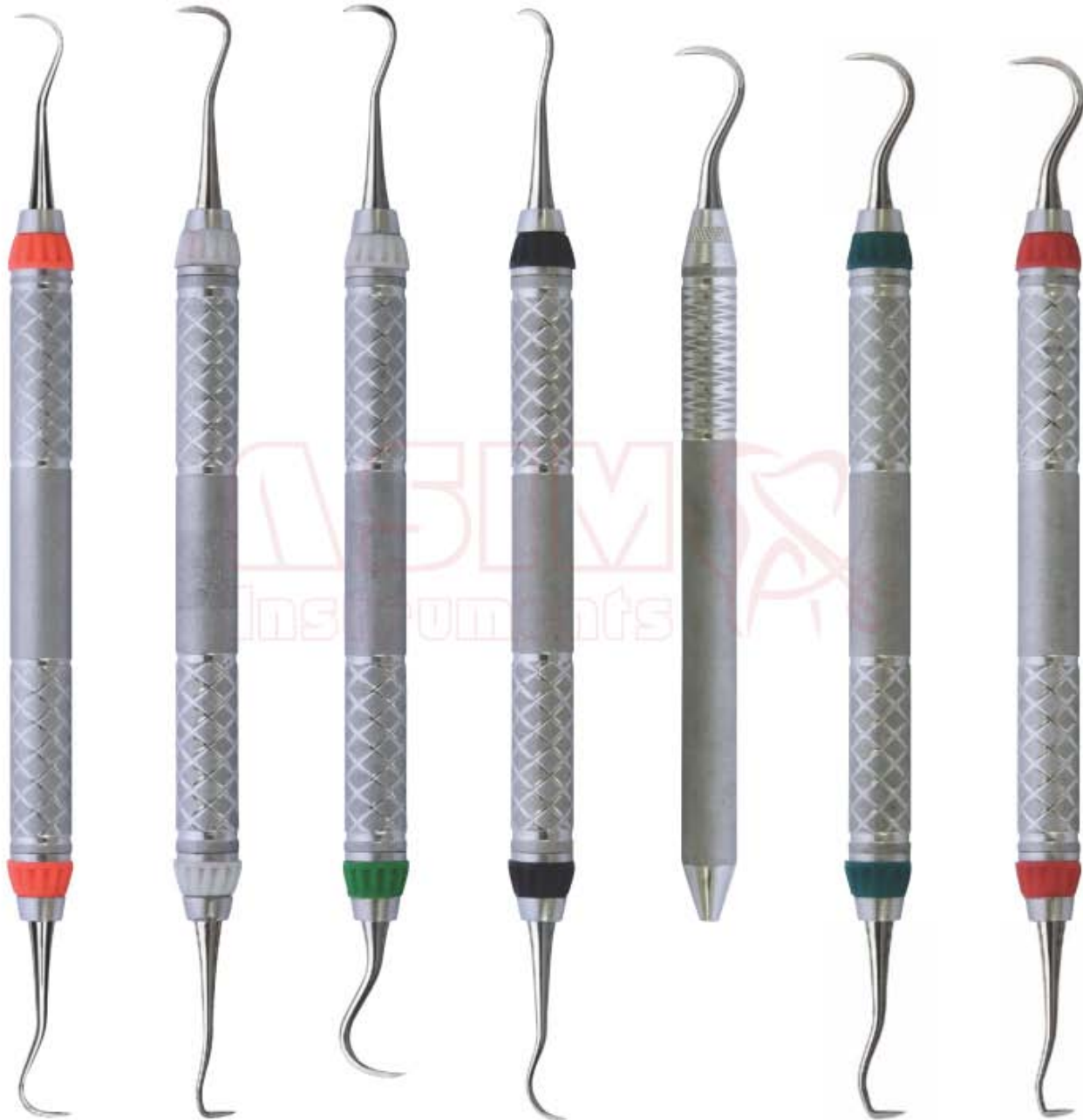

D1-001  
H6/H7  
Hygienist

D1-002  
H5/33  
Hygienist-  
Jacquette

D1-003  
H5/U15  
Hygienist-  
Towner

D1-004  
6/7  
Goldman

D1-005  
U15  
Towner

D1-006  
U15/30  
Towner-  
Jacquette

D1-007  
U15/33  
Towner-  
Jacquette



- Кюрети
- Curetas
- Küretten
- Кюрети
- Curette
- كرتس



SCALERS

JACQUETTE SCALERS

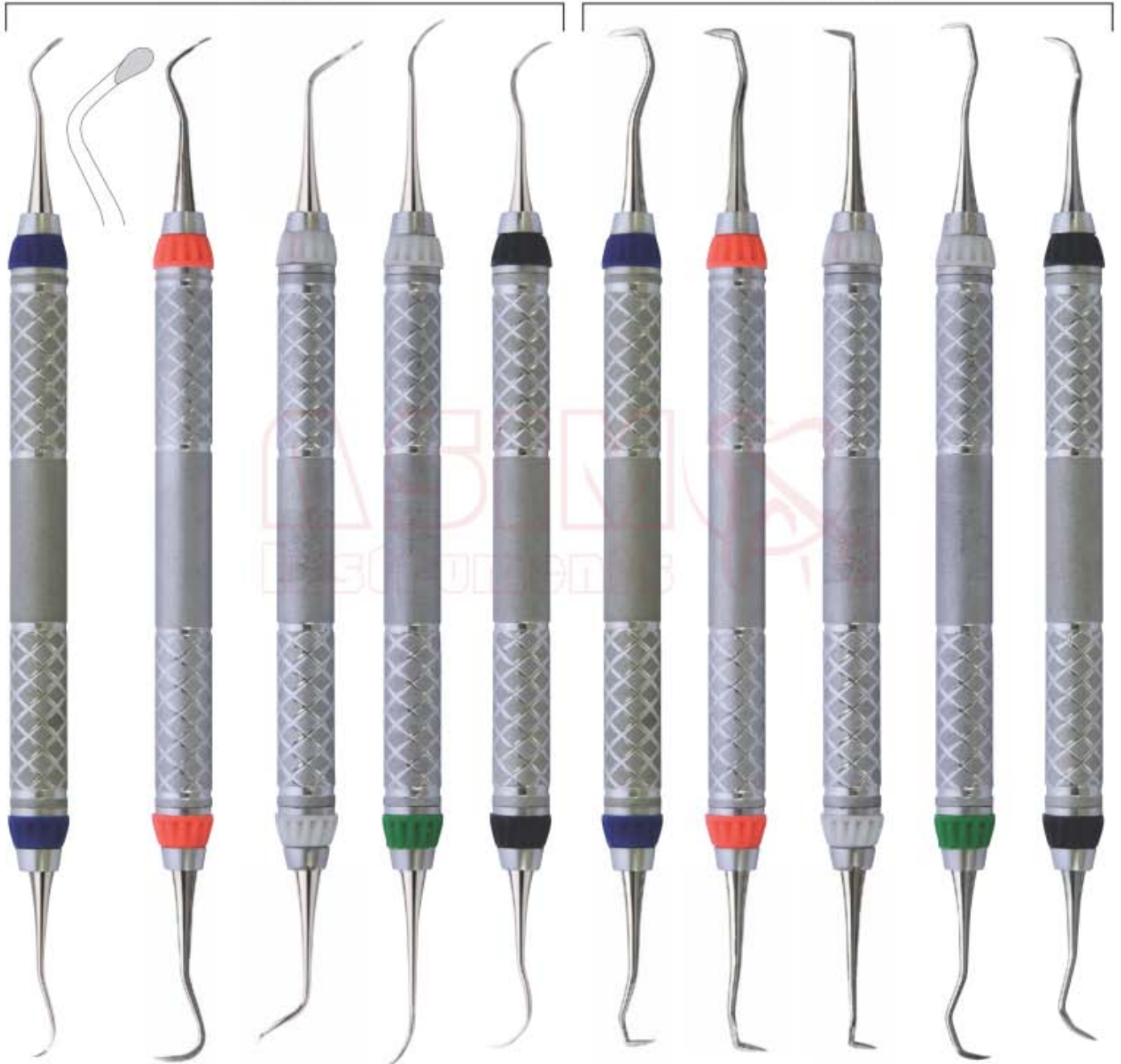

**D1-008**  
Nevi 1  
Anterior

**D1-009**  
Nevi 1/H5  
Anterior

**D1-010**  
Nevi 2  
Posterior

**D1-011**  
Nevi 3  
Posterior

**D1-012**  
Nevi 4  
Posterior

**D1-013**  
30/33  
Jacquette

**D1-014**  
31/32  
Jacquette

**D1-015**  
34/35  
Jacquette

**D1-016**  
H3/H4  
Jacquette

**D1-017**  
14/15  
Posterior

# CURETTES

- Кюрети
- Curetas
- Küretten
- Кюрети
- Curette
- كرتس

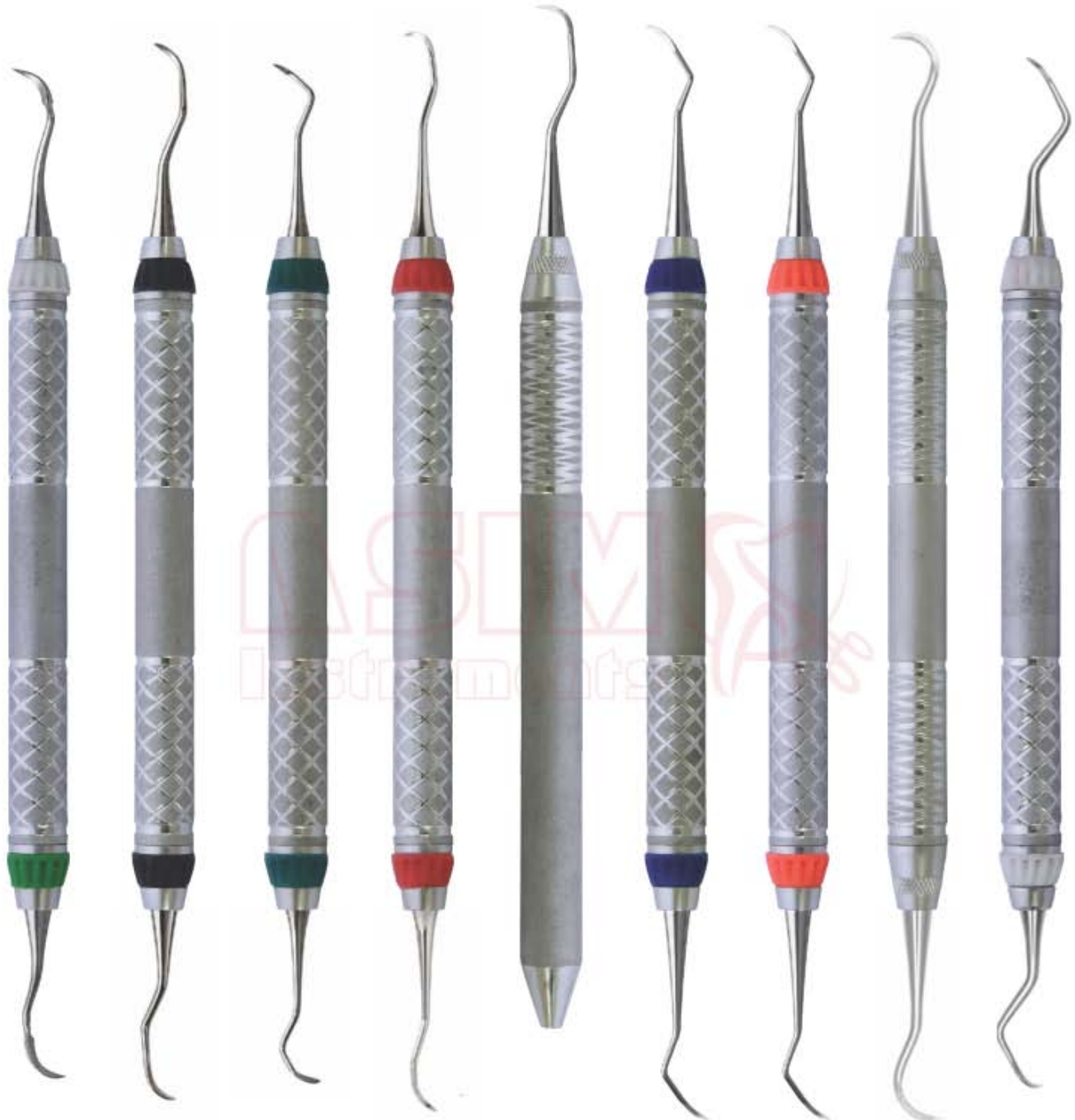

D1-018  
204

D1-019  
204  
IUFW

D1-020  
204S

D1-021  
204SD

D1-022  
1  
Springfield  
Anterior

D1-023  
2/3  
Springfield

D1-024  
2/3  
Springfield

D1-025  
J1/2  
Johnson

D1-026  
Sickel-Scaler  
Posterior



- Кюрети
- Curetas
- Küretten
- Кюрети
- Curette
- كرتس

SICKLE SCALERS

POSTERIOR

ANTERIOR



D1-027  
135



D1-028  
REM 3/4  
Remington



D1-029  
129



D1-030  
T2/T3  
Taylor



D1-031  
137



D1-032  
0/00  
Morse



# CURETTES

- Кюрети
- Curetas
- Küretten
- Кюрети
- Curette
- كرتس



D1-033  
137  
Mini Five



D1-034  
OD1/33  
Odont/  
Jacquette



D1-035  
128  
Nebraska



D1-036  
USC-128



D1-037  
WH-2  
Whiteside



D1-038  
YG-15  
Younger-  
Good





- Кюрети
- Curetas
- Küretten
- Кюрети
- Curette
- کرتس



BALL SCALERS

CRANE-KAPLAN

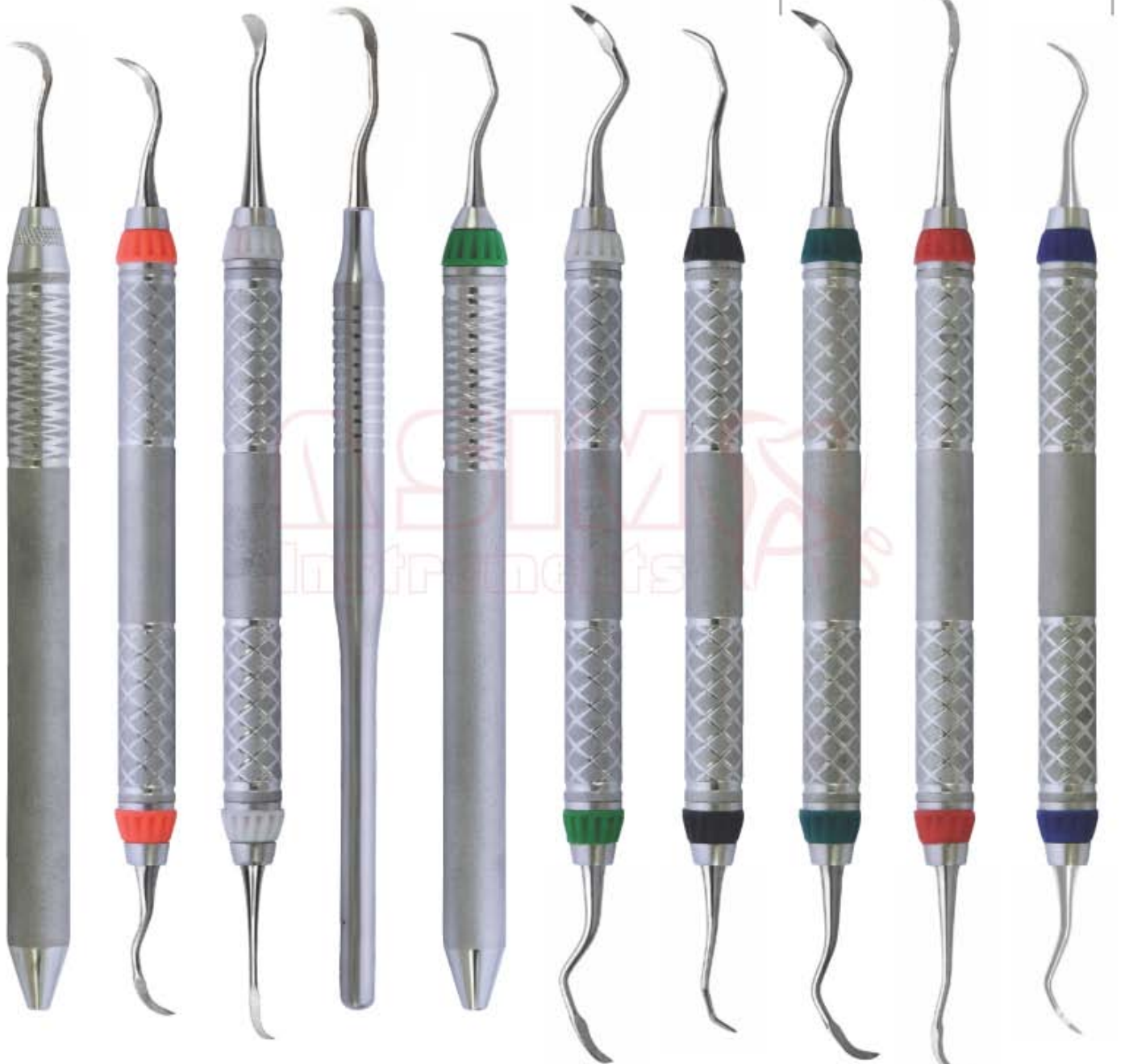

D1-039  
CI-1

D1-040  
CI-2/3

D1-041  
152  
Cumine

D1-042  
B-1

D1-043  
B-4

D1-044  
B-2/3

D1-045  
B-5/6

D1-046  
CK-6

D1-047  
CK-6D

D1-048  
333/334  
Mini Kaplan

**CURETTES**

- Кюрети
- Curetas
- Küretten
- Кюрети
- Curette
- کرتس

**SCALER / CURETTE SETS**

**Mc CALL SET**

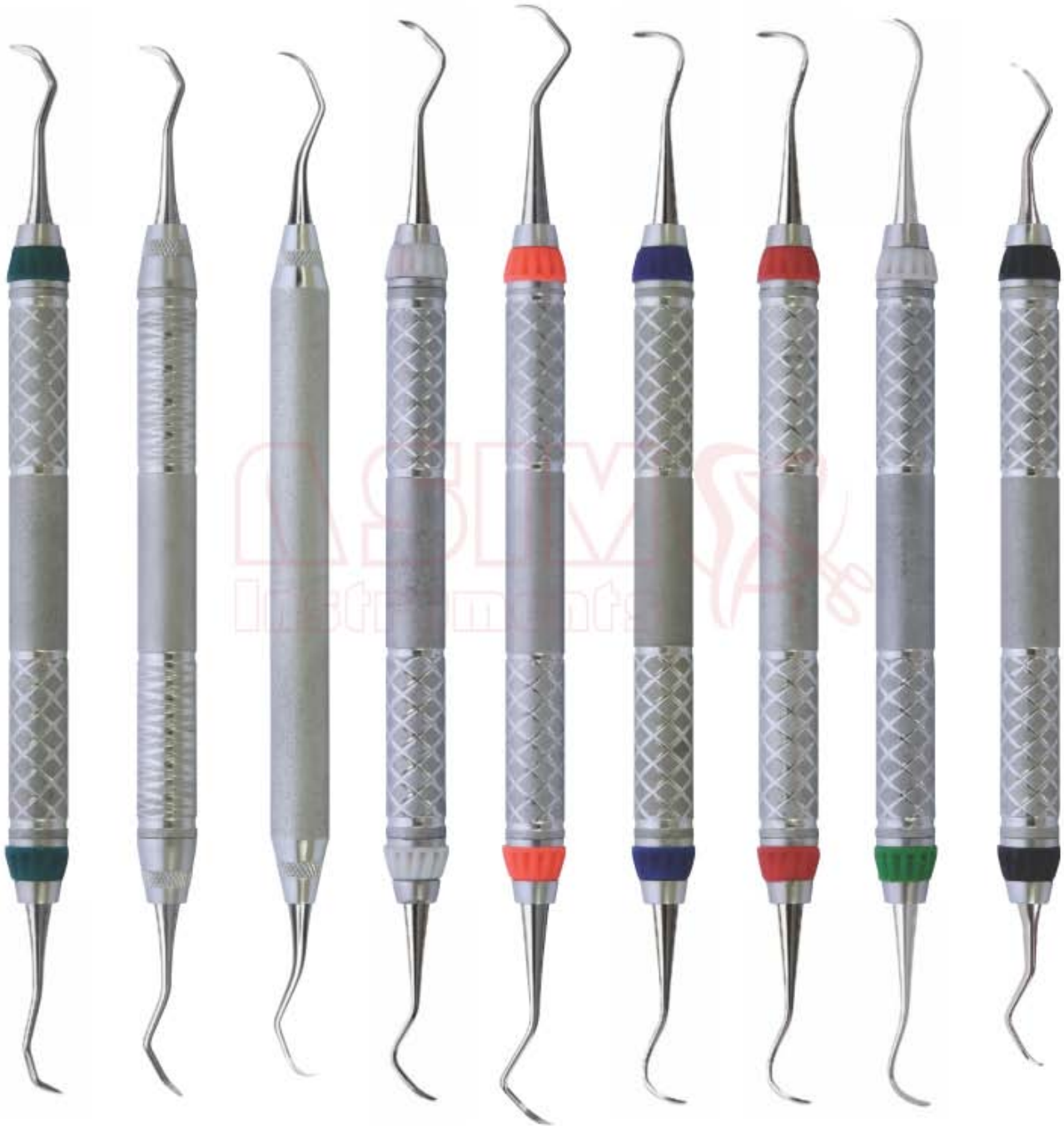

**D1-049**  
11/12  
Scaler

**D1-050**  
11A/12A  
Scaler

**D1-051**  
11/12S  
Modified  
McCall

**D1-052**  
13S/14S  
Pointed  
Curette

**D1-053**  
MTC 13/14  
Pointed  
Curette

**D1-054**  
17/18  
Curette

**D1-055**  
17S/18PT  
Curette

**D1-056**  
19/20  
Curette

**D1-057**  
Goldman-Fox



- Кюрети
- Curetas
- Küretten
- Кюрети
- Curette
- کرتس

SCALER / CURETTE SETS

GOLDMAN-FOX SET

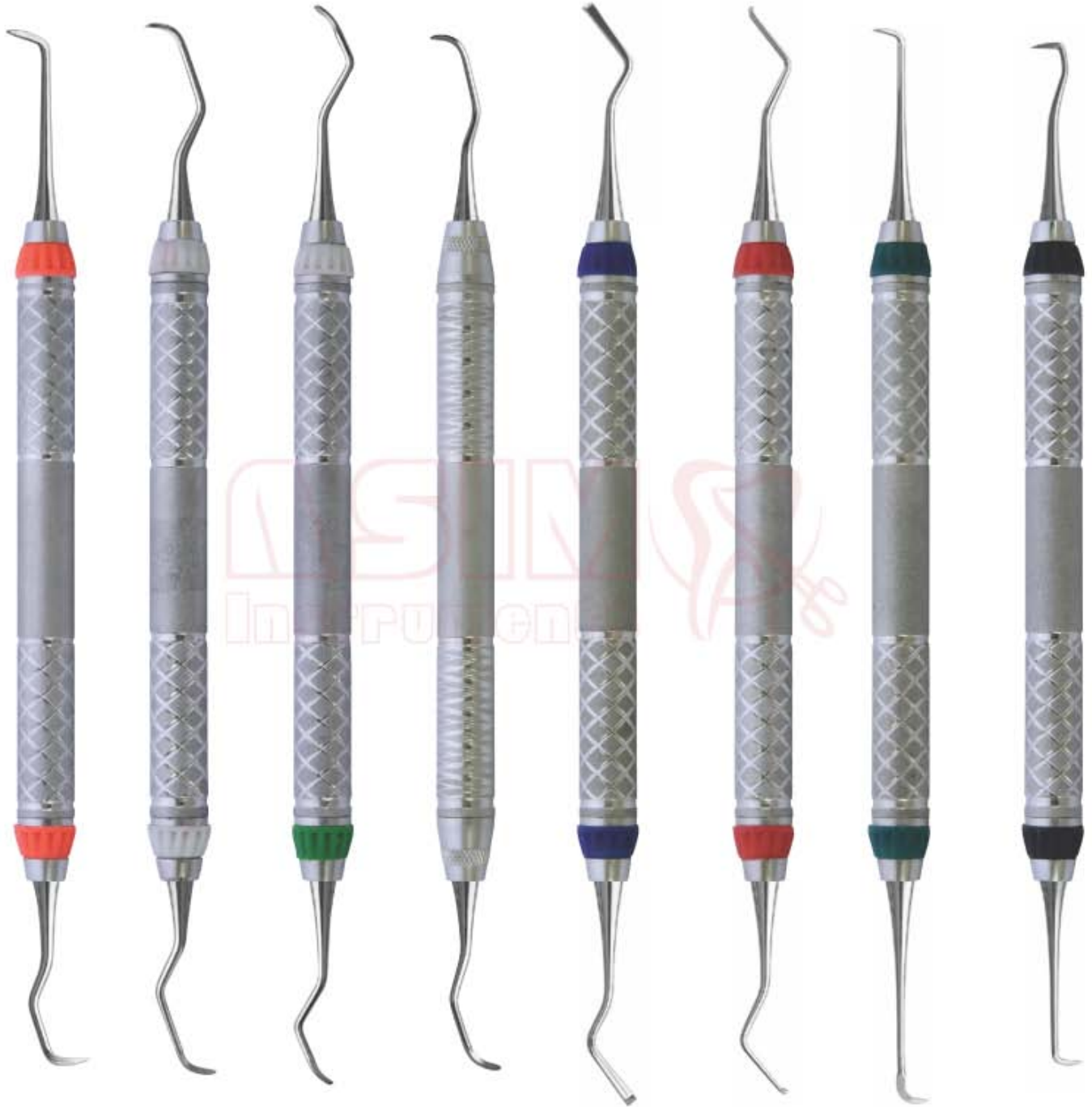

D1-058 GF-1 Universal Scaler	D1-059 GF-2 Curette	D1-060 GF-3 Curette	D1-061 GF-4 Curette	D1-062 GF-5 Hoe Buccal/Lingual	D1-063 GF-6 Hoe	D1-064 GF-21	D1-065 GF-21S/33 Combination
------------------------------------	---------------------------	---------------------------	---------------------------	--------------------------------------	-----------------------	-----------------	------------------------------------

**CURETTES**

- Кюрети
- Curetas
- Küretten
- Кюрети
- Curette
- کرتس

**SCALER / CURETTE SETS**

**GOLDMAN-FOX SET**

**CATTONI SET**

**COLUMBIA**

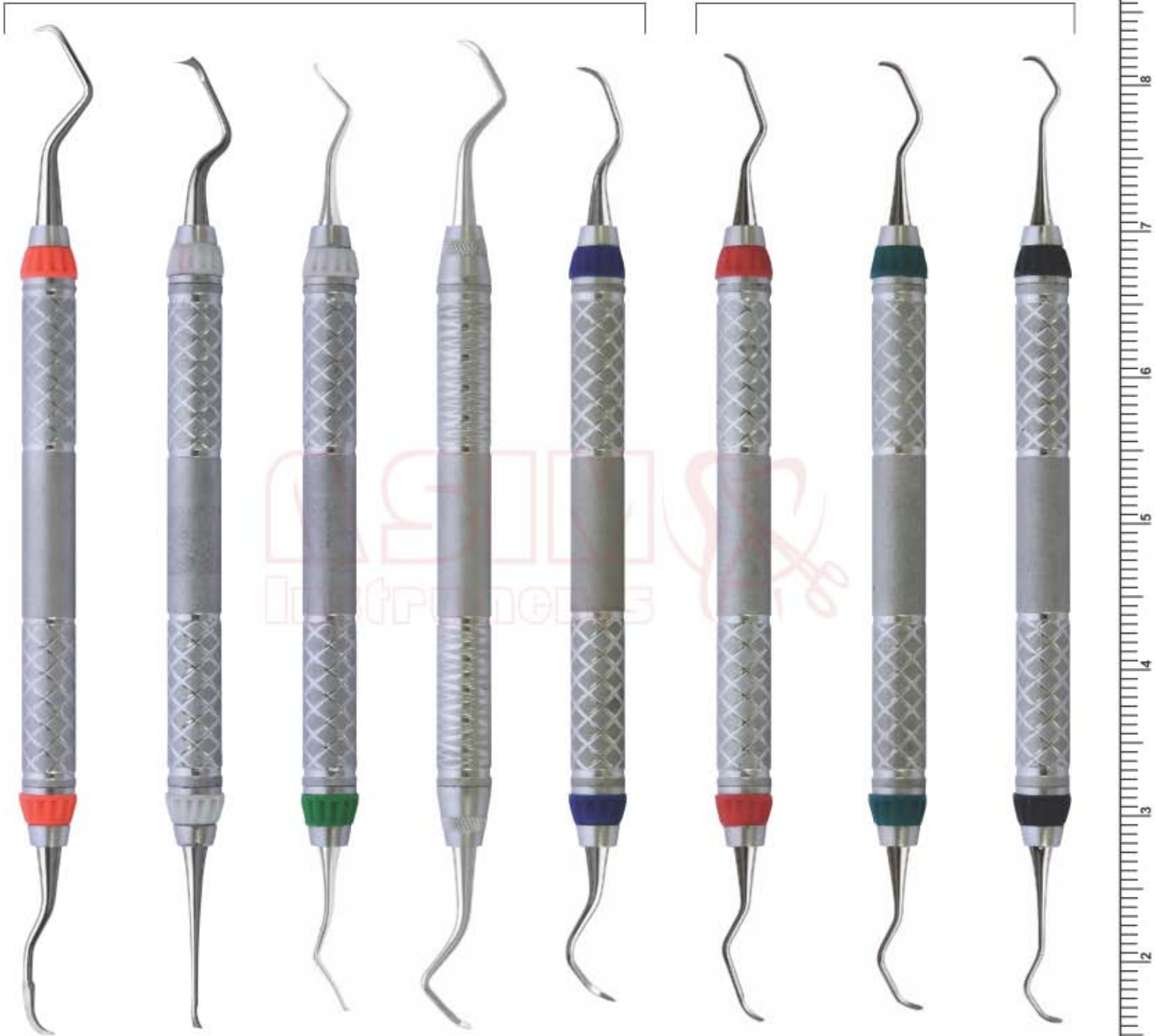

**D1-066**  
103/106

**D1-067**  
104/105  
Hoe/Chisel

**D1-068**  
112/113

**D1-069**  
107/108

**D1-070**  
107/108S  
Modified

**D1-071**  
2R/2L  
Columbia

**D1-072**  
4R/4L  
Columbia

**D1-073**  
13/14  
Columbia (shown)

**D1-074**  
13/14  
Columbia Rigid

**D1-075**  
13/14  
Columbia  
Curved Tip



- Кюрети
- Curetas
- Küretten
- Кюрети
- Curette
- كرتس

UNIVERSAL CURETTES

BARNHART

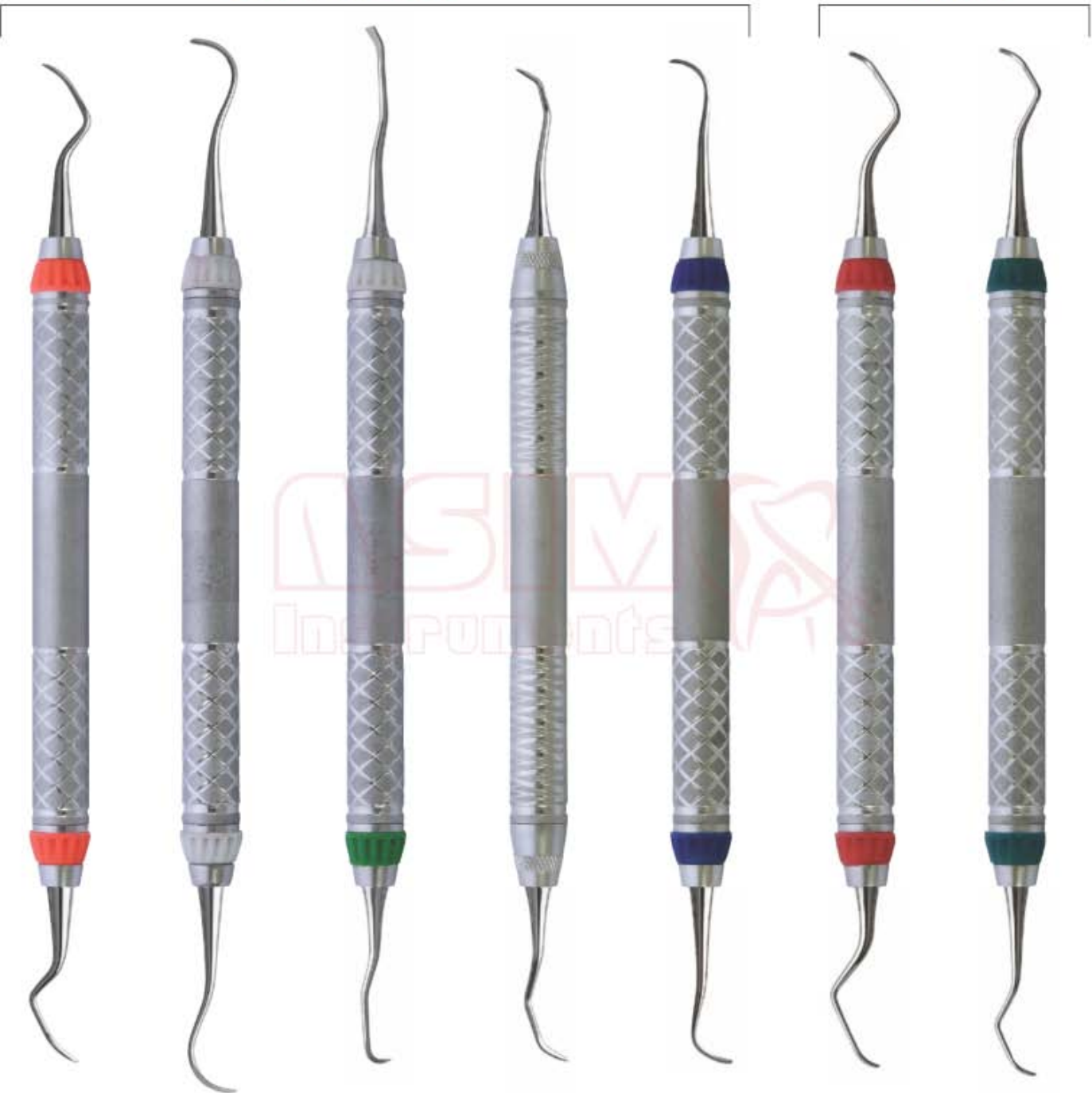

- |  |   |   |                                      |   |   |   |
|--|---|---|--------------------------------------|---|---|---|
| <p><b>D1-076</b><br/>IU13/14 Indiana University Anterior</p> | <p><b>D1-077</b><br/>IU17/18 Indiana University Posterior</p> | <p><b>D1-078</b><br/>1/2 Bunting Curette-Chisel combination</p> | <p><b>D1-079</b><br/>5/6 Bunting</p> | <p><b>D1-080</b><br/>YG7/8 Younger-Good</p> | <p><b>D1-081</b><br/>1/2 Barnhart (shown)</p> <p><b>D1-082</b><br/>1/2 Barnhart Rigid</p> | <p><b>D1-083</b><br/>5/6 Barnhart (shown)</p> <p><b>D1-084</b><br/>5/6 Barnhart Rigid</p> |
|--|---|---|--------------------------------------|---|---|---|

# CURETTES

- Кюрети
- Curetas
- Küretten
- Кюрети
- Curette
- کرتس



D1-085 1/2 (shown)      D1-086 1/2 Rigid



D1-087 3/4 (shown)      D1-088 3/4 Rigid



D1-089 5/6 (shown)      D1-090 5/6 Rigid      D1-091 5/6 Extra Rigid



D1-092 7/8 (shown)      D1-093 7/8 Rigid      D1-094 7/8 Extra Rigid



GRACEY 1/2



GRACEY 7/8



GRACEY 11/12



GRACEY 13/14



GRACEY 15/16



GRACEY 17/18



D1-095 9/10 (shown)      D1-096 9/10 Rigid



D1-097 11/12 (shown)      D1-098 11/12 Rigid      D1-099 11/12 Extra Rigid



D1-100 13/14 (shown)      D1-101 13/14 Rigid      D1-102 13/14 Extra Rigid



D1-103 15/16 (shown)      D1-104 15/16 Rigid



D1-105 17/18 (shown)      D1-106 17/18 Rigid



- Кюрети
- Curetas
- Küretten
- Кюрети
- Curette
- كرتس

GRACEY CURETTES

MICRO MINI

GRACEY PROPHY CURETTES

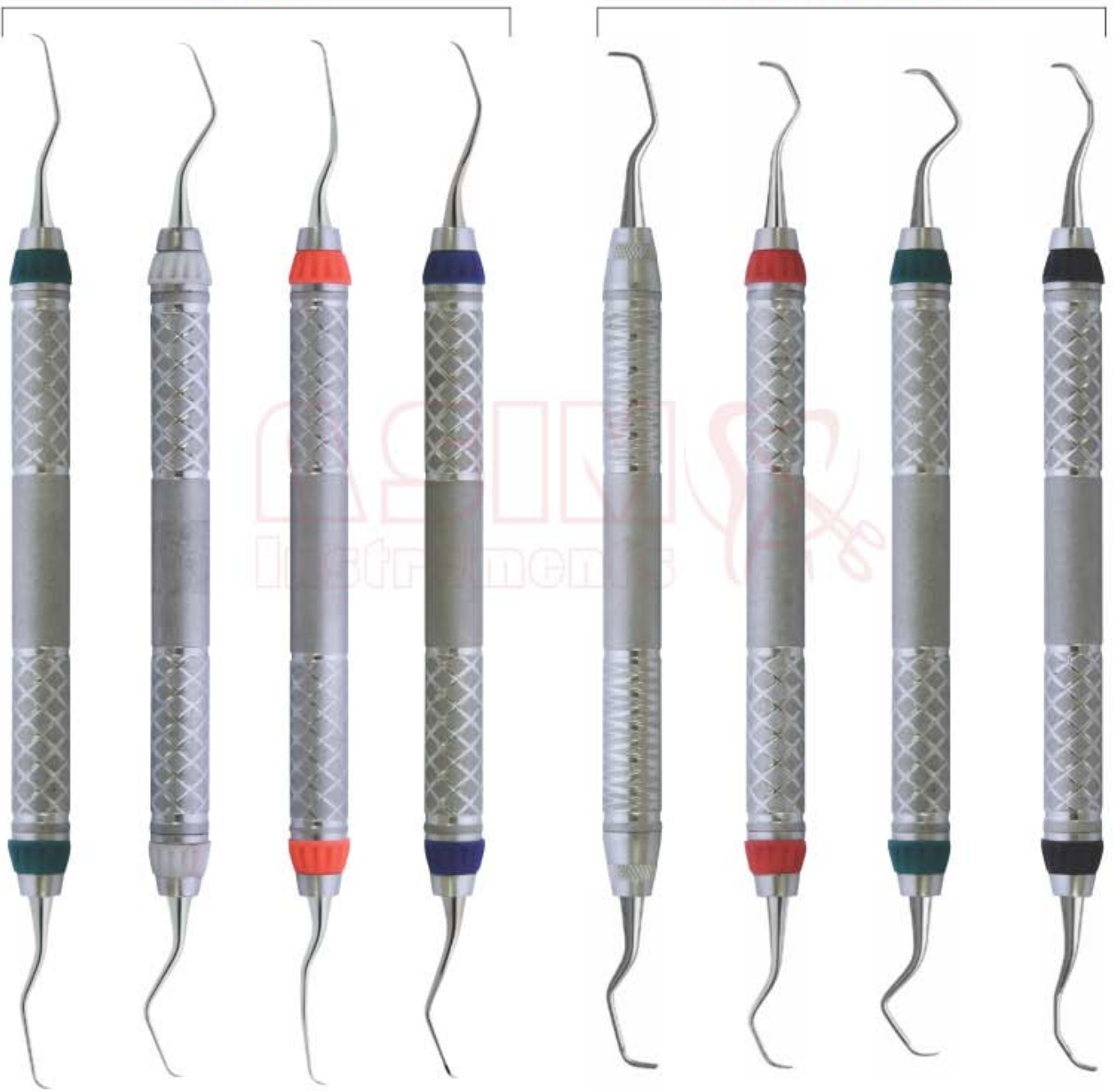

**D1-107**  
Micro Mini  
Five 1/2

**D1-108**  
Micro Mini  
Five 7/8

**D1-109**  
Micro Mini  
Five 11/12

**D1-110**  
Micro Mini  
Five 13/14

**D1-111**  
P1/2

**D1-112**  
P3/4

**D1-113**  
P5/6

**D1-114**  
P7/8

# EXPLORERS

- Зонды
- Sondes
- Zahnsonden
- Зонди
- Sondas
- المستكشفين

WILLIAM PROBE SET DOUBLE ENDED WITH HOLLOW HANDLE 9.5MM, LENGTH 170MM  
 CERAMIC COATED HANDLE

Proper care must be given during cleaning, sharpening and sterilization to preserve design and integrity and to prolong usefulness. Do not expose instruments to sterilization temperatures above 350 F/177 C or to higher than recommended chemical concentrations.

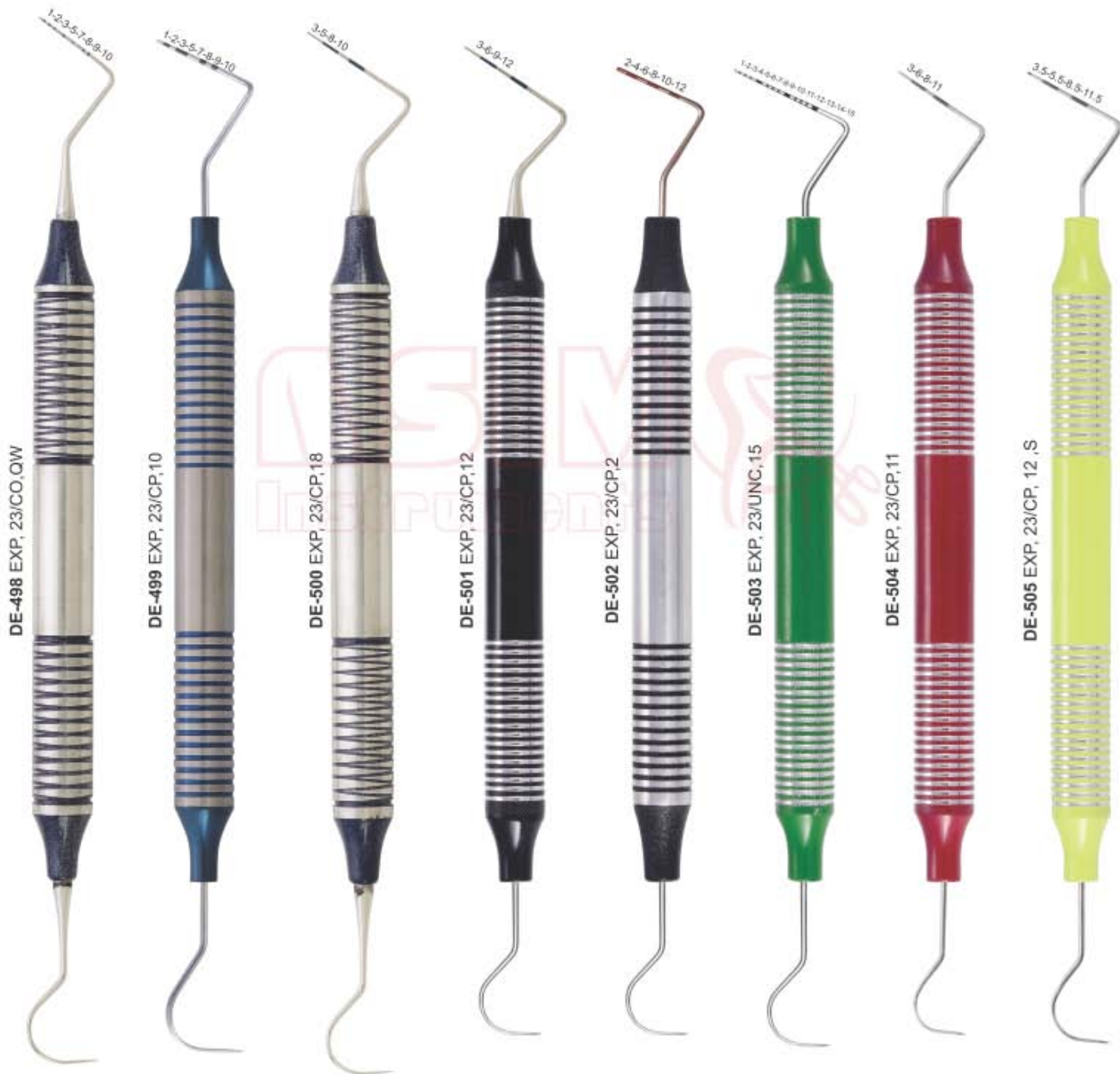



- Инструменты пародонтологические
- Instruments pour la parodontologie
- Instrumente für die Parodontologie

- Інструменти пародонтологічні
- Instrumentos para periodoncia
- الصكوك اللثة

**PERIODONTAL INSTRUMENTS SET OF 11 PCS  
SOLID HANDLE 6MM, LENGTH 170MM**

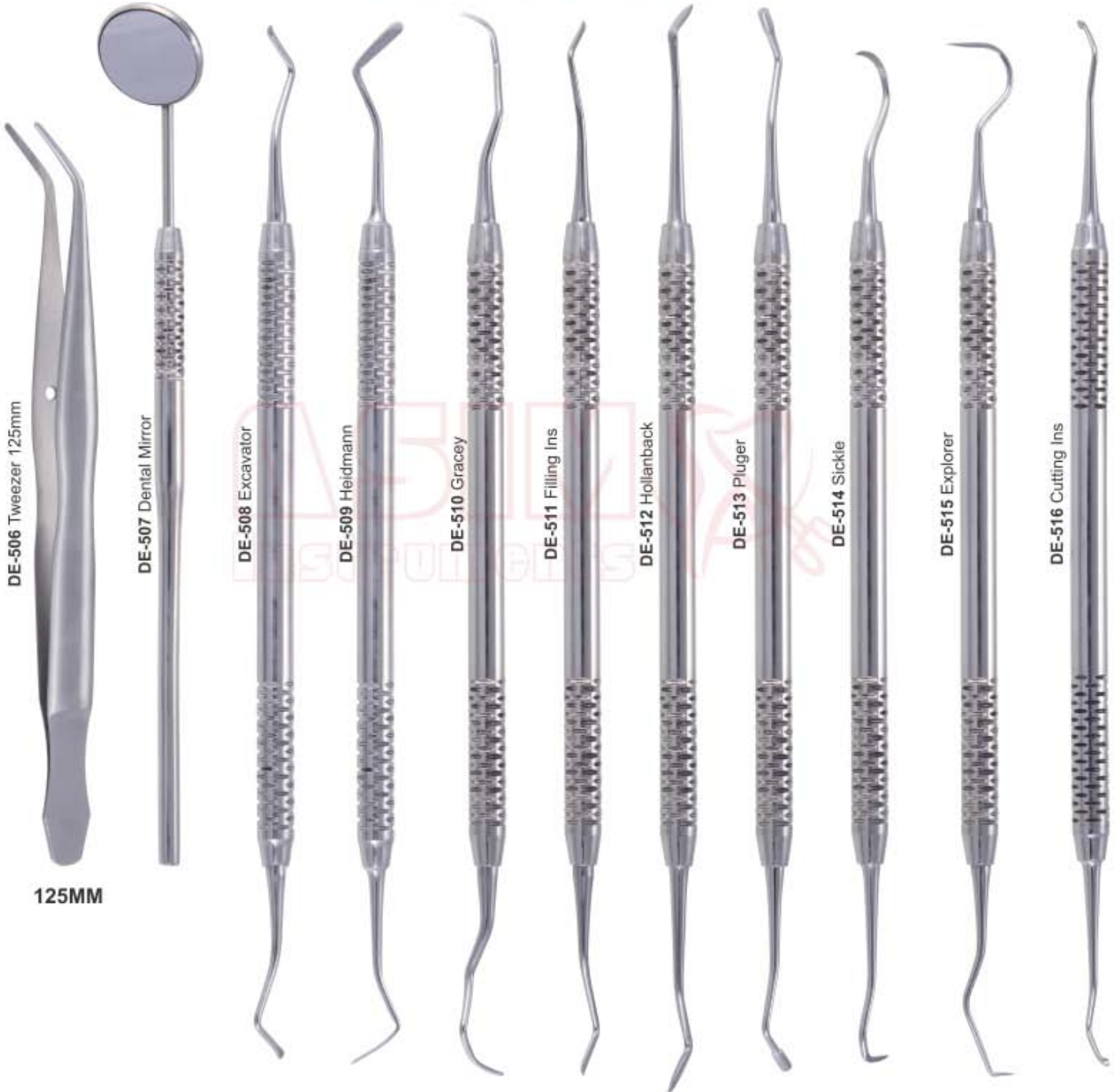

125MM

# CURETTES

- Кюрети
- Curetas
- Küretten
- Кюрети
- Curette
- كرتس

GRACEY SET OF 7 PCS HOLLOW HANDLE 9.5MM, LENGTH 170MM



DE-517  
GRACEY  
1/2

DE-518  
GRACEY  
3/4

DE-519  
GRACEY  
5/6

DE-520  
GRACEY  
7/8

DE-521  
GRACEY  
9/10

DE-522  
GRACEY  
11/12

DE-523  
GRACEY  
13/14



- Кюрети
- Curetas
- Küretten
- Кюрети
- Curette
- كرتس

**GRACEY SET OF 7 PCS**  
**HOLLOW HANDLE 9.5MM, LENGTH 170MM WITH SILICON GRIP**

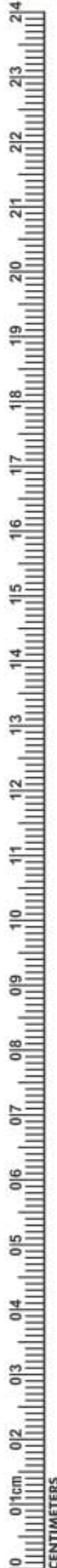

**DE-524**  
 GRACEY  
 1/2

**DE-525**  
 GRACEY  
 3/4

**DE-526**  
 GRACEY  
 5/6

**DE-527**  
 GRACEY  
 7/8

**DE-528**  
 GRACEY  
 9/10

**DE-529**  
 GRACEY  
 11/12

**DE-530**  
 GRACEY  
 13/14

**CURETTES**

- Кюрети
- Curetas
- Küretten
- Кюрети
- Curette
- كرتس

**GRACEY MINI FIVE**

HOLLOW HANDLE 9.5MM, LENGTH 170MM  
CERAMIC COATED HANDLE



<b>DE-531</b> Gracey 1/2	<b>DE-532</b> Gracey 3/4	<b>DE-533</b> Gracey 5/6	<b>DE-534</b> Gracey 7/8	<b>DE-535</b> Gracey 11/12	<b>DE-536</b> Gracey 13/14
--------------------------------	--------------------------------	--------------------------------	--------------------------------	----------------------------------	----------------------------------

**GRACEY AFTER FIVE**

HOLLOW HANDLE 9.5MM, LENGTH 170MM  
CERAMIC COATED HANDLE



<b>DE-537</b> Gracey 1/2 AF	<b>DE-538</b> Gracey 3/4 AF	<b>DE-539</b> Gracey 5/6 AF	<b>DE-540</b> Gracey 7/8 AF	<b>DE-541</b> Gracey 11/12 AF	<b>DE-542</b> Gracey 13/14 AF
-----------------------------------	-----------------------------------	-----------------------------------	-----------------------------------	-------------------------------------	-------------------------------------

Proper care must be given during cleaning, sharpening and sterilization to preserve design and integrity and to prolong usefulness. Do not expose instruments to sterilization temperatures above 350 F/177 C or to higher than recommended chemical concentrations.



- Кюрети
  - Curetas
  - Küretten
- Кюрети
  - Curette
  - كرتس

**GRACEY CURETTE  
HOLLOW HANDLE 10MM, LENGTH 170MM**

Curetters Set of 8 Pieces

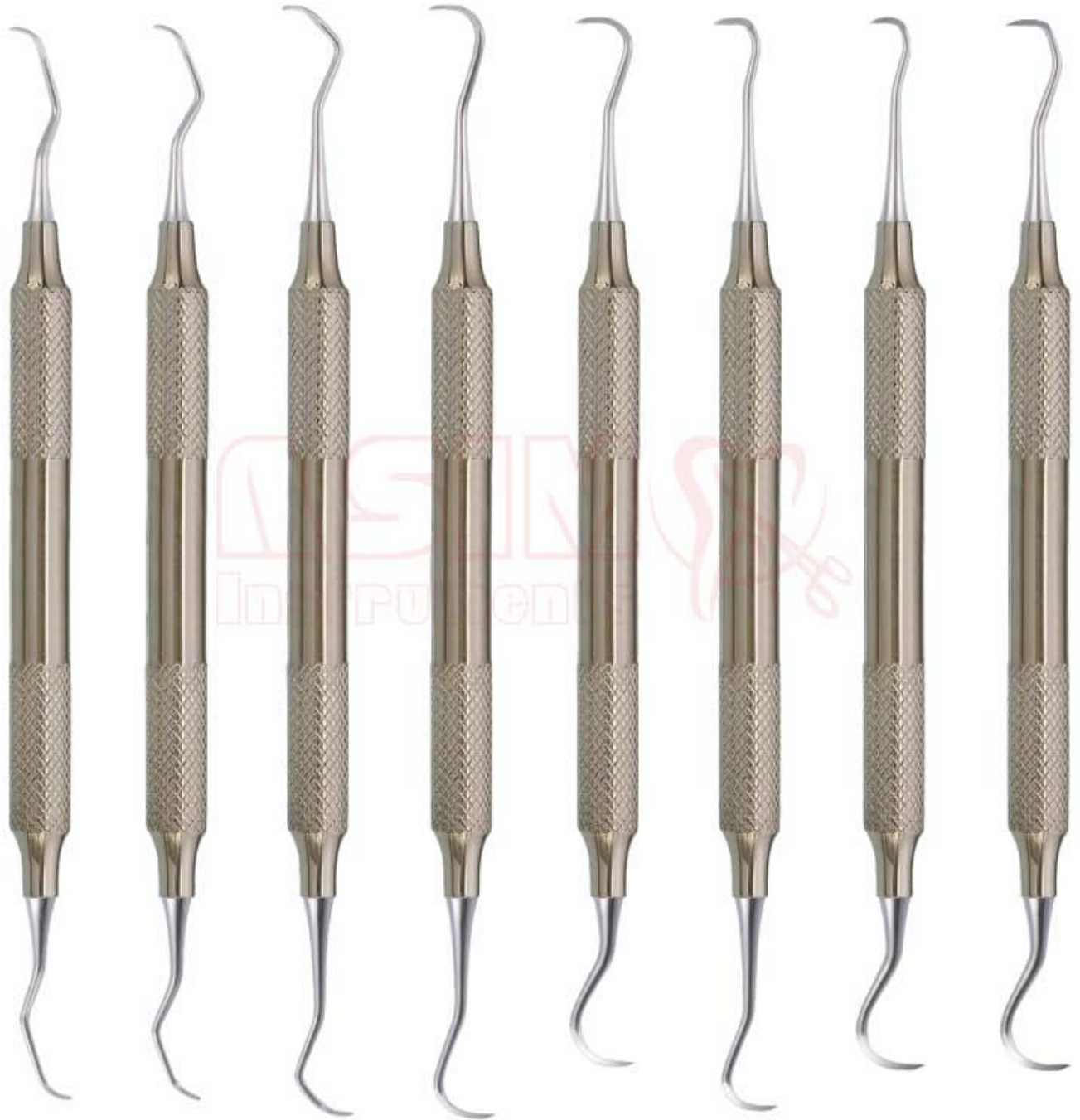

**DE-543**  
Curette  
Columbia  
2L-2R

**DE-544**  
Curette  
Columbia  
4L-4R

**DE-545**  
Curette  
McCall  
13S-14S

**DE-546**  
H6-H7  
Scaler  
Sickle

**DE-547**  
H5-U15  
Scaler  
Sickle

**DE-548**  
H5-13  
Scaler  
Sickle

**DE-549**  
U15-30  
Scaler  
Sickle

**DE-550**  
U15-33  
Scaler  
Sickle

CENTIMETERS

**FILLING INSTRUMENTS**

- Инструменты для реставрации
- Instruments pour plombage
- Füllungsinstrumente (mit Kontrawinkel)
- Инструменти для реставрації
- Instrumentos para obturaciones
- ملء الصكوك

**FILLING INSTRUMENTS (Gold Pointed)  
SOLID HANDLE 6MM, LENGTH 170MM**



**Filling instrument, spatula 6 mm solid handle, length 170 mm,**

**Filling instrument 6 mm length 175 mm,**

**Filling instrument, ball 6 mm length 170 mm,**

**Filling instrument, ball / spatula 6 mm length 175 mm,**

**Filling instrument, plan / plan 6 mm length 165 mm,**

**EXPLORERS INSTRUMENTS  
SOLID HANDLE 6MM, LENGTH 170MM**

- Зонды
  - Sondes
  - Zahnsonden
- Зонди
  - Sondas
  - المستكشفين



**PLUGGERS**

 .50 <b>DE-562</b> 5/7 21mm	 1.00 <b>DE-563</b> 9/11 21mm	 .50 <b>DE-564</b> 1/2 Root Canal Plugger	 .80 <b>DE-565</b> 3/4 Root Canal Plugger
 .45 <b>DE-561</b> 1/3 21mm	 .75 <b>DE-566</b> MA57 27mm	 1.15 <b>DE-567</b> GP3 30mm	 .20 <b>DE-568</b> ISO Size 30 24mm
 .30 <b>DE-569</b> ISO Size 40 24mm	 .40 <b>DE-570</b> ISO Size 50 24mm	 .50 <b>DE-571</b> ISO Size 60 24mm	 .25 <b>DE-565</b> 3/4 Root Canal Plugger

# PERIODONTAL PROBES

- Зонды пародонтологические
- Sondes parodontales
- sonda parodontali
- зонди пародонтологічні
- Sondas parodontales
- المسابر اللثة

## SPREADERS

## HEAT CARRIERS

Tip Size: 1/1

Solid Handle Size 4.25"

Instrument	Tip Size	ISO / Model	Length
DE-572	ISO Size 30	ISO	24mm
DE-573	.30	ISO Size 40	24mm
DE-574	.40	ISO Size 50	28mm
DE-575	.50	ISO Size 60	28mm
DE-576	.25	GP1	20mm
DE-577	.30	1S Wakai	22mm
DE-578	.40	2S Wakai	22mm
DE-579	.40	D11 Standard	23mm
DE-580	.35	D11S Thin	23mm
DE-581	.23	D11T Thinner	22mm
DE-582	.20	D11TS Thinnest	21mm
DE-583	.35	3	28mm
DE-584	.25	GP2	25mm
DE-585	.35	0‡	25mm
DE-586	.55	00‡	25mm





- Зонды пародонтологические
  - Sondes parodontales
  - sonda parodontali
- зонди пародонтологічні
  - Sondas parodontales
  - المسابر اللثة

ENDODONTICS INSTRUMENTS

ANTERIOR



**DE-587**  
8A  
29mm

**DE-588**  
8 1/2A  
29mm

**DE-589**  
9A  
29mm

**DE-590**  
9 1/2A  
29mm

**DE-591**  
10A  
29mm

**DE-592**  
10 1/2A  
29mm

**DE-593**  
11A  
29mm

**DE-594**  
11 1/2A  
29mm

**DE-595**  
12A  
29mm

LUKS



**DE-596**  
L1  
18mm

**DE-597**  
L2  
18mm

**DE-598**  
L3  
18mm

**DE-599**  
L4  
18mm

# PERIODONTAL PROBES

- Зонды пародонтологические
- Sondes parodontales
- sonda parodontali
- зонди пародонтологічні
- Sondas parodontales
- المسابر اللثة

**ENDODONTICS INSTRUMENTS SOLID HANDLE 6MM, LENGTH 170MM**

**POSTERIOR**

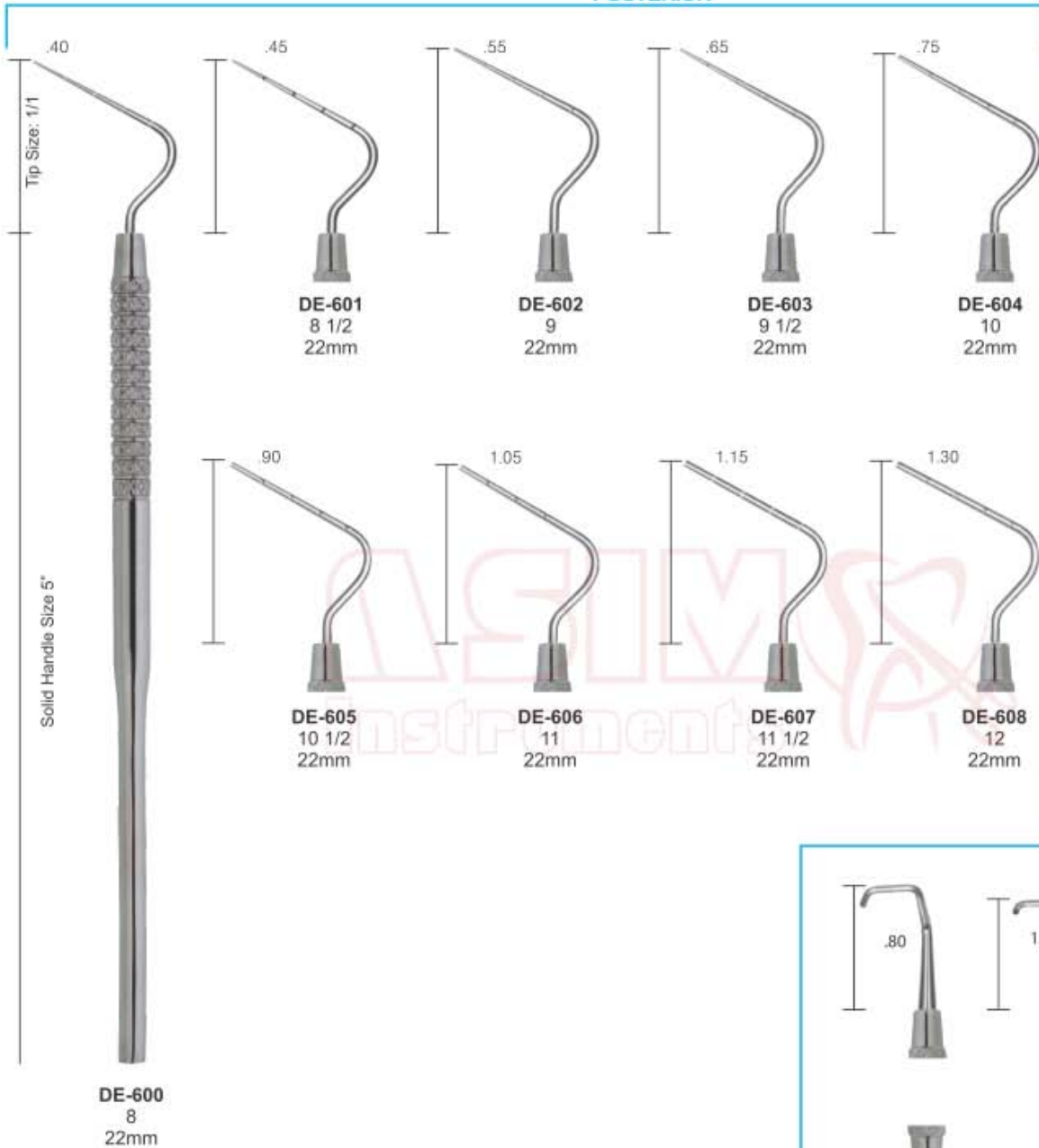

**RETRO FILLING PLUGGERS**

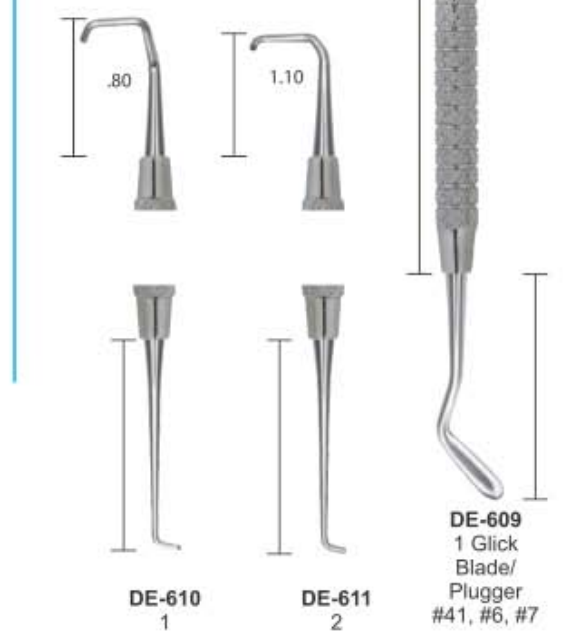

FILLING INSTRUMENTS

- Инструменты для реставрации
- Instruments pour plombage
- Füllungsinstrumente (mit Kontrawinkel)
- Инструменти для реставрації
- Instrumentos para obturaciones
- ملء الصكوك

COMPOSITE/PLASTIC FILLING INSTRUMENTS SOLID HANDLE 6MM, LENGTH 170MM

POSTERIOR

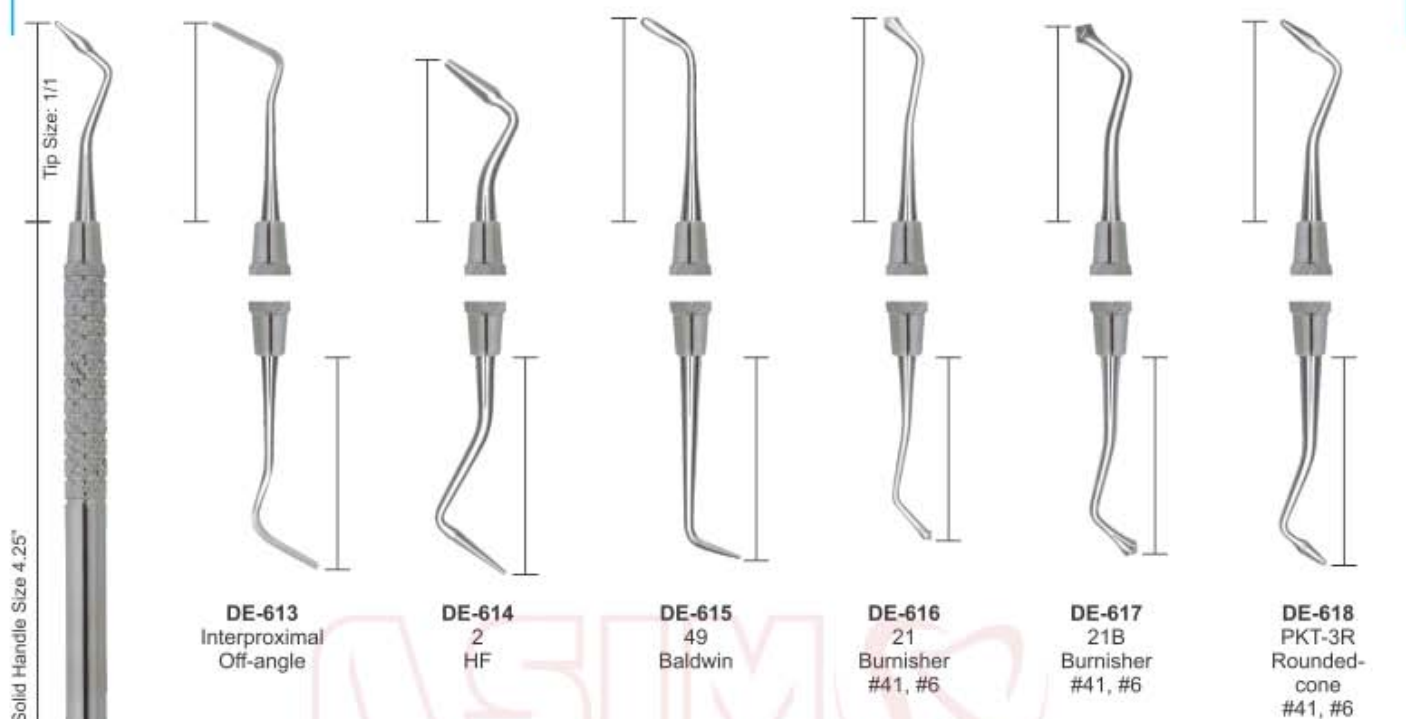
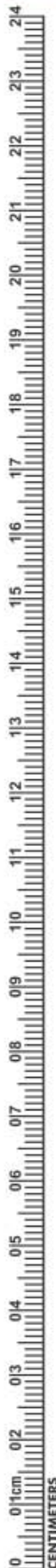

UNIVERSAL FILLING INSTRUMENTS

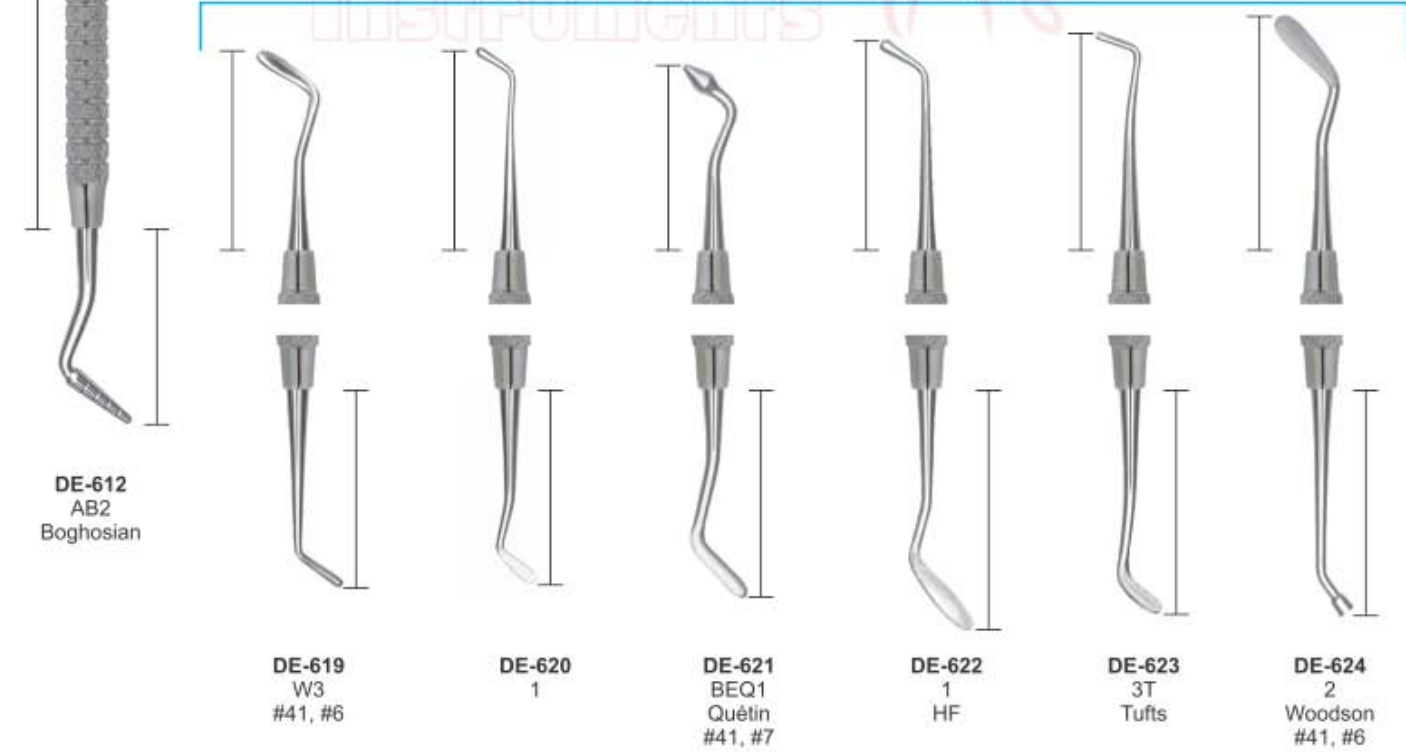

# FILLING INSTRUMENTS

- Инструменты для реставрации
- Instruments pour plombage
- Füllungsinstrumente (mit Kontrawinkel)
- Инструменти для реставрації
- Instrumentos para obturaciones
- ملء الصكوك

COMPOSITE/PLASTIC FILLING INSTRUMENTS SOLID HANDLE 6MM, LENGTH 170MM

BLACK

PLUGGERS/CONDENSERS

Hollenback

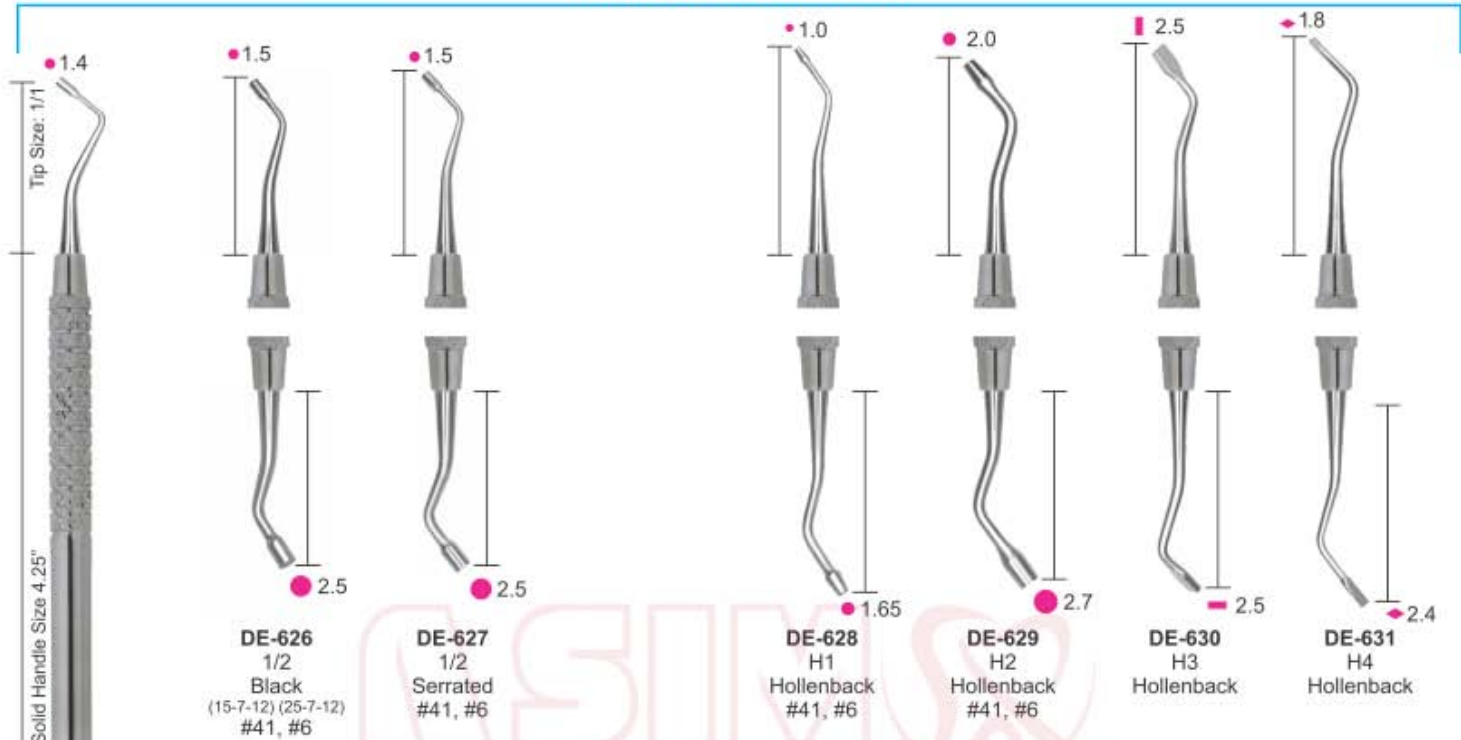

MARQUETTE CONDENSER

MORTONSON

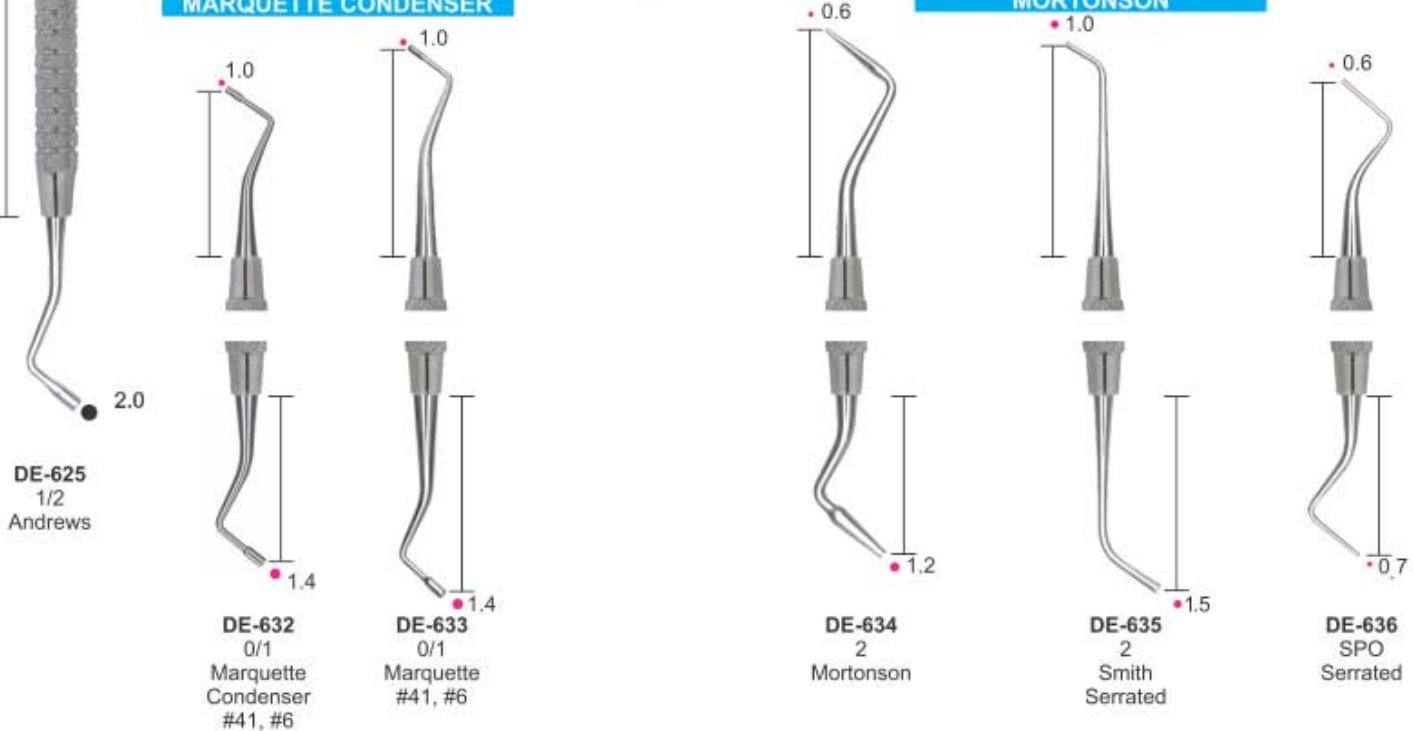

- Инструменты для реставрации
  - Instruments pour plombage
  - Füllungsinstrumente (mit Kontrawinkel)
- Инструменти для реставрації
  - Instrumentos para obturaciones
  - ملء الصكوك

PLUGGERS/CONDENSERS

RESTORATIVE INSTRUMENTS SOLID HANDLE 6MM, LENGTH 170MM

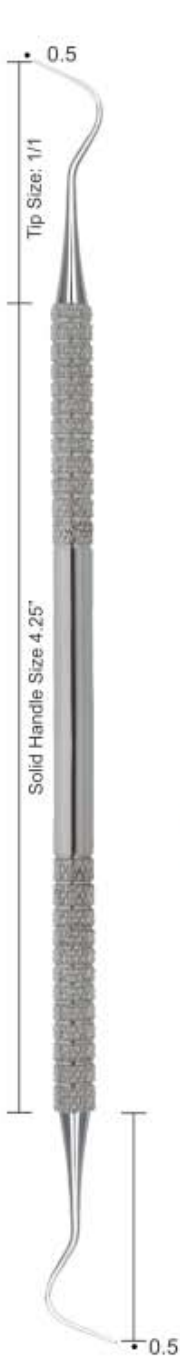

DE-637  
1M  
Markley



DE-638  
2M  
Markley



DE-639  
4M  
Markley

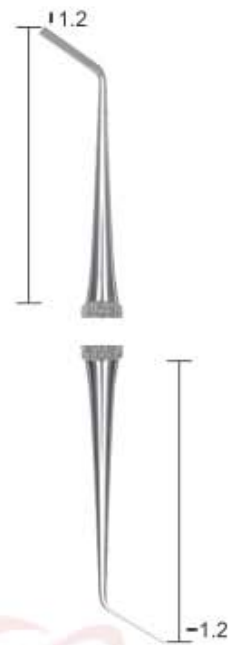

DE-640  
5M  
Markley

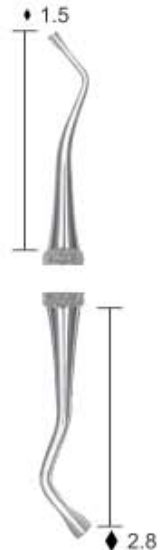

DE-641  
6M  
Markley

PLUGGERS/CONDENSERS



DE-642  
1  
Oregon  
#41, #6



DE-643  
2  
Oregon  
#41, #6



DE-644  
3  
Oregon



DE-645  
4  
Oregon  
#41, #6

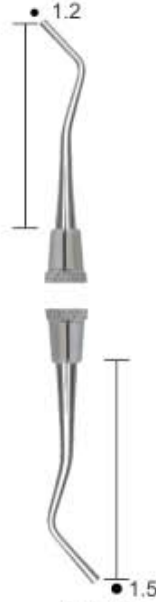

DE-646  
1  
Ward



DE-647  
2  
Ward

**FILLING INSTRUMENTS**

- Инструменты для реставрации
  - Instruments pour plombage
  - Füllungsinstrumente (mit Kontrawinkel)
- Інструменти для реставрації
  - Instrumentos para obturaciones
  - ملء الصكوك

**RESTORATIVE INSTRUMENTS SOLID HANDLE 6MM, LENGTH 170MM**  
Back Action Filling Instruments

**Tanner Filling Instruments**

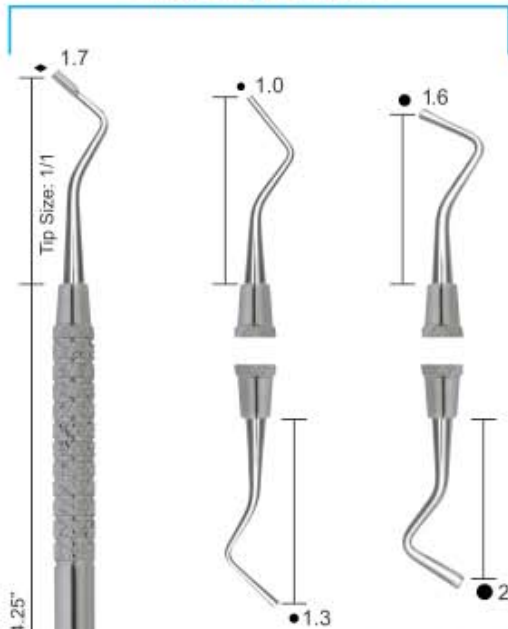

**DE-649**  
2T  
Tanner

**DE-650**  
3T  
Tanner



**DE-651**  
9/10  
Back Action



**DE-652**  
11/12  
Back Action



**DE-653**  
153  
English Pattern  
Serrated

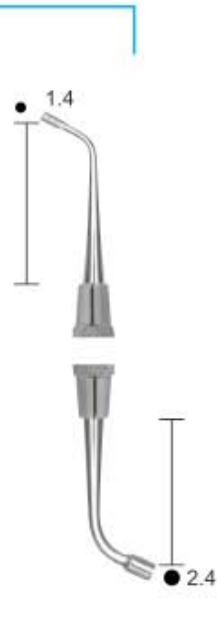

**DE-654**  
153  
English Pattern  
Serrated

Solid Handle Size 4.25"



**DE-648**  
1T  
Tanner

**BURNISHERS**



**DE-655**  
18  
#41, #6



**DE-656**  
26/27S  
#41, #6

**DE-657**  
27/29  
#41, #6, #7, #8



**DE-658**  
2

**DE-659**  
2  
Double-End



**DE-660**  
21  
#41, #6

**DE-661**  
21B  
#41, #6, #8



**DE-662**  
2  
Ladmore



- Инструменты для реставрации
- Instruments pour plombage
- Füllungsinstrumente (mit Kontrawinkel)
- Инструменти для реставрації
- Instrumentos para obturaciones
- ملء الصكوك

RESTORATIVE INSTRUMENTS SOLID HANDLE 6MM, LENGTH 170MM

BURNISHERS

PERIODONTAL FILES

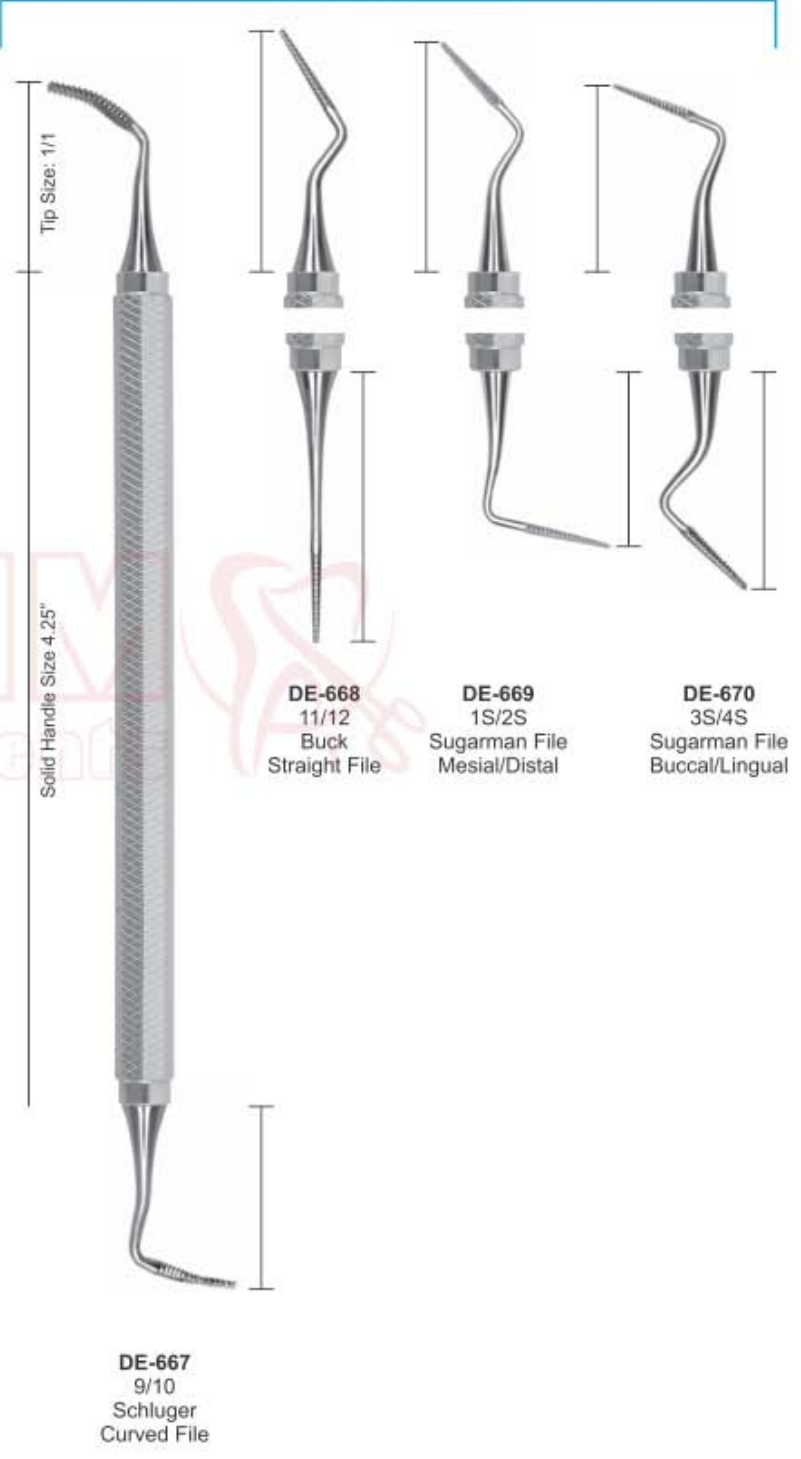
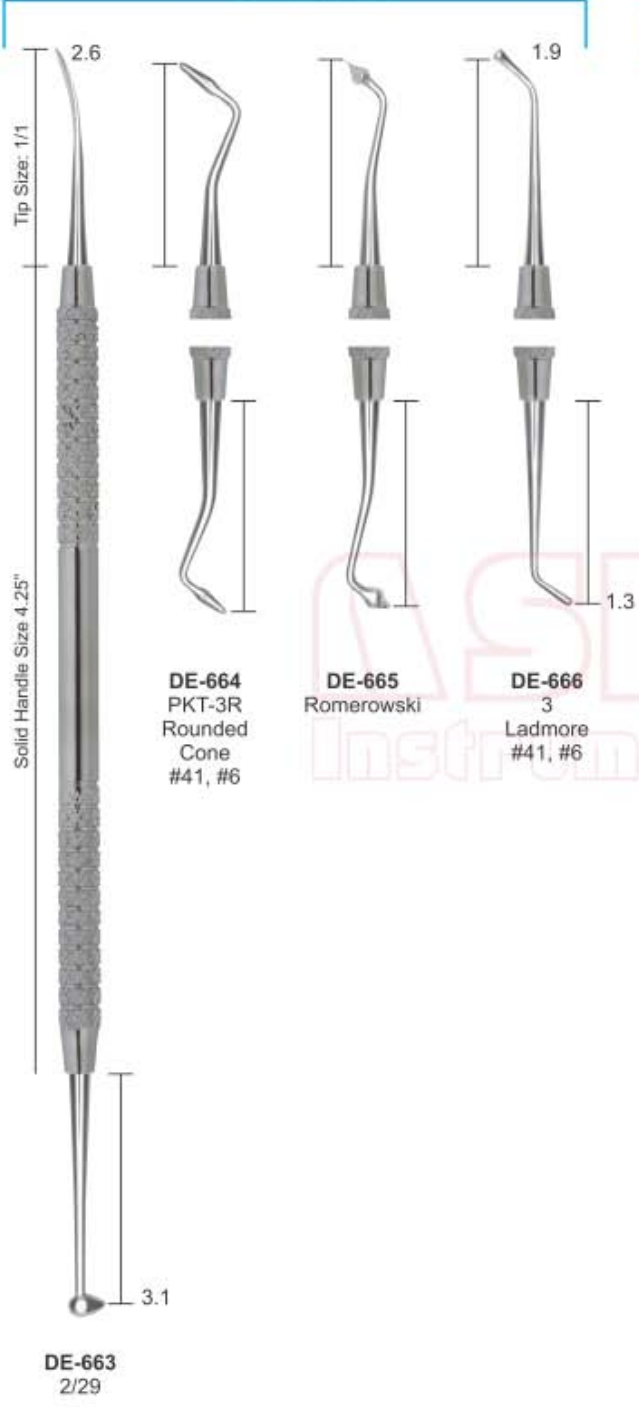

**FILLING INSTRUMENTS**

- Инструменты для реставрации
  - Instruments pour plombage
  - Füllungsinstrumente (mit Kontrawinkel)
- Інструменти для реставрації
  - Instrumentos para obturaciones
  - ملء التصكوك

**COMPOSITE/PLASTIC FILLING INSTRUMENTS  
SOLID HANDLE 6MM, LENGTH 170MM**

**BURNISHER FILLING INSTRUMENTS**

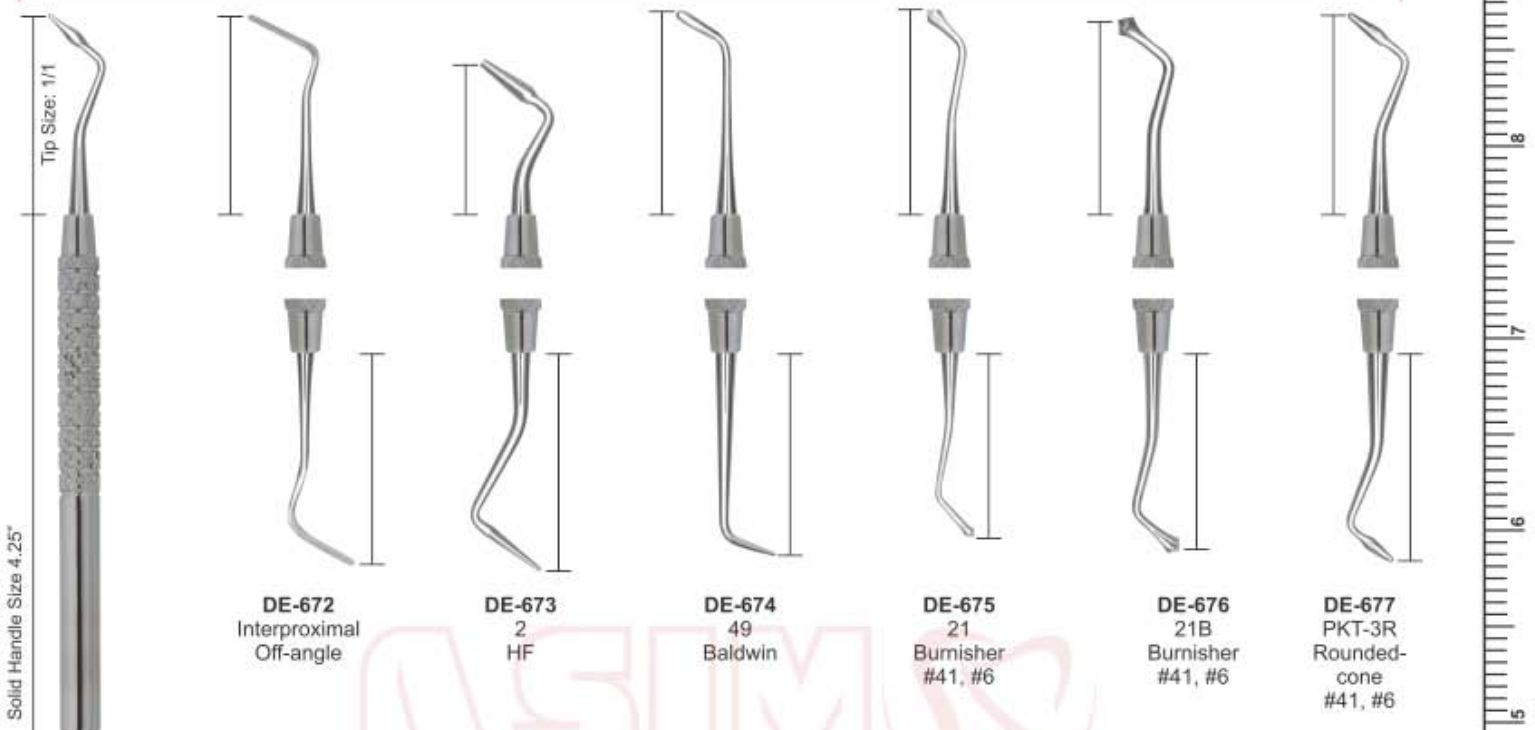

**UNIVERSAL FILLING INSTRUMENTS**

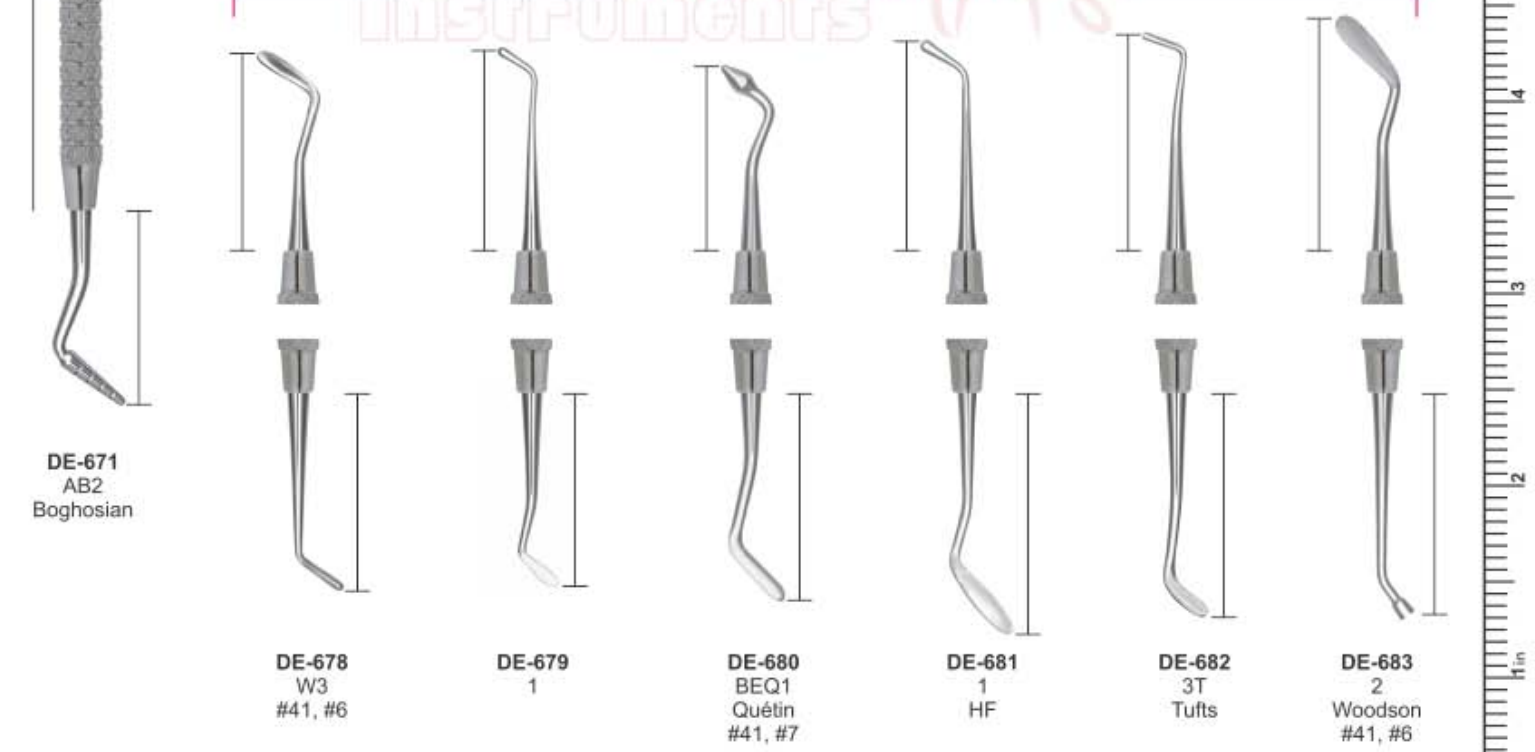



- Инструменты для реставрации
- Instruments pour plombage
- Füllungsinstrumente (mit Kontrawinkel)
- Инструменти для реставрації
- Instrumentos para obturaciones
- ملء الصكوك

FILLING INSTRUMENTS  
SOLID HANDLE 6MM, LENGTH 170MM



# AMALGAM CARVERS

- Инструменты для реставрации
  - Instruments pour amalgame
  - Amalgampistolen
- Інструменти для реставрації
  - Instrumentos para amalgama
  - تطعج الملعفم

AMALGAM INSTRUMENTS SOLID HANDLE 6MM, LENGTH 170MM



- Инструменты для реставрации
- Instruments pour amalgame
- Amalgampistolen
- Инструменти для реставрації
- instrumentos para amalgama
- تطعيم المنعم

AMALGAM INSTRUMENTS  
SOLID HANDLE 6MM, LENGTH 170MM



PERIODONTAL INSTRUMENTS

- Инструменты пародонтологические
- Instruments pour la parodontologie
- Instrumente für die Parodontologie
- Инструменти пародонтологічні
- Instrumentos para periodoncia
- المسكوك اللثة

SICKLE SCALERS INSTRUMENTS SOLID HANDLE 6MM, LENGTH 170MM

SICKLE SCALERS



Solid Handle Size 4.25"

**DE-724**  
H6/H7†  
Hygienist  
#2, #4, #6,  
#7, #8, #9

**DE-725**  
6/7  
Goldman  
#2, #4, #6,  
#7, #8

**DE-726**  
U15  
Towner  
#24, #6,  
#7, #8

**DE-727**  
H5/U15  
Hygienist-  
Towner  
#2, #4, #6

**DE-728**  
U15/30  
Towner-  
Jacquette  
#2, #4, #6  
#7, #8, #9

**DE-729**  
H15/33†  
Hygienist-  
Jacquette  
#2, #4, #6  
#7, #8, #9

**DE-730**  
U15/33  
Towner-  
Jacquette  
#2, #4, #6  
#7, #8, #9

INCHES

- Инструменты пародонтологические
- Instruments pour la parodontologie
- Instrumente für die Parodontologie

- Інструменти пародонтологічні
- Instrumentos para periodoncia
- الصكوك اللثة

PERIODONTAL INSTRUMENTS SOLID HANDLE 6MM, LENGTH 170MM

JACQUETTE SCALERS

CRANE-KAPLAN

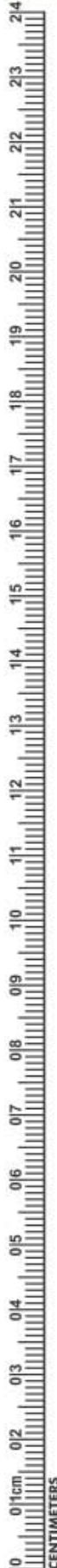

**DE-731**  
30/33  
Hygienist  
Jacquette  
#2, #4, #6,  
#7, #8, #9

**DE-732**  
31/32  
Jacquette  
#2, #4, #6,  
#7, #8, #9

**DE-733**  
34/35  
Jacquette  
#2, #4, #6,  
#7, #8, #9

**DE-734**  
H3/H4  
Jacquette  
#2, #4, #6,

**DE-735**  
14/15  
Posterior  
Jacquette  
#2, #4, #6,

**DE-736**  
CK-6  
#2, #4, #6,

**PERIODONTAL INSTRUMENTS**

- Инструменты пародонтологические
  - Instruments pour la parodontologie
  - Instrumente für die Parodontologie
- Інструменти пародонтологічні
  - Instrumentos para periodoncia
  - الصكوك اللثة

**PERIODONTAL INSTRUMENTS SOLID HANDLE 6MM, LENGTH 170MM  
SCALER/CURETTE SETS**



**DE-737**  
11/12  
Scaler  
#2, #6,  
#7, #8

**DE-738**  
11A/12A  
Scaler  
#2, #4, #6,

**DE-739**  
11/12S  
Modifed  
McCall  
#4, #6

**DE-740**  
13S/14S  
Pointed  
Curette  
#2, #4, #6  
#7, #8, #9

**DE-741**  
MTC 13/14  
Pointed  
Curette  
#4, #6

**DE-742**  
17S/18S  
Curette  
#2, #4, #6  
#7, #8, #9

**DE-743**  
19/20  
Curette  
#2



- Кюрети
- Curetas
- Kuretten
- Кюрети
- Curette
- کرتس

SCALER/CURETTE SETS

GOLDMAN-FOX SET



- |                                    |   |  |   |   |  |  |  |   |   |
|------------------------------------|---|--|---|---|--|--|--|---|---|
| <b>DE-744</b><br>103/106<br>#4, #6 | <b>DE-744A</b><br>104/105<br>Hoe/Chisel<br>#4, #6 | <b>DE-745</b><br>107/108<br>#2, #4, #6<br>#7, #8 | <b>DE-746</b><br>107/108S<br>Modied<br>#2, #4 | <b>DE-747</b><br>1/2<br>(shown)<br>#2, #4, #6<br>#7, #8, #9 | <b>DE-749</b><br>3/4†<br>(shown)<br>#2, #4, #6<br>#7, #8, #9 | <b>DE-751</b><br>5/6†<br>(shown)<br>#2, #4, #6<br>#7, #8, #9 | <b>DE-754</b><br>7/8†<br>(shown)<br>#2, #4, #6<br>#7, #8, #9 |   |   |
|                                    |   |  |   | <b>DE-748</b><br>1/2<br>Rigid<br>#2, #4, #6<br>#7, #8, #9   | <b>DE-750</b><br>3/4<br>Rigid<br>#2, #4, #6<br>#7, #8, #9    | <b>DE-752</b><br>5/6<br>Rigid<br>#2, #4, #6<br>#7, #8, #9    | <b>DE-753</b><br>5/6<br>Extra Rigid<br>#4, #6 #7,<br>#8      | <b>DE-755</b><br>7/8<br>Rigid<br>#2, #4, #6<br>#7, #8, #9 | <b>DE-756</b><br>7/8<br>Extra Rigid<br>#2, #4, #6<br>#7, #8, #9 |

SCALER/CURETTE SETS INSTRUMENTS  
SOLID HANDLE 6MM, LENGTH 170MM

# CURETTES

- Кюрети
- Curetas
- Kuretten
- Кюрети
- Curette
- كرتس

GRACEY CURETTE INSTRUMENTS SOLID HANDLE 6MM, LENGTH 170MM

## GRACEY CURETTES



**DE-757**  
9/10†  
(shown)  
#2, #4, #6  
#7, #8, #9

**DE-759**  
11/12†  
(shown)  
#2, #4, #6  
#7, #8, #9

**DE-792**  
13/14†  
(shown)  
#2, #4, #6  
#7, #8, #9

**DE-765**  
15/16†  
(shown)  
#2, #4, #6  
#7, #8, #9

**DE-767**  
17/18  
#2, #4, #6  
#7, #8, #9

**DE-758**  
9/10  
Rigid  
#2, #4, #6  
#7, #8

**DE-760**    **DE-761**  
11/12        11/12  
Rigid        Extra Rigid  
#2, #4, #6    #4, #6 #7,  
#7, #8, #9    #8

**DE-793**    **DE-764**  
13/14        13/14  
Rigid        Extra Rigid  
#2, #4, #6 #4, #6 #7,  
#7, #8, #9    #8

**DE-766**  
15/16  
Rigid  
#2, #4, #6  
#7, #8, #9

**DE-768**  
17/18  
Rigid  
#2, #4, #6  
#7, #8, #9



- Кюрети
- Curetas
- Küretten
- Кюрети
- Curette
- كرتس



**CURETTE INSTRUMENTS  
HOLLOW HANDLE 8.5MM, LENGTH 170MM**

**CURETTE INSTRUMENTS  
SOLID HANDLE 6MM, LENGTH 170MM**

**CURETTE INSTRUMENTS  
SOLID HANDLE 6MM, LENGTH 170MM**



**DE-769**  
Hemingway  
2mm, 2mm

**DE-770**  
Hemingway  
3mm, 3mm

**DE-771**  
Hemingway  
4mm, 4mm

**DE-772**  
Hemingway  
2mm, 2mm

**DE-773**  
Hemingway  
3mm, 3mm

**DE-774**  
Hemingway  
4mm, 4mm

**DE-775**  
Hemingway  
2mm, 2mm

**DE-776**  
Hemingway  
3mm, 3mm

**DE-777**  
Hemingway  
4mm, 4mm

# EXCAVATORS

- Экскаваторы
- Excavateurs
- Excavatoren
- Excavatori
- Excavadores
- حفارات

EXCAVATORS INSTRUMENTS SOLID HANDLE 6MM, LENGTH 170MM SPOONS

Instrument Model	Tip Size (inches)	Handle Size (inches)	Grain Size
DE-778 E1	1.2	4.25	(12-9-15) #41, #6
DE-779 E2	1.5	4.25	(15-9-15) #41, #6
DE-780 E3	2.5	4.25	(25-9-15)
DE-781 6	0.85	4.25	6
DE-782 14	1.5	4.25	14
DE-783 17	1.2	4.25	#41, #6, #7, #8
DE-784 18	1.5	4.25	#41, #6, #7, #8
DE-785 19	2.0	4.25	#41, #6, #7, #8
DE-786 38/39	1.15	4.25	(11.5-7-14) #41, #6, #7



- Экскаваторы
- Excavateurs
- Excavatoren
- Экскаватори
- Excavadores
- حفارات

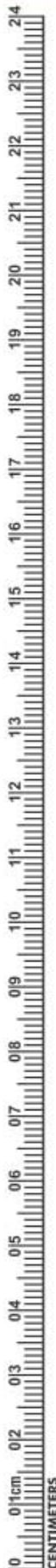

**EXCAVATORS INSTRUMENTS**  
SOLID HANDLE 6MM, LENGTH 170MM

OVAL SPOONS/DARBY-PERRY				EXCAVATORS				
1.2	1.5	1.8	1.5	1.5	1.0	1.3	1.5	2.0
DE-787 17W	DE-788 18W	DE-789 19W	DE-790 220/221 Darby-Perry #41, #6	DE-791 2 Glick	DE-792 31L #41, #6	DE-793 31W Oval Spoon	DE-794 32L #41, #6	DE-795 33L #41, #6

Tip Size: 1/1  
Solid Handle Size 4.25"

# EXCAVATORS

- Экскаваторы
- Excavateurs
- Excavatoren
- Excavatori
- Excavadores
- حفارات

**EXCAVATORS INSTRUMENTS  
SOLID HANDLE 6MM, LENGTH 170MM**

**BLADES**



- Экскаваторы
- Excavateurs
- Excavatoren
- Экскаватори
- Excavadores
- حفارات

EXCAVATORS INSTRUMENTS SOLID HANDLE 6MM, LENGTH 170MM

ENGLISH PATTERNS



<b>DE-802</b> Goldstein Interproximal Excavator	<b>DE-803</b> 243	<b>DE-804</b> 244	<b>DE-805</b> 245	<b>DE-806</b> 246	<b>DE-807</b> 125/126 #41, #6	<b>DE-808</b> 127/128 #41, #6	<b>DE-809</b> 129/130 #41, #6	<b>DE-810</b> 131/132 #41, #6	<b>DE-811</b> 153/154
--	----------------------	----------------------	----------------------	----------------------	-------------------------------------	-------------------------------------	-------------------------------------	-------------------------------------	--------------------------

**FILLING INSTRUMENTS**

- Инструменты для реставрации
  - Instruments pour plombage
  - Füllungsinstrumente (mit Kontrawinkel)
- Инструменти для реставрації
  - Instrumentos para obturaciones
  - ملء الصكوك

**HATCHETS**

**RESTORATIVE INSTRUMENTS SOLID HANDLE 6MM, LENGTH 170MM**

Tip Size: 1/1  
Solid Handle Size 4.25"

<b>DE-813</b> 13/14 (20-9-14)	<b>DE-814</b> 15/16 (15-8-14)	<b>DE-815</b> 17/18 (10-6-14) #41, #6	<b>DE-816</b> 51/52 (15-8-12)	<b>DE-817</b> 53/54 (10-6-12) #41, #6				
<b>DE-812</b> 8/9H (10-7-14) #41, #6	<b>DE-818</b> 8A #41, #6	<b>DE-819</b> 11 #41, #6	<b>DE-820</b> 179	<b>DE-821</b> G	<b>DE-822</b> 1/2 Trico	<b>DE-823</b> DPT6 Darby Perry Trimmer	<b>DE-824</b> W1	<b>DE-825</b> 1 Woodson #41, #6

**ANTERIOR**

INCHES  
0 1 2 3 4 5 6 7 8 9 10 11 12 13 14 15 16 17 18 19

- Инструменты для реставрации
- Instruments pour plombage
- Füllungsinstrumente (mit Kontrawinkel)
- Инструменти для реставрації
- Instrumentos para obturaciones
- ملء الصكوك

CARVERS

RESTORATIVE INSTRUMENTS SOLID HANDLE 6MM, LENGTH 170MM



Tip Size: 1/1

Solid Handle Size 4.25"

**DE-826**  
Inter-proximal  
#41, #6, #7



**DE-827**  
Inter-proximal  
Off-Angle



**DE-828**  
1/2-3  
Hollenback  
#41, #6,  
#7, #8



**DE-829**  
3S  
Hollenback  
#41, #6, #7



**DE-830**  
3  
Hollenback



**DE-831**  
8  
Wiland  
Minn.IPC1  
#41, #6, #7

TANNER

WALL

WARD



**DE-832**  
3  
Tanner



**DE-833**  
4  
Tanner



**DE-834**  
5  
Tanner



**DE-835**  
6  
Tanner



**DE-836**  
1  
Wall



**DE-837**  
3  
Wall



**DE-838**  
1  
Ward



**DE-839**  
2  
Ward

# AMALGAM CARVERS

- Инструменты для реставрации
- Instruments pour amalgame
- Amalgampistolen
- Инструменти для реставрації
- Instrumentos para amalgama
- تقطيع الملمف

**RESTORATIVE INSTRUMENTS**

**ANDREW SOLID HANDLE 6MM, LENGTH 170MM CLAPPISON/FRAHAM**

**HOLLENBACK**

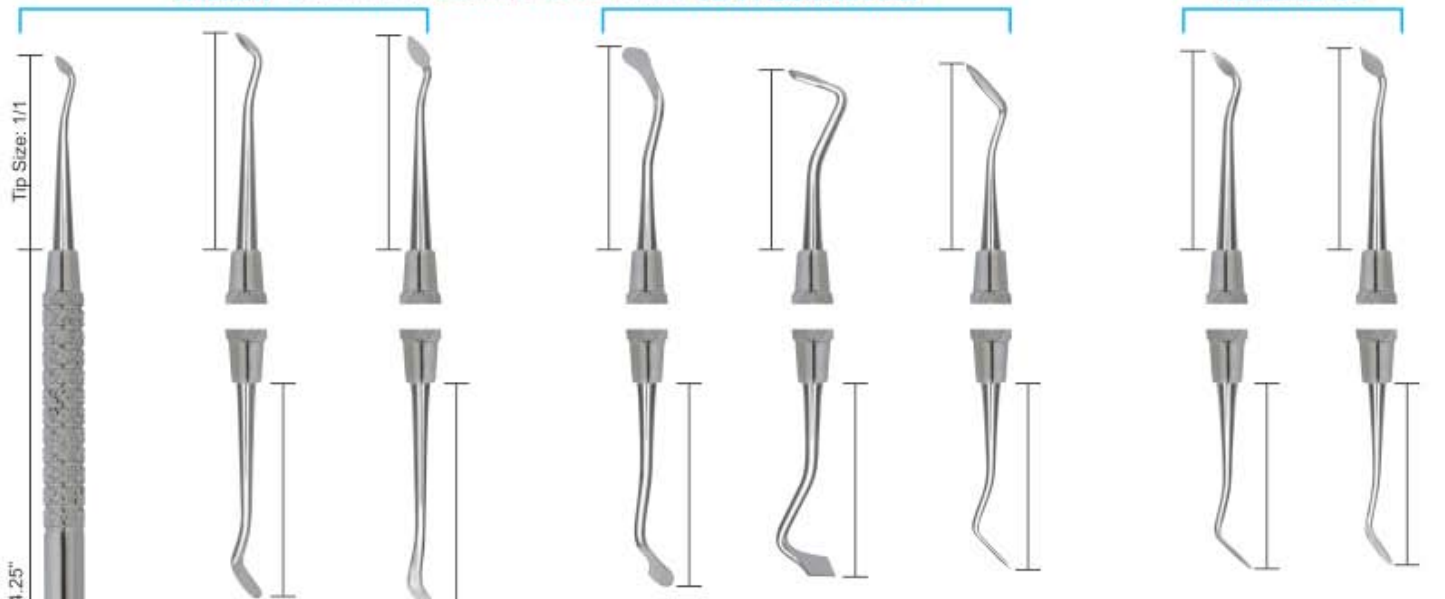

**DE-841**  
2  
Andrew

**DE-842**  
3  
Andrew

**DE-843**  
4  
Clappison

**DE-844**  
2/3  
Frahm  
#41, #6

**DE-845**  
104

**DE-846**  
1 Hollenback  
2 Modified  
Cleoid Small

**DE-847**  
1 Hollenback  
2 Modified  
Cleoid Large

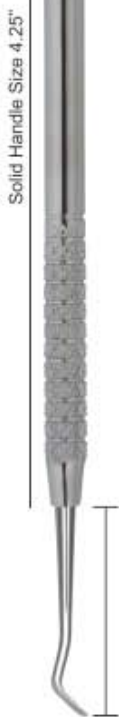

**DE-840**  
1  
Andrew

**HOLLENBACK**

**THARP**



**DE-848**  
1  
Hollenback

**DE-849**  
2  
Hollenback

**DE-850**  
L7  
Levy

**DE-851**  
SHO-A  
Shoshan

**DE-852**  
18  
Sprengel

**DE-853**  
1  
Tharp

**DE-854**  
2  
Tharp



- Инструменты для реставрации
- Instruments pour amalgame
- Amalgampistolen
- Инструменти для реставрації
- instrumentos para amalgama
- تقطیع المنجم

RESTORATIVE INSTRUMENTS SOLID HANDLE 6MM, LENGTH 170MM

CARVERS

AMALGAM FILES

HOES

Forming Line Angles on Anterior Preparations.



DISCOID-CLEOIDS

DISCOID-CLEOIDS



**FILLING INSTRUMENTS**

- Инструменты для реставрации
  - Instruments pour plombage
  - Füllungsinstrumente (mit Kontrawinkel)
- Инструменти для реставрації
  - Instrumentos para obturaciones
  - ملء الصكوك

**RESTORATIVE INSTRUMENTS  
SOLID HANDLE 6MM, LENGTH 170MM**

**MARGIN TRIMMERS**

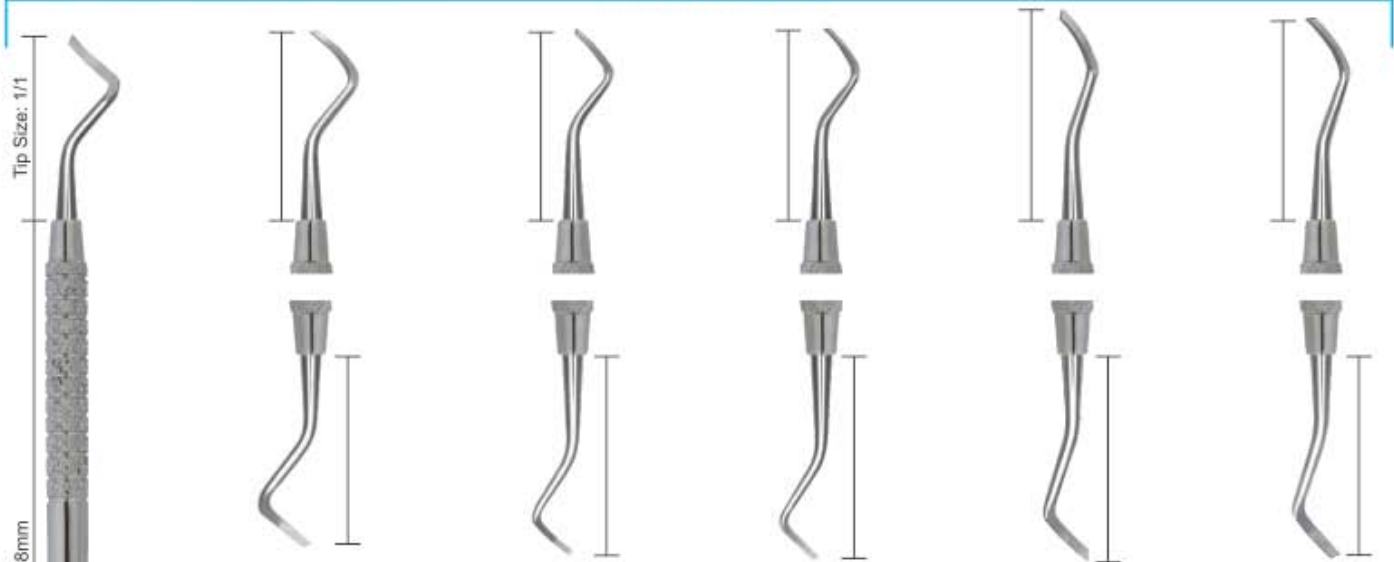

**DE-871**  
27  
(13-80-8-14)  
Mesial

**DE-872**  
28  
(10-95-7-14)  
Distal  
#41, #6

**DE-873**  
29  
(10-80-7-14)  
Mesial  
#41, #6

**DE-874**  
77/78  
(15-95-8-12)  
Distal

**DE-875**  
79/80  
(15-80-8-12)  
Mesial



**DE-870**  
26  
(13-95-8-14)  
Distal

**ANGLE FORMERS**

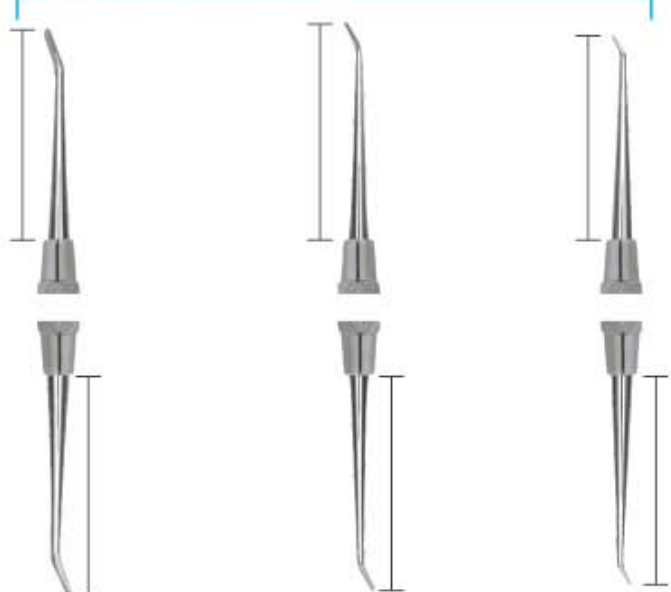

**DE-876**  
30/31  
(12-80-5-8)

**DE-877**  
32/33  
(9-80-4-8)

**DE-878**  
34/35  
(7-80-2.5-9)

- Инструменты для реставрации
  - Instruments a modeler
  - Modellierinstrumente
- Инструменти для реставрації
  - Instrumentos para modelar
  - أدوات تطعيم

P.K. THOMS WAXING INSTRUMENTS SOLID HANDLE 6MM, LENGTH 170MM

P.K. THOMAS WAXING INSTRUMENTS



DE1-884  
P.k. Thomas Waxing  
Instruments  
Kit



## COMPOSITE FILLING INSTRUMENTS

- Инструменты для реставрации
- Instruments pour plombage
- Füllungsinstrumente (mit Kontrawinkel)
- Инструменти для реставрації
- Instrumentos para obturaciones
- ملء الصكوك

### Composite Gold Tip Instruments

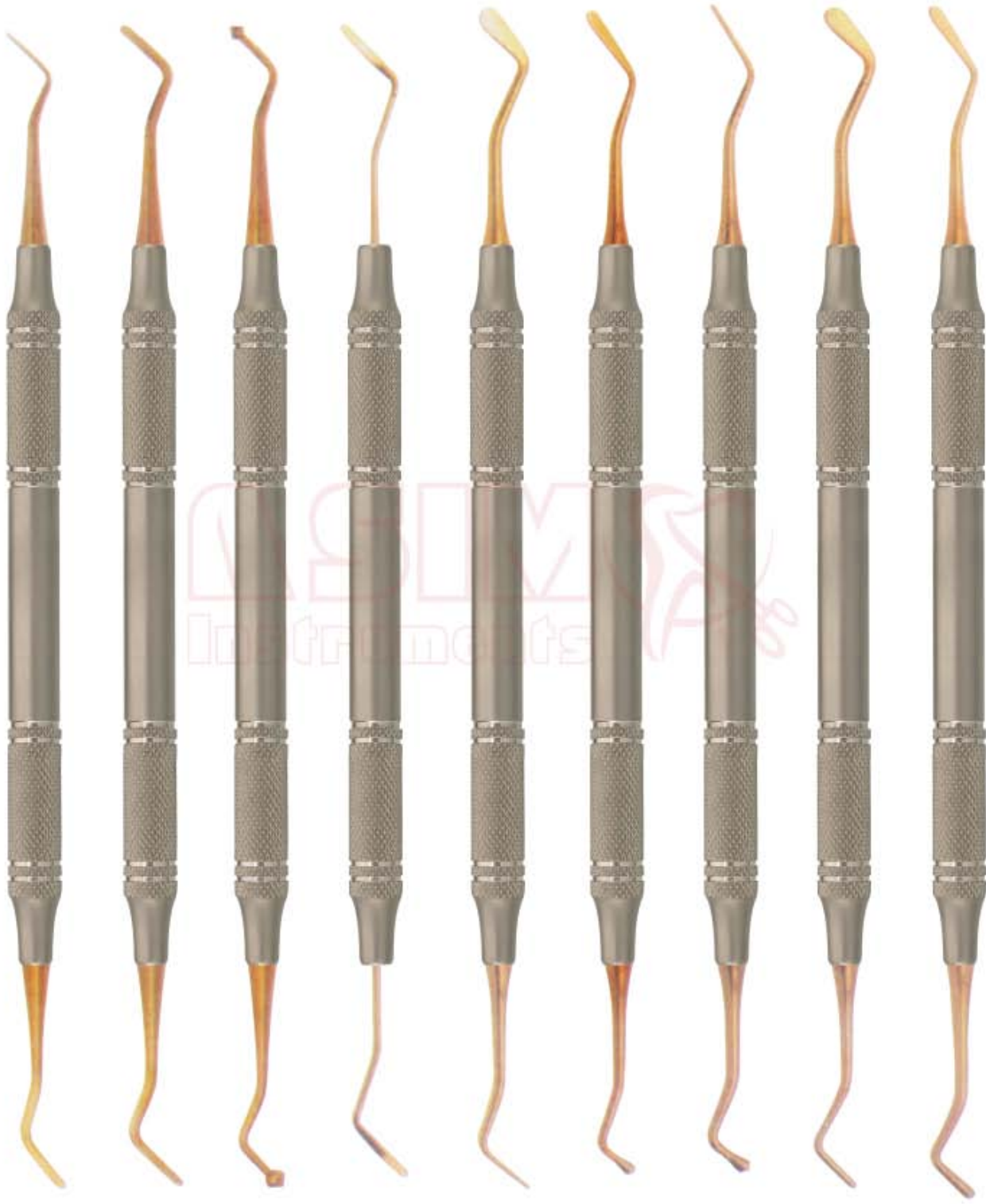

DE1-892

DE2-892

DE3-892

DE4-892

DE5-892

DE6-892

DE7-892

DE8-892

DE9-892

## COMPOSITE FILLING INSTRUMENTS

- Инструменты для реставрации
- Instruments pour plombage
- Füllungsinstrumente (mit Kontrawinkel)

- Инструменти для реставрації
- Instrumentos para obturaciones
- ملء الصكوك

### Composite Gold Tip Instruments



**DE10-892**  
Markley 2



**DE11-892**  
Westcott N.21



**DE12-892**  
NYU/B2



**DE13-892**  
Filling instruments



**DE14-892**  
Ball Filling Instruments



**DE15-892**  
Filling Instruments



**DE16-892**  
Filling Instruments



**DE17-892**  
Filling Instruments



**DE18-892**  
Plastic Filling Instruments



**DE19-892**  
Heidemann



**DE20-892**  
Plastic Filling Instruments

## FILLING INSTRUMENTS

- Инструменты для реставрации
- Instruments pour plombage
- Füllungsinstrumente (mit Kontrawinkel)
- Инструменти для реставрації
- Instrumentos para obturaciones
- ملء الصكوك

### COMPOSITE INSTRUMENTS TITANIUM BLUE ENDODONTIC

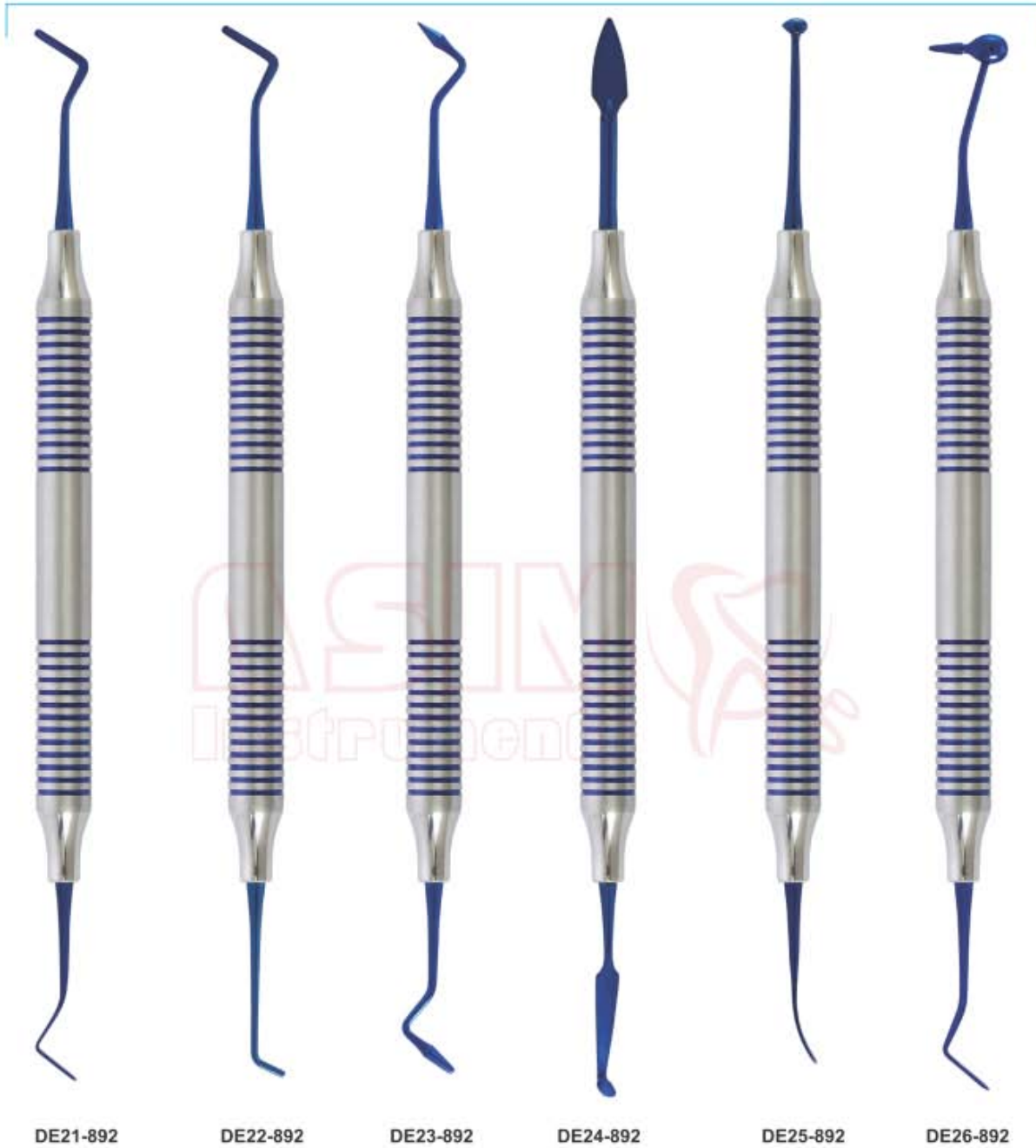

DE21-892

DE22-892

DE23-892

DE24-892

DE25-892

DE26-892



DE27-892  
Composite Instruments Blue  
Titanium with Cassettes



- Прочие товары
  - Divers produits et services
  - Sonstige Produkte
- Інші товари
  - Varios Productos
  - المنتجات المتنوعة



DE28-892  
X Ray Film Hangers



DE29-892  
X Ray Film Hangers



DE30-892  
X Ray Film Hangers



DE31-892  
X Ray Film Hangers



DE32-892  
X Ray Film Hangers



DE33-892  
X Ray Film Hangers



DE34-892  
X Ray Film Hangers



DE35-892



DE36-892



DE37-892



Dissecting Set  
DE38-892 Set of 9 Pcs.  
DE39-892 Set of 11 Pcs.



DE40-892  
Napkin Holder with  
Plastic Chain

DE41-892  
Napkin holder with metal chain

Key Rings



Mouth Props  
DE42-892  
Small

Mouth Props  
DE43-892  
Medium

Mouth Props  
DE44-892  
Large



DE45-892



DE46-892



DE47-892



DE48-892



DE49-892



DE50-892

**FILLING INSTRUMENTS**

- Инструменты для реставрации
  - Instruments pour plombage
  - Füllungsinstrumente (mit Kontrawinkel)
- Инструменти для реставрації
  - Instrumentos para obturaciones
  - ملء الصكوك

**CHISELS**

**HOES**





**CEMENT SPATULAS**

- Шпатели для цемента
- Spatules à ciment
- Zementspatel

- Шпатели для цементу
- Espátulas para cemento
- ملاعق الاسمنت

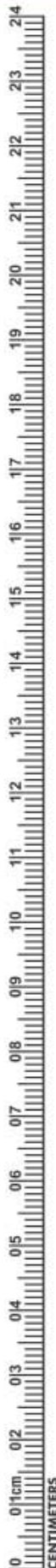

DE-893  
00

DE-894  
0

DE-895  
1

DE-896  
2

DE-897  
3

DE-898  
4

DE-899  
3  
Weston

DE-900  
1  
medium cement

DE-901  
1



DE-902  
Le Cron

DE-903  
Le Cron

DE-904  
Le Cron

DE-905  
MSY

DE-906  
MSY

DE-907  
Le Cron

DE-908  
Hylin

DE-909  
Hylin

DE-910  
Hylin

DE-911  
Zahle

DE-912  
Zahle

DE-913  
Zahle

DE-914  
Gritman

**WAX KNIVES**

- Ножи для воска
- Couteaux a cire
- Wachsmesser
- Ножі для воску
- Cuchillos para cera
- السكاكين الشمع

ALGINATE, PLASTER SPATULAS, WAX KNIVES PLASTER FOR KNIVES & PLASTER SHEAR

 <b>DE-915</b> Wooden Handle Fig. 5 21.5 cm	 <b>DE-916</b> Wooden Handle Fig. 7 19.5 cm curved	 <b>DE-917</b> Wooden Handle Fig. 8 20 cm curved	 <b>DE-918</b> Wooden Handle Fig. 9 22.5 cm curved	 <b>DE-919</b> Hook Knives	 <b>DE-920</b> Fig. 1 Lessmann 12.5 cm	 <b>DE-921</b> Fig. 2 Lessmann 17 cm	 <b>DE-922</b> Fig. 1 with small spoon 12.5 cm	 <b>DE-923</b> Fig. 2 with large spoon 17 cm
 <b>DE-924</b> Bacolite Handle Wax Knives, Small	 <b>DE-925</b> Bacolite Handle Wax Knives, Large	 <b>DE-926</b> Wooden Handle Wax Knives, Small	 <b>DE-927</b> Wooden Handle Wax Knives, Large	 <b>DE-928</b> Plaster Knife	 <b>DE-929</b> Fig. 1 17 cm	 <b>DE-930</b> Fig. 3 16 cm	 <b>DE-931</b> Fig. 4 16 cm	 <b>DE-932</b> Special Inox 19.5 cm



DE-933

**Technical Datas:**

Intercondylar distance	120 mm.
condylar inclination	fixed at 30°
Bennet angle	fixed at 7°
Incisal table inclination	10°
Distance between mounting plates	85 mm.
Weight	400 gr.
Opening (item 5000)	125°
Opening (item 5010)	180°



DE-934

**Technical Datas:**

Intercondylar distance	110 mm.
condylar inclination	fixed at 30°
Bennet angle	fixed at 7°
Incisal table inclination	flat
Distance between mounting plates	85 mm.
Weight	450 gr.
Opening	180°



DE-935

Stainless Steel Finishing  
DE-936  
Royal Blue

- Артикуляторы
- Artocilar
- Artikulations

- Артикулятори
- Articuler
- ارنیکو لائوس

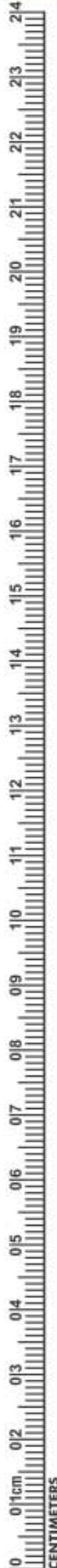

DE-937



DE-938



DE-939



DE-940



DE-941



DE-942



DE-943



DE-944



DE-945



DE-946  
Nakawalni  
Dental Laboratory  
Instrument

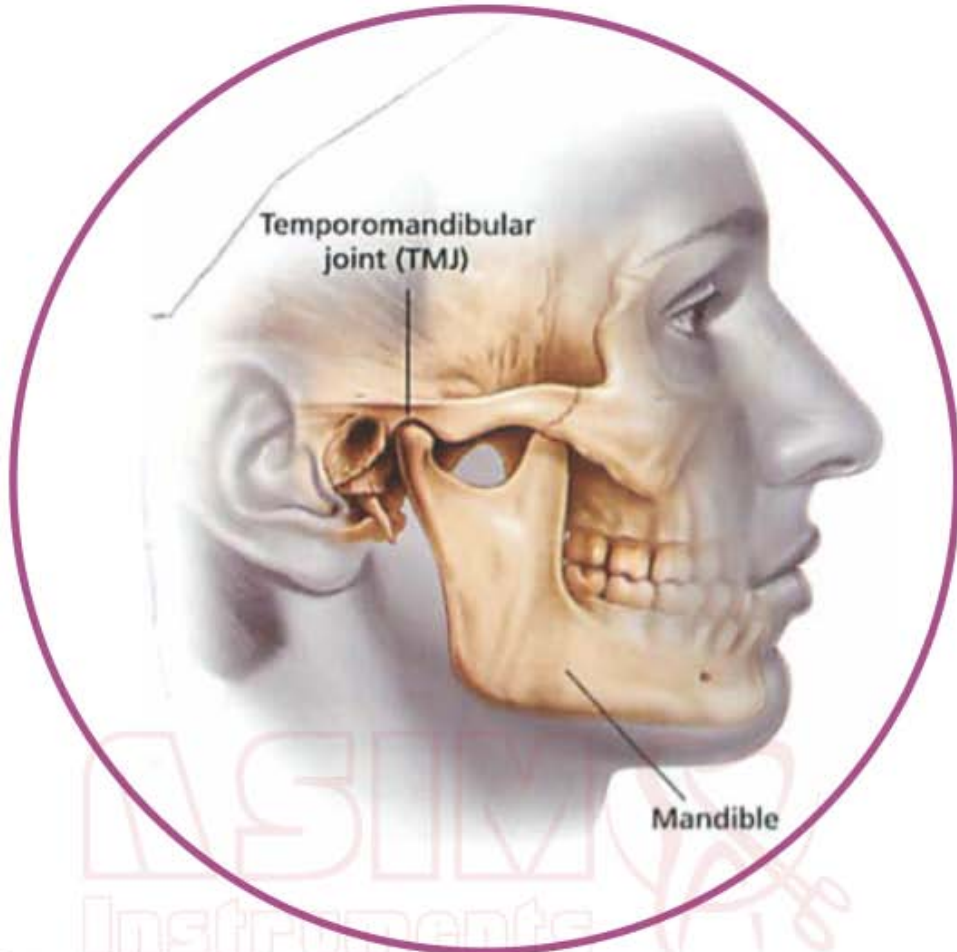

RETRACTORS - MOUTH GAGS

- Роторасширители
- Ecarteurs - Ouvre-bouches
- Vestibulumabhalter / Mundspanner
- Роторозширювачі
- Separadores - Abre-bocas
- الكاشطات-الكمامات الفم



**DE-947**  
Mouth Gag Molt  
11 cm for (Children)



**DE-948**  
Mouth Gag Molt  
14 cm for (Adults)



**Cheek Retractor**  
**DE-949** 140 mm  
**DE-950** 180 mm



**Cheek Retractor**  
**DE-951** 140 mm



**DE-952**  
**Wangen Holder,**  
vestibule  
15 cm, with or without  
lip protection,



**DE-953**  
**Wangen Holder,**  
vestibule 15 cm, with  
or without lip protection,



**DE-954**  
**Wangen Holder**  
Wangen holder with dual  
function, 17 cm,



**DE-955**  
140 mm

**DE-956**  
150 mm

**Cheek Retractor**

**RETRACTORS - MOUTH GAGS**

- Роторасширители
- Ecarteurs - Ouvre-bouches
- Vestibulumabhalter / Mundspanner
- Роторозширювачі
- Separadores - Abre-bocas
- الكاشطات-الكمامات الفم



**DE-957**  
Fig. 1  
weitlaner  
10.5cm  
13.5cm



**DE-958**  
Fig. 2  
weitlaner  
10.5cm  
13.5cm



**DE-959**  
Stainless Steel  
Double  
Ended Cheek  
Retractors



**DE-960**  
Stainless Steel  
Single  
Ended Cheek  
Retractors



Weitlander  
**DE-961** 11cm  
**DE-962** 13cm  
**DE-963** 15cm



**DE-967**  
Denhard  
12 cm



**DE-968**  
Roser-König  
16 cm



**DE-969**  
Roser-König  
19 cm



Jennings  
**DE-964** 11cm  
**DE-965** 13cm  
**DE-966** 15cm





**Wound, Bendable**  
Retractor, individually or as saving kit!

- Ранорасширители
  - Ecarteurs
  - Wundhaken
- Ранорозширювачі
  - Separadores
  - الكاشحات



**DE-970**  
Cheek Retractor  
Long



**DE-971**  
Cheek Retractor  
Long



**DE-972**  
Cheek Retractor  
Long



**Retractor with Ergo Grip**  
**DE-973** 24 cm,  
ergonomic handle,



**DE-974**  
Cheek Retractors,  
**Retractor Ivory**  
Width adjustable  
& fixable, 20 cm,



**Cheek Retractors,**  
tongue depressors  
**DE-975** 19 cm



**Cheek Retractors,**  
Minnesota  
**DE-976** 16 cm



**Cheek Retractors,**  
**DE-977** 20 cm  
easy to bend  
by hand,



**Cheek Retractors,**  
retractor and tongue  
pushers BISHOP with  
comfortable margin,  
**DE-978** 16 cm,



**Retractors Cheek**  
retractor combination  
Combination,  
**DE-979** 25 cm,

**RETRACTORS**

- Ранорасширители
- Ecarteurs
- Wundhaken
- Ранорозширювачі
- Separadores
- الكاشحات



**DE-982**  
Retractors, Unique  
Length 175 mm,  
angled 45°



**DE-983**  
Retractors, Unique  
Length 175 mm,  
angled 90°



**DE-984**  
Retractors  
16cm



**DE-985**  
Retractors  
19cm



**DE-986**  
Retractors, Mini-Langenbeck  
16 cm, hooks 22 mm,



**DE-987**  
Retractors, Cheek  
retractors combination  
21 cm, 2



**DE-988**  
Mini Retractor  
about 8 cm,



**DE-989**  
Retractors  
17 cm, hooks 22 mm





- Ранорасширители
  - Ecarteurs
  - Wundhaken
- Ранорозширювачі
  - Separadores
  - الكاشحات



**DE-990**  
Retractors, surgical-flat  
surgically-flat, 21 cm, hook  
30x16 mm,



**DE-991**  
Retractors, surgical-flat  
surgically-flat, 21 cm, hook  
42x11 mm



**DE-992**  
Retractors, surgical-flat  
surgically-flat, 21 cm, hook  
63x12 mm,



Retractors, surgical-flat  
surgically-flat, 21 cm, hook  
**DE-993** 30x16 mm,  
**DE-994** 42x11 mm,  
**DE-995** 63x12 mm,



Retractors, Langenbeck  
21 cm, hook  
**DE-996** 30x11 mm  
**DE-997** 30x16 mm,



**DE-998**  
Retractors  
21 cm,



**DE-999**  
Farabeuf  
(120 X 12mm  
Set of 2 pices)



**DE-1000**  
Retractor Seldin



**DE-1001**  
FELDMAN  
RETRACTOR  
5-1/2", 14cm



**GUM SCISSORS**

- Ножницы десневые
- Ciseaux a gencives
- Zahnfleischscheren
- Ножиці для ясен
- Tijeras para encias
- مقص صمغ



**DE-1002**  
Iris  
115mm  
Straight



**DE-1003**  
Iris  
115mm  
Curved



**DE-1004**  
Goldman-Fox  
130mm  
Saw edge, straight



**DE-1005**  
Goldman-Fox  
130mm  
Saw edge, Curved



**DE-1006**  
La Grange  
115mm  
Saw edge, double Curved



Mayo  
**DE-1007** 140mm  
**DE-1008** 170mm  
**DE-1009** 230mm  
Straight



Mayo  
**DE-1010** 140mm  
**DE-1011** 170mm  
**DE-1012** 230mm  
Curved



Metzenbaum  
**DE-1013** 145mm  
**DE-1014** 180mm  
**DE-1015** 200mm  
Straight



Metzenbaum  
**DE-1016** 145mm  
**DE-1017** 180mm  
**DE-1018** 200mm  
Curved



**DE-1019**  
Kelly  
160mm  
Straight



**DE-1020**  
Kelly  
160mm  
Curved



**DE-1021**  
Iris  
115mm  
Straight



**DE-1022**  
Iris  
115mm  
Curved



**DE-1023**  
La Grange  
115mm  
Double Curved



**DE-1024**  
Goldman-Fox  
130mm, Straight



**DE-1025**  
Goldman-Fox  
130mm, Curved



**DE-1026**  
Kelly  
160mm, Curved



**DE-1027**  
Iris  
115mm, Straight



**DE-1028**  
Iris  
115mm, Curved



**DE-1029**  
Micro Iris  
90mm, Curved



- Ножницы десневые
  - Ciseaux a gencives
  - Zahnfleischscheren
- Ножиці для ясен
  - Tijeras para encias
  - مقص صمغ



**DE-1030**  
Iris  
115mm  
Angled



**DE-1031**  
Iris  
115mm  
Curved



**DE-1032**  
Goldman-Fox  
130mm  
Saw edge,  
straight



**DE-1033**  
Goldman-Fox  
130mm  
Saw edge,  
curved



**DE-1034**  
Goldman-Fox  
130mm  
Saw edge,  
double curved



**DE-1035**  
La Grange  
115mm  
Saw edge,  
double curved



**DE-1036**  
Neumann  
120mm  
Saw edge,  
double curved



**DE-1037**  
Kilner (Ragnell)  
120mm  
Straight



**DE-1038**  
Kilner (Ragnell)  
120mm  
Curved



**DE-1039**  
Joseph  
140mm  
Straight



**DE-1040**  
Joseph  
140mm  
Curved



**DE-1041**  
Kelly  
160mm  
Straight



**DE-1042**  
Kelly  
160mm  
Curved



**DE-1043**  
Locklin  
160mm  
Saw edge,  
angular



**DE-1044**  
Locklin  
120mm  
160mm  
Saw edge,  
angular



**DE-1045**  
Dean  
170mm  
Saw edge,  
angular



**DE-1046**  
Spencer  
90mm



**DE-1047**  
Spencer  
130mm



**DE-1048**  
Spencer  
115mm



**DE-1049**  
Noyes  
110mm, Straight



**DE-1050**  
Noyes  
110mm  
Curved



**DE-1051**  
Noyes  
110mm  
Angular



**DE-1052**  
Castroviejo  
150mm  
Curved

NEEDLE HOLDERS

- Иглодержатели
  - Porte-aiguilles
  - Nadelhalter
- Голкотримачі
  - Porta-agujas
  - أصحاب إبرة



**DE-1053**  
130mm  
Straight



**DE-1054** Mayo  
130mm  
**DE-1055** Mayo  
160mm  
**DE-1056** Mayo  
180mm  
Straight Curved



**DE-1057** Mayo  
140mm  
**DE-1058** Mayo  
200mm  
Straight Curved



**DE-1059** Metzenbaum  
145mm  
**DE-1060** Metzenbaum  
200mm  
Straight Curved



**DE-1061**  
Beebee  
110mm  
Saw edge,  
straight



**DE-1062**  
Beebee  
110mm  
Saw edge,  
curved



**DE-1063**  
Beebee  
110mm  
Saw edge, straight



**DE-1064**  
Beebee  
110mm  
Saw edge, curved

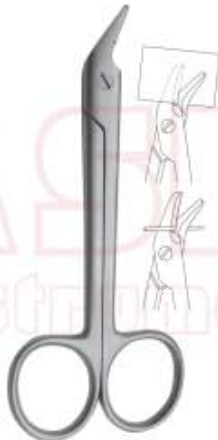

**DE-1065**  
Universal  
120mm  
Saw edge



**DE-1066**  
Universal  
120mm



Crile  
**DE-1067** 130mm  
**DE-1068** 150mm  
**DE-1069** 180mm



**DE-1070**  
Halsey  
130mm



**DE-1071**  
Baumgartner  
130mm



**DE-1072**  
Derf  
120mm



**DE-1073**  
Delicate  
150mm



Mayo-Hegar  
**DE-1074** 130mm  
**DE-1075** 160mm  
**DE-1076** 180mm  
**DE-1077** 200mm



**DE-1078**  
Crile-Wood  
150mm  
straight



**DE-1079**  
Crile-Wood  
150mm  
curved



NEEDLE HOLDERS

- Иглодержатели
- Porte-aiguilles
- Nadelhalter

- Голкотримачи
- Porta-agujas
- اصحاب ابرة



Castroviejo  
**DE-1080** 130mm  
**DE-1081** 150mm  
**DE-1082** 180mm



**DE-1083**  
 Halsey  
 130mm



**DE-1084**  
 Baumgartner  
 130mm



**DE-1085**  
 Derf  
 120mm



**DE-1086**  
 Delicate  
 150mm



**DE-1087**  
 Adson  
 170mm



Mayo-Hegar  
**DE-1088** 130mm  
**DE-1089** 160mm  
**DE-1090** 180mm  
**DE-1091** 200mm



**DE-1092**  
 Crile-Wood  
 150mm



Castroviejo  
**DE-1093** str 140mm cvd  
**DE-1094** str 180mm cvd



Olsen-Hegar Needle  
 Holder With Scissors  
**DE-1095** 140mm



Gillies Needle  
 Holder With Scissors  
**DE-1096** 160mm



Mathieu  
**DE-1097** 140mm  
**DE-1098** 170mm



Castroviejo  
**DE-1099** str 140mm cvd  
**DE-1100** str 180mm cvd



Olsen-Hegar Needle  
 Holder With Scissors  
**DE-1101** 140mm



Gillies Needle  
 Holder With Scissors  
**DE-1102** 160mm



**DE-1104**  
 125mm  
 Curved  
 Hartmann (Baby  
 Mosquito)  
**DE-1103** 90mm straight



**DE-1106**  
 Curved  
 Halstead Mosquito  
**DE-1105** 125mm  
 Straight

**HAEMOSTATIC FORCEPS & TOWEL CLAMPS**

- Зажимы артериальные, зажимы для салфеток
- Pincés hemostatiques, Pincés a compreses
- Arterienklemmen, Tuschklemmen
- Затискачі артеріальні, затискачі для серветок
- Pinzas hemostaticas, Pincas para compresas
- الملقط هيموستاتيک المشابك متشعبة

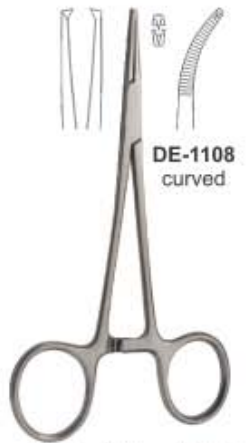

**DE-1108**  
curved

Halstead Mosquito 1x2  
**DE-1107** 125mm  
straight



**DE-1110**  
curved

Kelly  
**DE-1109** 140mm  
straight



**DE-1115** 140mm  
**DE-1116** 160mm  
**DE-1117** 180mm  
**DE-1118** 200mm  
curved

Rochester-Pean  
**DE-1111** 140mm  
**DE-1112** 160mm  
**DE-1113** 180mm  
**DE-1114** 200mm  
straight



**DE-1123** 140mm  
**DE-1124** 160mm  
**DE-1125** 180mm  
**DE-1126** 200mm  
curved

Rochester-Kocher 1x2  
**DE-1119** 140mm  
**DE-1120** 160mm  
**DE-1121** 180mm  
**DE-1122** 200mm  
straight



**DE-1128**  
curved

**DE-1127**  
Kelly-Rankin  
160mm  
straight



Lorna  
**DE-1129** 100mm  
**DE-1130** 130mm



**DE-1131**  
Allis-Baby 3:4  
150mm



**DE-1132**  
Allis 4:5  
200mm



**DE-1133**  
Allis 6:7  
200mm



Backhaus  
**DE-1134** 140mm  
Not-perforating and  
not-damaging



**DE-1135**  
Backhaus  
130mm



**DE-1136**  
Backhaus  
85mm



**DE-1137**  
Jones  
90mm



Gross Maier  
Dressing Forceps  
**DE-1138** 200mm straight



Foerster  
Dressing Forceps  
**DE-1140** 200mm



Young  
Tongue Forceps  
**DE-1141** 170mm



Collins  
Tongue Forceps  
**DE-1142** 170mm



RUBBER DAM CLAMPS FORCEPS

- Инструменты для системы коффердам
- Pincas porte-crampons a digue
- Kofferdam Klammerzangen
- Инструменты для системи коффердам
- Pinzas de engrapar para dique de caucho
- السد المطاط المناطق المشابهة



**DE-1143**  
On request the Content of the rubber dam kit can be changed with other instruments.

- Content:**
- 01 Anisworth
  - 02 Brewer
  - 03 Clamps Stand
  - 04 Denture Plate
  - 05 Rubber Dam Frame
  - 06 Rubber Dam Box Lower Case
  - 07 Rubber Dam Box Upper Case
  - 08 Rubber Dam Clamp Fig. 212
  - 09 Rubber Dam Clamp Fig. 211
  - 10 Rubber Dam Clamp Fig. 8
  - 11 Rubber Dam Clamp Fig. 8A
  - 12 Rubber Dam Clamp Fig. 14
  - 13 Rubber Dam Clamp Fig. 14A
  - 14 Rubber Dam Clamp Fig. 0
  - 15 Rubber Dam Clamp Fig. 00
  - 16 Rubber Dam Clamp Fig. 2
  - 17 Rubber Dam Clamp Fig. 2A
  - 18 Rubber Dam Clamp Fig. 7

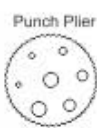
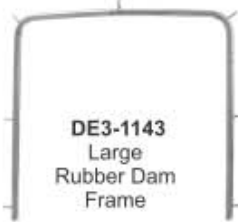

RUBBER DAM CLAMPS

- Кляммера для коффердама
- Crampons pour digue
- Kofferdam Klammern
- Кляммера для коффердама
- Grapas para dique de caucho
- المشابك السد المطاط



DE-1149  
Fig. 15



DE-1150  
Fig. 18



DE-1151  
Fig. 24



DE-1152  
Fig. 25



DE-1153  
Fig. 26



DE-1154  
Fig. 28



DE-1155  
Fig. 30



DE-1156  
Fig. 31



DE-1157  
Fig. 51



DE-1158  
Fig. 138



DE-1159  
Fig. 139



DE-1160  
Fig. 200



DE-1161  
Fig. 201



DE-1162  
Fig. 202



DE-1163  
Fig. 203



DE-1164  
Fig. 204



DE-1165  
Fig. 205



DE-1166  
Fig. 3



DE-1167  
Fig. W3



DE-1168  
Fig. 4



DE-1169  
Fig. 56A



DE-1170  
Fig. 7



DE-1171  
Fig. 7A



DE-1172  
Fig. 8



DE-1173  
Fig. 8A



DE-1174  
Fig. W8A



DE-1175  
Fig. 10



DE-1176  
Fig. 11



DE-1177  
Fig. 12A



DE-1178  
Fig. 13A



DE-1179  
Fig. 14



DE-1180  
Fig. 14A



DE-1181  
Fig. 14AN



DE-1182  
Fig. 22



DE-1183  
Fig. 27



DE-1184  
Fig. 207



DE-1185  
Fig. 29



DE-1186  
Fig. 206



DE-1187  
Fig. 208



DE-1188  
Fig. 209



DE-1189  
Fig. 1



DE-1190  
Fig. 1A



DE-1191  
Fig. 2



DE-1192  
Fig. 2A



DE-1193  
Fig. W2A



DE-1194  
Fig. 0



DE-1195  
Fig. 00



DE-1196  
Fig. 210



DE-1197  
Fig. 211



DE-1198  
Fig. 212



DE-1199  
Fig. 6



DE-1199  
Fig. 6



DE-1200  
Fig. 9



DE-1200  
Fig. 9



DE-1201  
Fig. N06



DE-1202  
Fig. U67



DE-1203  
Fig. 214



DE-1204  
Fig. P1



DE-1205  
Fig. P2



DE-1206  
Fig. G-1



DE-1207  
Fig. G-2





- Инструменты для удаления коронок
  - Arrache-couronnes
  - Teleskopkronenzangen
- Инструменти для видалення коронок
  - Arranca-corona
  - مزبلات التاج

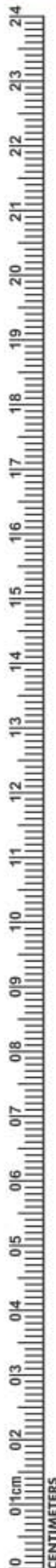

**DE-1210**  
Crown Spreaders



**DE-1211**  
Mershon  
14 cm  
Band Pusher



**DE-1212** Fig. 0  
Manual Crown Removers  
Handle with 3 tips  
Only 3 tips



DE2-1212



DE3-1212



DE4-1212



Manual Crown Removers  
Handle with 3 tips  
Only 3 tips



DE6-1212



DE7-1212



DE8-1212



**DE-1213**  
Manual Crown Remover



**DE-1214**  
Complete with 3 tips  
and tightening keys

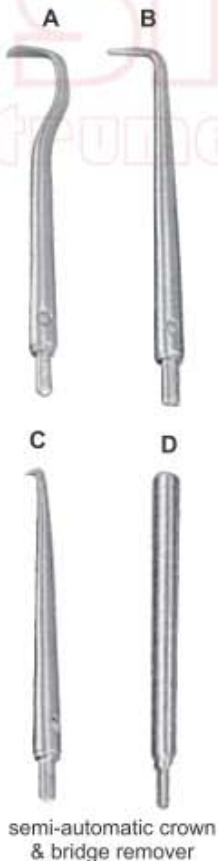

semi-automatic crown  
& bridge remover



**DE-1215**



**DE-1216**  
Manual Crown Remover



**MATRIX RETAINERS**

- Матрицедержатели
- Porte Matrices
- Matrizenspanner

- Матрицеутримувачи
- Porta Matrices
- مصفولة الخدم



**DE-1217**  
Fig. 5  
Ivory 8  
5 cm



**DE-1218**  
Fig. 6  
Ivory 8  
6 cm



**DE-1219**  
Fig. 7  
Ivory 8  
7 cm



**DE-1220**  
Fig. 1  
Tofflemire-Universal



**DE87-1220**



**DE1-1220**



**DE2-1220**

**Siqveland Retainers**



**DE-1221**  
Fig. 2  
Tofflemire-Junier



**DE-1222**  
Fig. 3  
Tofflemire-Senior



**DE-1223**  
Narrow



**DE-1224**  
Wide



**Amalgam Well**

**DE-1225**  
Stainless Steel  
Amalgam Well



**DE-1226**  
Ivory 12



**DE-1227**  
Ivory 1



**DE-1228**  
Ivory



**DE-1229**  
Elliot



AMALGAM INSTRUMENTS & SCALPEL HANDLES

Инструменты для амальгамы  
 • Instruments pour amalgame  
 • Amalgamis/instrumente

• Инструменти для амальгами  
 • Instrumentos para amalgama  
 • الصكوك المنغم

• Ручки для скальпелей  
 • Manches de bistouris  
 • Skalpellgriffe

• Ручки для скальпелів  
 • Mangos de bisturi  
 • مشرط مقبض

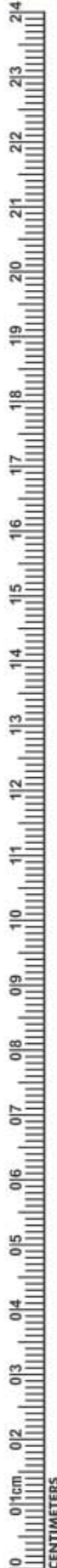

Ø 2mm

DE-1230  
 Fig. 10  
 165mm  
 English pattern



Ø 2mm

DE-1231  
 Fig. 1  
 185mm  
 German pattern



Ø 2mm

DE-1232  
 Fig. 1  
 150mm  
 Swiss pattern



Ø 2mm

DE-1233  
 Fig. 1  
 150mm



Ø 2mm

DE-1234  
 Fig. 2  
 150mm, 45°



Ø 2mm

DE-1235  
 Fig. 3  
 140mm, 90°



DE-1236  
 Fig.3  
 5" (12.7cm)



DE-1237  
 Fig.3G  
 5" (12.7cm)



DE-1238  
 Fig.4  
 5 1/2" (13.7cm)



DE-1239  
 6 Way Adjustable Angled Scalpel Handle



Locks At 90°, 60°, 30°,  
 Straight, 120°, 150°, 180°,  
 Angles

AMALGAM INSTRUMENTS

- Инструменты для амальгамы
- Instruments pour amalgame
- Amalgam's instrumente
- Инструменти для амальгами
- Instrumentos para amalgama
- الصكوك الملعف

AMALGAM CARRIERS

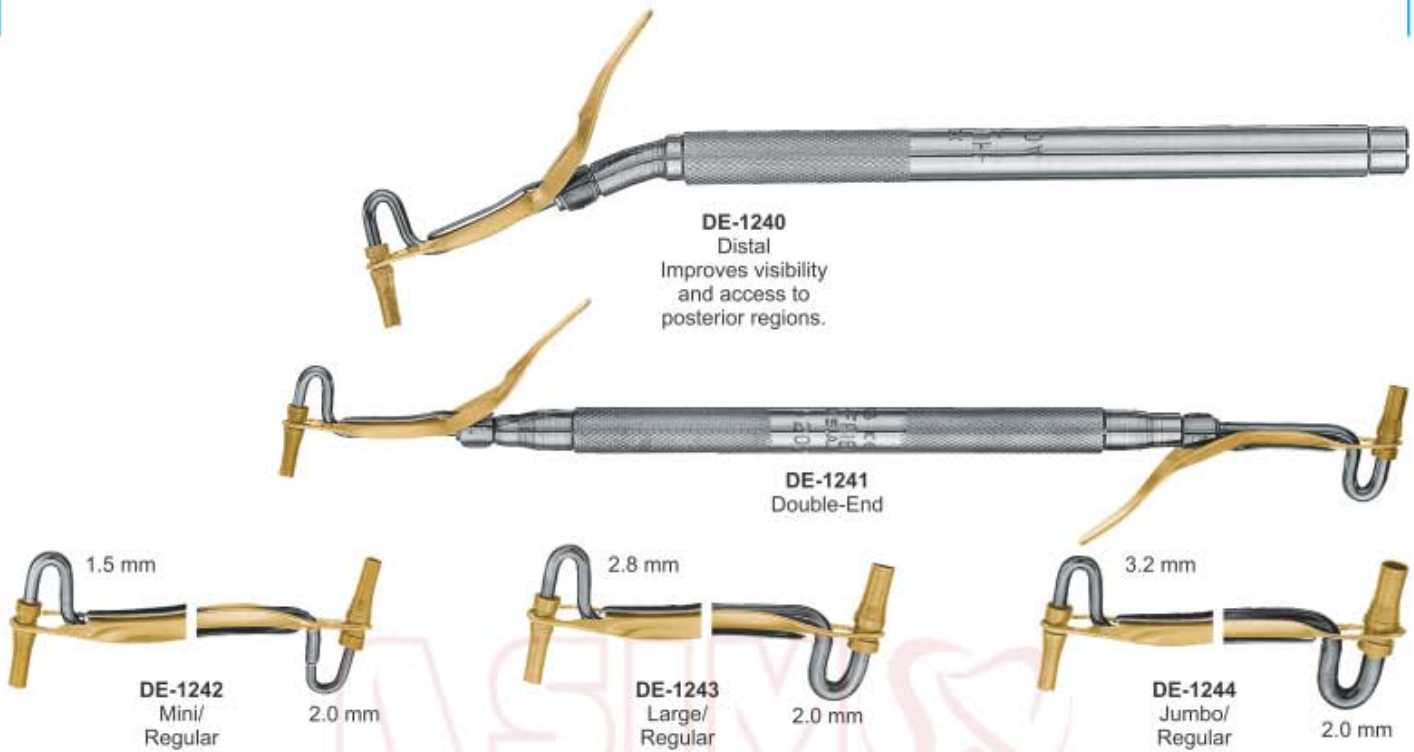

**DE-1240**  
Distal  
Improves visibility and access to posterior regions.

**DE-1241**  
Double-End

**DE-1242**  
Mini/  
Regular

**DE-1243**  
Large/  
Regular

**DE-1244**  
Jumbo/  
Regular

TIP SIZES FOR DOUBLE-END



DE-1245 - 1.5mm-2.0mm    DE-1248 - 1.0mm-2mm  
DE-1246 - 2.0mm-2.8mm    DE-1249 - 2.0mm-3mm  
DE-1247 - 2.0mm-3.2mm    DE-1250 - 2.0mm-4mm

DE1-1250 - 1.5mm-2.0mm    DE4-1250 - 1.0mm-2mm  
DE2-1250 - 2.0mm-2.8mm    DE5-1250 - 2.0mm-3mm  
DE3-1250 - 2.0mm-3.2mm    DE5-1250 - 2.0mm-4mm

DE7-1250 - 1.5mm-2.0mm    DE10-1250 - 1.0mm-2mm  
DE8-1250 - 2.0mm-2.8mm    DE11-1250 - 2.0mm-3mm  
DE8-1250 - 2.0mm-3.2mm    DE12-1250 - 2.0mm-4mm

DE13-1250 - 1.5mm-2.0mm    DE16-1250 - 1.0mm-2mm  
DE14-1250 - 2.0mm-2.8mm    DE17-1250 - 2.0mm-3mm  
DE15-1250 - 2.0mm-3.2mm    DE18-1250 - 2.0mm-4mm

DE19-1250 - 1.5mm  
DE20-1250 - 2.0mm  
DE21-1250 - 2.0mm  
DE22-1250 - 3.0mm



**DE-1251**  
Amalgam  
Well



**ROOT PLANNING FILES**



**DE-1252**  
Kramer-Nevis  
Bone Chisel



**DE-1253**  
Kramer-Nevis  
Bone Chisel



**DE-1254**  
Molt 18.5cm  
Auto Clavable  
Plastic Tips.



**DE-1255**  
Mead 18.5cm  
Non Auto Clavable  
Plastic Tips.



**DE-1256**  
Miller



**DE-1257**  
Miller

**BONE FILES**



**DE-1258**  
Miller 21



**DE-1259**  
Miller 1X  
cross cut



**DE-1260**  
Miller 2X  
cross cut



**DE-1261**  
Miller 52



**DE-1262**  
Wahl 1



PERIODONTAL INSTRUMENTS

- Инструменты пародонтологические
- Instruments pour la parodontologie
- Instrumente für die Parodontologie
- Инструменти пародонтологічні
- Instrumentos para periodoncia
- الصكوك اللثة

PERIOSTEEL ELEVATORS





Behind Every Smile is a Story

- QUALITY - ЯКІСТЬ • PRECISION - ТОЧНІСТЬ • ACCURACY - ПРАВИЛЬНІСТЬ • DURABILITY - ЗНОСОСТІЙКІСТЬ



- Super-sharp diamond-bead cutters
- smooth ultra-polished and contoured edges
- brilliant corrosion resistant stainless steel finish

- superior T12 stainless steel tool inserts
- sliding lock joint for balance & precise alignment

STYLE A



- Super-sharp diamond-bead cutters
- smooth ultra-polished and contoured edges
- brilliant corrosion resistant stainless steel finish

- superior T12 stainless steel tool inserts
- sliding lock joint for balance & precise alignment

STYLE B



**ORTHODONTIC INSTRUMENTS**

- Инструменты ортодонтические
- Instrumentos Ortodonticos
- Orthodontische Instrumente
- Инструменти ортодонтични
- Instruments Orthodontiques
- أدوات تقويم الأسنان



**DE-1277**  
Aluminum Height  
Gauge 0.22



**DE-1278**  
Aluminum Height  
Gauge 0.18



**DE1-1278**  
Height Gauge  
Movable



**DE-1279**  
Bone Bracket Gauge



**DE2-1279**  
Endo Finger  
Ruler Span  
Measure Scale



**DE1-1279**  
Endo Finger  
Ruler Span  
Measure Scale



**DE3-1279**  
Endo Finger  
Ruler Span  
Measure Scale



**DE4-1279**  
Compasso  
De Willis



**DE-1280**  
Bone Thickness  
Gauge  
40mm, 180mm



**DE-1281**  
Osteometer  
Measuring Forceps



**DE-1282**  
Bracket Placer  
Tweezers  
(Extra Fine Tip)



**DE-1283**  
Direct Bonding  
Bracket Holders  
135mm



**DE-1284**  
Direct Bonding  
Bracket Holders  
136mm



**DE-1285**  
Direct Bonding  
Bracket Holders  
135mm



**DE-1286**  
Deluxe Bracket  
Holder



**DE-1287**  
Deluxe Bracket  
Holder Tweezers



**DE-1288**  
Deluxe Bracket  
Holder Tweezers



**DE1-1288**  
Bracket Tweezers  
Slot Aligner



**DE2-1288**  
Direct Bonding  
Bracket Holders  
140mm



**DE3-1288**  
Bracket Placing  
Tweezers



**DE4-1288**  
Easy Access  
Tweezers



**DE5-1288**  
Direct Bonding  
Bracket Holders  
140mm



**DE6-1288**  
Direct Bond Bracket  
Holder Tweezers  
Small Tip



**DE7-1288**  
Exact Bracket  
Holder Tweezers



**DE8-1288**  
Easy Ecess  
Tweezers



**DE9-1288**  
Slipper Tweezers





**ORTHODONTIC INSTRUMENTS**

- Инструменты ортодонтические
- Instrumentos Ortodonticos
- Orthodontische Instrumente
- Инструменти ортодонтични
- Instruments Orthodontiques
- أدوات تقويم الأسنان



## ORTHODONTIC INSTRUMENTS

- Инструменты ортодонтические
- Instrumentos Ortodonticos
- Orthodontische Instrumente
- Инструменти ортодонтични
- Instruments Orthodontiques
- أدوات تقويم الأسنان



**DE-1302**  
Ortho Light double ended  
ligature director



**DE-1303**  
Ortho Light double ended  
ligature director scaler



**DE-1304**  
Ortho Light double ended ligature scaler director tivate coil spring  
are remove modules with one instruments



**DE-1305**  
Ortho band pusher scaler



**DE-1306**  
Ortho Light Band Pusher Scaler



**DE-1307**  
Ortho ligature director single ended



**DE-1308**  
Ortho Light double ended ligature  
director scaler



**DE-1309**  
Ortho Light double ended ligature scaler/director  
tivate coil spring are remove modules with one instruments



**DE-1310**  
Ortho Light double ended ligature director



**DE-1311**  
Ortholite Ligature Director Scaler



**DE-1312**  
Ortho light ligature director double ended



**DE-1313**  
Double ended cement spatula



**DE-1314**  
Ortho light scaler single ended



**PLIERS FOR ORTHODONTICS & PROSTHETICS**

- Щипцы для ортодонтии и протезирования
- Pinces pour l'orthodontie et la prothèse
- Zangen für Kieferorthopädie und Prothetik
- Щипці для ортодонції та протезування
- Alicates para ortodoncia y prótesis
- كمانشة لتقويم الأسنان بروسشيس

**BOX JOINT PLIERS**



**DE-1315**  
Universal Dolphin Style  
Wire Bending & cutting pliers



**DE-1316 Band Removing Plier**  
The curved blade of the band removing plier can strip easily and gently remove directly to the tooth. Length 130mm



**DE-1317**  
Tweed Loop forming Pliers



**DE-1318**  
How Plier curved  
Universally usable tool for the multiband technology for wires up to .028". Length 130mm



**DE-1319** How Plier  
Universally usable tool for the multiband technology for wires up to .028". Length 135mm



**DE-1320**  
Nance Loop forming Pliers



**DE-1321**  
Bracket Removing Plier curved  
Bracket Removing Plier curved for easy removal of brackets in the posterior region. Length 130mm



**DE-1322**  
Young Wire Bending & Loop Forming Pliers



**DE-1323**  
Wire Bending & Loop Forming Pliers



**DE-1324**  
Adams, small wire bending and loop forming Pliers



**DE-1325**  
Bracket Removing Plier Round Box  
Bracket removing plier for comfortable and quick removal of the brackets. Length 135mm



**DE-1326**  
Weingart Plier medium  
Weingart plier that are ideal due to their curved tip for setting sheets and is capable of bending the ends. Length 145mm



**PLIERS FOR ORTHODONTICS & PROSTHETICS**

- Щипцы для ортодонтии и протезирования
- Pincers pour l'orthodontie et la prothèse
- Zangen für Kieferorthopädie und Prothetik
- Щипці для ортодонції та протезування
- Alicates para ortodoncia y prótesis
- كمانة لتقويم الأسنان بروتستیس

**BOX JOINT PLIERS**

**DE-1327 Adams Plier Round Box**

Adams pliers for bending wire arches and bends right angles for wires up to .022", .025 tip to beak. Length 125mm



**DE-1333 Adams Plier**

Adams pliers for bending wire arches and bends right angles for wires up to .022", .025 tip to beak. Length 125mm



**DE-1328**

Falcon Beak Contouring Pliers.



**DE-1334**

Tweed Loop Formin Pliers



**DE-1329**

wires up to 0.020" / 0.7mm.



**DE-1335 Bird Beak Plier Standard**

Bird Beak Wire bending plier without notches, which is suitable as a universal utility tool. Length 125mm



**DE-1330**

Johnson Contouring Pliers



**DE-1336**

Mini Ligature cutters



**DE-1331 Aderer**

Large wire bending and loop forming pliers



**DE-1337 Small Fluch-cut distal and cutting Pliers**

with safety hold fitted with un-breakable, corrosion resistant and durable stainless steel tips



**DE-1332**

Tweed / angle rectangular arch forming & Torquing pliers



**DE-1338 Large Fluch-cut distal and cutting Pliers**

with safety hold fitted with un-breakable, corrosion resistant and durable stainless steel tips



**PLIERS FOR ORTHODONTICS & PROSTHETICS**

- Щипцы для ортодонтии и протезирования
- Pincas pour l'orthodontie et la prothèse
- Zangen für Kieferorthopädie und Prothetik
- Щипці для ортодонції та протезування
- Alicates para ortodoncia y prótesis
- كمانشة لتقويم الأسنان بروستھتیس

**BOX JOINT PLIERS**

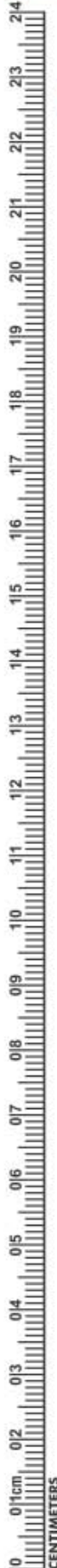

**DE-1339**  
**Tweed / Angel**  
1.78mm (.070") wide tips arch forming and torquing pliers



**DE-1340**  
**Tweed / Angel**  
1.78mm (.070") wide tips arch forming and torquing pliers



**DE-1341**  
**Lingual / Palatal arch**  
forming pliers



**DE-1342**  
**Aderer**  
Facebow loop forming Pliers



**DE-1343**  
Waldsavhs wire bending and cutting pliers



**DE-1344 Aderer Plier**  
For the manufacturing of appliances and activation of wires for wires up to .030" .fine tip and up to .036" mean tip. Length 130mm



**DE-1345**  
Contouring Plier



**DE-1346**  
**Bands & Crowns Plier**  
in order to skirt



**DE-1347**  
**Ligature Forming Pliers**



**DE-1348**  
for double back and triple back bands in 0.30" / 0.76mm & 0.36" / 0.91mm lingual arch wires



**DE-1349**  
**Bird Beak Wire Bending & cutting pliers**



**DE-1350**  
**Weingart Plier medium**  
Weingart plier that are ideal due to their curved tip for setting sheets and is capable of bending the ends. Length 145mm



**PLIERS FOR ORTHODONTICS & PROSTHETICS**

- Щипцы для ортодонтии и протезирования
- Pincers pour l'orthodontie et la prothèse
- Zangen für Kieferorthopädie und Prothetik
- Щипці для ортодонції та протезування
- Alicates para ortodoncia y prótesis
- كمانشة لتقويم الأسنان بروتثیتیس

**L-KEY JOINT PLIERS**



**DE-1351**  
Distal end cutter with safety hold, mini head, long handles. fitted with un-breakable, corrosion resistant and durable stainless steel tips

- 0.30 mm to 0.50 mm (.012" to .020")
- Max. 0.46 mm x 0.64 mm (.018" x .025")
- ⊗ 0.38 mm to 0.53 mm (.0155" to .0215")
- ⊗ Max. 0.53 mm x 0.64 mm (.021" x .025")



**DE-1355**  
Soft wire and ligature cutter, 15° angled fitted with un-breakable, corrosion resistant and durable stainless steel tips

- ⌋ .25 mm to .38 mm (.010" to .015")



**DE-1352**  
Flush-cut distal end cutter with safety hold fitted with un-breakable, corrosion resistant and durable stainless steel tips

- 0.30 mm to 0.50 mm (.012" to .020")
- Max. 0.46 mm x 0.64 mm (.018" to .025")



**DE-1356**  
Soft wire and ligature cutter, 45° angled fitted with un-breakable, corrosion resistant and durable stainless steel tips

- ⌋ .25 mm to .38 mm (.010" to .015")



**DE-1357**  
Hard wire cutter, straight Fitted with un-breakable, corrosion resistant and durable stainless steel tips

- 0.30 mm to 0.50 mm (.012" to .020")
- Max. 0.56 mm x 0.71 mm (.022" x .028")



**DE-1353**  
Soft wire and ligature cutter, Mini fitted with un-breakable, corrosion resistant and durable stainless steel tips

- ⌋ .25 mm to .38 mm (.010" to .015")



**DE-1358**  
Hard wire cutter, 15° angled Fitted with un-breakable, corrosion resistant and durable stainless steel tips

- 0.30 mm to 0.50 mm (.012" to .020")
- Max. 0.56 mm x 0.71 mm (.022" x .028")



**DE-1359**  
Hard wire cutter, 15° angled Non-autoclavable

- 0.30 mm to 0.50 mm (.012" to .020")
- Max. 0.56 mm x 0.71 mm (.022" x .028")



**DE-1354**  
Soft wire and ligature cutter, standard fitted with un-breakable, corrosion resistant and durable stainless steel tips

- ⌋ .25 mm to .38 mm (.010" to .015")



**PLIERS FOR ORTHODONTICS & PROSTHETICS**

- Щипцы для ортодонтии и протезирования
- Pincers pour l'orthodontie et la prothèse
- Zangen für Kieferorthopädie und Prothetik

- Щипці для ортодонції та протезування
- Alicates para ortodoncia y prótesis
- كمانشة لتقويم الأسنان بروتيسيس

**L-KEY JOINT PLIERS**



**DE-1360**  
Band removing pliers



**DE-1365**  
Weingart-mini  
Utility Pliers

- 0.30 mm to 0.50 mm (.012" to .020")
- Max 0.56 mm x 0.71 mm (.022" x .028")



**DE-1361**  
Bracket removing pliers angled



**DE-1366**  
Weingart  
Utility Pliers

- 0.30 mm to 0.50 mm (.012" to .020")
- Max 0.56 mm x 0.71 mm (.022" x .028")

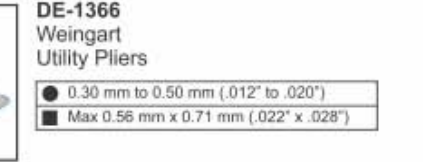

**DE-1362**  
Bracket removing pliers straight



**DE-1367**  
How Straight  
Utility Pliers

- 0.30 mm to 0.50 mm (.012" to .020")
- Max 0.56 mm x 0.71 mm (.022" x .028")



**DE-1363**  
Bracket removing pliers with plastic tip



**DE-1368**  
Angled  
Utility Pliers

- 0.30 mm to 0.50 mm (.012" to .020")
- Max 0.56 mm x 0.71 mm (.022" x .028")

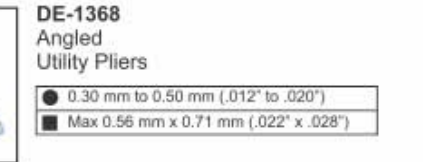

**DE-1364**  
Adhesive removing pliers



**DE-1369**  
Wire bending and loop forming pliers  
Angled (Bird beak)

- 0.30 mm to 0.50 mm (.012" to .020")
- Max 0.56 mm x 0.71 mm (.022" x .028")



**PLIERS FOR ORTHODONTICS & PROSTHETICS**

- Щипцы для ортодонтии и протезирования
- Pincers pour l'orthodontie et la prothèse
- Zangen für Kieferorthopädie und Prothetik
- Щипці для ортодонції та протезування
- Alicates para ortodoncia y prótesis
- كمشة لتقويم الأسنان بروستیتیس

**L-KEY JOINT PLIERS**



**DE-1370**  
Multi-purpose pliers, bird beak,  
De la rosa and cutter in one

- 0.30 mm to 0.50 mm (.012" to .020")
- Max. 0.46 mm x 0.56 mm (.018" x .022")



**DE-1375**  
Stop pliers V-Bebd - 1mm

- 0.30 mm to 0.50 mm (.012" to .020")
- Max. 0.43 mm x 0.56 mm (.017" x .028")



**DE-1371**  
Cinch Back / tie back  
Distal end bending pliers

- 0.30 mm to 0.50 mm (.012" to .020")
- Max. 0.56 mm x 0.71 mm (.022" x .028")



**DE-1376**  
Lingual / palatal arch forming plies

- 0.76 mm (.030") / 0.91 mm (.036")



**DE-1372**  
Hammer head  
Distal end bending pliers

- 0.30 mm to 0.50 mm (.012" to .020")
- Max. 0.56 mm x 0.71 mm (.022" x .028")



**DE-1377**  
Torquing pliers set



**DE-1373**  
Nance  
Loop forming pliers

- 0.36 mm to 0.71 mm (.014" to .028")
- Max. 0.56 mm x 0.71 mm (.022" x .028")



**DE-1378**  
Tweed / angel  
Rectangular arch forming and  
torquing pliers

- 0.30 mm to 0.71 mm (.012" to .028")
- Max. 0.56 mm x 0.71 mm (.022" x .028")



**DE-1374**  
Detailing step pliers / Bayonet  
bending pliers - 1mm

- 0.30 mm to 0.50 mm (.012" to .020")
- Max. 0.56 mm x 0.71 mm (.022" x .028")



**DE-1379**  
Surgical ball hook crimping pliers,  
angled



**DE-1380**  
Surgical ball hook crimping  
pliers, straight





PLIERS FOR ORTHODONTICS & PROSTHETICS

- Щипцы для ортодонтии и протезирования
- Щипці для ортодонтії та протезування
- Pincas pour l'orthodontie et la prothèse
- Alicates para ortodoncia y prótesis
- Zangen für Kieferorthopädie und Prothetik
- كمانشة لتقويم الأسنان بروسشيشيس

L-KEY JOINT PLIERS



**DE-1381**  
Aderer Clamp three jaw wire bending plier for contouring and bending wire up to .30"/.76mm.



**DE-1387**  
Falcon beak contouring plier.

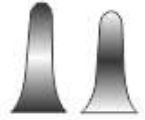

**DE-1382**  
Bird beak plier for bending round, square and rectangle wire up to .30"/.76mm.

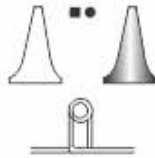

**DE-1388**  
For placement and removal of arch wires, pins and other auxiliaries.



**DE-1383**  
Bird beak plier for light wire bending round, square and rectangular up to .016"/0.41mm.

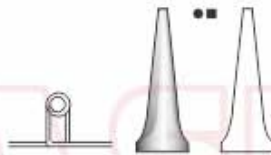

**DE-1389**  
For placement and removal of arch wires, pins and other auxiliaries in angle design



**DE-1384**  
Double Rounded jaw bending pliers, hooks and wire up to .020"/0.51mm.

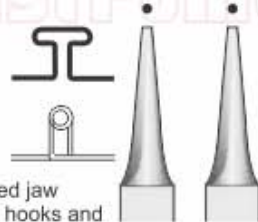

**DE-1390**  
contouring Plier.



**DE-1385**  
Adams pliers for hooks and bending wire up to .030"/0.76mm.



**DE-1391**  
Bending plier. In order to skirt molares bands. With grooved. Recommended wire. 016", 018" and 022" 0.41mm, 0.46mm and 0.56mm



**DE-1392**  
Loop forming in four length 3,4,5 & 6 mm wire capacity 0.22", 56mm.

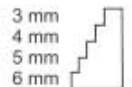

**DE-1386**  
Johnson pliers for crown band contouring



**DE-1393**  
Arch bending plier design for convenient handling of square or rectangular wire, .020" / 0.51mm.



**PLIERS FOR ORTHODONTICS & PROSTHETICS**

- Щипцы для ортодонтии и протезирования
- Pincers pour l'orthodontie et la prothèse
- Zangen für Kieferorthopädie und Prothetik
- Щипці для ортодонції та протезування
- Alicates para ortodoncia y prótesis
- كماناتة لتقويم الأسنان بروتستیس

**LAP & L-KEY JOINT PLIERS**



**DE-1394**  
In order to skirt bands and crowns.



**DE-1395**  
Wires up to .020" / 0.7mm.

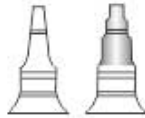

**DE-1396**  
Round and concave plier for loop forming and banding wire up to .20" / .051mm.



**DE-1397**  
Bending for round square or rectangular wire up to 0.30"/0.76mm



**DE-1398**  
for double back and triple back bands in 0.30" / .76mm & 0.36" / .91mm lingual arch wires.

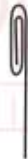

**DE-1399**  
Detailing step plier double-sided offset beak permits bayonet bends. Creates right hand or left hand step-up or stepdown at 1/2, 3/4, or 1mm increments.



**DE-1400**  
"V" bend stop special design makes 1mm "v" bends to shorten archwires or provide a positive stop. Excellent for placing stops in titanium wires. For round or rectangular wires up to .025"



**DE-1401**  
Angle how plier efficient utility plier with serrated beaks for a firm grip. 45 angled tips to access hard to reach areas.



**DE-1402**  
Weingardt plier serrated tips hold wires firmly at a convenient working angle. Tapered beaks fit easily between brackets and hard to reach areas. Our most popular utility plier.



**DE-1415**  
Pin & Ligature Cutters TC.



**DE-1416**  
Mini Pin & Ligature Cutter TC.



**DE-1417**  
Standard Ligature Cutter TC.



**DE-1418**  
V Bend Stop Plier TC.



**DE-1419**  
Angled Direct Bond Bracket Remover TC.



**DE1-1419**  
Cutter Str.



Distal Cutter  
14cm  
**DE2-1419** 2.5 mm  
**DE3-1419** 3.0 mm  
**DE4-1419** 3.0 mm



**DE5-1419**  
Arrow Clasp Forming Pliers  
12.0cm



**DE6-1419**  
Schwarz  
12.5cm



DISTAL END, WIRE CUTTERS & BRACKET REMOVER PLIERS



**DE-1420**  
Distal end Cutter, Safety Hold Plier  
(Ideal for Cutting Wire) TC.



**DE-1421**  
Hook Crimping Plier Angled  
Straight TC.



**DE-1422**  
3 Prong Clasp Adjustable  
Plier TC.



**DE-1423**  
Utility Plier Weingart TC.



**DE-1424**  
Direct Bracket Remover  
TC.



**DE-1425**  
Straight Direct Bond Bracket  
Remover TC.



**DE-1426**  
Pin Holding Plier TC.



**DE-1427**  
Hard wire cutters



**DE-1428**  
Elastic Separating Plier  
Round Handle



**DE-1429**  
Elastic  
Separating Plier



**DE-1430**  
**DE-1431**  
Smaha  
Elastomeric  
ligature  
placing forceps  
140 mm



**DE-1432**  
Elastomeric  
ligature placing  
forceps with  
groove  
Falcon 140 mm



**DE-1433**  
Elastomeric  
ligature placing  
forceps with  
groove  
Falcon 140 mm



# Normal Anatomy – Dental Implants

Bone Level Normal  
(No Bone Loss)

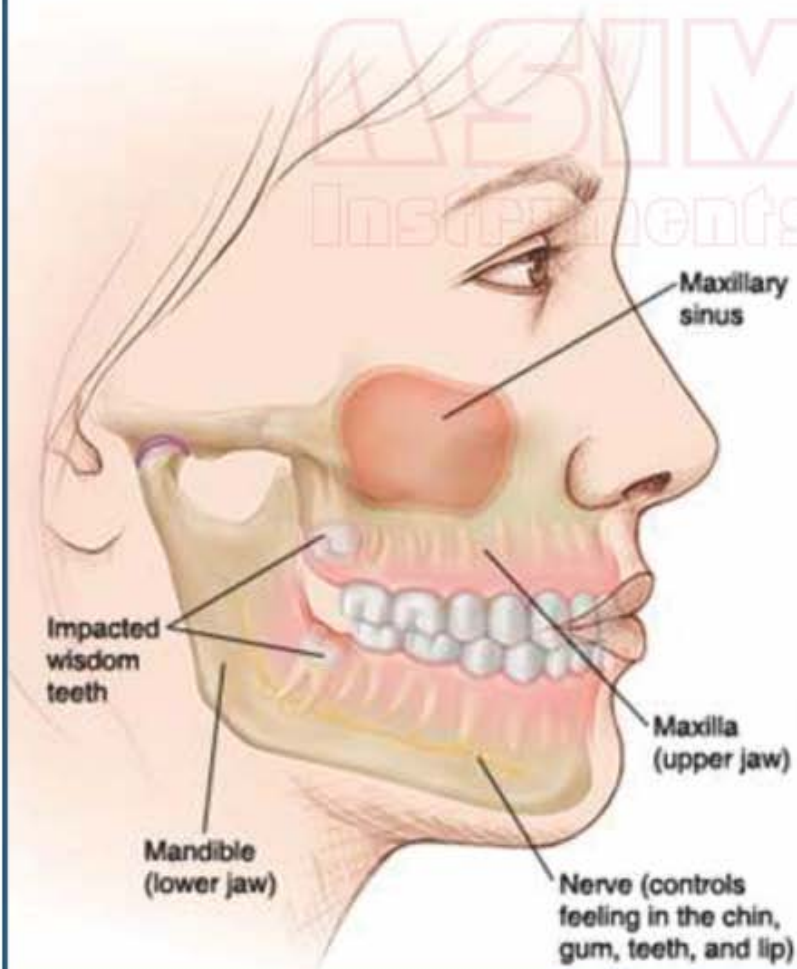
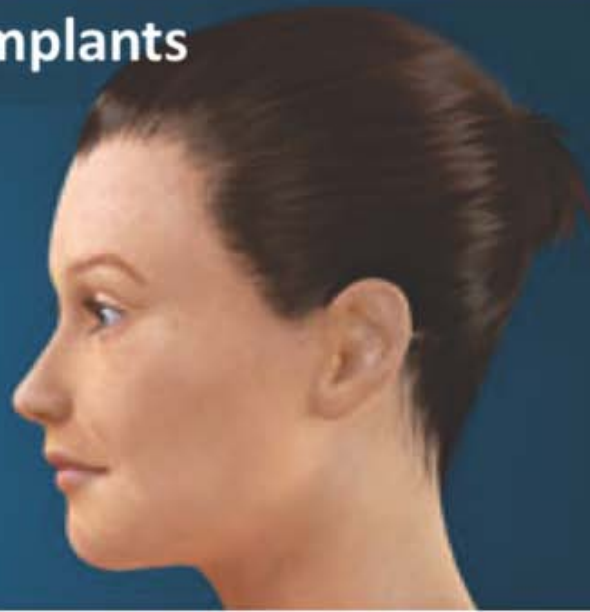

- Инструменты для имплантологии
- Implantologie
- Implantologie

- Інструменти для імплантології
- Implantologia
- زراعة الأسنان

IMPLANT GAGES

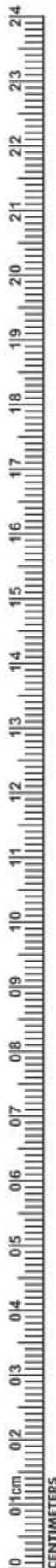

**DE-1434 Multifunctional Meter**  
Length 90 mm, different sizes, 8-10-11mm, corrosion-resistant

**DE-1435 Multifunctional Meter**  
Length 90 mm, different sizes, 5-13-15-17 mm, corrosion-resistant

**DE-1436 Measuring Probe**  
Length 170 mm, hand shape or flexible (6-8-10-14-16 mm), corrosion-resistant

**DE-1437**

**DE-1438**

**DE-1439**

**DE-1440**

IMPLANT GAGES



**DE-1441**

**DE-1442**

**DE-1443**

**IMPLANTOLOGY**

- Инструменты для имплантологии
  - Implantologie
  - Implantologie
- Інструменти для імплантології
  - Implantoloia
  - زراعة الأسنان



**DE-1444**  
Clamp, Osteometer  
Length about 155 mm,  
ridge width measurement,  
two-sided scale,  
measuring  
range 0 - 25 mm



**DE-1445**  
Measuring Loop  
straight length 90 mm,  
measuring range  
0 - 40 mm,



**DE-1446**  
Measuring Loop  
angled, length 90 mm,  
measuring range  
0 - 40 mm,



**DE-1447**  
Measuring loop, Castroviejo  
angled, length 175 mm,  
measuring range 0 - 40 mm,  
with window



**DE-1448**  
Boley Gauge  
Stainless Steel



**DE-1449**  
Measuring Loop  
angled, length  
175 mm,  
measuring range  
0 - 40 mm,



**DE-1450**  
Measuring Loop  
straight length  
175 mm,  
measuring range  
0 - 40 mm,



**DE-1451**  
Fig. 1  
Iwanson  
spring caliper  
For metal and  
porcelain.



**DE-1452**  
Fig. 2  
Iwanson  
spring caliper  
For wax.



**DE-1453**  
Bone Thickness Gauge  
40mm, 180mm



**DE-1454**  
Gauge  
for measuring  
distances  
(0 - 90 mm),



- Инструменты для имплантологии
  - Implantologie
  - Implantologie
- Інструменти для імплантології
  - Implantologia
  - زراعة الأسنان

BLACK TITANIUM COLOUR COATED INSTRUMENTS

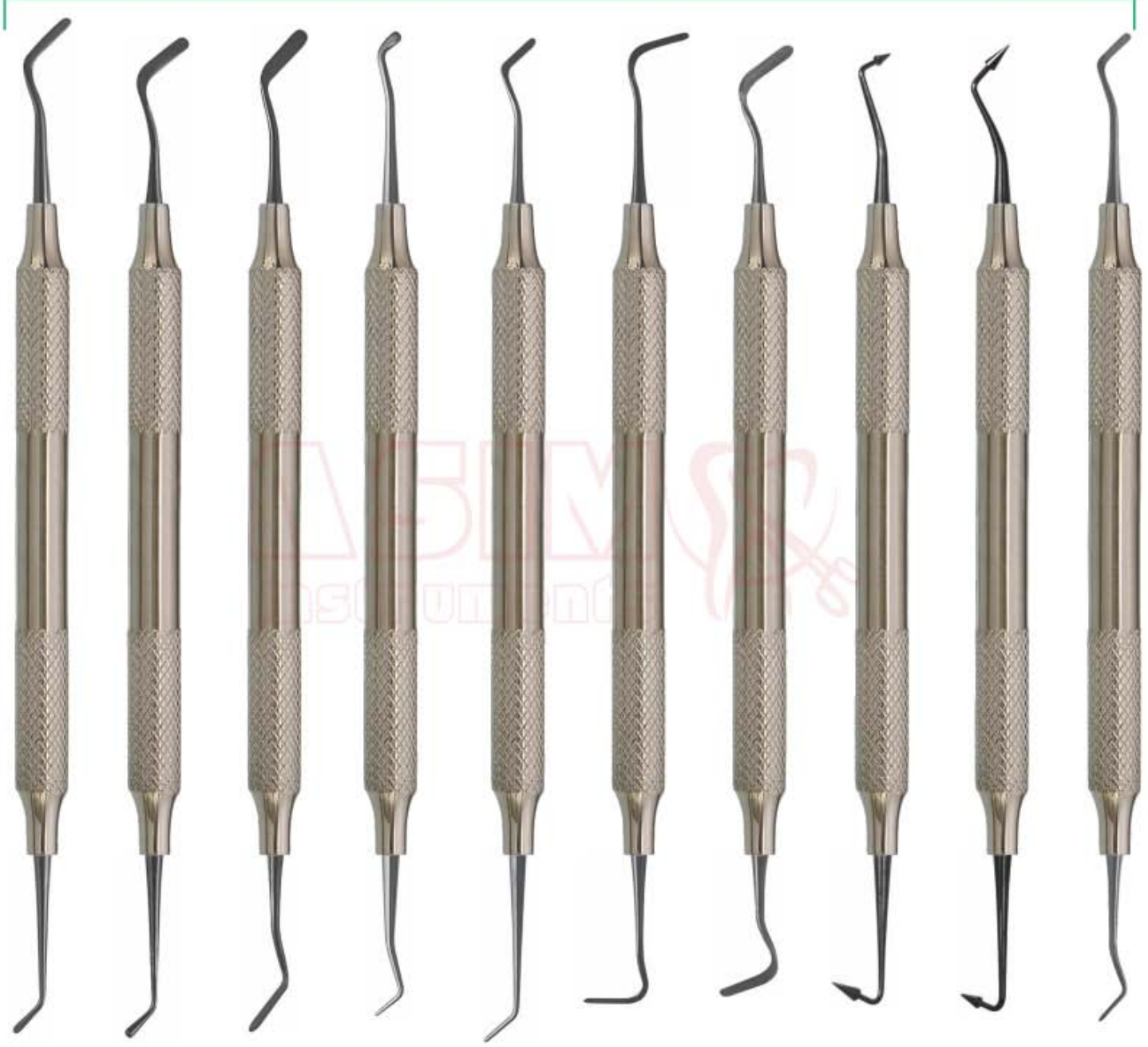

DE-1455 #1	DE-1456 #2	DE-1457 #3 Extra-Flex	DE-1458 Micro-Mini	DE-1459 Mini 1	DE-1460 Mini 4 Extra-Flex	DE-1461 #4 Extra-Flex	DE-1462 #5 Flexi-Thin	DE-1463 #6 Flexi-Thin	DE-1464 Mini 3 Extra-Flex
---------------	---------------	-----------------------------	-----------------------	-------------------	---------------------------------	-----------------------------	-----------------------------	-----------------------------	---------------------------------

IMPLANTOLOGY

- Инструменты для имплантологии
- Implantologie
- Implantologie
- Инструменти для імплантології
- Implantologia
- زراعة الأسنان

BLACK TITANIUM COLOUR COATED INSTRUMENTS

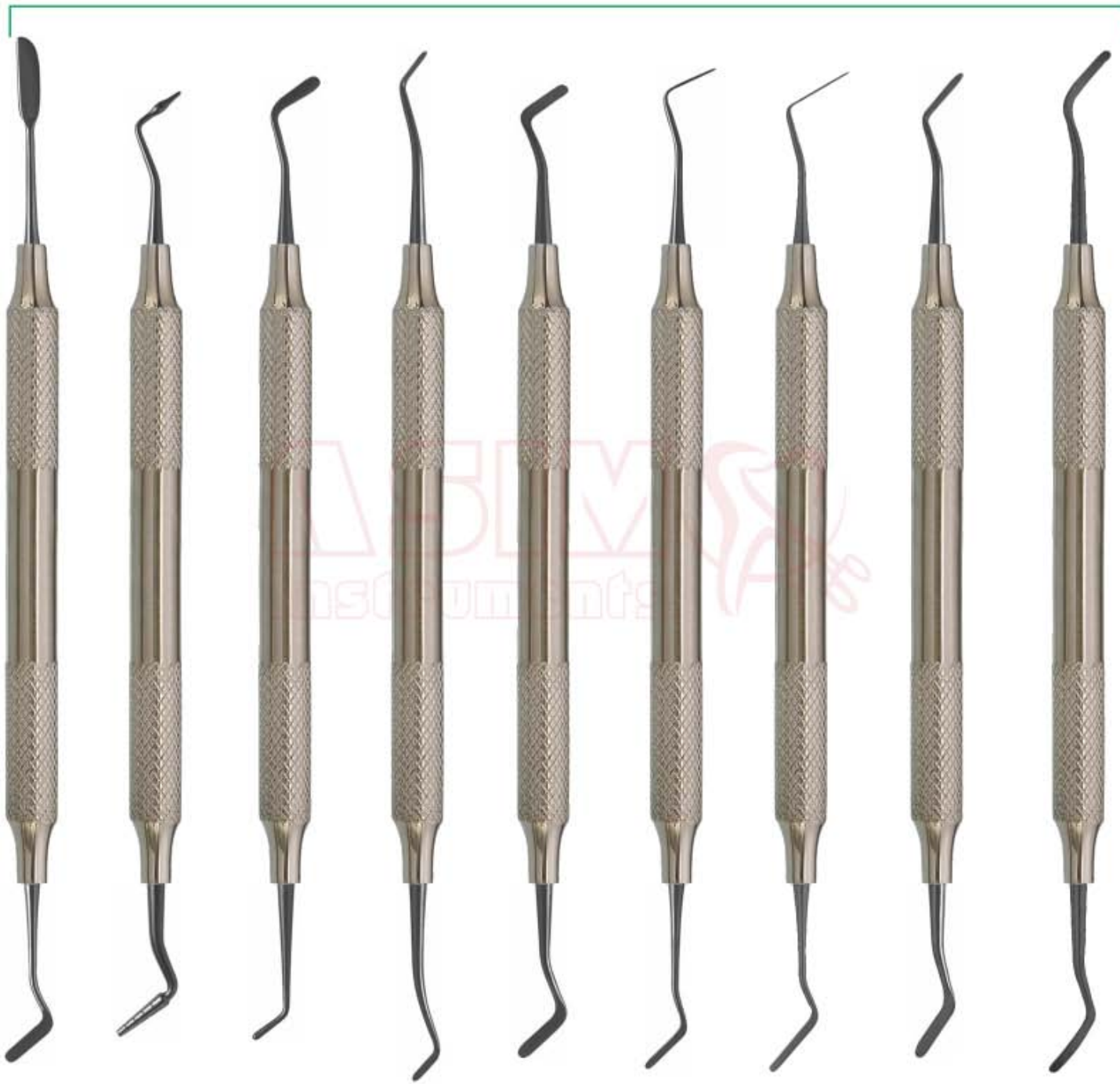

DE-1465  
AB1  
Boghosian

DE-1466  
AB2  
Boghosian

DE-1467  
W3

DE-1468  
8A

DE-1469  
4/5  
Gregg

DE-1470  
Interproximal  
Carver

DE-1471  
Interproximal  
Carver, Long

DE-1472  
A6

DE-1473  
Contouring  
instrument



- Инструменты для имплантологии
  - Implantologie
  - Implantologie
- Інструменти для імплантології
  - Implantologia
  - زراعة الأسنان

BLACK TITANIUM COLOUR COATED INSTRUMENTS

BURNISHERS

FREEDMAN BURNISHERS

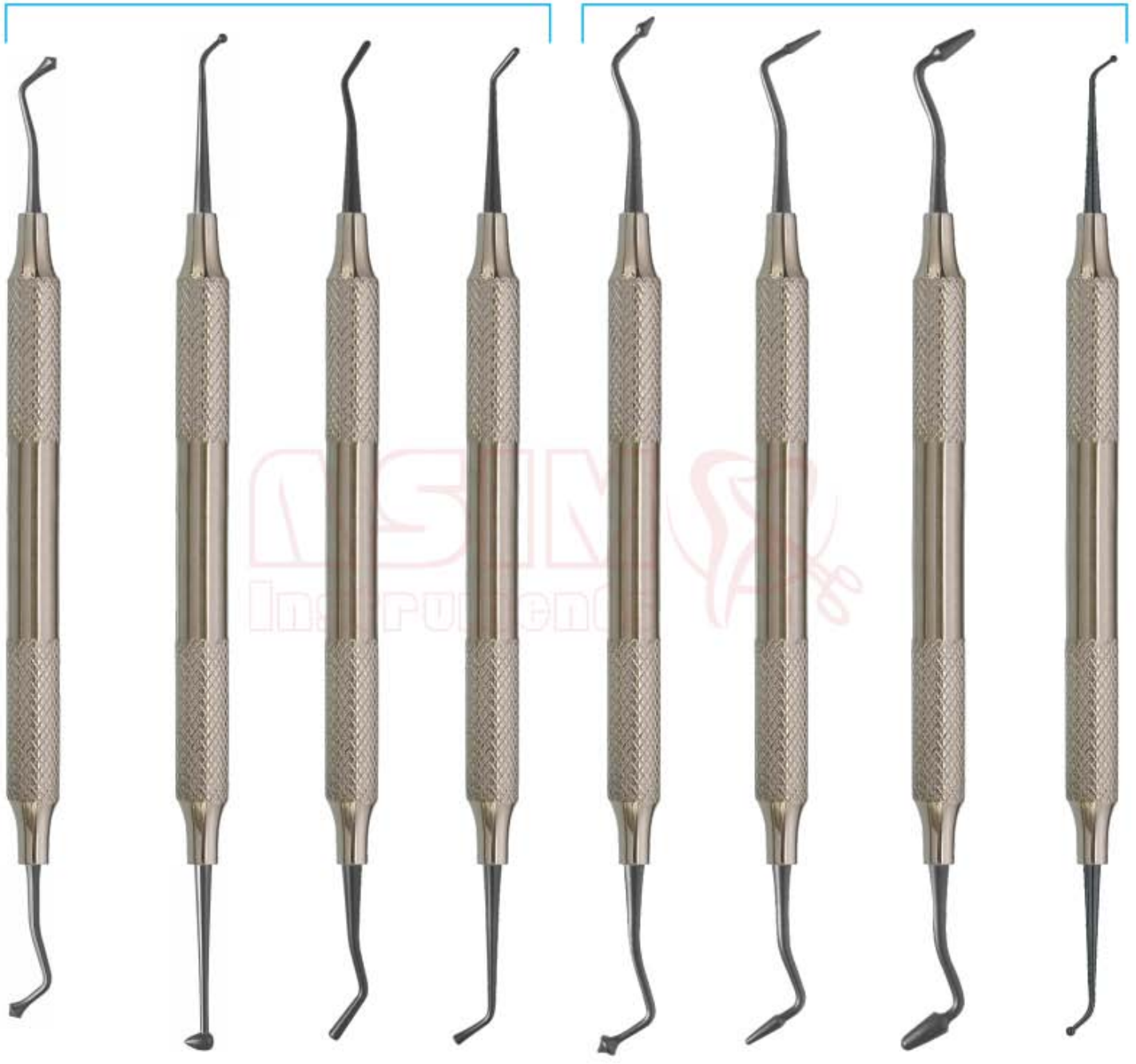

DE-1474  
21B

DE-1475  
27/29

DE-1476  
2  
Ladmore

DE-1477  
3  
Ladmore

DE-1478  
Freedman  
"Duckhead"

DE-1479  
Freedman  
Small Contact  
Forming

DE-1480  
Freedman  
Large Contact  
Forming

DE-1481  
Small/  
Medium Ball  
Burnisher

**IMPLANTOLOGY**

- Инструменты для имплантологии
- Implantologie
- Implantologie
- Інструменти для імплантології
- Implantoloia
- زراعة الأسنان

**BLACK TITANIUM COLOUR COATED INSTRUMENTS**

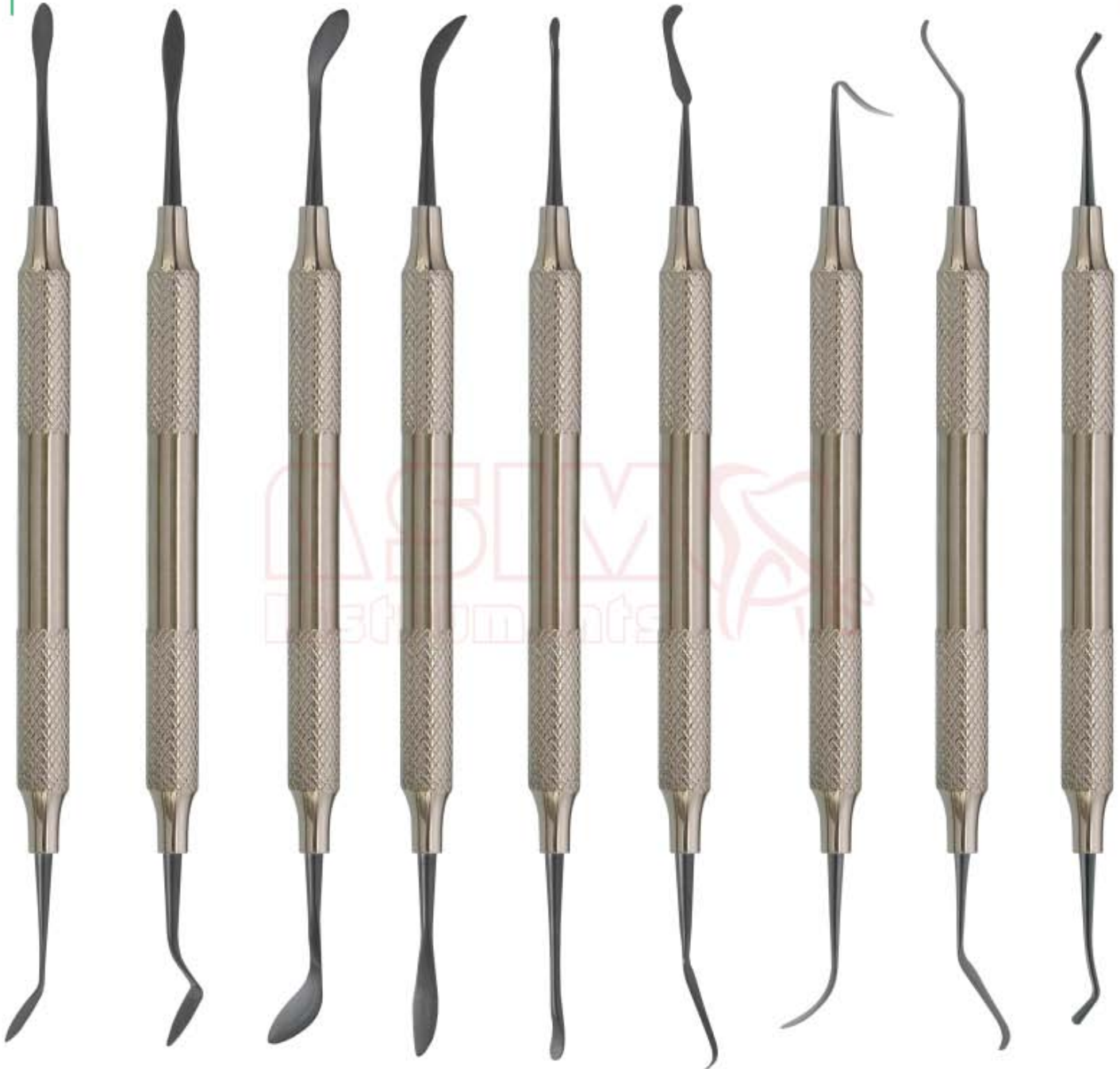

**DE-1482**  
A  
Cosmetic  
Contouring

**DE-1483**  
B  
Cosmetic  
Contouring

**DE-1484**  
C  
Cosmetic  
Contouring

**DE-1485**  
D  
Cosmetic  
Contouring

**DE-1486**  
E  
Cosmetic  
Contouring

**DE-1487**  
F  
Cosmetic  
Contouring

**DE-1488**  
Marginal Ridge  
& Embrasure  
Shaping Instrument

**DE-1489**  
Occlusal  
Anatomy  
Instrument

**DE-1490**  
Composite  
Packing  
Instrument



- Инструменты для имплантологии
  - Implantologie
  - Implantologie
- Інструменти для імплантології
  - Implantologia
  - زراعة الأسنان

BLACK TITANIUM COLOUR COATED INSTRUMENTS

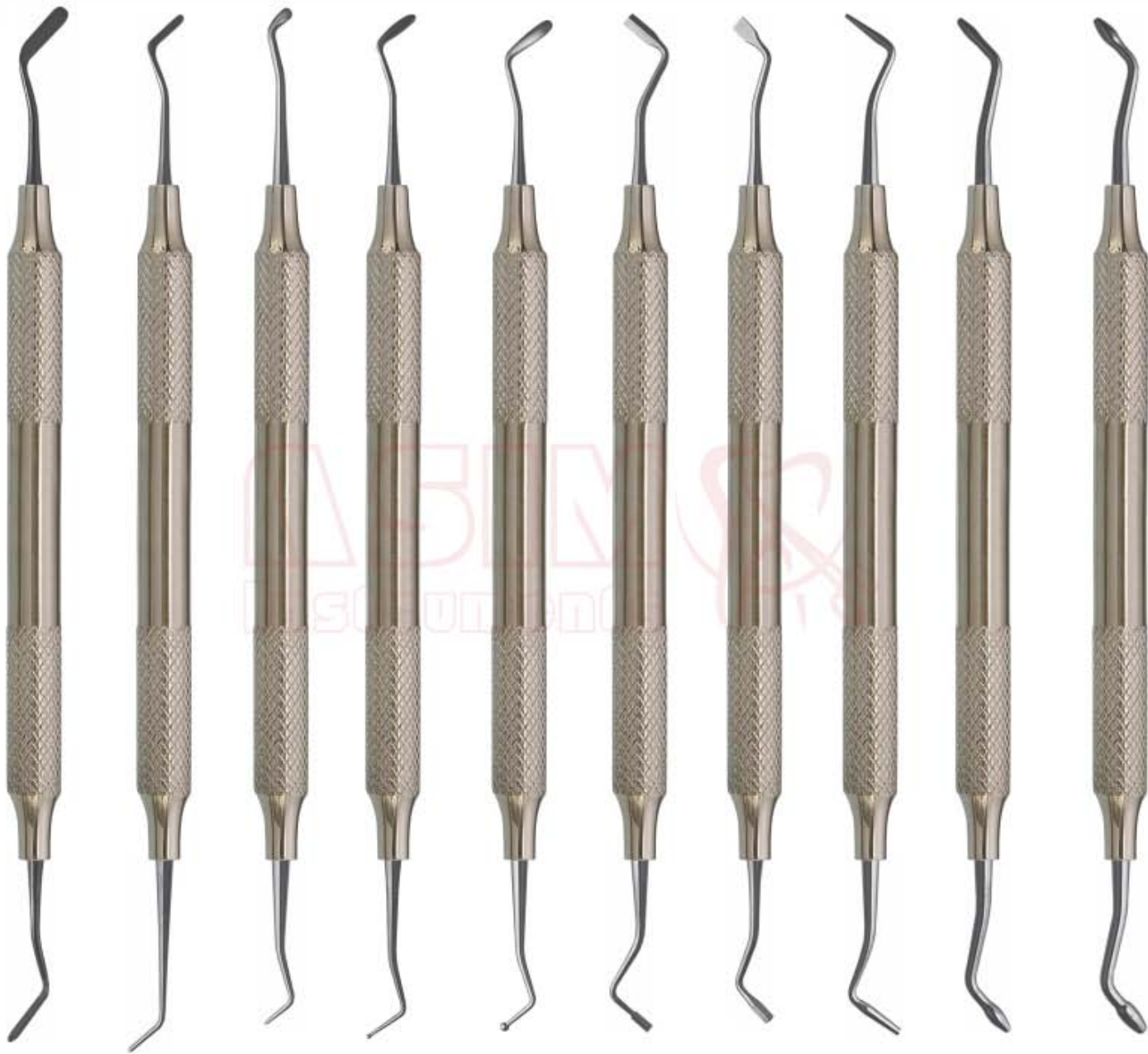

<p><b>DE-1491</b> #3 Extra-Flex</p>	<p><b>DE-1492</b> Mini 1</p>	<p><b>DE-1493</b> Micro-Mini</p>	<p><b>DE-1494</b> Medium Placing/ Condensing</p>	<p><b>DE-1495</b> Large Placing/ Condensing</p>	<p><b>DE-1496</b> OT Tanner</p>	<p><b>DE-1497</b> 3 Hollenback</p>	<p><b>DE-1498</b> 5A</p>	<p><b>DE-1499</b> Small/Medium Contact Forming</p>	<p><b>DE-1500</b> Medium/Large Contact Forming</p>
---	----------------------------------	--------------------------------------	--	---	---	--	------------------------------	--	--

# IMPLANTOLOGY

- Инструменты для имплантологии
- Instrumentologie
- Implantologie
- Інструменти для імплантології
- Implantoloia
- زراعة الأسنان

## SINUS LIFT INSTRUMENTS HOLLOW HANDLE 9.5MM LENGTH 170MM



DE-1501  
Sinus Lift Elevator

DE-1502  
Sinus Lift Elevator

DE-1503  
Sinus Lift Elevator

DE-1504  
Sinus Lift Elevator

DE-1505  
Sinus Lift Elevator



- Инструменты для имплантологии
- Implantologie
- Implantologie
- Інструменти для імплантології
- Implantologia
- زراعة الأسنان

SINUS LIFT INSTRUMENTS HOLLOW HANDLE 9.5MM LENGTH 170MM



DE-1506  
Sinus Lift Elevator

DE-1507  
Sinus Lift Elevator

DE-1508  
Sinus Lift Elevator

DE-1509  
Sinus Lift Elevator



IMPLANTOLOGY

- Инструменты для имплантологии
- Implantologie
- Implantologie
- Інструменти для імплантології
- Implantologia
- زراعة الأسنان

IMPLANT SINUS LIFT INSTRUMENTS HOLLOW HANDLE 9.5MM LENGTH 170MM



DE-1510  
Acute 6577

DE-1511  
Sinus1

DE-1512  
Sinus2

DE-1513  
Sinus3,  
Obtuse 6578

DE-1514  
Sinus4

DE-1515  
Sinus5

DE-1516  
Sinus6

DE-1517  
Sinus7



- Инструменты для имплантологии
- Implantologie
- Implantologie
- Инструменти для імплантології
- Implantologia
- زراعة الأسنان

SINUS LIFT INSTRUMENTS HOLLOW HANDLE 9.5MM LENGTH 170MM

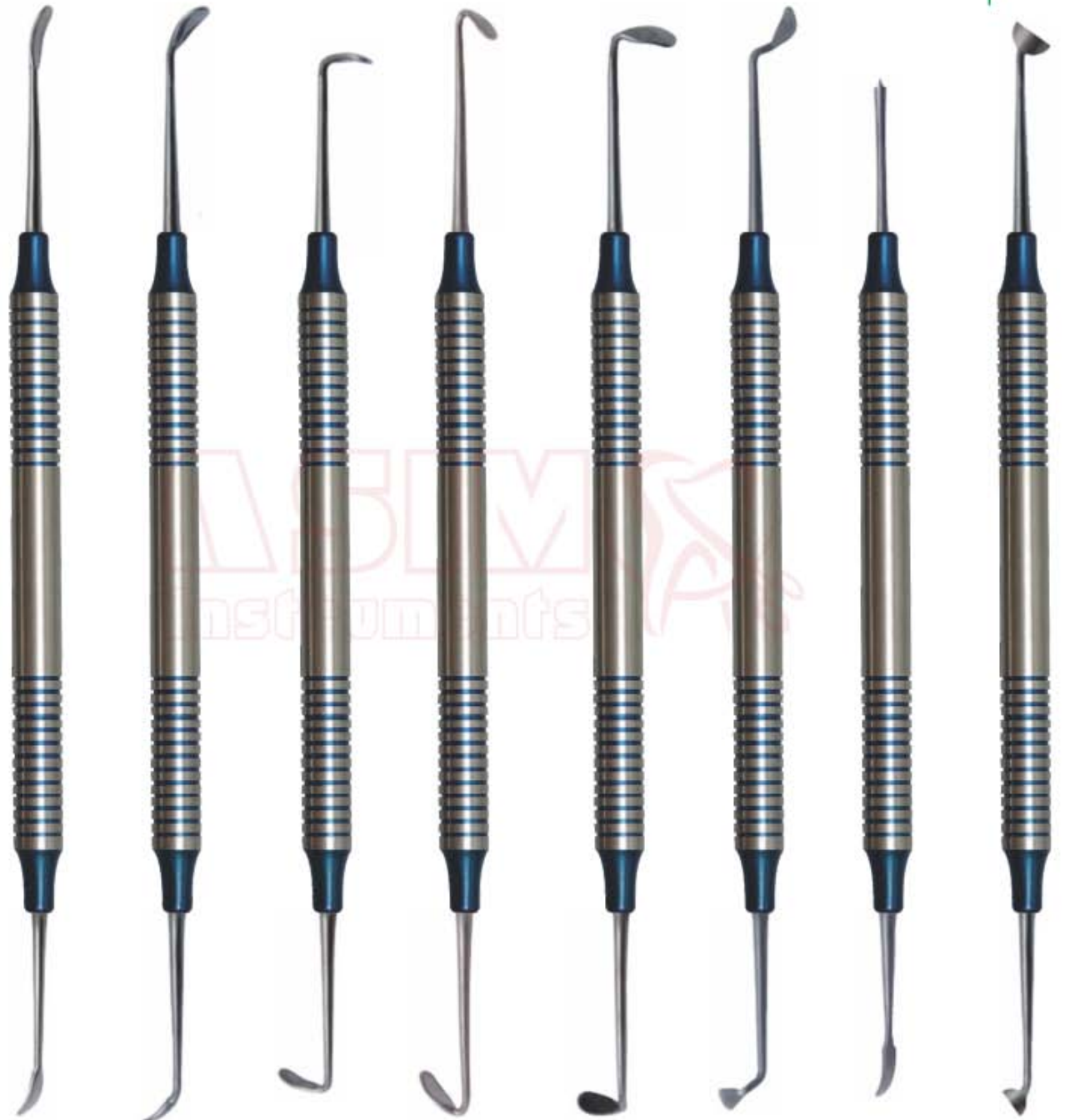

DE-1518  
Sinuslift 1

DE-1519  
Sinuslift 2

DE-1520  
Sinuslift 3

DE-1521  
Sinuslift 4

DE-1522  
Sinuslift 5

DE-1523  
Sinuslift 6

DE-1524  
Membrane  
3Positioning 1

DE-1525  
Condenser 1

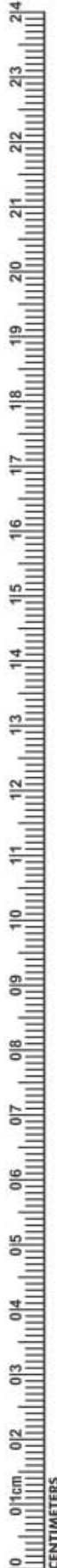

**IMPLANTOLOGY**

- Инструменты для имплантологии
- Implantologie
- Implantologie
- Інструменти для імплантології
- Implantologia
- زراعة الأسنان

**Sinus Lift Instrument,**  
Flexible Sinus Lift instruments  
reduce the risk of perforation of the  
"Schneider's membrane"

**Sinus Lift Elevator,**  
10 mm Straight grip  
Length 175 mm, Sinus lift elevators, dull,  
for gentle peeling and lifting the  
Schneider membrane

**Sinus lift instrument**  
10 mm Straight grip Length 180 mm,  
Buser (B1, B2, B3) raspatories,  
quality medical stainless steel,  
corrosion-resistant

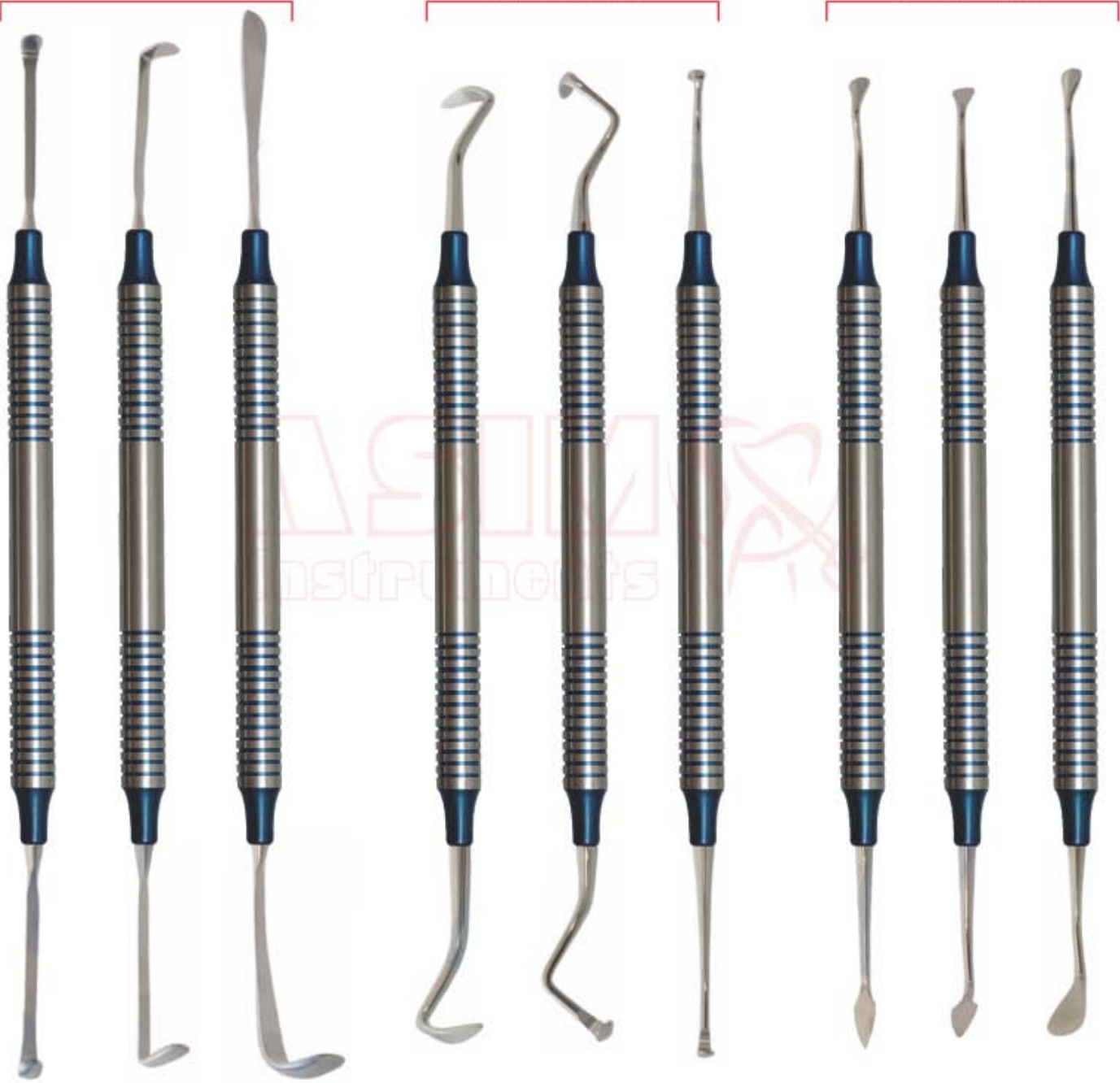

DE-1526  
Fig. 1

DE-1527  
Fig. 2

DE-1528  
Fig. 3

DE-1529  
Fig. 1

DE-1530  
Fig. 2

DE-1531  
Fig. 3

DE-1532  
B01

DE-1533  
B02

DE-1534  
B03





- Инструменты для имплантологии
  - Implantologie
  - Implantologie
- Інструменти для імплантології
  - Implantologia
  - زراعة الأسنان

Sinus lift instrument 10 mm Straight grip Sinus lift elevators, blunt or sharply curved (H01, H02, K03, K04, K78, K77)

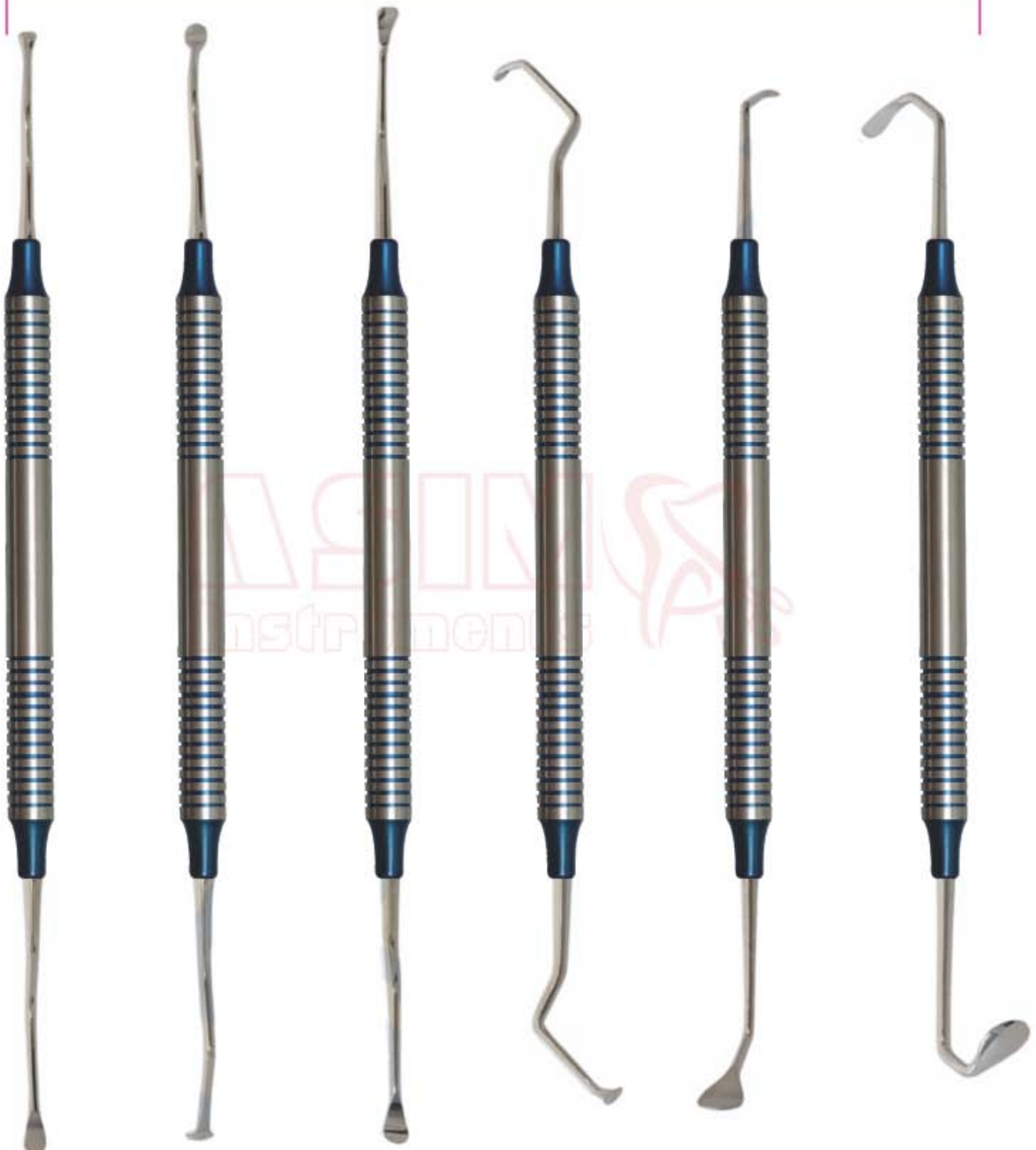

**DE-1535**  
Sinus lift instrument H01

**DE-1536**  
Sinus lift instrument H02

**DE-1537**  
Sinus lift instrument K03

**DE-1538**  
Sinus lift instrument K04

**DE-1539**  
Sinus lift instrument K78

**DE-1540**  
Sinus lift instrument K77



# IMPLANTOLOGY

- Инструменты для имплантологии
- Implantologie
- Implantologie
- Інструменти для імплантології
- Implantologia
- زراعة الأسنان

## SINUS LIFT INSTRUMENT

Sinus Lift Elevators, 10 mm Hollow Handle length 170mm Blunt Curved Set of 6 Pcs



- Инструменты для имплантологии
- Implantologie
- Implantologie

- Інструменти для імплантології
- Implantologia
- زراعة الأسنان

IMPLANT SINUS LIFT INSTRUMENTS  
 PERIODONTAL SURGERY    SURGICAL CHISELS  
 KRAMER NEVINS SINUS LIFT

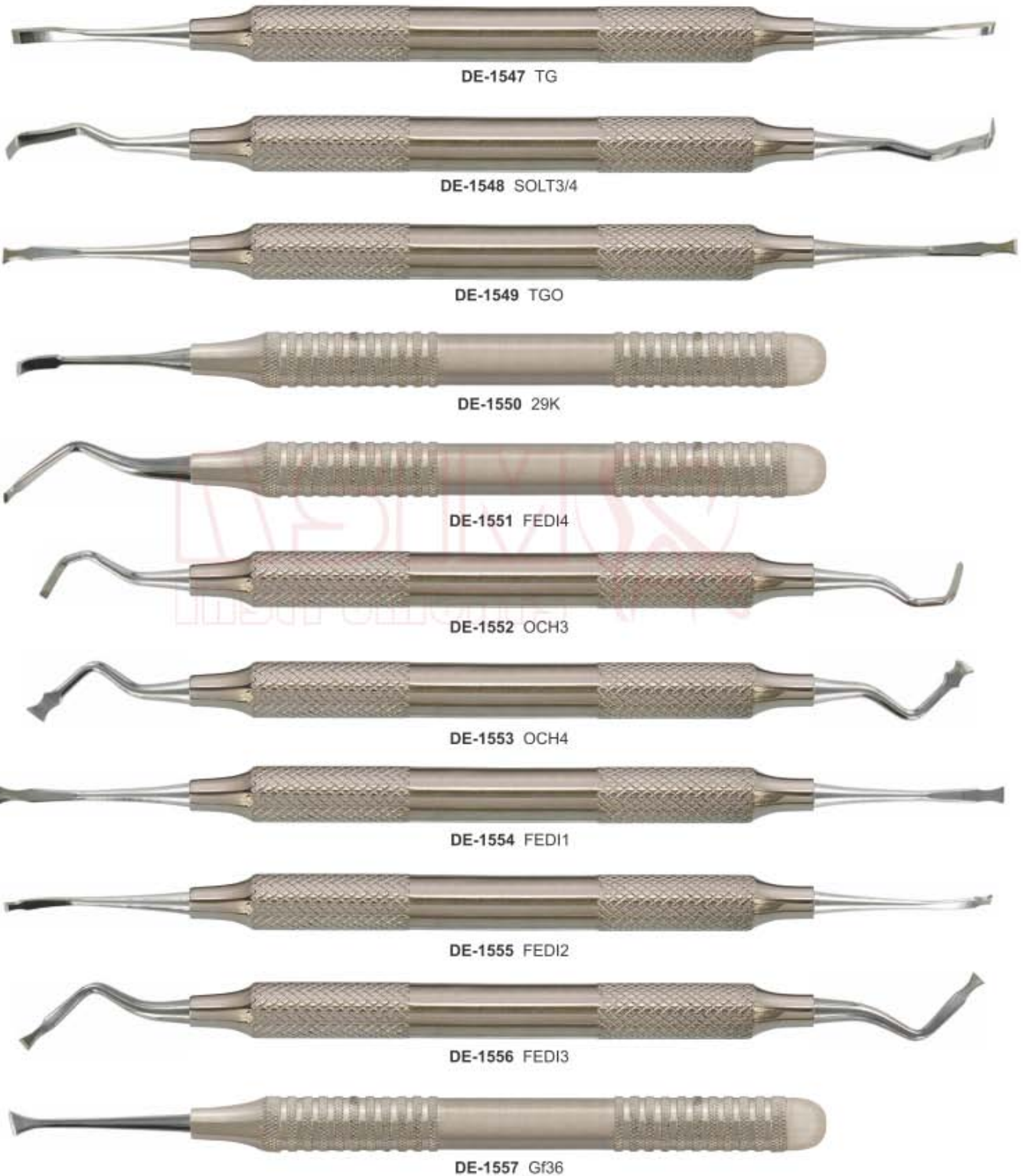

**IMPLANTOLOGY**

- Инструменты для имплантологии
- Implantologie
- Implantologie
- Інструменти для імплантології
- Implantoloia
- زراعة الأسنان

**IMPLANT**

**SURGICAL CHISELS**

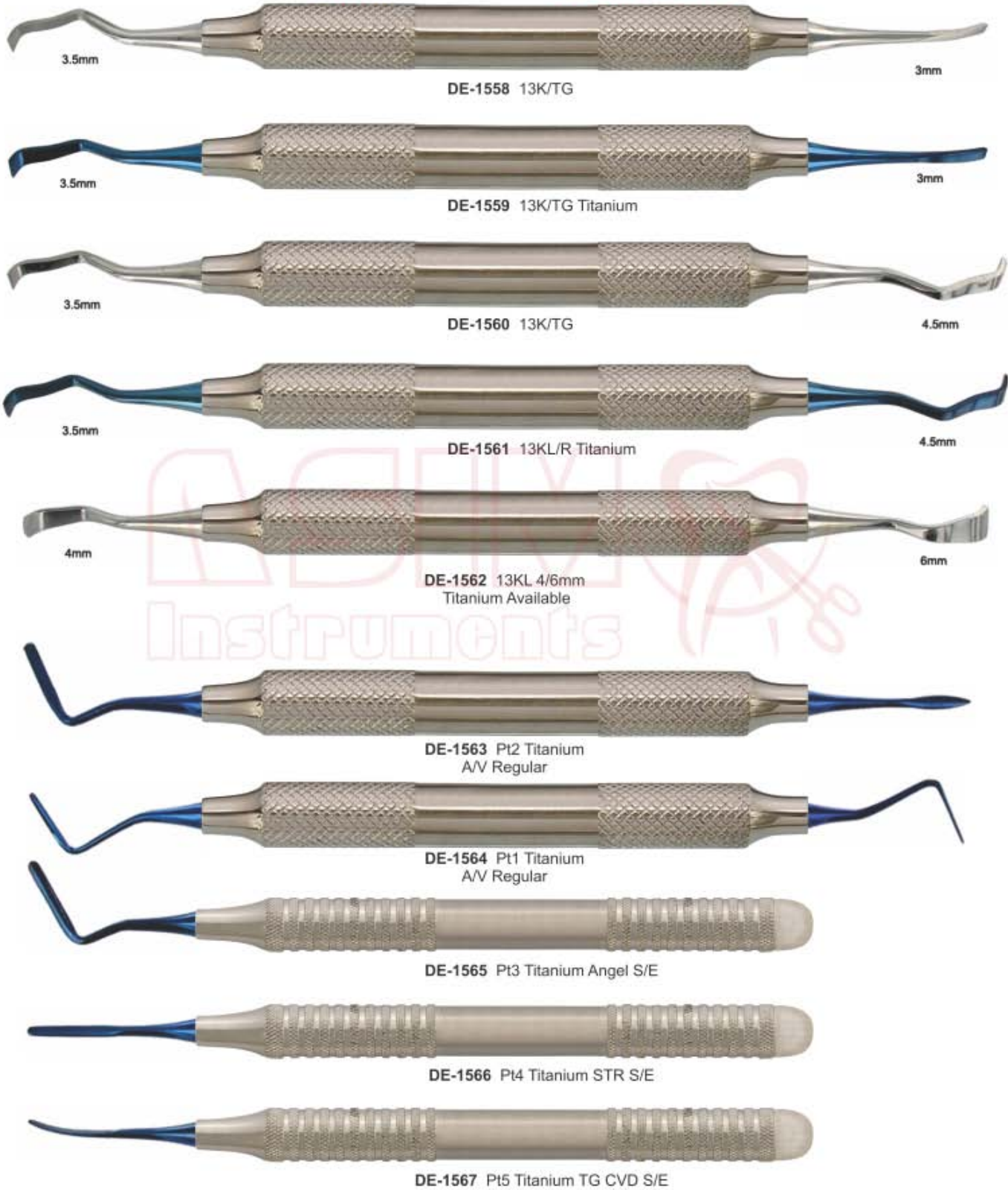

3.5mm

DE-1558 13K/TG

3mm

3.5mm

DE-1559 13K/TG Titanium

3mm

3.5mm

DE-1560 13K/TG

4.5mm

3.5mm

DE-1561 13KL/R Titanium

4.5mm

4mm

DE-1562 13KL 4/6mm  
Titanium Available

6mm

DE-1563 Pt2 Titanium  
A/V Regular

DE-1564 Pt1 Titanium  
A/V Regular

DE-1565 Pt3 Titanium Angel S/E

DE-1566 Pt4 Titanium STR S/E

DE-1567 Pt5 Titanium TG CVD S/E

INCHES

- Инструменты для имплантологии
- Implantologie
- Implantologie
- Инструменти для імплантології
- Implantologia
- زراعة الأسنان

MIXING SPATULA WITH SHOVEL



**DE-1568**  
Bone Carrier  
Titanium



**DE-1569**  
Raspator, Prichard  
Length 180 mm,  
10 mm hollow handle,  
double-ended  
10.5 mm | 4.5 mm,



**DE-1570**  
Raspator, Prichard  
Length 180 mm,  
10 mm hollow handle,  
double ended



**DE-1571**  
Raspator, Prichard  
Length 180 mm,  
10 mm hollow handle,  
double-ended  
10.5 mm | 4.5 mm,



**DE-1572**  
Mixing Spatula  
with shovel  
17cm



**DE-1573**  
Mixing Spatula  
with shovel  
18.5cm



**IMPLANTOLOGY**

- Инструменты для имплантологии
- Implantologie
- Implantologie
- Інструменти для імплантології
- Implantologia
- زراعة الأسنان

**BONE GRAFTING INSTRUMENTS COMPACTOR /TAMPERS**

Product offering includes instruments for harvesting, mixing and compacting bone Provides clinicians with the proper instrumentation for bone grafting procedures Weighted bone basin Prevents tipping and spilling of bone and other materials during mixing



**DE-1574**  
Graft Packer,  
Concave Tips  
DE 4/6mm

**DE-1575**  
Bone Spoon/  
Packer DE 3mm

**DE-1576**  
Graft Packer,  
Serrated Tips  
DE 6/8mm

**DE-1577**  
Graft Packer,  
Serrated Tips  
DE 3/4mm

**DE-1578**  
Graft Packer,  
Smooth Tips  
DE 5/8mm

**DE-1579**  
Titanium graft packer/  
placement site depth  
gauge 3.3mm & 4.0mm  
Diameter tips Marked  
at 8, 11, 13, 15 & 18mm

**DE-1580**  
Graft Material Spoon  
Concave Tip For  
Larger Grafts

- Инструменты для имплантологии
- Implantologie
- Implantologie
- Инструменти для імплантології
- Implantologia
- زراعة الأسنان

BONE GRAFTING INSTRUMENTS



**DE-1581**  
Blade and pusher  
Length 180 mm,  
for straight or angled,  
blade: 15 x 5 mm,  
pusher: 4 mm diameter  
Straight



**DE-1582**  
Blade and pusher  
Length 180 mm,  
for straight or angled,  
blade: 15 x 5 mm,  
pusher: 4 mm diameter  
angular



**DE-1583**  
Spoon and pusher  
Length 180 mm,  
for angled spoon:  
10 x 5 mm, pusher:  
diameter 3 mm



**DE-1584**  
Tunnelierungs  
Instrument  
length 175 mm,



**DE-1585**  
Tunnelierungs  
Instrument  
length 175 mm,  
different designs



**DE-1586**  
Tampers  
Length 170 mm,  
for bone material,  
double-ended,  
diameter 3.2 mm  
(2-4-6-8-10) and diameter  
2.5mm (2-4-6-8-10)



**IMPLANTOLOGY**

- Инструменты для имплантологии
- Implantologie
- Implantologie
- Инструменти для імплантології
- Implantologia
- زراعة الأسنان

**Pluggers Clarizio**

Length 160 mm, with titanium tips for mixing and pouring of autologous, heterologous bone substitute material, diameter (3/4 or 6/8 mm)

**BONE GRAFTING INSTRUMENTS**



DE-1587 Ø 4mm  
DE-1588 Ø 5mm  
Compactor  
150mm



DE-1589  
Sinus Window  
Bone Tampers  
4 mm



DE-1590  
Sinus Window  
Bone Tampers  
7 mm



DE-1591  
6/8mm



DE-1592  
3/4mm





- Инструменты для имплантологии
  - Implantologie
  - Implantologie
- Інструменти для імплантології
  - Implantoloia
  - زراعة الأسنان

**SPOON AND PUSHER (TRINOVO)**

Trinovo handle, different workers, for bone material, high-grade medical stainless steel, corrosion-resistant

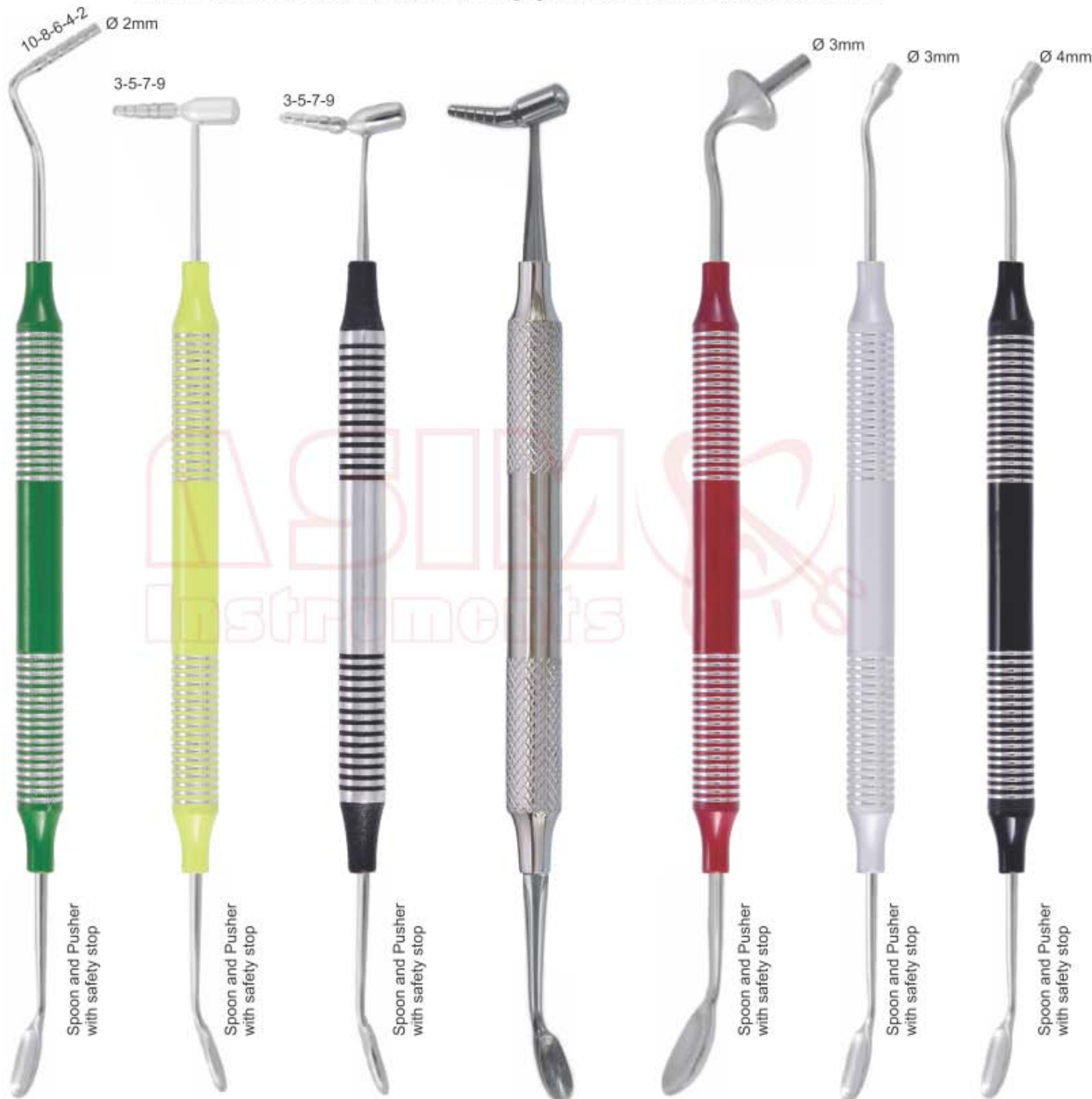
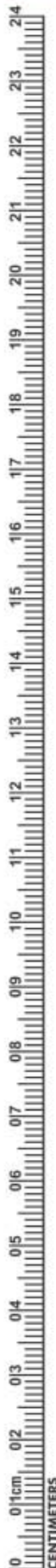

**DE-1593**  
10x5mm

Spoon and Pusher  
with safety stop

**DE-1594**  
10x5mm

Spoon and Pusher  
with safety stop

**DE-1595**  
10x5mm

Spoon and Pusher  
with safety stop

**DE-1596**  
Bone Graft/Carrier  
Titanium  
2-4-6-8-10mm

**DE-1597**  
15x10mm

Spoon and Pusher  
with safety stop

**DE-1598**  
10x5mm

Spoon and Pusher  
with safety stop

**DE-1599**  
10x5mm

Spoon and Pusher  
with safety stop

**IMPLANTOLOGY**

- Инструменты для имплантологии
- Implantologie
- Implantologie
- Инструменти для імплантології
- Implantologia
- زراعة الأسنان

**PERIOSTEALS ELEVATOR 10mm Hollow Handle**



**DE-1600**  
Raspator,  
BonexScraper  
Length 165 mm,  
10 mm hollow  
handle,  
double-ended 6  
mm / 4 mm,

**DE-1601**  
Raspator,  
Raspatory  
Length 180 mm,  
10 mm hollow  
handle,  
double-ended  
3 mm | 3 mm,

**DE-1602**  
Raspator,  
Raspatory  
Length 180 mm,  
10 mm hollow  
handle,  
double-ended  
3 mm | 3 mm,

**DE-1603**  
Raspator,  
Papilla  
Length 185 mm,  
10 mm hollow  
handle,  
double-ended  
3 mm | 2 mm,

**DE-1604**  
Raspator,  
bone scraper  
Length 175 mm,  
10 mm hollow  
handle,  
double-ended,

**DE-1605**  
Raspator,  
micro-Freer  
Length 180 mm,  
6 mm solid grip,  
double-ended  
3 mm | 4 mm

**DE-1606**  
Raspator,  
Freer  
Length 180 mm,  
6 mm solid  
handle,  
double-ended  
5 mm | 5 mm,



- Инструменты для имплантологии
  - Implantologie
  - Implantologie
- Інструменти для імплантології
  - Implantologia
  - زراعة الأسنان

PERIOSTEALS ELEVATOR 10mm Hollow Handle

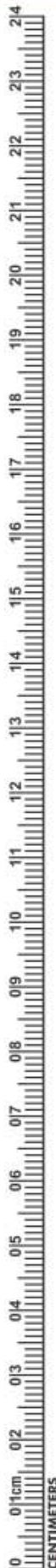

**DE-1607**  
Raspator,  
Freer  
10 mm hollow  
handle,  
high-quality  
medical  
double ended

**DE-1608**  
Raspator,  
Molt  
Length 180 mm,  
8 mm solid  
grip,  
double-ended  
6 mm

**DE-1609**  
Raspator,  
micro Freer  
Length 185 mm,  
10 mm hollow  
handle,  
double-ended,

**DE-1610**  
Raspator,  
micro Freer  
Length 185 mm,  
10 mm hollow  
handle,  
double-ended,

**DE-1611**  
Raspator, micro  
Raspator /  
chisel  
Length 170 mm,  
10 mm hollow  
handle,  
double-ended,

**DE-1612**  
Raspator, micro  
Raspator /  
chisel  
Length 175 mm,  
10 mm hollow  
handle,  
double-ended,

**DE-1613**  
Raspator,  
Micro Raspator /  
chisel  
Length 175 mm,  
8 mm solid handle,  
double-ended  
3.5mm | 3.5 mm,

**IMPLANTOLOGY**

- Инструменты для имплантологии
- Implantologie
- Implantologie
- Інструменти для імплантології
- Implantoloia
- زراعة الأسنان

**PERIOSTEALS ELEVATOR 10mm Hollow Handle**



**DE-1614**  
Raspatory Micro Molt  
Length 175 mm,  
corrosion-resistant

**DE-1615**  
Raspatory Chipping  
Workers:  
Chisel 24G and 7.5 mm,  
length about 175 mm,  
corrosion-resistant

**DE-1616**  
Raspatory MOLT  
Work ends:  
5.0 mm and 4.0 mm,  
length about 175 mm,  
corrosion-resistant

**DE-1617**  
Rasp, Molt M9  
Length 175 mm,  
corrosion-resistant

**DE-1618**  
Raspator, WAUTIER  
Length 175 mm,  
corrosion-resistant

**DE-1619**  
Raspator, BENQUE  
Length 170 mm,  
workers  
5 mm | 7 mm,  
corrosion-resistant

**DE-1620**  
Raspator, Nordberg  
Length 180 mm,  
8 mm hollow handle,  
double-ended  
6 mm | 4 mm

- Инструменты для имплантологии
  - Implantologie
  - Implantologie
- Інструменти для імплантології
  - Implantologia
  - زراعة الأسنان

Hollow Handle 10mm Length 170mm



**IMPLANTOLOGY**

- Инструменты для имплантологии
- Implantologie
- Implantologie
- Инструменти для імплантології
- Implantoloia
- زراعة الأسنان

**TISSUE MEMBRANE FORCEPS**



**DE-1630**  
Tissue Graft Forcep  
Serrated Teeth



**DE-1631**  
Self Locking  
Grooved



**DE-1632**  
Tissue Graft Forcep  
Serrated Teeth



**DE-1633**  
Titanium  
Locking Plier



**DE-1634**  
TC Gripper Carbide  
Tipped Tissue Forceps  
Serrated Carbide Tips  
14.5cm



**DE-1635**  
Adson Carbide  
Tipped Tissue Forceps  
Serrated Carbide Tips  
12cm



**DE-1636**  
Micor Adson 1x2  
Tissue Forcep 12.1cm  
1x2 Teeth - 0.5mm Tips



**DE-1637**  
Adson 7x7  
Tissue Forceps  
7x7 Teeth 12cm



**DE-1638**  
Adson 7x7 Curved  
Tissue Forceps  
7x7 Teeth 12cm



**DE-1639**  
Suture Pliers  
Suture Forceps with  
1.6mm Ring Tip



**DE-1640**  
Debakey Atraumatic  
Tissue Forceps Straight  
Serrated Teeth  
16cm



**DE-1641**  
Debakey Atraumatic  
Tissue Forceps Curved  
Serrated Teeth  
16cm



- Инструменты для имплантологии
  - Implantologie
  - Implantologie
- Інструменти для імплантології
  - Implantologia
  - زراعة الأسنان

TISSUE MEMBRANE FORCEPS

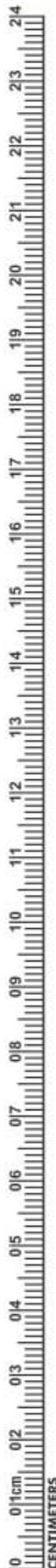

**DE-1642**  
Russian Long  
Tissue Forceps  
Serrated Tip  
20cm



**DE-1643**  
Russian  
Tissue Forceps  
Serrated Tip  
15cm



**DE-1644**  
Tissue Punch Forceps  
To Remove Tissue  
After Using Punch



**DE-1645**  
13.5 cm  
narrow  
**Membrane tweezers KUEHNE**



**DE-1646**  
10.5 cm  
**Membrane tweezers KUEHNE**



**DE-1647**  
13.5 cm  
wide



**DE-1648**  
**Pin-Tweezers**  
with or without lock,  
length 15 cm,  
with lock



**DE-1649**  
without lock,



**DE-1650**  
**Haltepinzette with lock**  
15,5 cm, for pins, towards  
the tips, etc.,



**DE-1651**  
Carry Forceps  
15cm



**DE-1652**  
Carry Forceps  
15cm



**DE-1653**  
Carry Forceps  
15cm

**IMPLANTOLOGY**

- Инструменты для имплантологии
- Implantologie
- Implantologie
- Инструменти для імплантології
- Implantologia
- زراعة الأسنان

**OSTEOTOME CONVEXES / CONCAVE / CONIQUES**

CONVEXES



**DE-1654**  
SET OF 5 PIECES

CONCAVES



**DE-1655**  
SET OF 5 PIECES

CONIQUES



**DE-1656**  
SET OF 5 PIECES

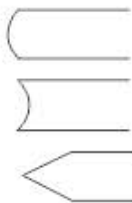
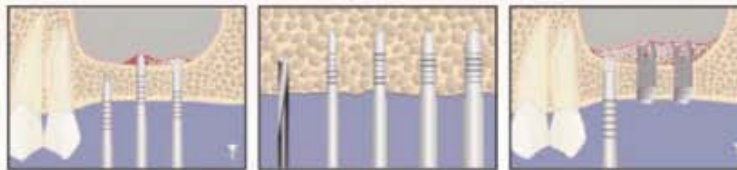

CONVEXES STRAIGHT	DE-1654	2,7 Ømm	3,2 Ømm	3,7 Ømm	4,2 Ømm	5 Ømm
CONCAVES STRAIGHT	DE-1655	2,7 Ømm	3,2 Ømm	3,7 Ømm	4,2 Ømm	5 Ømm
CONIQUES STRAIGHT	DE-1656	2,7 Ømm	3,2 Ømm	3,7 Ømm	4,2 Ømm	5 Ømm





- Инструменты для имплантологии
  - Implantologie
  - Implantologie
- Інструменти для імплантології
  - Implantologia
  - زراعة الأسنان

OSTEOTOME CONVEXES / CONCAVE / CONIQUES



**DE-1657**  
SET OF 5 PIECES

**DE-1658**  
SET OF 5 PIECES

**DE-1659**  
SET OF 5 PIECES

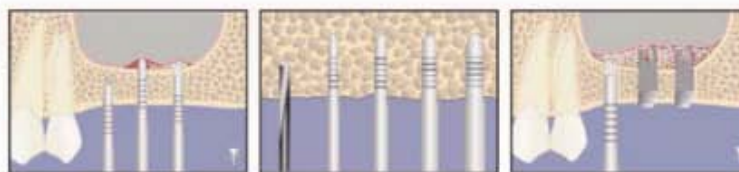

	CONVEXES CURVED	DE-1657	2,7 Ømm	3,2 Ømm	3,7 Ømm	4,2 Ømm	5 Ømm
	CONCAVES CURVED	DE-1658	2,7 Ømm	3,2 Ømm	3,7 Ømm	4,2 Ømm	5 Ømm
	CONIQUES CURVED	DE-1659	2,7 Ømm	3,2 Ømm	3,7 Ømm	4,2 Ømm	5 Ømm

**IMPLANTOLOGY**

- Инструменты для имплантологии
  - Implantologie
  - Implantologie
- Інструменти для імплантології
  - Implantologia
  - زراعة الأسنان

**TREPHINE**

Burs with depth markings are suited for precise and simple transplantation of cylindrical bone grafts as well as for all other bone-extraction tasks.



**DE-1669**  
Tissue Punch with pin  
Set of Four Pieces



**DE-1670**  
Tissue Punch  
Set of Five Pieces



**DE-1671**  
Tissue Punch  
Set of Five Pieces



**DE-1672**  
Trephine Drill  
Set of Eight Pieces



Ø2.0mm   Ø2.5mm   Ø2.8mm  
**DE-1673**  
Short Implant Drills

Ø3.2mm   Ø3.65mm   Ø4.2mm   Ø5.2mm  
**DE-1674**  
Long Implant Drills



**DE-1675**  
Trephine Drill  
Set of Eight Pieces



- Инструменты для имплантологии
  - Implantologie
  - Implantologie
- Інструменти для імплантології
  - Implantologia
  - زراعة الأسنان

BONE SCRAPER STRAIGHT & CURVED



DE-1676  
Bone Scraper  
Straight

DE-1677  
Bone Scraper  
Curved

TISSUE PUNCH STRAIGHT & CURVED



- DE-1679  
2.0mm
- DE-1681  
5.0mm
- DE-1683  
7.0mm

DE-1678  
Tissue Punch  
Straight



DE-1685  
Tissue Punch  
Curved

- DE-1680  
4.0mm
  - DE-1682  
6.0mm
  - DE-1684  
8.0mm
- DE-1686  
2.0mm
  - DE-1688  
5.0mm
  - DE-1690  
7.0mm
  - DE-1687  
4.0mm
  - DE-1689  
6.0mm
  - DE-1691  
8.0mm



DE-1692  
Bone Mill



DE-1693  
Basins For Bone



BONE CRUSHER  
DE-1694



**IMPLANTOLOGY**

- Инструменты для имплантологии
- Implantologie
- Implantologie
- Інструменти для імплантології
- Implantologia
- زراعة الأسنان

**KEYS FOR IMPLANT SCREW**



DE-1695

DE-1696

DE-1697

DE-1698

**TORQUE WRENCH & RATCHET**



DE-1699 Star Torque Wrench 6.35mm Universal



DE-1700 Round Torque Wrench 4.0mm Universal



DE-1701 Hex Driver With 4.0mm Driver



DE-1702 Star Torque Wrench 6.35mm Universal



DE-1703 Hex Torque Wrench 4.00mm Universal



DE-1704 Star Torque Wrench 6.35mm Universal



DE-1705 Star Torque Wrench 6.35mm Universal



DE-1706 Star Torque Wrench 6.35mm Universal



DE-1707 Star Torque Wrench 6.35mm Universal



DE-1708 Star Torque Wrench 6.35mm Universal



DE-1709 Star Ratchet Wrench 6.35mm Universal



DE-1710 Star Ratchet Wrench 6.35mm Universal



DE-1711 Star Ratchet Wrench 6.35mm Universal



DE-1712 Star Ratchet Wrench 4.0mm Universal



DE-1713 Round Ratchet Wrench 4.0mm Universal



DE-1714 Round Ratchet Wrench 3.35mm Universal



DE-1715 Star Ratchet Wrench 4.0mm Universal



DE-1716 Star Ratchet Wrench 6.35mm Universal



- Инструменты для имплантологии
- Implantologie
- Implantologie
- Інструменти для імплантології
- Implantologia
- زراعة الأسنان

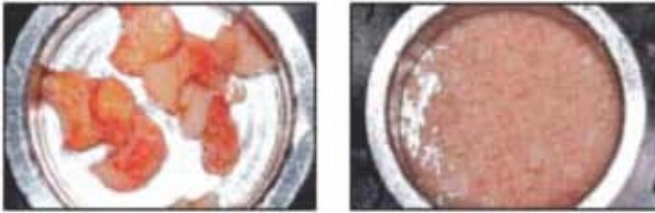

DE-1717  
BONE CRUSHER  
Titanium Metal Cutter

mallet



DE-1718  
BONE CRUSHER  
Titanium Metal Cutter

mallet



DE-1719  
BONE CRUSHER



DE-1720  
BONE CRUSHER  
Bone Grinding Grain  
1.5mm, 2mm, 2.5mm



DE-1721  
BONE CRUSHER  
Bone Grinding Grain  
1.5mm, 2mm, 2.5mm



**IMPLANTOLOGY**

- Инструменты для имплантологии
- Implantologie
- Implantologie
- Инструменти для імплантології
- Implantologia
- زراعة الأسنان

**BONE EXPANDER SCREW & SURGICAL KITS**



**DE-1722**  
 Bone Universal Kit  
 Drill: 2mm, 2.8mm, 3.2mm, 3.65mm,  
 4.2mm, 4.5mm, 4.8mm, 5.2mm  
 Trephines Bit:  
 3.0mm, 4.0mm, 5.0mm, 6.0mm,  
 7.0mm, 8.0mm, 9.0mm, 10mm.  
 Driver:  
 2.5mm, 2.5mm Hand Pcs  
 1.25mm, 1.25mm Hand Pcs  
 Short Driver 2.5mm  
 Long Driver 2.5mm  
 1.25mm, Short Hex Driver Hand Pcs  
 1.25mm, Long Hex Driver Hand Pcs  
 Torque Wrench 4.0mm



**DE-1723**  
 Bone Expander Kit  
 Expander: 2.6mm, 3.0mm,  
 3.4mm, 3.8mm, 4.3mm  
 Ratchet Driver  
 Parallel Pin  
 Pilot Drill  
 Drill 1.4mm  
 Drill Driver 4mm  
 Hand Driver 4mm  
 Ratchet 4.0mm



**DE-1724**  
 Bone Universal Kit  
 Drill: 2mm, 2.8mm, 3.2mm, 3.65mm,  
 4.2mm, 4.5mm, 4.8mm, 5.2mm  
 Trephines Bit:  
 3.0mm, 4.0mm, 5.0mm, 6.0mm,  
 7.0mm, 8.0mm, 9.0mm, 10mm.

Bone Compression:  
 2mm, 3.3mm, 2.8mm, 4.2mm, 3mm, 3.5mm  
 Driver:  
 2.5mm, 2.5mm Hand Pcs  
 1.25mm, 1.25mm Hand Pcs  
 Short Driver 2.5mm  
 Long Driver 2.5mm  
 1.25mm, Short Hex Driver Hand Pcs  
 1.25mm, Long Hex Driver Hand Pcs  
 Torque Wrench 6.35mm 1 Pcs



**DE-1725**  
 Conical Drills: 20 Pcs  
 Tissue Punches:  
 3.0mm, 3.50mm, 4.0mm, 4.5mm,  
 5.0mm, 6.0mm, 6.50mm  
 Bone Expander:  
 1.6/3.8mm, 1.9/3.0mm, 2.1/3.6mm,  
 2.6/3.8mm, 2.9/4.3mm  
 Drill Adapter: 1 Pcs  
 1.25mm, 2.50mm Hex Driver Hand Pcs

Pilot Drill: 1.6mm  
 Drill Bit: 1.4mm, 1.6mm, 1.8mm, 2.0mm, 2.2mm  
 Ratchet Driver: 4mm/6.35, 1.25/2.50  
 Rimer: 3.2/4.7mm, 3.7/4.7mm  
 Parallel Pin: 4.5mm, 2.5mm  
 Double step Drill: 2.4/2.8mm  
 Depth Gauge: 1 Pcs  
 Torque Wrench 6.35mm Universal: 1 Pcs



- Инструменты для имплантологии
  - Implantologie
  - Implantologie
- Инструменти для имплантології
  - Implantologia
  - زراعة الأسنان

BONE INJECTORS, COLLECTORS & SUCTION TUBE



**DE-1726**  
Ø 2,5mm / 3,5mm  
170mm

**DE-1727**  
Ø 4,5mm / 5,5mm  
170mm

**DE-1728**  
Ø 3,5mm / 4,5mm  
170mm

**DE-1729**  
Ø 6,0mm / 7,0mm  
170mm



**DE-1730**  
18cm  
Straight / Bend  
I.D 2.5mm  
O.D 3.5

**DE-1731**  
18cm  
Straight / Bend  
I.D 3.5mm  
O.D 4.5

**DE-1732**  
18cm  
Straight / Bend  
I.D 4.5mm  
O.D 5.5

**DE-1733**  
18cm  
Straight / Bend  
I.D 6.0mm  
O.D 7.0



**DE-1734**  
17.5cm

**DE-1735**  
18cm

**DE-1736**  
coarse  
Ø 5mm

**DE-1737**  
fine  
Ø 9mm

Suction tubes to collect the extracted bone material 180mm



**DE-1738**  
Suction Tubes  
180mm

**DE-1739**  
Suction Tubes  
180mm

**DE-1740**  
Suction Tubes  
180mm



**DE-1741**  
Fig. 6FR  
Frazier  
15 cm - Ø 2 mm

**DE-1742**  
Ø 3 mm  
length 180mm

**DE-1743**  
Ø 4 mm  
length 180mm

**DE-1744**  
Ø 5 mm  
length 180mm

**IMPRESSION TRAYS**

- Оттисковые ложки
- Відбиткові ложки
- Porte-empreinte
- Cubetas para impresiones
- Abdrucklöffel
- صوتی الاتطباع

**PERFORATED WITH RIM LOCK**  
Set of 06 Pcs

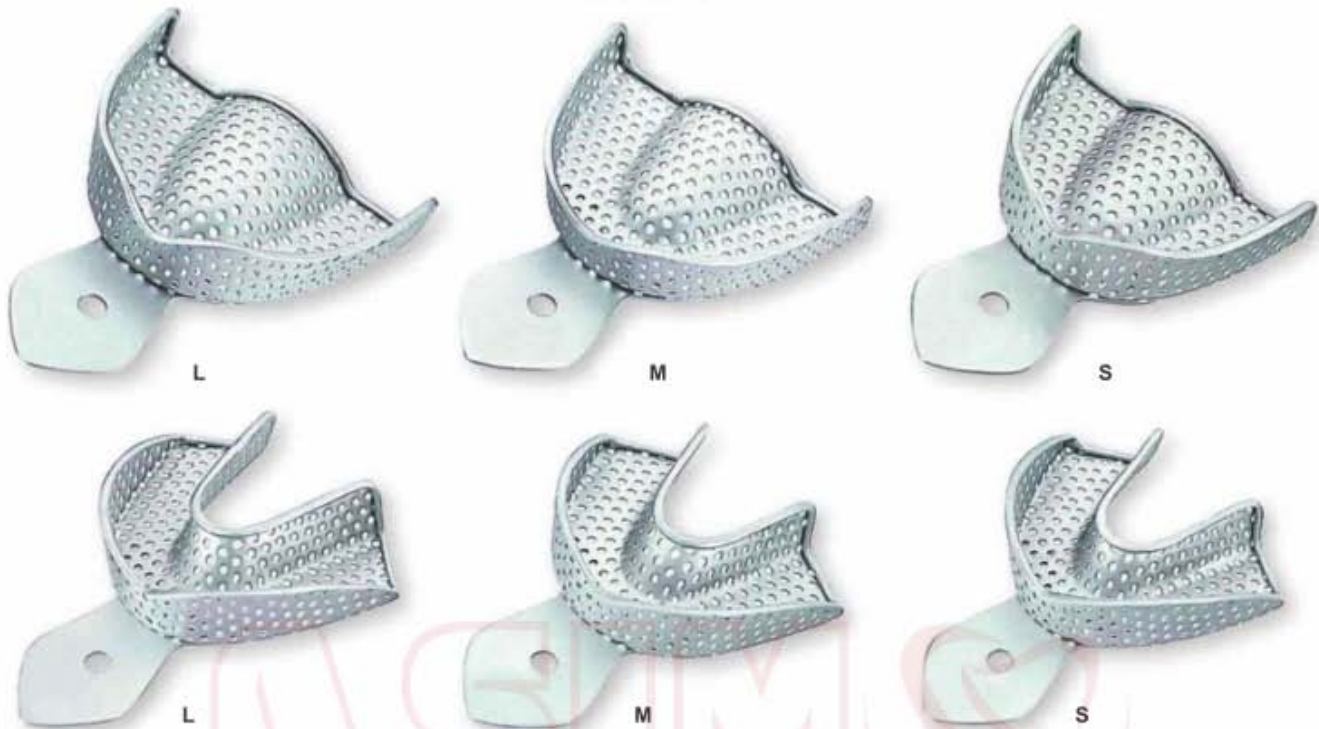

**DE-1745 SET OF 06 PCS**  
Upper: S, M, L  
Lower: S, M, L

**PERFORATED WITH RIM LOCK**  
Set of 8 Pcs



**DE-1746 SET OF 08 PCS**  
Upper: XS, S, M, L  
Lower: XS, S, M, L

**DE-1747 SET OF 08 PCS**  
Upper: S, M, L, XL  
Lower: S, M, L, XL

**DE-1748 SET OF 10 PCS**  
Upper: XS, S, M, L, XL  
Lower: XS, S, M, L, XL







- Оттисные ложки
  - Porte-empreinte
  - Abdrucklöffel
- Відбиткові ложки
  - Cubetas para impresiones
  - صواني الانطباع

**SOLID WITH RIM LOCK**  
Set of 6 Pcs



**DE-1749 SET OF 06 PCS**  
Upper: S, M, L  
Lower: S, M, L

**SOLID WITH RIM LOCK**  
Set of 8 Pcs



**DE-1750 SET OF 08 PCS**  
Upper: XS, S, M, L  
Lower: XS, S, M, L

**DE-1751 SET OF 08 PCS**  
Upper: S, M, L, XL  
Lower: S, M, L, XL

**DE-1752 SET OF 10 PCS**  
Upper: XS, S, M, L, XL  
Lower: XS, S, M, L, XL

**IMPRESSION TRAYS**

- Оттисковые ложки
- Відбиткові ложки
- Porte-empreinte
- Cubetas para impresiones
- Abdrucklöffel
- صوتی الاطباع

**PERFORATED FULL DENTURE**  
Set of 8 Pcs

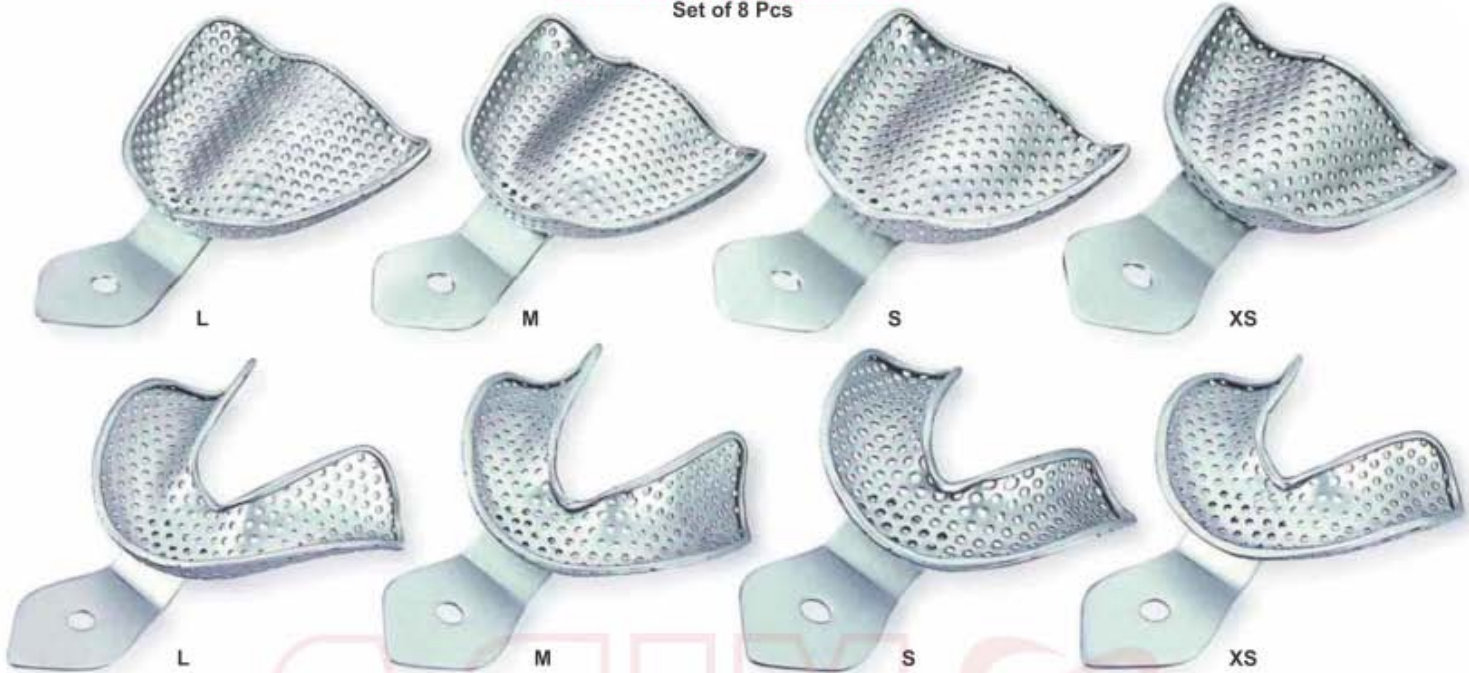

**DE-1753 SET OF 08 PCS**  
Upper: S, M, L, XL  
Lower: S, M, L, XL

**DE-1754 SET OF 08 PCS**  
Upper: S, M, L  
Lower: S, M, L

**SOLID FULL DENTURE**  
Set of 8 Pcs



**DE-1755 SET OF 08 PCS**  
Upper: S, M, L, XL  
Lower: S, M, L, XL

**DE-1756 SET OF 06 PCS**  
Upper: S, M, L  
Lower: S, M, L



- Оттисные ложки
  - Porte-empreinte
  - Abdrucklöffel
- Відбиткові ложки
  - Cubetas para impresiones
  - صواني الانطباع

Perforated Without Rim Lock



Solid With Rim Lock

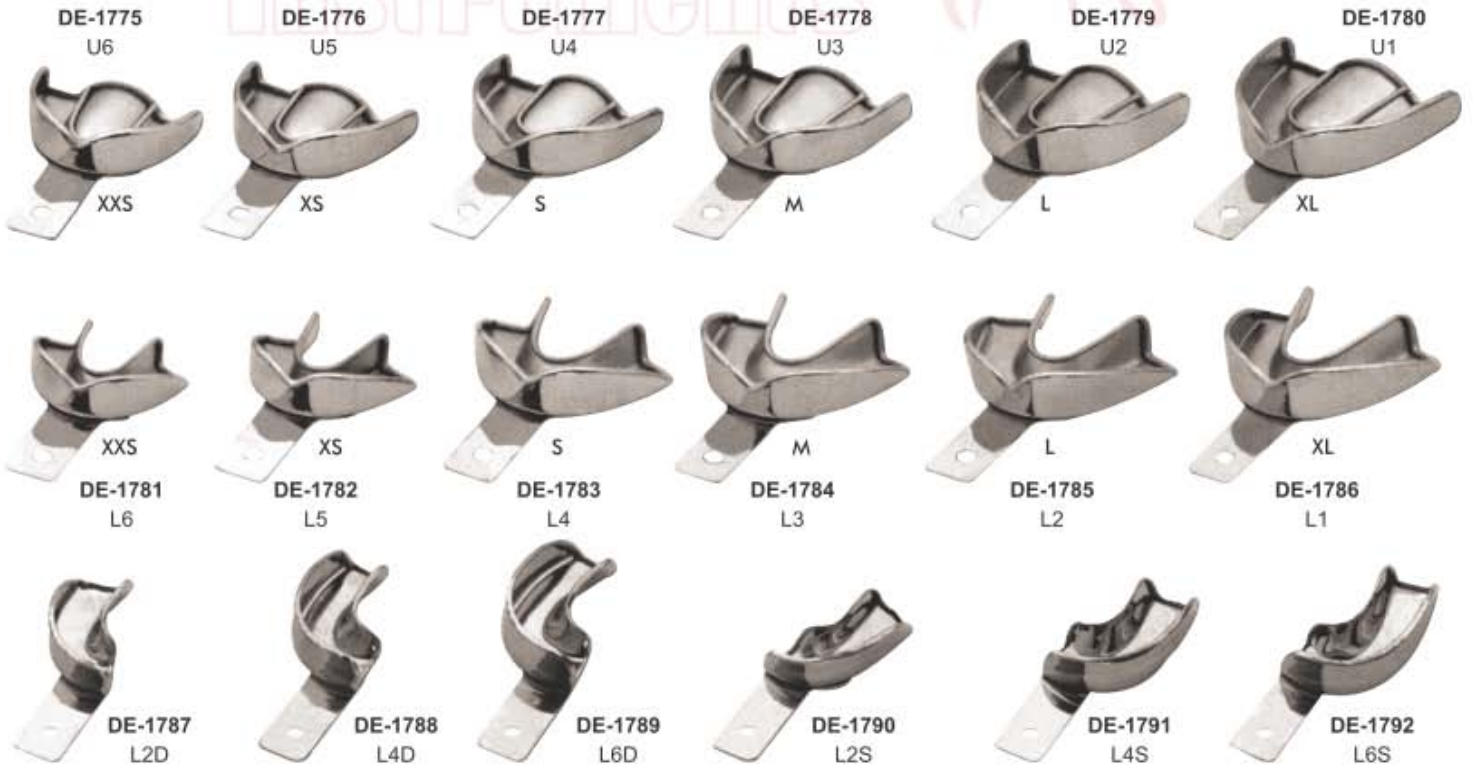



**DE-1793**  
Instruments Cassettes  
5 Pieces, 7 Pieces, 10 Pieces & 20 Pieces



**DE-1794**  
Instruments Cassettes  
5 Pieces, 7 Pieces, 10 Pieces & 20 Pieces

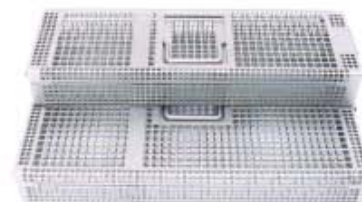

**DE-1795**  
Instruments Cassette  
7 Pieces & 10 Pieces



**DE-1796**  
Gracey Curette Set Cassettes



**DE-1797**  
182 x 150 x 20 mm  
10 Instruments

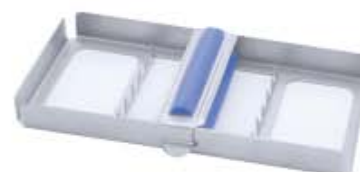

**DE-1798**  
180 x 85 x 15 mm  
5 Instruments



**DE-1799**  
288 x 182 x 35 mm  
20 Instruments



**DE-1800**  
288 x 182 x 35 mm  
20 Instruments



**DE-1801**  
182 x 145 x 35 mm  
10 Instruments



**DE-1802**  
182 x 72 x 35 mm  
5 Instruments



**DE-1803**  
182 x 145 x 35 mm  
9 Instruments

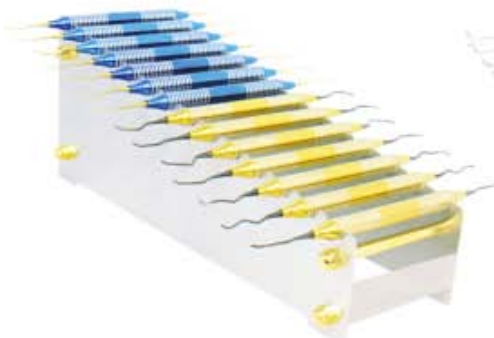

**DE-1804**  
Gracey Curette Set Stand



**DE-1805**  
Sinus Lift Set Stand



Made of 18/8 stainless steel



**KIDNEY TRAY WITH COVER**  
(English Pattern)

	Size
DE-1806	150 mm
DE-1807	200 mm
DE-1808	240 mm
DE-1809	300 mm



**Kidney Trays**

With lid available	Without lid available
DE-1810 6"	DE-1814 6"
DE-1811 8"	DE-1815 8"
DE-1812 10"	DE-1816 10"
DE-1813 12"	DE-1817 12"



Deep	
DE-1818	2.25" - 2"
DE-1819	4.75" - 2"
DE-1820	5.5" - 2.5"
DE-1821	6.25" - 2.75"
DE-1822	7" - 3.5"



**Sterilizing Drum**

Art #	mm	h mm
DE-1823	80	80
DE-1824	120	120
DE-1825	160	120
DE-1826	190	140
DE-1827	190	200
DE-1828	240	120
DE-1829	240	160
DE-1830	240	240
DE-1831	290	120
DE-1832	290	160
DE-1833	290	240
DE-1834	340	160
DE-1835	340	240
DE-1836	390	145
DE-1837	390	200
DE-1838	390	290



**Cotton Holder - DE-1839**



**Spirit Lamp DE-1840**



**DE-1841 Endodontic Box**



Forcep Jar	
DE-1842	25 x 80mm
DE-1843	30 x 100mm
DE-1844	100 x 200mm
DE-1845	75 x 173mm



DE-1846	6" x 8"
DE-1847	8" x 10"
DE-1848	10" x 12"

Without Lid



**DE-1849 Instruments Box**



**SCALER TRAY DE-1850**  
100 x 200 mm

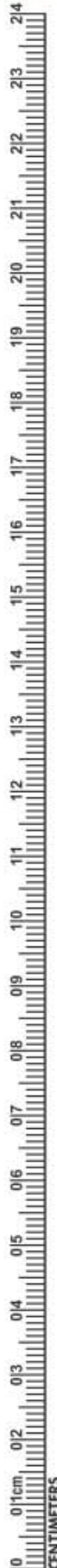

ROOT FRAGMENT FORCEPS



**Witzel  
DE-1851**  
170mm  
Upper roots, Universal



**Witzel  
DE-1852**  
165mm  
Lower roots, Universal



**DE-1853**  
#400(300)  
165mm  
Upper roots, Universal



**DE-1854**  
#401(301)  
160mm  
Lower roots, Universal



**DE-1855**  
Witzel Forceps With Gold  
Set of 3 Pcs



**DE-1859**  
Witzel Forceps With Hole And Screw Pattern  
Set of 3 Pcs



**DE-1863**  
Witzel Forceps With Anatomical Handle  
Set of 3 Pcs



**DE-1856**  
#401(301)  
160mm  
Lower roots, Universal



**DE-1860**  
#401(301)  
160mm  
Lower roots, Universal



**DE-1864**  
#401(301)  
160mm  
Lower roots, Universal



**DE-1857**  
#400(300)  
165mm  
Upper roots, Universal



**DE-1861**  
#400(300)  
165mm  
Upper roots, Universal



**DE-1865**  
#400(300)  
165mm  
Upper roots, Universal



**Witzel  
DE-1858**  
165mm  
Lower roots, Universal



**Witzel  
DE-1862**  
165mm  
Lower roots, Universal



**Witzel  
DE-1866**  
165mm  
Lower roots, Universal



ROOTS SPLINTER FORCEPS

- Щипцы для удаления корневых осколков
- Pincers Fragments
- Wurzelsplitterzangen

- Щипці для видалення корневих осколків
- Pinzas Para Fragmentos
- جذور منشقة الملقظ



DE-1867  
Splinter Forceps  
15.5cm



Stieglitz Root Splinter Forceps



DE-1868  
Splinter Forceps  
15.5cm 45°



DE-1869  
Stieglitz  
Root Fragments



DE-1870  
Stieglitz  
Root Fragments



DE-1871  
Stieglitz Splinter Forceps  
140mm 90°



DE-1872  
Stieglitz Splinter Forceps  
140mm Straight



ROOT FRAGMENT FORCEPS

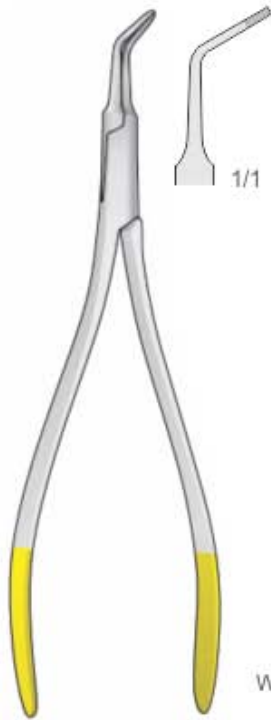

With Diamond

DE-1873  
130mm



With Diamond

DE-1874  
130mm

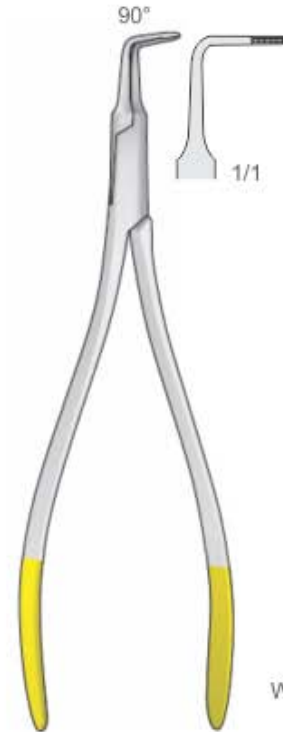

With Diamond

DE-1875  
125mm



DE-1876  
130mm



DE-1877  
130mm

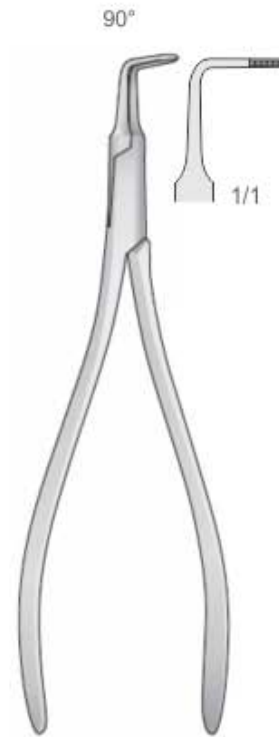

DE-1878  
125mm





EXTRACTING FORCEPS (English Pattern)

- Щипцы экстракционные (английская форма)
- Daviers (Forme Anglaise)
- Zahnzangen (Englische Form)
- Щипці екстракційні (англійська форма)
- Forceps de Extracció (Forme Inglesa)
- استخراج المنقط (نمط اللغة الإنجليزية)

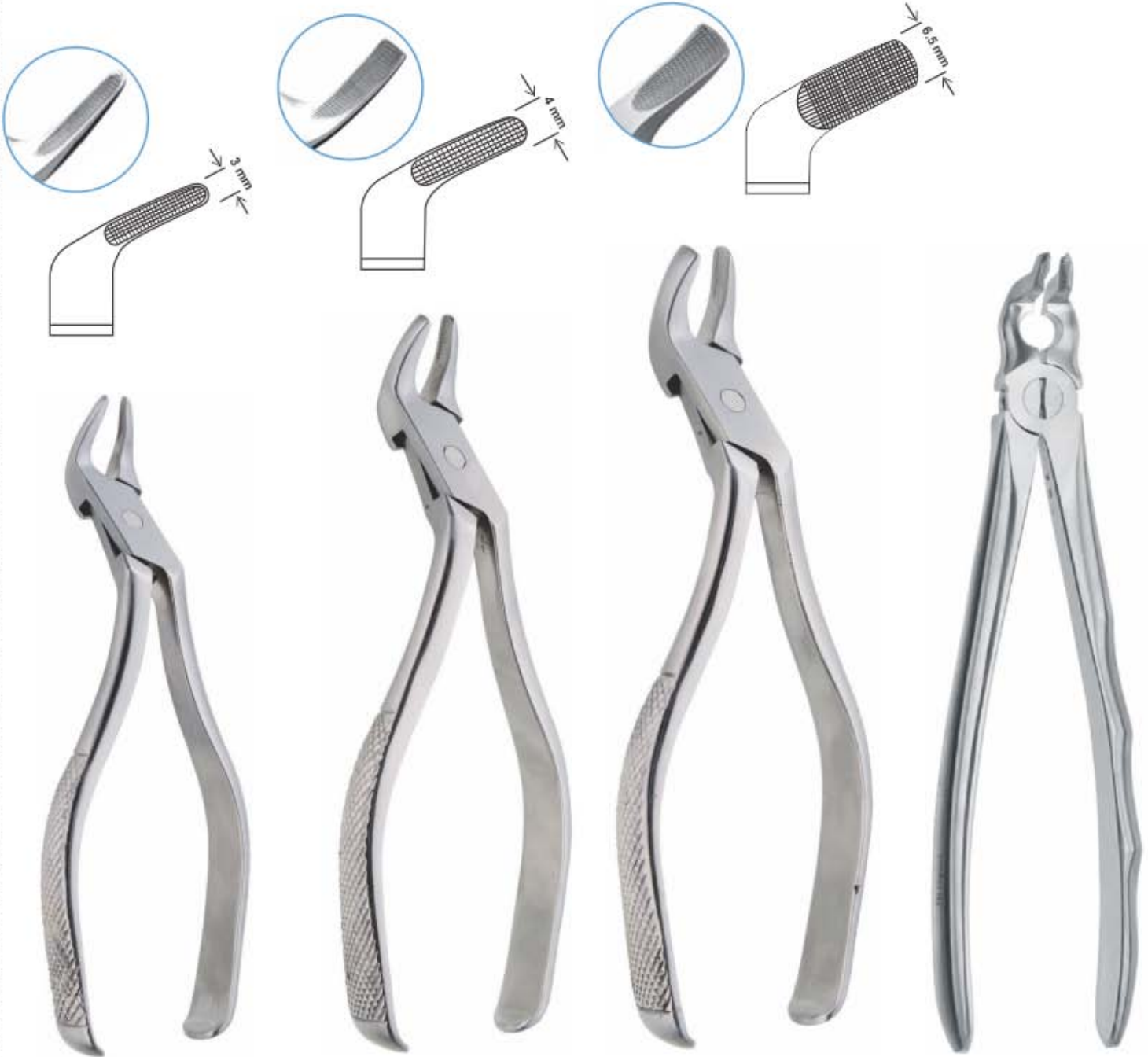
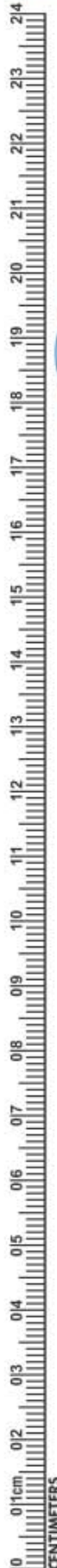

**DE-1879**  
Meissner  
Extracting Forceps

**DE-1880**  
Meissner  
Extracting Forceps

**DE-1881**  
Meissner  
Extracting Forceps

**DE-1882**  
Comellas Forceps  
Anatomical Handle

**EXTRACTING FORCEPS SET**

- Извлечение щипцов
- Ensemble de pinces d'extraction
- Zange sammeln
- Витягуючий комплект щипців
- Extracción del conjunto de fórceps
- استخراج ملقط مجموعة



**DE-1883**  
Extracting Forceps  
Set of 10 Pieces  
Extracting Forceps Fig. 2  
Extracting Forceps Fig. 7  
Extracting Forceps Fig. 13  
Extracting Forceps Fig. 17  
Extracting Forceps Fig. 18  
Extracting Forceps Fig. 22  
Extracting Forceps Fig. 33  
Extracting Forceps Fig. 51A  
Extracting Forceps Fig. 67A  
Extracting Forceps Fig. 79



**DE-1884**  
Extracting Forceps  
Set of 10 Pieces  
Extracting Forceps Fig. 2  
Extracting Forceps Fig. 7  
Extracting Forceps Fig. 13  
Extracting Forceps Fig. 17  
Extracting Forceps Fig. 18  
Extracting Forceps Fig. 22  
Extracting Forceps Fig. 33  
Extracting Forceps Fig. 51A  
Extracting Forceps Fig. 67A  
Extracting Forceps Fig. 79



**DE-1885**  
Extracting Forceps  
Set of 13 Pieces  
Extracting Forceps Fig. 2  
Extracting Forceps Fig. 7  
Extracting Forceps Fig. 13  
Extracting Forceps Fig. 17  
Extracting Forceps Fig. 18  
Extracting Forceps Fig. 22  
Extracting Forceps Fig. 33  
Extracting Forceps Fig. 51A  
Extracting Forceps Fig. 67A  
Extracting Forceps Fig. 79  
Extracting Forceps Fig. 86C  
Extracting Forceps Fig. 89  
Extracting Forceps Fig. 90



**DE-1886**  
Extracting Forceps Children Pattern  
Set of 10 Pieces  
Extracting Forceps Fig. 13S  
Extracting Forceps Fig. 22S  
Extracting Forceps Fig. 30S  
Extracting Forceps Fig. 33S  
Extracting Forceps Fig. 37  
Extracting Forceps Fig. 38  
Extracting Forceps Fig. 39  
Extracting Forceps Fig. 39L  
Extracting Forceps Fig. 39R  
Extracting Forceps Fig. 51S



**DE-1887**  
Extracting Forceps English adult Adult  
Set of 10 Pcs



**DE-1888**  
Extracting Forceps American Adult  
Set of 10 Pcs



**DE-1889**  
Extracting Forceps American Adult  
Set of 8 Pcs



**DE-1890**  
Extracting Forceps Pedro  
Set of 7 Pcs



ROOT ELEVATOR

- Элеватор корневой экстракционный
- Elévateurs à racines
- Wurzelheber
- Elevator corneviu extracționiu
- Elevadores para raices
- المصاعد الجذر



DE-1891  
Fig. 1  
Chompret



DE-1892  
Fig. 2  
Chompret



DE-1893  
Fig. 3  
Chompret



DE-1894  
Fig. 4  
Chompret



Lecluse elevator for lower third molar dislocation



Chompret syndesmotome, sickle pattern



DE-1895



DE-1896



DE-1897



DE-1898



DE-1899



DE-1900



DE-1901

Root Pick Elevator With Gold Flexible Points

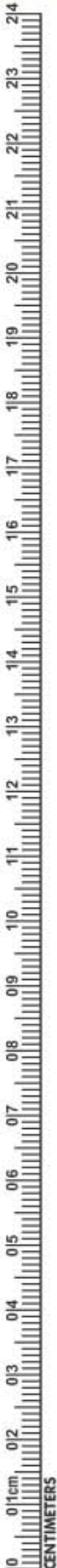

# ROOT ELEVATOR

- Элеватор корневой экстракционный
- Elévateurs à racines
- Wurzelheber
- Слеватор корневий экстракційний
- Elevadores para raices
- المصاعد الجذر

**FUNCTION:** To loosen small root fragments from bony socket

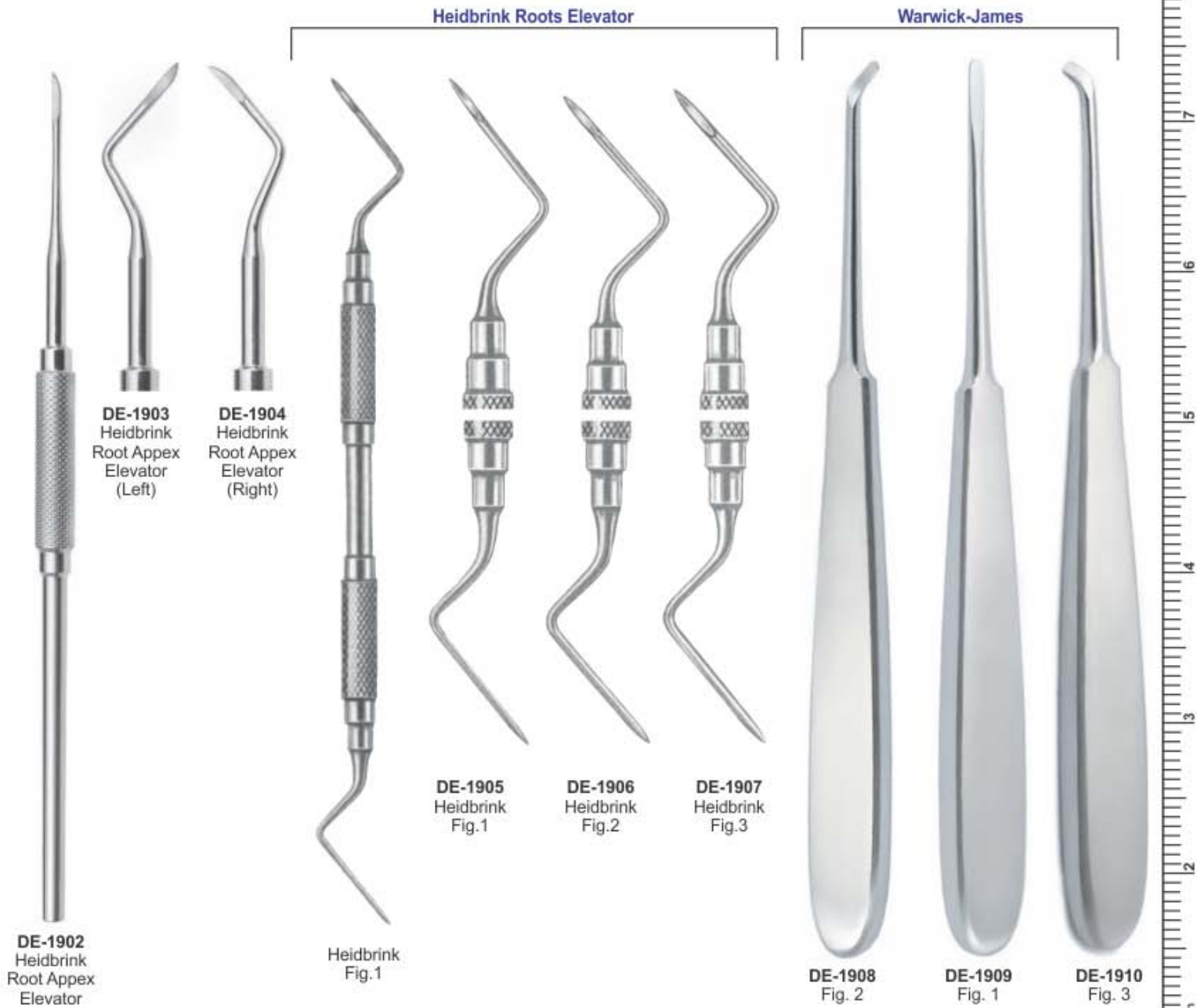

ROOT ELEVATOR

- Элеватор корневой экстракционный
- Elévateurs à racines
- Wurzelheber
- Елеватор кореневий екстракційний
- Elevadores para raices
- المصاعد الجذر



**DE-1911**  
Luxators Set of 7 Pcs

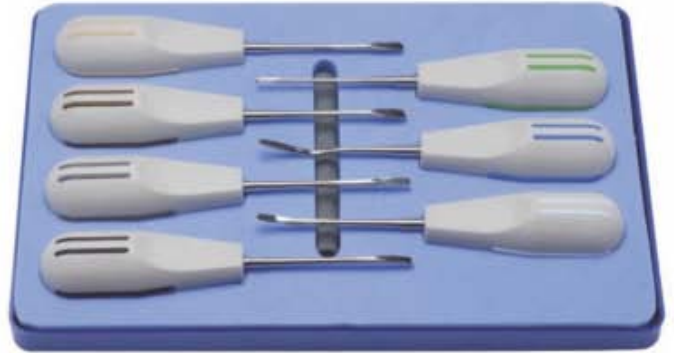

**DE-1912**  
Luxators Set of 7 Pcs



**DE-1913**  
Luxators Set of 8 Pcs



**DE-1914**  
Root Elevators Set of 10 Pcs



**DE-1915**  
Elevators Set of 8 Pcs



**DE-1916**  
Elevators Set of 8 Pcs

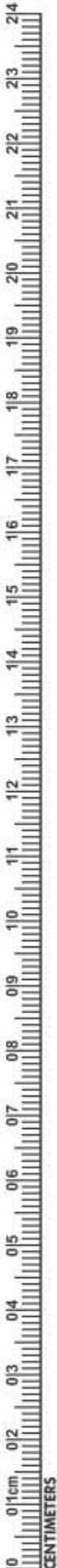

# EXPLORERS

- Зонды
  - Sondes
  - Zahnsonden
- Зонди
  - Sondas
  - المستكشفين

Examination kit Set of 3 Pieces



**DE-1917** Probe  
**DE-1918** Mirror  
**DE-1919** College Forcep  
 15cm



Examination Set of 4 Pieces



**DE-1920** Exp.23/17-A  
**DE-1921** Excavators  
**DE-1922** Tweezers  
**DE-1923** Mouth Mirror

**DE-1924**

First Aid Examination Set of 3 Pieces



**DE-1925**

First Aid Examination Set of 3 Pieces



**DE-1926**

First Aid Examination Set of 3 Pieces



**DE-1927**

First Aid Examination Set of 3 Pieces



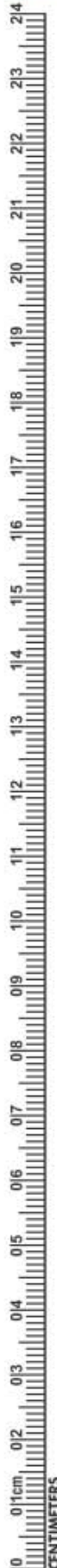

**DE-1928**  
Gracey Curettes 1/2



**DE-1929**  
Gracey Curettes 3/4



**DE-1930**  
Gracey Curettes 5/6



**DE-1931**  
Gracey Curettes 7/8



**DE-1932**  
Gracey Curettes 9/10



**DE-1933**  
Gracey Curettes 11/12



**DE-1934**  
Gracey Curettes 13/14



**DE-1935**  
Gracey Curettes 1/2



**DE-1936**  
Gracey Curettes 3/4



**DE-1937**  
Gracey Curettes 5/6



**DE-1938**  
Gracey Curettes 7/8



**DE-1939**  
Gracey Curettes 9/10



**DE-1940**  
Gracey Curettes 11/12



**DE-1941**  
Gracey Curettes 13/14



**SCALER**

**GRACEY MINI FIVE**

Hollow Handle 9.5mm, Length 170mm Ceramic Coated Handle

**GRACEY AFTER FIVE**

Hollow Handle 9.5mm, Length 170mm Ceramic Coated Handle



**DE-1943**  
Fig. 3/4 Gracey 3M



**DE-1949**  
Gracey 3/4 AF



**DE-1944**  
Fig. 5/6 Gracey 3M



**DE-1950**  
Gracey 5/6 AF



**DE-1945**  
Fig. 7/8 Gracey 3M  
Buccal and lingual/  
Palatal surfaces



**DE-1951**  
Gracey 7/8 AF



**DE-1946**  
Fig. 11/12 Gracey 3M  
Mesial



**DE-1952**  
Gracey 11/12 AF



**DE-1947**  
Fig. 13/14 Gracey 3M  
Distal



**DE-1953**  
Gracey 13/14 AF



**DE-1942**  
Fig. 1/2  
Gracey 3m

**DE-1948**  
Gracey  
1/2 AF





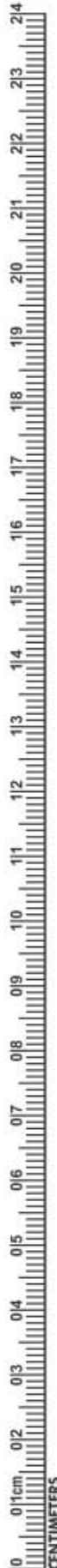

Gracey Curettes



$\frac{3...1}{3...1} \mid \frac{1...3}{1...3}$  **DE-1954** Fig. 1/2 GR - Gracey  
Buccal surfaces



$\frac{5...1}{5...1} \mid \frac{1...5}{1...5}$  **DE-1955** Fig. 3/4 GR - Gracey  
Lingual/Palatal surfaces



$\frac{5...1}{5...1} \mid \frac{1...5}{1...5}$  **DE-1956** Fig. 5/6 GR - Gracey



$\frac{8...4}{8...4} \mid \frac{4...8}{4...8}$  **DE-1957** Fig. 7/8 GR - Gracey  
Buccal and lingual/  
palatal surfaces



$\frac{8...4}{8...4} \mid \frac{4...8}{4...8}$  **DE-1958** Fig. 9/10 GR - Gracey  
Buccal and lingual/  
palatal surfaces more angled



$\frac{8...4}{8...4} \mid \frac{4...8}{4...8}$  **DE-1959** Fig. 11/12 GR - Gracey  
Mesial



$\frac{8...4}{8...4} \mid \frac{4...8}{4...8}$  **DE-1960** Fig. 13/14 GR - Gracey  
Distal



$\frac{8...4}{8...4} \mid \frac{4...8}{4...8}$  **DE-1961** Fig. 15/16 GR - Gracey  
Mesial



$\frac{8...4}{8...4} \mid \frac{4...8}{4...8}$  **DE-1962** Fig. 17/18 GR - Gracey  
Distal



- #10 - #34 - #36
- #38 - #90
- #110 - #130
- #134 - #170



- #10 - #34 - #36
- #38 - #90
- #110 - #130
- #134 - #170

**SCALER**

**Sickle Scalers**



DE-1963 Fig. U15/33 - Towner-Jaquette



DE-1964 Fig. U15/30 - Towner-Jaquette



DE-1965 Fig. H5/33



DE-1966 Fig. H6/H7



DE-1967 Fig. 30/33 - Jaquette



DE-1968 Fig. T2/T3 - Taylor



DE-1969 Fig. 204



DE-1970 Fig. 204S



DE-1971 Fig. 11/12 - MC - McCall  
Mesial



DE-1972 Fig. 13/14 - MC - McCall  
Distal

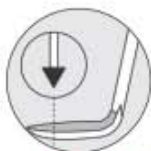

**Straight and curved sickle scalers**

Feature: 2 cutting edges curved facial component tipped ends



**Universal curettes**

are characterized by an angle of 90° between the terminal stem and the cutting component.

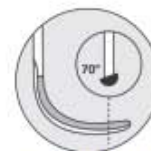
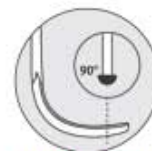

**Gracey curettes**

are characterized by an angle of 70° between the terminal stem and the cutting component.



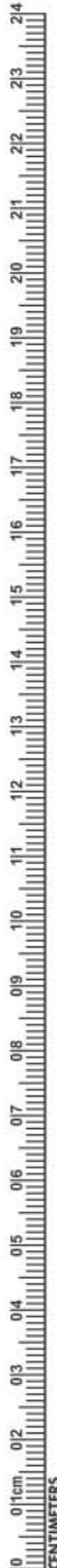

**Universal Curettes**



DE-1973 Fig. 13S/14S - MC - McCall



DE-1974 Fig. 17S/18S - MC - McCall Distal



DE-1975 Fig. M23



DE-1976 Fig. 204SD



DE-1977 Fig. YG7/8-Younger Good



DE-1978 Fig. L 1/2 - Langer



DE-1979 Fig. L 3/4 - Langer



DE-1980 Fig. L 5/6 - Langer



DE-1981 Fig. M 23A



DE-1982 Fig. M 23B

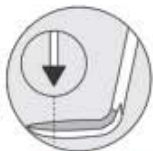

**Straight and curved sickle scalers**  
Feature: 2 cutting edges curved facial component tipped ends



**Universal curettes**  
are characterized by an angle of 90° between the terminal stem and the cutting component.

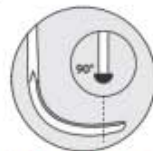

**Gracey curettes**  
are characterized by an angle of 70° between the terminal stem and the cutting component.

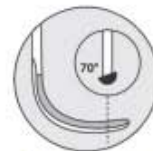

BURNISHERS CONSERVATIVE TREATMENT



DE-1983  
WHITE 28



DE-1984  
WHITE 29



DE-1985  
WHITE 31



DE-1986  
WHITE 32



DE-1987  
WHITE 33



DE-1988  
WHITE 34



DE-1989  
WESTCOTT 21



DE-1990  
WESTCOTT 21B



DE-1991



DE-1992



DE-1993  
WHITE



DE-1994  
WHITE





DE-1995



DE-1996



DE-1997



DE-1998



DE-1999



DE-2000



DE-2001



DE-2002



DE-2003



DE-2004  
PLANATOR



DE-2005  
PLANATOR



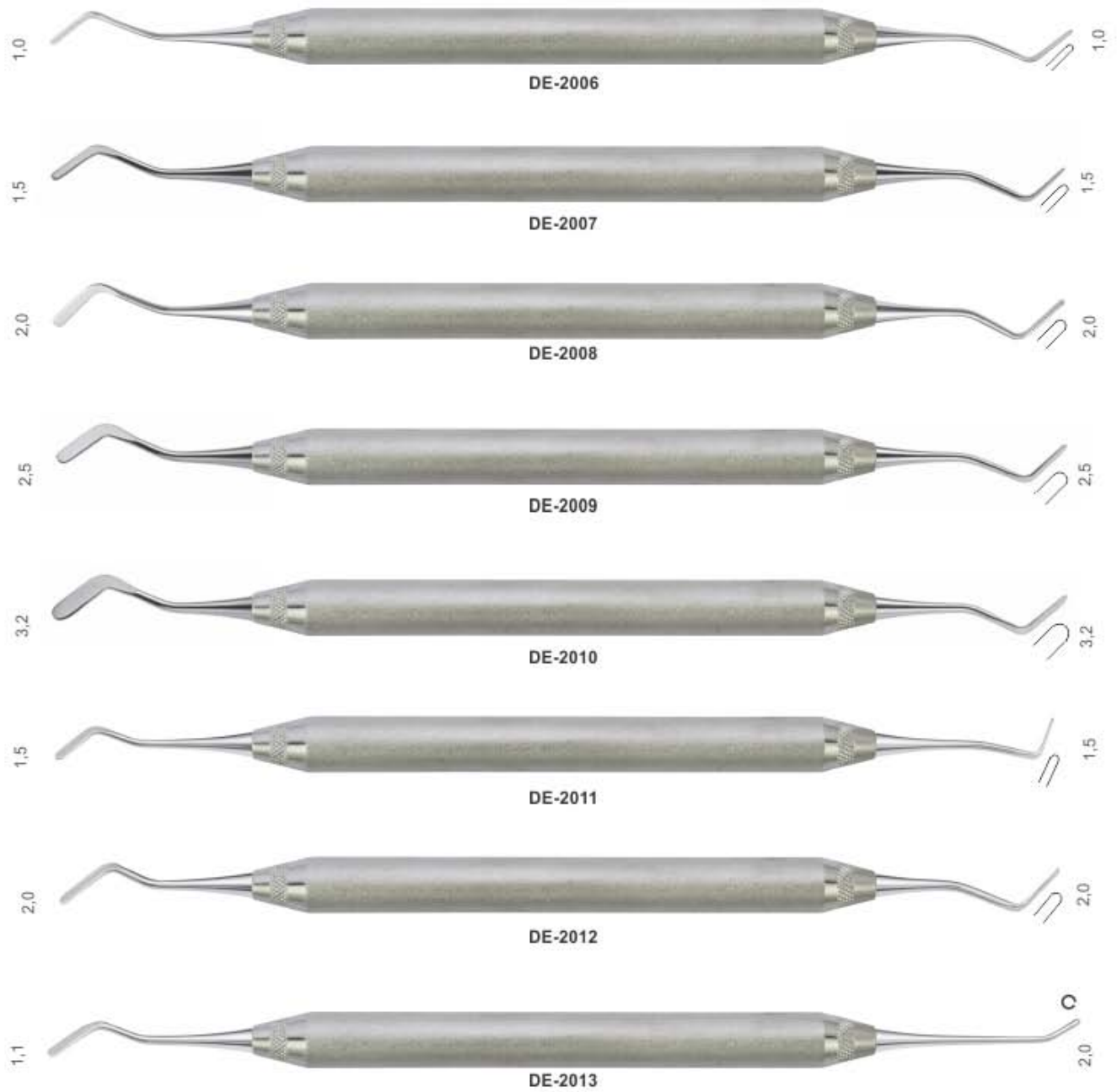

**BURNISHERS CONSERVATIVE TREATMENT**

**Ball Burnishers**



DE-2014



DE-2015



DE-2016



DE-2017



**Hatches**



DE-2018



DE-2019



DE-2020  
Mini-Spatel



DE-2021  
Mini-Spatel

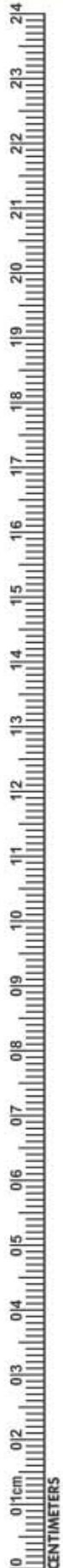

COMPOSITE INSTRUMENTS

Spatulas rounded and sharp

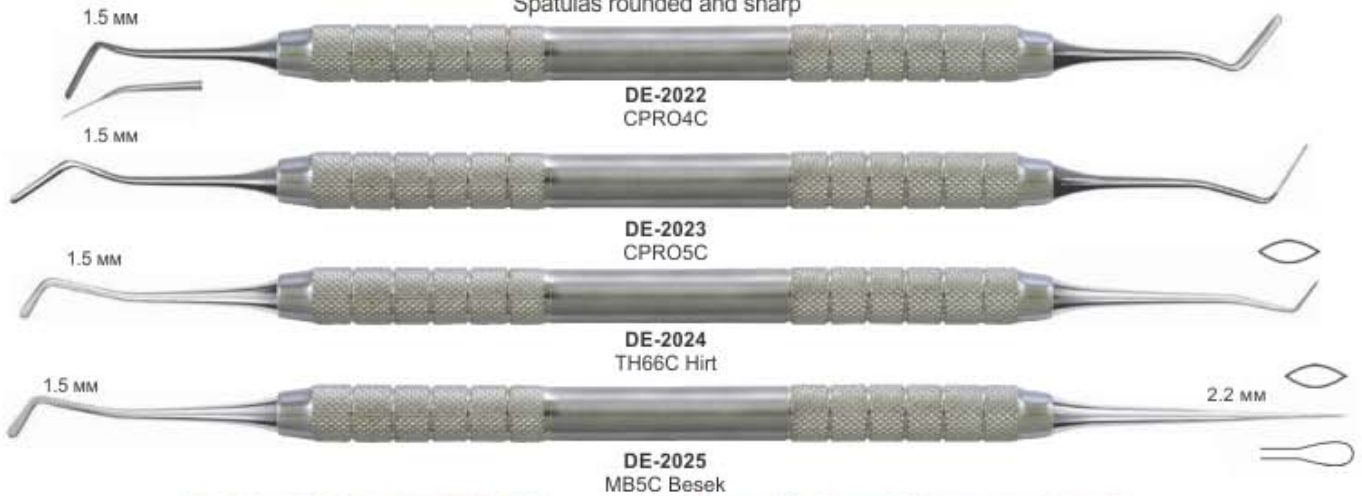

Spatulas Blade Thickness 0.22 MM

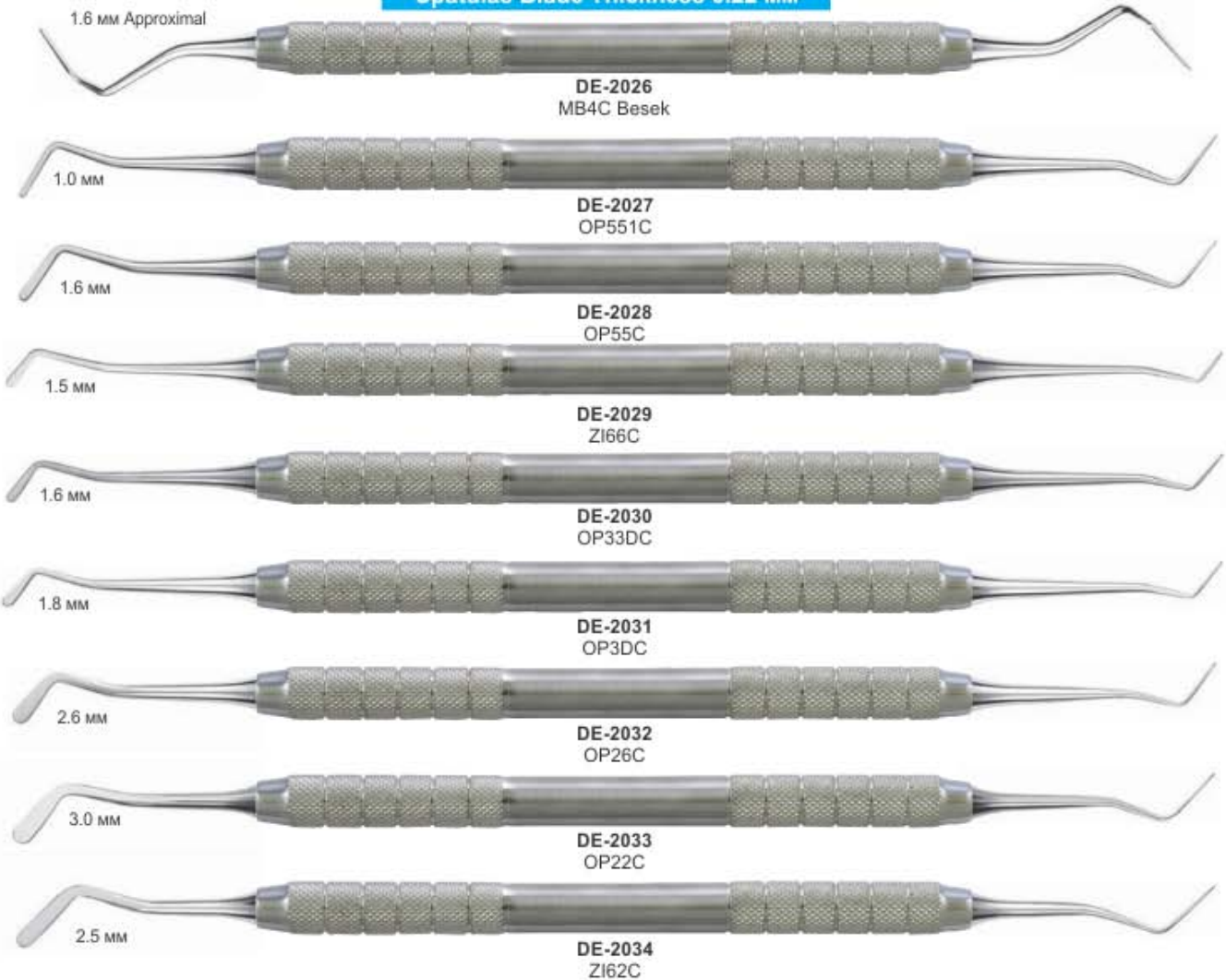



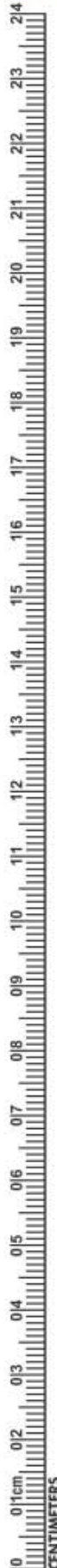

Spatulas



Spatulas-Pluggers



EXCAVATOR INSTRUMENTS

Water drop Our excavators have particularly sharp blades, free of burrs and perfectly rounded.

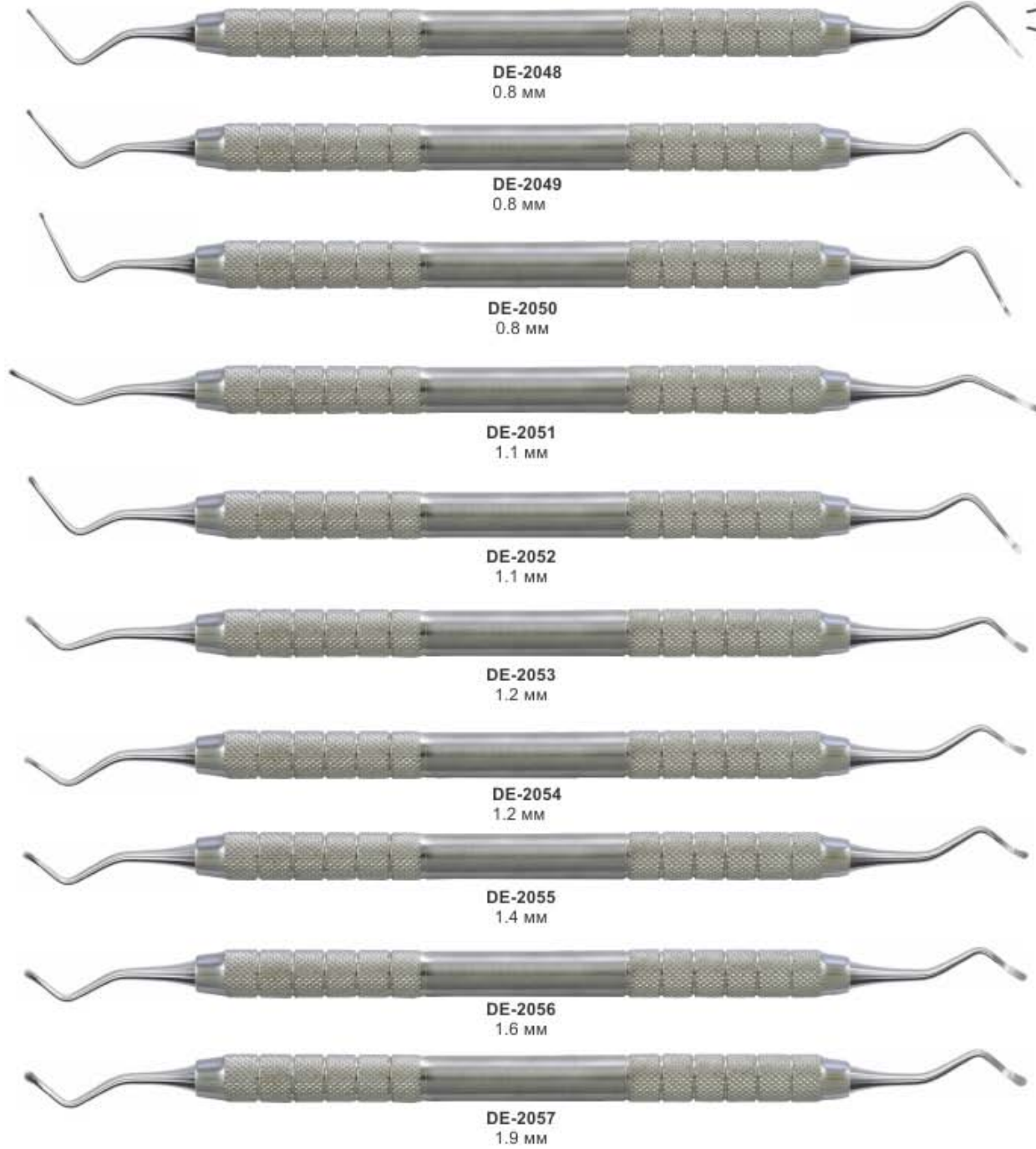

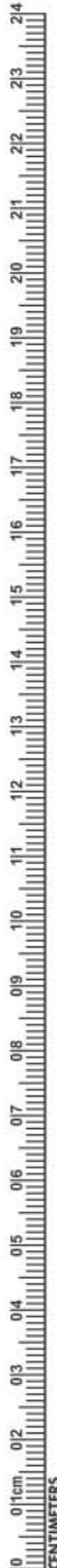

DE-2058



DE-2059



DE-2060



DE-2061



DE-2062



DE-2063



DE-2064



DE-2065

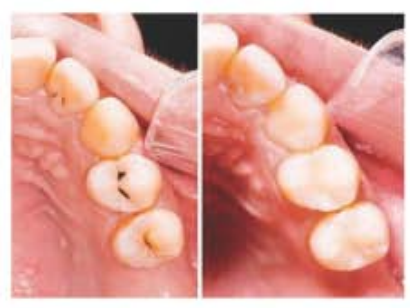

COMPOSITE BALL PLUGGERS

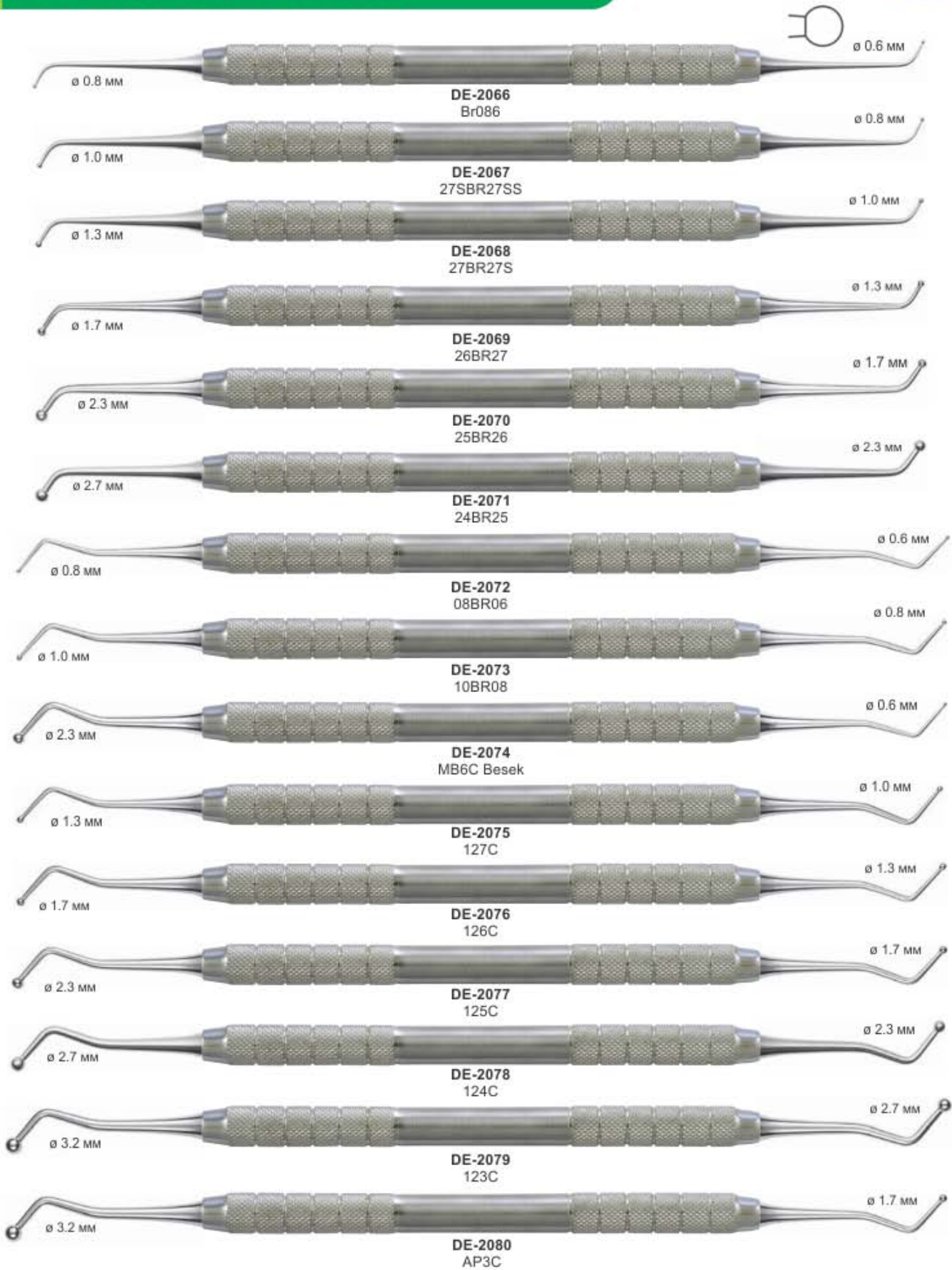

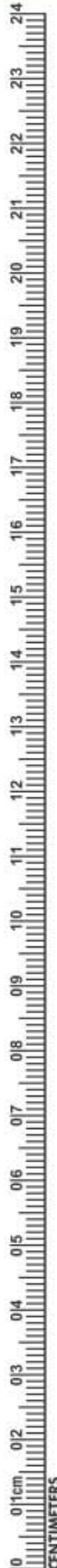

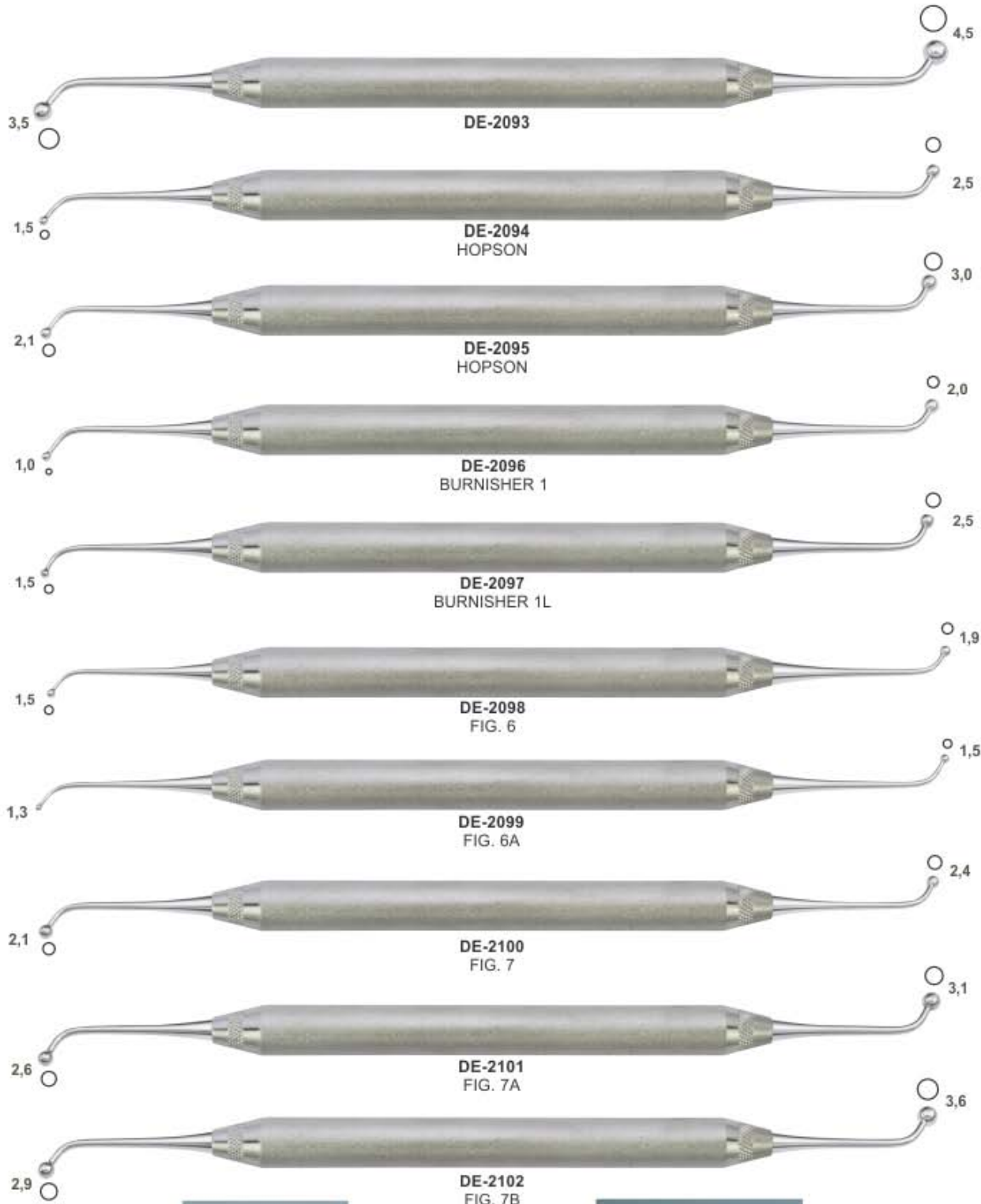

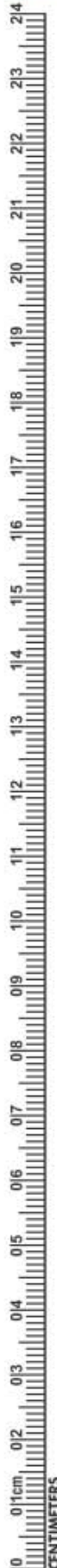

DE-2103



DE-2104



DE-2105



DE-2106



DE-2107



DE-2108

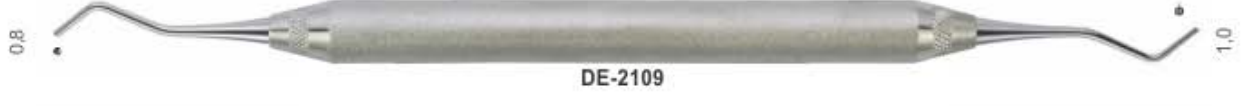

DE-2109



DE-2110



DE-2111



DE-2112



DE-2113



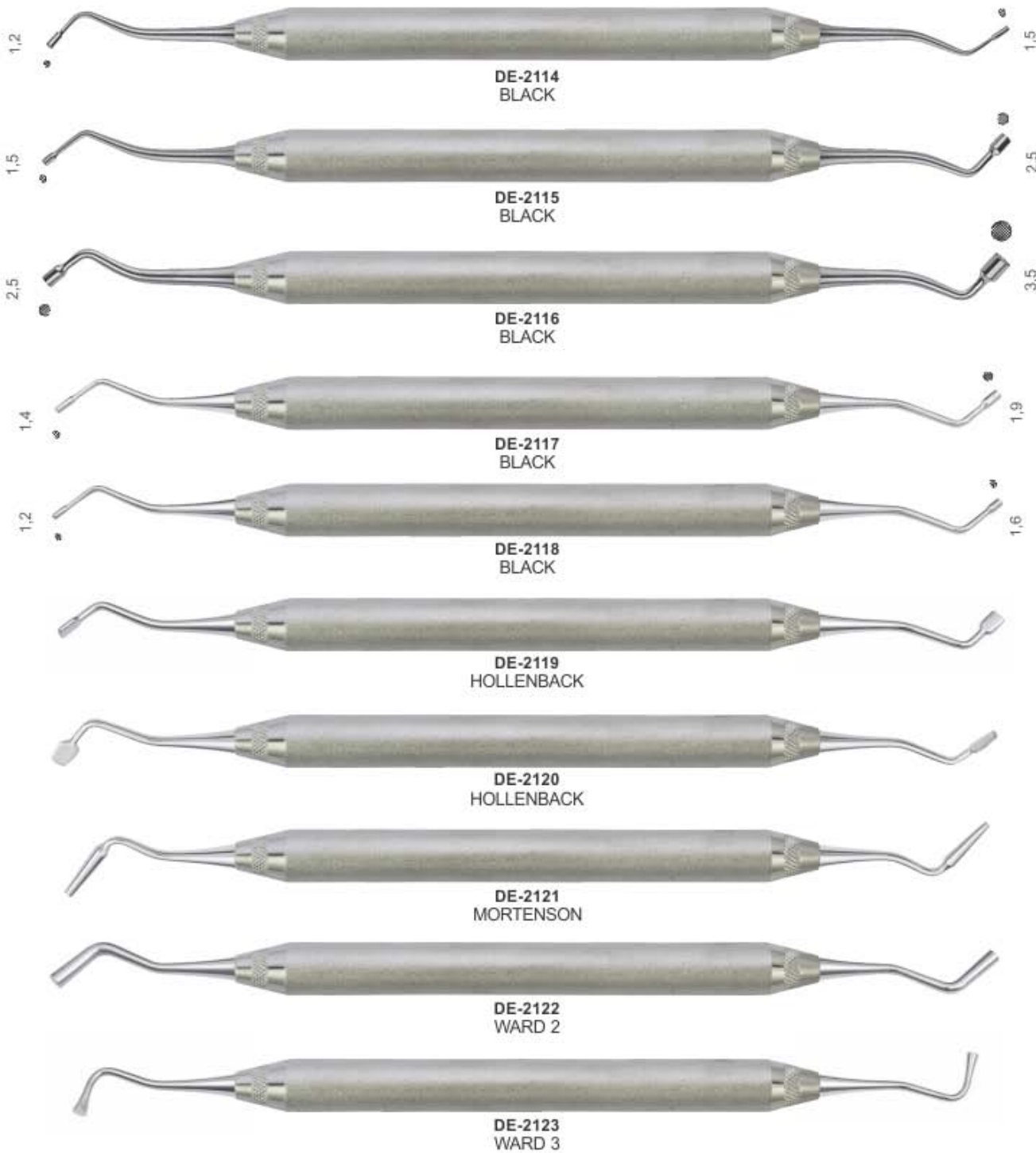





DE-2124  
WILLIAMS



DE-2125  
WILLIAMS



DE-2126  
WILLIAMS



DE-2127



DE-2128



DE-2129



DE-2130



DE-2131



DE-2132



DE-2133

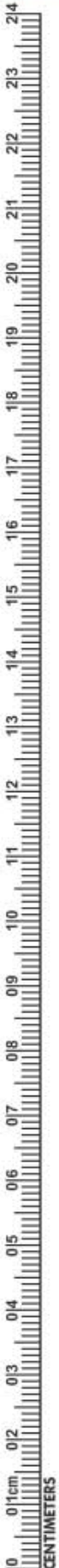

**CARVERS INSTRUMENTS**

- Инструменты для реставрации
- Instruments a modeler
- Modellierinstrumente
- Инструменти для реставрації
- Instrumentos para modelar
- أدوات تقطيع

**P.K. THOMS WAXING INSTRUMENTS SOLID HANDLE 6mm**

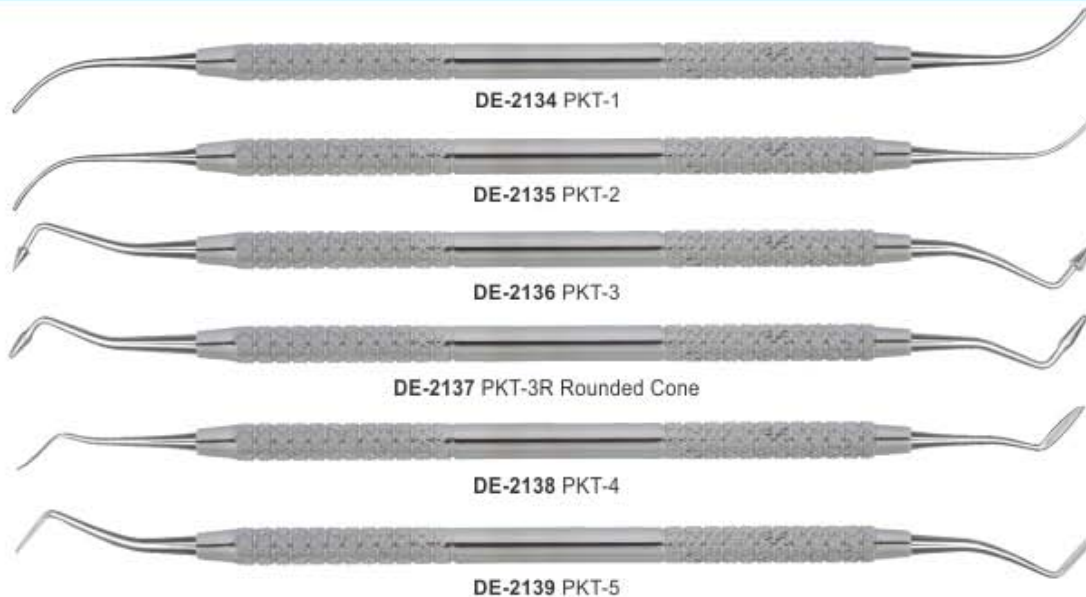

**DE-2140**  
Composite Instruments Blue  
Titanium with Cassettes



**DE-2141**  
P.k. Thomas Waxing Instruments Kit

**COMPOSITE INSTRUMENTS TITANIUM BLUE ENDODONTIC**

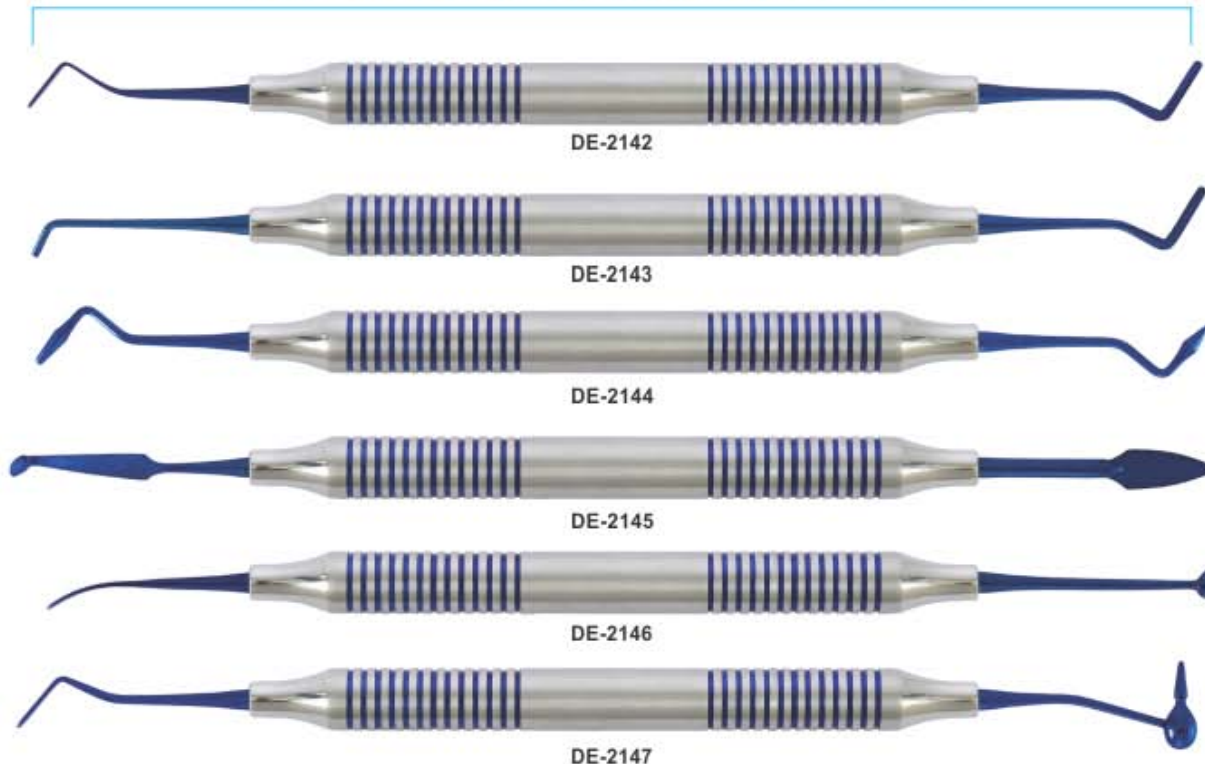

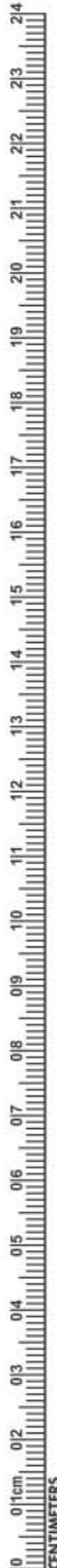

**DE-2148** Adult Palatal /  
**DE-2149** Child Palatal



**DE-2150**  
Buccal



**DE-2151** Adult Palatal /  
**DE-2152** Child Palatal



**DE-2153** Adult Palatal /  
**DE-2154** Adult Buccal



**DE-2155** Lingual upper /  
**DE-2156** Lingual Lower

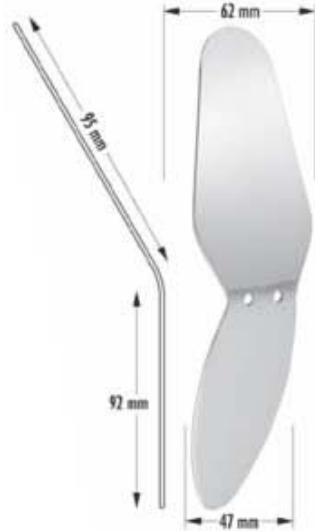

**DE-2157** Adult Buccal /  
**DE-2158** Child Buccal



**DE-2159** Child Palatal /  
**DE-2160** Child Buccal



**DE-2161**  
Palatal-Adult



**DE-2162**  
Palatal-Adult Large



**DE-2163**  
Palatal-Child



**DE-2164**  
Buccal-Small



**DE-2165**  
Buccal



**DE-2166**  
Lingual



**DE-2167**  
Lingual-Large

**NEEDLE HOLDERS**

- Иглодержатели
- Porte-aiguilles
- Nadelhalter
- Голкотримачи
- Porta-agujas
- اصحاب ابرة



DE-2168  
Lichtenberg-  
Ryder T.C  
14 cm



DE-2169  
Lichtenberg-  
Ryder T.C  
14 cm



DE-2170  
Lichtenberg-  
Ryder T.C  
17 cm



DE-2171  
Lichtenberg-  
Ryder T.C  
17 cm



DE-2172  
Barraquer  
18 cm



DE-2173  
Barraquer  
18 cm



DE-2174  
Barraquer T.C  
18 cm



DE-2175  
Barraquer T.C  
18 cm



DE-2176  
Tönnis  
18 cm



DE-2177  
Castroviejo  
13 cm  
Straight



DE-2178  
Kalt Needle Holders T.C  
14 cm Straight



DE-2179  
Peet Splinter Forceps  
11.5 cm

DE-2180  
La Grange  
Curved



DE-2181  
All-Purpose Pliers



RUBBER DAM CLAMPS KITS

- Резиновая дамба зажимы комплекты
- Trousses de caoutchouc
- Gummidammklammern
- Гумова дамба затискачі комплекти
- Conjuntos de abrazaderas de retención de caucho
- المطاط المد المشابك مجموعات



DE-2182

Stainless Steel Gold Plated Rubber Dam Clamp Tray with 11 Different Clamps  
Fig. 212, 211, 8, 8A, 14, 14A, 0, 00, 2, 2A, 7



DE-2183

Stainless Steel Rubber Dam Clamp Tray with 12 Different Clamps  
Fig. 209, 212, 211, 8, 8A, 14, 14A, 0, 00, 2, 2A, 7



DE-2184

Stainless Steel Rubber Dam Clamp Tray with 8 Different Clamps  
Fig. 1, 26, 29, 51, 60, 202, 205, 210



DE-2185

Stainless Steel Rubber Dam Clamp Tray  
(without clamps)

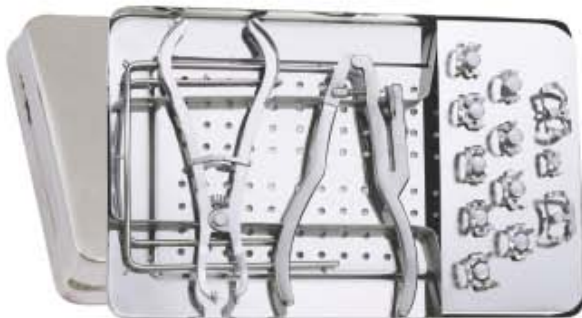

DE-2186

On request the Content of the rubber dam kit can be changed with other instruments.

**Content:**

- |                              |                              |
|------------------------------|------------------------------|
| 01 Ivory                     | 08 Rubber Dam Clamp Fig. 209 |
| 02 Ivory light weight        | 09 Rubber Dam Clamp Fig. 212 |
| 03 Clamps Stand              | 10 Rubber Dam Clamp Fig. 211 |
| 04 Rubber Dam Frame M        | 11 Rubber Dam Clamp Fig. 8   |
| 05 Rubber Dam Frame L        | 12 Rubber Dam Clamp Fig. 8A  |
| 06 Rubber Dam Box Lower Case | 13 Rubber Dam Clamp Fig. 14  |
| 07 Rubber Dam Box Upper Case | 14 Rubber Dam Clamp Fig. 14A |
|                              | 15 Rubber Dam Clamp Fig. 0   |
|                              | 16 Rubber Dam Clamp Fig. 00  |
|                              | 17 Rubber Dam Clamp Fig. 2   |
|                              | 18 Rubber Dam Clamp Fig. 2A  |
|                              | 19 Rubber Dam Clamp Fig. 7   |

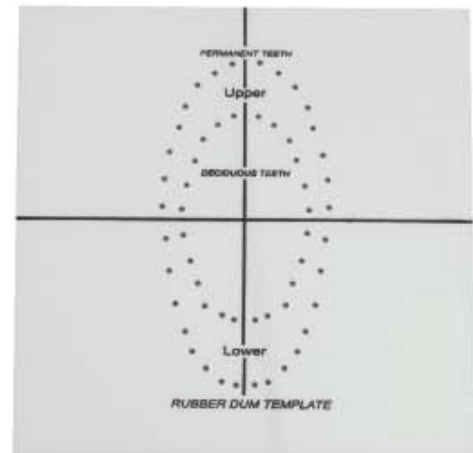

DE-2187

Rubber Dum Template

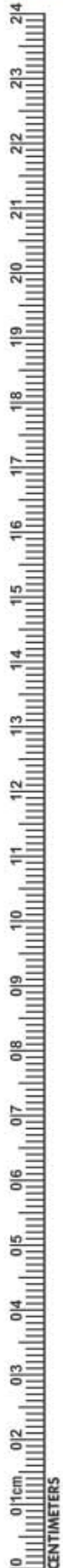

PERIODONTAL INSTRUMENTS

- Инструменты пародонтологические
- Instruments pour la parodontologie
- Instrumente für die Parodontologie
- Инструменти пародонтологічні
- Instrumentos para periodoncia
- الصكوك اللثة

To separate tissue tooth or bone. tp hold tissue away from surgical site.



- Инструменты пародонтологические
- Instruments pour la parodontologie
- Instrumente für die Parodontologie
- Інструменти пародонтологічні
- Instrumentos para periodoncía
- الصكوك اللثة

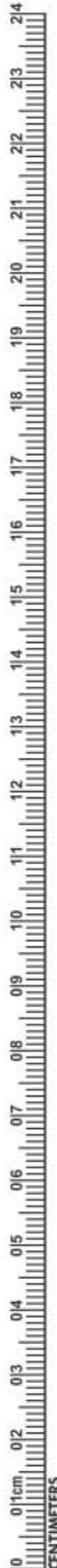

DE-2198



DE-2199  
P24G



DE-2200  
titanium Periosteal Elevator for Implan5



DE-2201  
S1



DE-2202  
Hirschfeld



DE-2203  
9S



10mm

DE-2204  
Selden

13mm

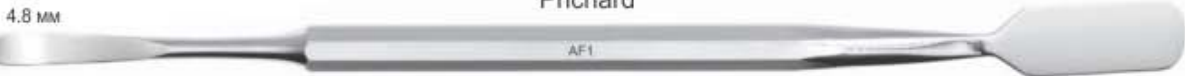

4.8 mm

Prichard

AF1

10.6 mm

DE-2205  
Friedmann



DE-2206  
Schmidlin

6.9 mm



**DE-2207**  
Metal tip  
220 mm  
Hammer With Wooden Handle



**DE-2208**  
Metal tip  
220 mm



**DE-2209**  
1  
For plaster



**DE-2210**  
2  
For metal



**DE-2211**  
Fret saw  
250 mm



**DE-2212**  
Small  
Saw Blades



**DE-2213**  
Large  
Saw Blades



**DE-2214**  
Ceri Saw



Special Inox  
**DE-2215** 170mm  
**DE-2216** 200mm



**DE-2217**  
Plaster Shears  
200 mm



Crucible Tongs  
**DE-2218** 250 mm  
**DE-2219** 320 mm



**DE-2220**  
Ceri Saw  
180 mm



**DE-2221**  
Blade  
0,12x5 mm  
Conf. 12 pcs



**DE-2222**  
Blade  
0,25x5 mm  
Conf. 12 pcs



**DE-2223**  
Blade  
0,25x3 mm  
Conf. 12 pcs



**DE-2224**  
Strip Saw



**DE-2225**  
Endo Finger Ruler  
Span Measure Scale





AMALGAM INSTRUMENTS

- Инструменты для амальгамы
- Instruments pour amalgame
- Amalgam-Instrumente
- Инструменти для амальгами
- Instrumentos para amalgama
- الصكوك الملقم

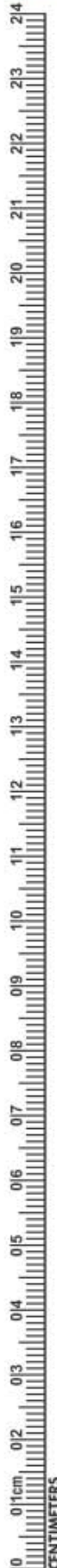

**DE-2226**  
Fig. 10  
165mm  
English pattern



**DE-2227**  
Fig. 1  
185mm  
German pattern



**DE-2228**  
Fig. 1  
150mm  
Swiss pattern



**DE-2229**  
Fig. 1  
150mm



**DE-2230**  
Fig. 2  
150mm, 45°



**DE-2231**  
Fig. 3  
140mm, 90°



**DE-2232**  
Chip Blower



**DE-2233**



**DE-2234**



**DE-2235**



**DE-2236**  
Water Syringe



DE-2237 DE-2238 DE-2239 DE-2240



DE-2241  
4mm  
(Straight)



DE-2242  
4mm  
(Curved)



DE-2243  
6mm  
(Straight)



DE-2244  
6mm  
(Curved)

Periodontal Chisels



7.5mm



DE-2245



4.5mm



DE-2246



7.5mm



DE-2247



4.5mm



DE-2248



SCALPEL HANDLES

- Ручки для скальпелей
- Manches de bistouris
- Skalpellgriffe
- Ручки для скальпелів
- Mangos de bisturi
- مشرط مقابض



DE-2249  
Fig.3  
12.7cm



DE-2250  
Fig.3G  
12.7cm



DE-2251  
Fig.4  
13.7cm



DE-2252  
Double Handle  
No.4 + No.3  
16.3cm



DE-2253  
Fig. 7  
16.5cm



DE-2254  
Scalpel Handle Straight  
for blades #10-15  
14.5cm



DE-2255  
Micro Surgical Scalpel  
Handle titanium  
13.5cm



DE-2256  
Fig. 5  
14.5cm



DE-2257  
Fig. 5A  
14.5cm



DE-2258  
6 Way Adjustable Angled  
Scalpel Handle



**ORTHODONTIC INSTRUMENTS**

- Инструменты ортодонтические
- Instrumentos Ortodonticos
- Orthodontische Instrumente
- Инструменти ортодонтични
- Instruments Orthodontiques
- أدوات تقويم الأسنان



**DE-2259**  
Boley Gauge



**DE-2260**  
Vernier Gauge



**DE-2261**  
Alluminium Caliper  
up to 200mm



**DE-2262**  
Boley Gauge



**DE-2263**  
Delux Boley  
Gauge



**DE-2264**  
Beerendonk  
130mm  
Mini Gauge



**DE-2265**  
Compasso  
De Willis



**DE-2266**  
Dentaurum  
Ruler



**DE-2267**  
Ruler Wedge



**DE-2268**  
Ruler



ORTHODONTIC INSTRUMENTS

- Инструменты ортодонтические
- Instrumentos Ortodonticos
- Orthodontische Instrumente
- Инструменти ортодонтични
- Instruments Orthodontiques
- ابوات تلويم الاسنان



**DE-2269**  
Band seater  
auto cleavable



**DE-2270**  
Band seater  
auto cleavable  
Triangle Shape



**DE-2271**  
Band seater  
auto cleavable  
Square Shape



**DE-2272**  
Band seater  
auto cleavable  
Round Shape



**DE-2273**  
Mershon Band  
Pusher  
140mm



**DE-2274**  
Band seating &  
removing  
instruments



**DE-2275**  
Ortho Light double  
ended  
ligature director  
scaler



**DE-2276**  
Ortho Light Band  
Pusher Scaler



**DE-2277**  
Band Seating &  
Removing  
Silicon Grip



**DE-2278**  
Ligature Instrument  
Silicon Grip



**DE-2279**  
Elastic Instrument  
Silicon Grip



**DE-2280**  
Distal Bender  
Silicon Grip



**DE-2281**  
Distal Bender  
Silicon Grip



**DE-2282**  
Distal Bender  
Silicon Grip



ORTHODONTICS PLIERS STANDS

- Ортодонтия Щипцы Подставки
- Supports de pinces d'orthodontie
- Kieferorthopädie Zangenständer
- Ортодонтия Щипці Підставки
- KFO Zangen Ständer
- تقويم الأسنان كماله تنطق

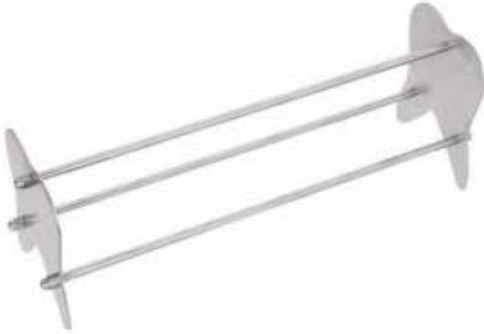

**DE-2283**  
Plier Stand  
Stainless Steel.



**DE-2284**  
Plier Stand  
Stainless Steel.



**DE-2285**  
Pliers Stand  
Stainless Rod  
(Aluminum Anodized)  
Stainless Steel



**DE-2286**  
Plier Stand  
Stainless Steel.



**DE-2287**  
Plier Stand  
Stainless Steel.



**DE-2288**  
Plier Stand  
Plastic



- Инструменты для имплантологии
- Implantologie
- Implantologie

- Інструменти для імплантології
- Implantologia
- زراعة الأسنان

Composite Filling Instruments Set of 6 Pcs



DE-2289



DE-2290



DE-2291



DE-2292



DE-2293



DE-2294

COMPOSITE INSTRUMENTS USE:

A composite (tooth colored) filling is used to repair a tooth that is affected by decay, cracks, fractures, etc. The decayed or affected portion of the tooth will be removed and then filled with a composite filling.

There are many types of filling materials available, each with their own advantages and disadvantages. You and your dentist can discuss the best options for restoring your teeth. Composite fillings, along with silver amalgam fillings, are the most widely used today. Because composite fillings are tooth colored, they can be closely matched to the color of existing teeth, and are more aesthetically suited for use in front teeth or the more visible areas of the teeth.

As with most dental restorations, composite fillings are not permanent and may someday have to be replaced. They are very durable, and will last many years, giving you a long lasting, beautiful smile.

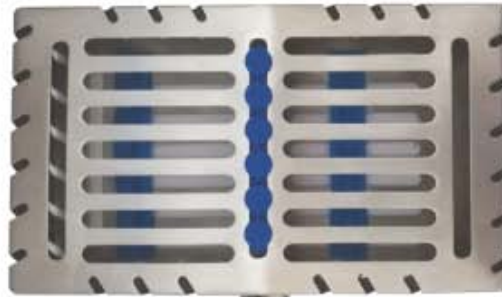

DE-2295



IMPLANTOLOGY

- Инструменты для имплантологии
- Implantologie
- Implantologie
- Инструменти для імплантології
- Implantoloia
- زراعة الأسنان

Set of 5 Composite Gold Tip Instruments  
DE-2296



Set of 4 Composite Blue Tip Instruments  
DE-2297



Set of 3 Composite Blue Tip Instruments  
DE-2298



Set of 2 Composite Blue Tip Instruments  
DE-2299



DE-2300 Periosteal Elevators Molt # 9

DE-2301 Endodontic explorer DG # 16





- Инструменты для имплантологии
- Implantologie
- Implantologie

- Інструменти для імплантології
- Implantologia
- زراعة الأسنان

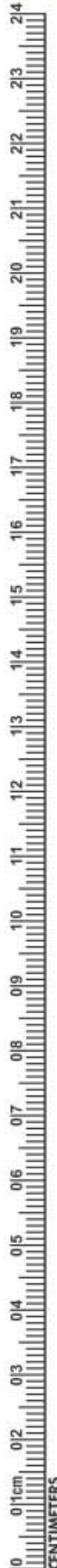

**DE-2302**  
Sinus Lift elevator 1



**DE-2303**  
Sinus Lift elevator 2



**DE-2304**  
Sinus Lift elevator 3



**DE-2305**  
Sinus Lift elevator 4



**DE-2306**  
Sinus Lift elevator 5



**DE-2307**  
Sinus Lift elevator 6



**DE-2308**  
Sinus Lift Elevators Set of 7 Pcs  
with cassette

**IMPLANTOLOGY**

- Инструменты для имплантологии
  - Implantologie
  - Implantologie
- Инструменти для імплантології
  - Implantologia
  - زراعة الأسنان

**Sinus Left Elevator Set of 10 Pcs**

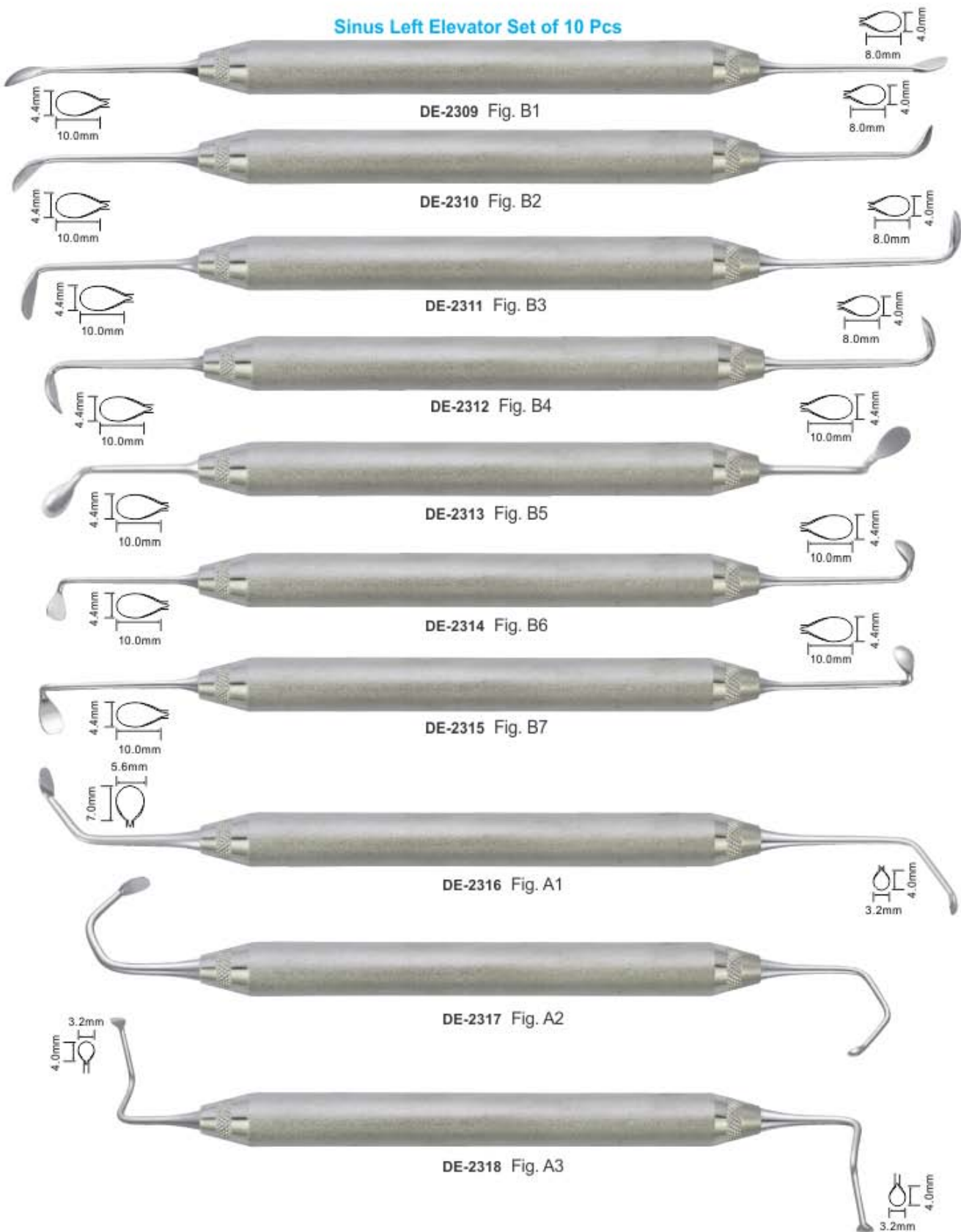

- Инструменты для имплантологии
- Implantologie
- Implantologie

- Инструменти для імплантології
- Implantologia
- زراعة الأسنان

IMPLANT SINUS LIFT INSTRUMENTS HOLLOW HANDLE 9.5MM LENGTH 170MM

SINUS LIFT INSTRUMENTS HOLLOW HANDLE 9.5MM LENGTH 170MM

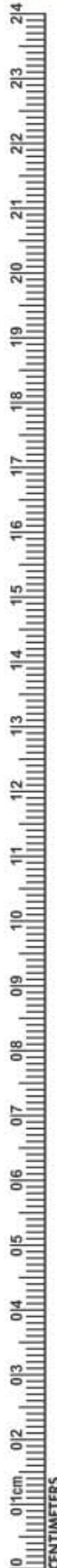

DE-2319  
Acute 6577



DE-2320  
Sinus 1

DE-2321  
Sinus 2

DE-2322  
Sinus 3  
Obtuse 6578

DE-2323  
Sinus 4

DE-2324  
Sinus 5

DE-2325  
Sinus 6

DE-2326  
Sinus 7



9 Pcs of Set  
DE-2327



DE-2328  
Sinuslift 1



DE-2329  
Sinuslift 2

DE-2330  
Sinuslift 3

DE-2331  
Sinuslift 4

DE-2332  
Sinuslift 5

DE-2333  
Sinuslift 6

DE-2334  
Membrane  
3Positioning 1

DE-2335  
Condenser 1



9 Pcs of Set  
DE-2336

**IMPLANTOLOGY**

- Инструменты для имплантологии
- Implantologie
- Implantologie
- Инструменти для імплантології
- Implantologia
- زراعة الأسنان

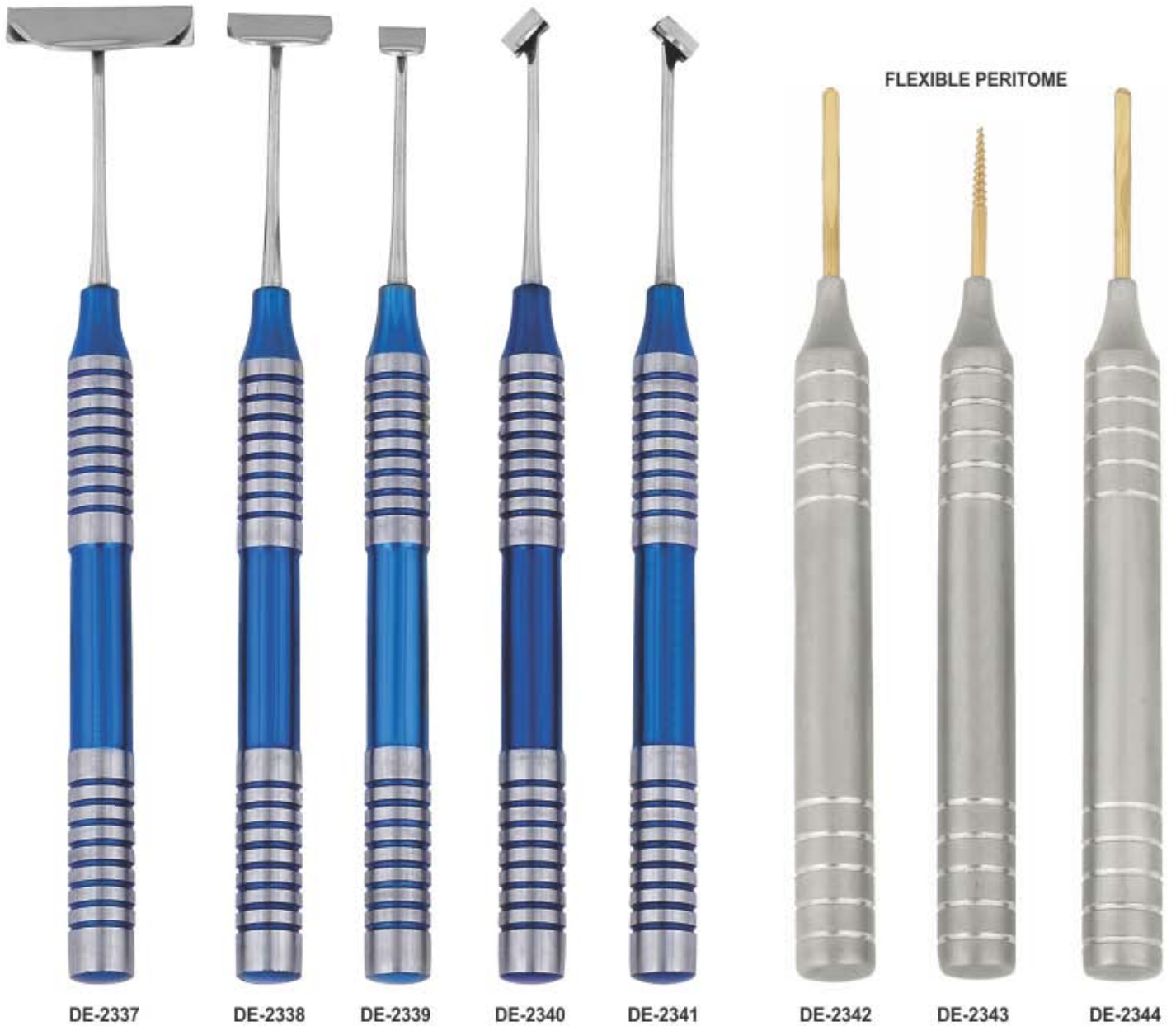

Soft Brushing Kit Set of 6 Pcs



- Инструменты для имплантологии
- Implantologie
- Implantologie

- Інструменти для імплантології
- Implantologia
- زراعة الأسنان

SINUS ELEVATOR & MEMBRANE LIFT TIPS

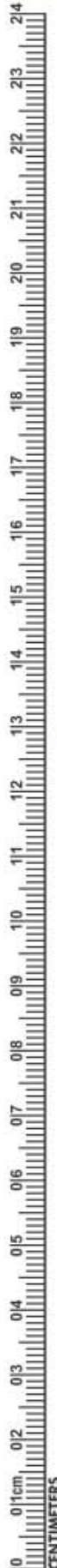

**DE-2345**  
Membrane Detach Elevator



**DE-2346**  
Membrane Elevator



**DE-2347**  
Membrane Elevator



**DE-2348**  
Membrane Elevator



**DE-2349**  
Membrane Elevator



**DE-2350**  
Bone Graft Packer



**DE-2351** Pt2 Titanium  
A/V Regular



**DE-2352** Pt1 Titanium  
A/V Regular



**DE-2353** Pt3 Titanium Angel S/E



**DE-2354** Pt4 Titanium STR S/E



**DE-2355** Pt5 Titanium TG CVD S/E



**DE-2356**  
Sinus Left Elevator & Membrane Lift Tips 3  
set of 7 Pcs

HOLLOWWARE INSTRUMENTS



Spirit Lamp  
DE-2357



Spirit Lamp  
DE-2358



Spirit Lamp  
DE-2359



Cotton Holding Jar  
DE-2360



Cotton Holder  
DE-2361



Cotton Holder  
DE-2362



Cotton Wool Dispenser Acc.  
to Methot  
DE-2363



Needle Sterilization Tub  
DE-2364



Round Endodontic Boxes  
complete with lid  
DE-2365 Ø mm. 94 - h. mm. 70



Endodontic Box  
DE-2366



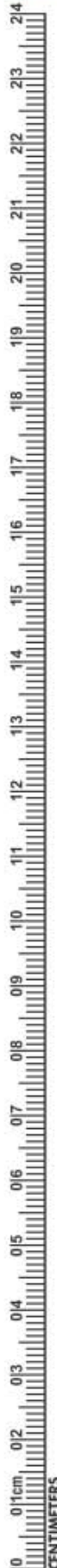

**DE-2367**  
100 x 180 x 11mm  
Mini size



**DE-2368**  
100 x 180 x 11mm  
Mini size



**DE-2369**  
100 x 180 x 11mm  
Mini size



**DE-2370**  
100 x 180 x 11mm  
Mini size



**DE-2371**  
100 x 180 x 11mm  
Mini size



Lid  
Coperchio

**DE-2372**  
103 x 182 x 10mm  
Mini size



**DE-2373**  
Silver



**DE-2374** Blue  
**DE-2375** Red



**DE-2376** Blue  
**DE-2377** Red



**DE-2378**  
Silver



**DE-2379**  
Green



**DE-2381**  
Blue



**DE-2380**  
Golden



**DE-2382**  
Red



**DE-2383**  
Silver



**DE-2384**  
Midi  
125 x 105 x 54mm



**DE-2385**  
Maxi  
204 x 105 x 54mm

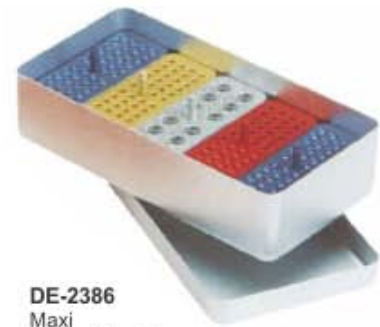

**DE-2386**  
Maxi  
204 x 105 x 54mm

**HOLLOWARE INSTRUMENTS**

**STERILIZING MESH TRAY**

Different sizes & dimensions are available at buyer's demand



**MESH TRAYS**  
**DE-2387**  
Different sizes & dimensions are available at buyer's demand



**MESH TRAYS**  
**DE-2388**  
05 Pcs



**MESH TRAYS**  
**DE-2389**  
07 Pcs



**MESH TRAYS**  
**DE-2390**  
10 Pcs



**MESH TRAYS**  
**DE-2391**  
20 Pcs



**DE-2392**  
Mesh Cassettes  
5 Pieces, 7 Pieces, 10 Pieces,  
15 Pieces & 20 Pieces



**MESH TRAY**  
DE-2393 240x130x50mm  
DE-2394 240x130x60mm  
DE-2395 240x250x50mm  
DE-2396 240x250x60mm  
DE-2397 480x250x50mm  
DE-2398 480x250x60mm  
DE-2399 480x250x70mm



**MESH TRAY**  
DE-2400 240x250x 50mm  
DE-2401 240x250x 60mm  
DE-2402 240x250x 70mm  
DE-2403 480x250x 50mm  
DE-2404 480x250x 60mm  
DE-2405 480x250x 70mm  
DE-2406 480x250x100mm



**MESH TRAY**  
DE-2407 240x250x50mm  
DE-2408 240x250x60mm  
DE-2409 240x250x70mm  
DE-2410 280x250x50mm  
DE-2411 280x250x60mm



**MESH TRAY**  
DE-2412 280x250x 70mm  
DE-2413 280x250x100mm  
DE-2414 280x250x 50mm  
DE-2415 280x280x 60mm  
DE-2416 280x280x 70mm  
DE-2417 300x280x 60mm





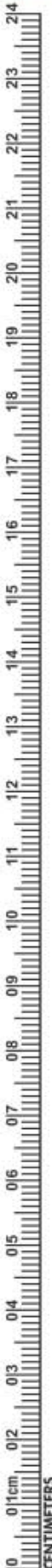

DE-2418 Implant Basic Starter Kit 11 instruments with case



DE-2419 Crown Bridge Set Instruments with Case



DE-2420 Bone Curettes Spoon Style set of 4 with Metal Case



DE-2421 Peritome Set of 2 with Blue Nitrate Tips and Metal Case



DE-2422 Root Fragment Removal elevators, Set of 4 with Metal Case



DE-2423 Peritome Set of 3 Gold Handles Serrated Blades with Metal Case

# EXPLORERS

- Зонды
- Sondes
- Zahnsonden
- Зонди
- Sondas
- المستكشفين

## PROBES

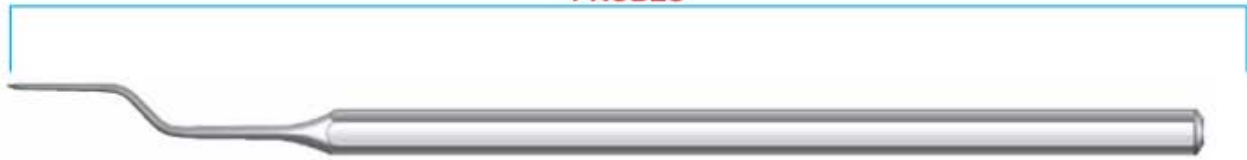

DE-2424  
Probe



DE-2425  
Probe



DE-2426  
Probe



DE-2427  
Probe



DE-2428  
Probe



DE-2429  
Probe



DE-2430  
Probe



DE-2431  
Probe



- Инструменты пародонтологические
- Instruments pour la parodontologie
- Instrumente für die Parodontologie

- Інструменти пародонтологічні
- instrumentos para periodoncia
- الصكوك اللثة

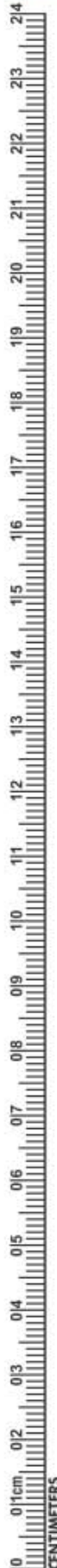

**DE-2432**  
Excavator



**DE-2433**  
Excavator



**DE-2434**  
Excavator



**DE-2435**  
Filling Instruments



**DE-2436**  
Filling Instruments



**DE-2437**  
Filling Instruments



**DE-2438**  
Filling Instruments



**DE-2439**  
Filling Instruments



**DE-2440**  
Cement Spatula

# PERIODONTAL INSTRUMENTS

- Инструменты пародонтологические
- Instruments pour la parodontologie
- Instrumente für die Parodontologie

- Інструменти пародонтологічні
- instrumentos para periodoncia
- الصكوك اللثة

## MODELLING INSTRUMENTS



- Инструменты пародонтологические
- Instruments pour la parodontologie
- Instrumente für die Parodontologie

- Инструменти пародонтологічні
- instrumentos para periodoncia
- الصكوك اللثة

**Periodontal Instruments Set**



Cotton Meriam Tweezer

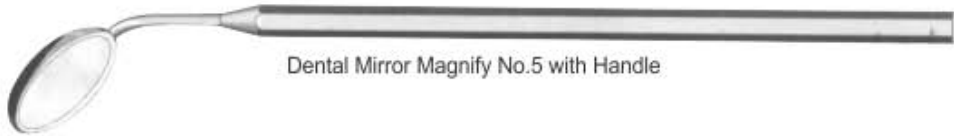

Dental Mirror Magnify No.5 with Handle

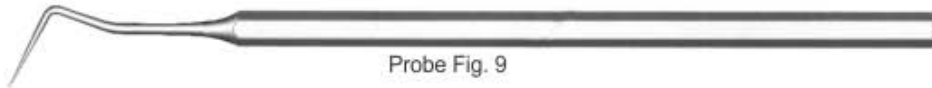

Probe Fig. 9

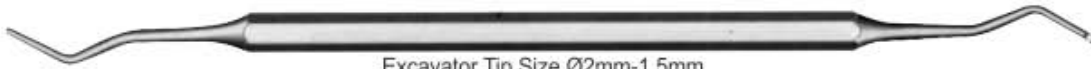

Excavator Tip Size Ø2mm-1,5mm



Excavator Tip Size Ø1,2mm-1,5mm



Plugger Tip Size Ø1,5mm-2mm



Plugger Tip Size Ø2mm-2,5mm



Ironing Crescent Tip Size Ø3mm-3,2mm



Ironing Crescent Tip Size Ø2,5mm-2,5mm



Cement Spatula Tip Size 6mm



**DE-2449**  
Set of 10 Pieces.



DENTAL INSTRUMENTS SETS



(also available in color coated)  
DE-2450 PDL Elevators (Set of 7-Pcs.)



DE-2451  
Examination  
Set of 3-Pcs.



DE-2452  
Examination  
Set of 3-Pcs.



DE-2453  
Examination  
Set of 3-Pcs.



DE-2454 Dental Lab Instruments Set of 10-Pcs.



DE-2455 Cleaning Kit of 10-Pcs.



DE-2456  
Dental Head Mirrors



DE-2457  
Dental Flasks Press



DE-2458  
Crown & Bridge Articulator



DE-2459  
Galetti adjustable Articulators



- DE-2460 Orthodontic Wire of 15 Meters Size: 0.4mm
- DE-2461 Orthodontic Wire of 15 Meters Size: 0.5mm
- DE-2462 Orthodontic Wire of 15 Meters Size: 0.6mm
- DE-2463 Orthodontic Wire of 15 Meters Size: 0.7mm
- DE-2464 Orthodontic Wire of 15 Meters Size: 0.8mm
- DE-2465 Orthodontic Wire of 15 Meters Size: 0.9mm
- DE-2466 Orthodontic Wire of 15 Meters Size: 1.0mm



Flexible Periotome Dental Extraction Screw  
DE-2467 Kit Luxating Elevators 6-Pcs. "ASIM Brand"



DE-2468  
Dental Lab  
Gas Burner



DE-2469  
Endo Finger  
Ruler



DE-2470 "ASIM'S  
Tunneling Forceps"  
For Pulling Tissue Graft Through Tunnel  
Micro Thin For Uninterrupted Passage  
Through Tunnel 75 Degree Angle For All  
Areas And Applications Pressure Limiting  
Spring Prevents Damage To Graft  
Diamond Coated For Slip Resistance



DE-2471  
Endo Finger  
Ruler



DE-2472 DE-2473  
Soldering Tweezers  
Serrated Tips Fiber  
Grip Heat Resistant



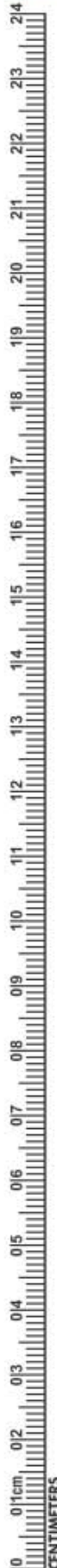

**DE-2474**  
Dental Anesthesia Syringe  
1.8 ml (in Multi Colors)

**DE-2475**  
Dental Anesthesia Syringe  
1.8 ml (in Multi Colors)

**DE-2476**  
Dental Anesthesia Syringe  
1.8 ml (in Multi Colors)



**DE-2477**  
Dental Syringe 1. ½ Ring  
Cork Screw Tip



**DE-2478**  
Dental Syringe -Ring  
Cork Screw Tip



**DE-2479**  
Knives for Wax



**DE-2480**  
Knives for Wax



**DE-2481**  
Spoon Curettes D\_end with Mash Point

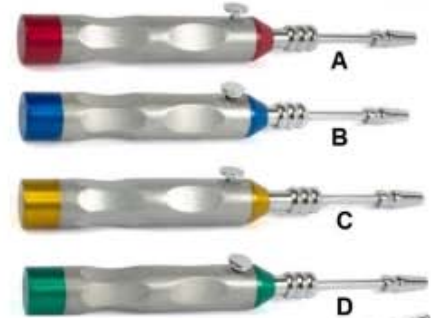

**A**

**B**

**C**

**D**



**DE-2482**  
Crown Remover



**DE-2483**  
Wire Cutter Pliers  
(screw joint)



**DE-2484**  
Wire Cutter Pliers  
(box joint)

DENTAL INSTRUMENTS



**DE-2485**  
Hair scissors 175mm



**DE-2486**  
Scissors For dressing  
235mm



**DE-2487**  
Dissecting Scissors, Intestinal, Straight, 205mm



**DE-2488**  
Dental Mallet (Brass)



**DE-2489**  
Dental Mallet (Brass)



**DE-2490**  
Root Fragments Forceps  
Fig.1 straight Fig.2 Curved



**DE-2491**  
Dental cutter  
for gypsum  
170mm RSG



**DE-2492**  
Dental Scissors 190mm



**DE-2493**  
Dental Spoon



**DE-2494**  
Neurological Mallets for  
the study of tendon Mallets



**DE-2495**  
Diamond Disks  
Safety Guard 7/8



**DE-2496**  
Heister Mouth Gag 5"



**DE-2497**  
Castrovieje Scleral Marker



**DE-2498** Zurich Measuring Caliper







**DE-2499** Scalpel Knife Large Cb 160x50



**DE-2500** Scalpel Knife Small Cbr 145x32



**DE-2501** Scalpel Knife Medium 150x42



**DE-2502** Scalpel Knife Medium Cb 150x40



**DE-2503** Scalpel Knife Medium 153x47



**DE-2504** Scalpel Knife, sharp-pointed medium 150x40



**DE-2505** Scalpel Knife 130x20 Cb-2 VP.



**DE-2506** Scalpel Knife 130x20 Cb-2



**DE-2507** Ophthalmic Scalpel sharp-pointed medium 130x20



**DE-2508** Resection Knife Convex 165x55



**DE-2509** Knife Costal Cartilage 205mm



**DE-2510** Amputation Knife, small 250x120



**DE-2511** Amputation Knife, Large 315x180



**DE-2512**  
Lucae Tweezers 14cm 140x1,5



**DE-2513**  
Lucae Kocher Tweezers 14cm 140x1,5



**DE-2514**  
14mm Physician  
Dental Dentist  
Laryngeal Mouth  
Mirror 8 mm



**DE-2515**  
Round Mirrors handle  
with Adjustment



**DE-2516**  
Physician Dental  
Dentist Laryngeal  
Mouth Mirror 12mm

**DE-2517**  
Physician Dental  
Dentist Laryngeal  
Mouth Mirror 15mm

**DE-2518**  
Physician Dental  
Dentist Laryngeal  
Mouth Mirror 21mm

**DE-2519**  
Physician Dental  
Dentist Laryngeal  
Mouth Mirror 25mm

**DE-2520**  
Physician Dental  
Dentist Laryngeal  
Mouth Mirror 27mm



**DE-2521**  
Chisel Otorhinolaryngological  
(4x150mm), wide Grove handle

**DE-2522**  
Chisel Otorhinolaryngological  
(2x150mm), wide Grove handle

**DE-2523**  
Chisel Otorhinolaryngological  
(4x150mm), wide Grove handle

**DE-2524**  
Chisel Otorhinolaryngological  
(6x150mm), wide Grove handle

**DE-2525**  
Chisel Otorhinolaryngological  
(8x150mm), wide Grove handle



**DE-2526**  
Adenotome No. 1



**DE-2527** Wire Probe Curved Sharp Blunt Point



**DE-2528** Wire Probe Curved Sharp Single Point



**DE-2529** Dental Probe Blunt Single Point





Russian Type Speculums

DE-2530 (small) Vaginal Speculum No.1

DE-2531 (Medium) Vaginal Speculum No.2

DE-2532 (Large) Vaginal Speculum No.3



DE-2533 Nasal Mirror 22mm

DE-2534 Nasal Mirror 30mm  
DE-2535 Nasal Mirror 35mm

DE-2536 Nasal Mirror 40mm  
DE-2537 Nasal Mirror 60mm



DE-2538 Uterine Tenaculum Forceps 250mm



DE-2539 Spoon Curettes Gynecologic double-ended



DE-2540 Volkman Gynecological Spoon, double-end



DE-2541 Curette No.1 DE-2542 Curette No.2 DE-2543 Curette No.3



DE-2544 Tongue Depressor (Double sided spatulas)



DE-2545 Russian Type Impression Trays Set of (6-Pcs.)

Impression Trays Upper  
DE-2546 No.1 Upper 1  
DE-2547 No.2 Upper 2  
DE-2548 No.3 Upper 3

Impression Trays Lower  
DE-2549 No.1 Lower 1  
DE-2550 No.2 Lower 2  
DE-2551 No.3 Lower 3

DE-2552 Vaginal Speculum Simsu No.1  
DE-2553 Vaginal Speculum Simsu No.2  
DE-2554 Vaginal Speculum Simsu No.3  
DE-2555 Vaginal Speculum Simsu No.4  
DE-2556 Vaginal Speculum Simsu No.5



DE-2557 Vaginal elevator-speculum OTTO (100x30)



DE-2558 Forceps Sponge Forester Str. & Cvd. 25cm / 12mm



DE-2559 Ear Funnel, nickel-plated No.1  
DE-2560 Ear Funnel, nickel-plated No.2  
DE-2561 Ear Funnel, nickel-plated No.3  
DE-2562 Ear Funnel, nickel-plated No.4

DE-2563 Spoon Curettes D\_End with Point 3mm, 3.5(Putty Cut)

DE-2564 Bone Chisels (Files) No.1 (3mm) No.1 (3mm)



DE-2565 Dental Chisel No.2 4mm



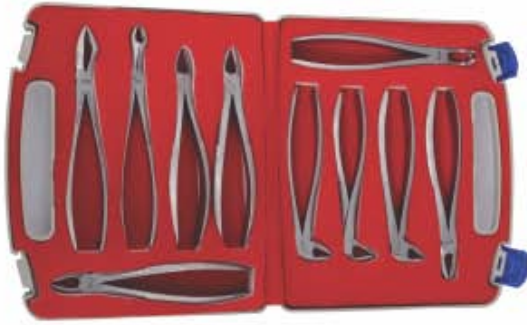

**DE-2566**  
Tooth Extracting  
Forceps UK-Type  
Set of 10 Pcs.  
Fig. 1  
Fig. 7  
Fig. 13  
Fig. 17  
Fig. 18  
Fig. 22  
Fig. 51A  
Fig. 67  
Fig. 74N  
Fig. 79



**DE-2567**  
Dental Implant Locator  
Depth Pin Gauge Guide  
Location Plate  
S-type & type.



**DE-2568**  
Rubber Dam Clamps  
Set of 15 Pcs.



**DE-2569**  
Rubber Dam Clamps  
Set of 16 Pcs.



**DE-2570**  
Klein Set of 7 Pcs.  
Fig. 3, Fig. 5, Fig. 6, Fig. 7,  
Fig. 51S, Fig. 137, Fig. 139



**DE-2571**  
Impression Trays Solid  
Set of 6-Pcs.



**DE-2572**  
Impression Trays Perforated  
Set of 8-Pcs.



**DE-2573**  
Disposable Impression Trays  
(plastic) Set of 10-Pcs.



**DE-2574**  
Dental Extracting  
Physics Forceps  
Set of 4-Pcs.



**DE-2575**  
Dental Extracting  
Physics Forceps  
Set of 4-Pcs.

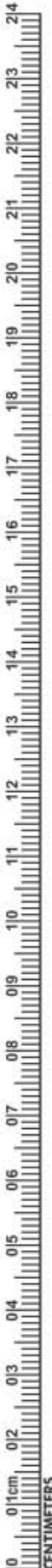

DENTAL INSTRUMENTS SETS



**DE-2576**  
Gracey Curette (Set of 7-Pcs.)  
Hollow Handle with color coated



**DE-2582**  
Silicone Handle Dental Composite  
Filling Instruments Kit 7-Pcs.

DE-2577 Plugger Machtou 1/2 (0.5mm x 0.6mm) Red Silicone  
DE-2578 Plugger Machtou 3/4 (0.8mm x 1.0mm) Grey Silicone



**DE-2579**  
Plugger Dentsply 1/3 Silicon Handle Yellow Color  
**DE-2580**  
Plugger Dentsply 2/3 Silicon Handle in Red Color



**DE-2583**  
Gracey Curette (Set of 6-Pcs.)  
Aluminum Handle color coated



**DE-2581**  
Hemingway Bone Curettes Set of  
4 Hollow Handle with color coated



**DE-2584**  
Lucas Bone Curette D-Ended Set of  
4 Spoons Hollow Handle color coated



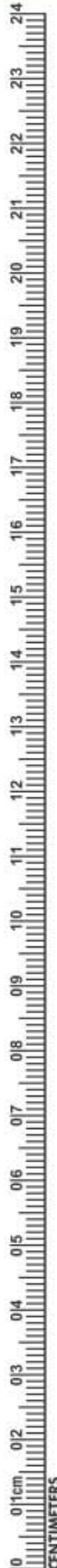

**DE-2585**  
Dental Filling Instruments Set of 5-Pcs.  
Plane Hollow Handle Point Color Coated



**DE-2588**  
P.K. Thomas Set of 5-Pcs.  
Hollow Handle color coated



**DE-2586**  
P.K. Thomas Set of 5-Pcs.  
Solid Handle



**DE-2589**  
Dental Filling Instruments Set of  
6-Pcs. Solid Handle 6mm D-End



**DE-2587**  
Composite Dental Instruments kit 6-Pcs.  
Titanium Coated Composite Scalar Set



**DE-2590**  
Composite Dental Instruments kit 6-Pcs.  
Titanium Coated Composite Scalar Set

DENTAL INSTRUMENTS SETS



**DE-2591**  
Bur Box

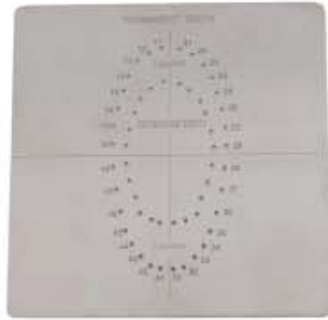

**DE-2592**  
Rubber Dam Template Sheet



**DE-2593**  
Fox Measuring Plate "Set of 2"



**DE-2594**  
Tray Sterilizer 190x100x30



**DE-2595**  
Tray Sterilizer 190x70x25



**DE-2596**  
Tray Sterilizer  
200x150x30



**DE-2597**  
Tray Sterilizer  
90x45x17



**DE-2598**  
Instruments Tray 12 Pcs.



**DE-2599**  
Instruments Tray 8Pcs.



**DE-2600**  
Endodontic Box with Double Cap 200mm x 100mm



- Инструменты для имплантологии
- Implantologie
- Implantologie

- Інструменти для імплантології
- Implantologia
- زراعة الأسنان



**DE-2601**  
**Drills kit (Black Coated)**  
 The Kit Includes:  
**Dental Drills Implant Kit 8 Pcs**  
**Drill Sizes:**  
 2.0mm, 2.5mm, 2.8mm, 3.2mm,  
 3.65mm, 4.2mm, 5.2mm, 5.5mm  
 Marking Depths on the drills  
 for accurate drilling,  
 Sizes 6.0mm, 8.0mm, 10.0mm,  
 11.5mm, 13.0mm & 16.0mm.



**DE-2602**  
**Drill Kit (Polished)**  
 The Kit Includes:  
**Dental Drills Implant Kit 8 Pcs**  
**Drill Sizes:**  
 2.0mm, 2.5mm, 2.8mm, 3.2mm,  
 3.65mm, 4.2mm, 5.2mm, 5.5mm  
 Marking Depths on the drills for  
 accurate drilling,  
 Sizes 6.0mm, 8.0mm, 10.0mm,  
 11.5mm, 13.0mm & 16.0mm.

- The Kit Includes:
- 1.8mm Pilot Drill
  - 1525 (2.0mm)
  - 2535 (3.0mm)
  - 3545 (4.0mm)
  - 4555 (5.0mm)
  - 1828 (2.3mm)
  - 2838 (3.3mm)
  - 3848 (4.3mm)
  - 4858 (5.3mm)
  - 2228 (2.5mm)
  - 3238 (3.5mm)
  - 4248 (4.5mm)
  - 5258 (5.5mm)



**DE-2603**  
 Osseodensification Burs Kits

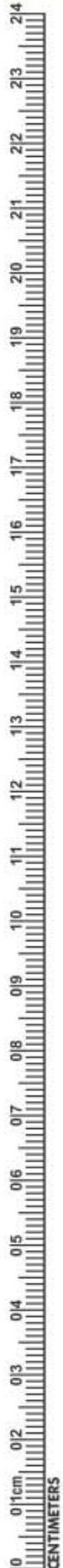

**IMPLANTOLOGY**

- Инструменты для имплантологии
  - Implantologie
  - Implantologie
- Инструменти для імплантології
  - Implantologia
  - زراعة الأسنان



**DE-2604**  
**Compression Expander Screws Kit**

The Kit Includes:  
Kit Includes  
3x Bone Compression Screws  
1x Sinus Elevation Screw (3.5mm)  
Screws are compatible with any brands 4.0mm Torque Wrench / Ratchet Wrench / Adapter's  
Kit Advantages  
Screws are Laser marked to indicate the depth of 8mm, 10mm & 13mm



**DE-2605**  
**Hex Drivers Adapter Kit**

The Kit Includes:  
4 Pcs Hex Drivers Kit Fits Ratchet / Torque Wrench  
2 x 25mm & 2x 2.5mm Long & Short Driver  
Manufactured from High Grade Stainless Steel - Highly Polished



**DE-2606**  
**Bone Expander Kit**

The Kit Includes:  
1) **Expander Screws**  
1.6 / 2.6 mm, 1.9 / 3.0 mm, 2.1 / 3.4 mm  
2.6 / 3.8 mm, 2.9 / 4.3 mm  
With Laser Depth Markings on 8mm, 10mm & 11.5mm.  
2) **Saw Disks**  
7.0 mm, 10.0 mm  
3) **Pilot Drill 1.6mm**  
4) **Hand piece Adapter**  
5) **Ratchet Extender**  
6) **Hand Driver**  
7) **Ratchet Wrench 4.0mm**  
8) **Sterilization Cassette / Box.**



**DE-2607**  
**Bone Compact Kit**

The Kit Includes:  
1) **Twist Drills**  
2.0mm, 2.5mm, 2.8mm 3.2mm, 3.65mm, 4.2mm, 5.2mm  
With Laser Depth Markings on 6.0mm, 8.0mm, 10.0mm, 11.5mm, 13.0mm & 16.0mm  
2) **Ratchet / Wrench Hex Drivers** (Color Coded)  
1.25mm Short / Long, 2.42mm Short / Long  
3) **Contra Angle Hex Drivers**  
1.25mm, 2.42mm  
4) **Parallel Pins** Long & Short  
5) **Drill Extender**  
6) **Marking Drill**  
7) **Ratchet Wrench 6.35mm**  
8) **Sterilization Cassette / Box / Organizer**





- Инструменты для имплантологии
- Implantologie
- Implantologie

- Инструменти для имплантології
- Implantologia
- زراعة الأسنان



DE-2608

**Trimmer Kit**

The Kit Includes:

**1) Trepine Drills**

3.0mm, 4.0mm  
5.0mm, 6.0mm

**2) Tissue Punch**

3.5mm, 4.0mm  
4.5mm, 5.0mm  
5.5mm

**3) Guide Punch**

5.0mm, 6.0mm  
7.0mm

**4) Saw Disks**

7.0mm, 10.0mm

**5) Sterilization Cassette.**



DE-2609

**Bone Compression Kit**

The Kit Includes:

**Convex Compression Screws**

1.6/2.7mm, 2.0/3.3mm  
2.4/3.6mm, 3.1/4.1mm

**Concave Compression Screws**

3.0mm, 3.5mm, 4.0mm

**Spade Marking Drill**

Motor Mount Drivers Long & Short  
Hand Driver  
Ratchet Adapter  
Ratchet Wrench

**Ratchet Wrench**

**Ratchet Adapter**

**Hand Driver**

**Motor Mount Drivers Long & Short**

**Spade Marking Drill**

**Concave Compression Screws**

**Bone Compression Kit**

**DE-2609**

**The Kit Includes:**

**Convex Compression Screws**

**1.6/2.7mm, 2.0/3.3mm**

**2.4/3.6mm, 3.1/4.1mm**

**Concave Compression Screws**

**3.0mm, 3.5mm, 4.0mm**

**Spade Marking Drill**

**Motor Mount Drivers Long & Short**

**Hand Driver**

**Ratchet Adapter**

**Ratchet Wrench**

**DE-2610**

**Surgical Drill Kit**

The Kit Includes:

**1) Twist Drills**

2.0mm, 2.8mm  
3.2mm, 3.65mm  
4.2mm, 4.8mm, 5.2mm

With Laser Depth Markings on 6.0mm,  
8.0mm, 10.0mm, 11.5mm, 13.0mm & 16.0mm

**2) Ratchet / Wrench Hex Drivers (Color Coded)**

1.25mm Short / Long, 2.42mm Short / Long

**3) Parallel Pins**

Long & Short

**4) Motor Mount Hex**

1.25mm, 2.5mm

**5) Ratchet Wrench 4mm**

**6) Sterilization Cassette / Box / Organizer**

**DE-2610**

**Surgical Drill Kit**

The Kit Includes:

**1) Twist Drills**

2.0mm, 2.8mm  
3.2mm, 3.65mm  
4.2mm, 4.8mm, 5.2mm

With Laser Depth Markings on 6.0mm,  
8.0mm, 10.0mm, 11.5mm, 13.0mm & 16.0mm

**2) Ratchet / Wrench Hex Drivers (Color Coded)**

1.25mm Short / Long, 2.42mm Short / Long

**3) Parallel Pins**

Long & Short

**4) Motor Mount Hex**

1.25mm, 2.5mm

**5) Ratchet Wrench 4mm**

**6) Sterilization Cassette / Box / Organizer**



DE-2610

**Surgical Drill Kit**

The Kit Includes:

**1) Twist Drills**

2.0mm, 2.8mm  
3.2mm, 3.65mm  
4.2mm, 4.8mm, 5.2mm

With Laser Depth Markings on 6.0mm,  
8.0mm, 10.0mm, 11.5mm, 13.0mm & 16.0mm

**2) Ratchet / Wrench Hex Drivers (Color Coded)**

1.25mm Short / Long, 2.42mm Short / Long

**3) Parallel Pins**

Long & Short

**4) Motor Mount Hex**

1.25mm, 2.5mm

**5) Ratchet Wrench 4mm**

**6) Sterilization Cassette / Box / Organizer**

**DE-2610**

**Surgical Drill Kit**

The Kit Includes:

**1) Twist Drills**

2.0mm, 2.8mm  
3.2mm, 3.65mm  
4.2mm, 4.8mm, 5.2mm

With Laser Depth Markings on 6.0mm,  
8.0mm, 10.0mm, 11.5mm, 13.0mm & 16.0mm

**2) Ratchet / Wrench Hex Drivers (Color Coded)**

1.25mm Short / Long, 2.42mm Short / Long

**3) Parallel Pins**

Long & Short

**4) Motor Mount Hex**

1.25mm, 2.5mm

**5) Ratchet Wrench 4mm**

**6) Sterilization Cassette / Box / Organizer**

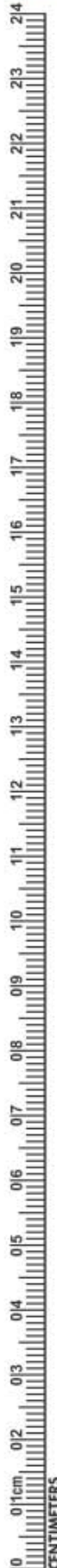

## IMPLANTOLOGY

- Инструменты для имплантологии
- Implantologie
- Implantologie
- Инструменти для имплантології
- Implantologia
- زراعة الأسنان



### DE-2611 Universal Kit 50 PCS

The Kit Includes:

#### 16pcs Conical Drills with Stoppers

- 1.8mm / 2.2mm - S1, 1.8mm / 2.2mm - S3
- 1.8mm / 2.2mm - S5, 1.8mm / 2.2mm - S7
- 2.2mm / 2.7mm - S1, 2.2mm / 2.7mm - S3
- 2.2mm / 2.7mm - S5, 2.2mm / 2.7mm - S7
- 2.3mm / 3.3mm - S1, 2.3mm / 3.3mm - S3
- 2.3mm / 3.3mm - S5, 2.3mm / 3.3mm - S7
- 2.8mm / 4.5mm - S1, 2.8mm / 4.5mm - S3
- 2.8mm / 4.5mm - S5, 2.8mm / 4.5mm - S7

S = Stopper Length

#### Bone Expander Screws

- 1.6mm / 2.6mm, 1.9mm / 3.0mm
- 2.9mm / 3.4mm, 2.3mm / 3.8mm
- 2.9mm / 4.3mm,

#### Titanium Coated Drills

- Drill Bit 2.0mm L 18.50, Drill Bit 2.8mm L 18.50
- Drill Bit 3.65mm L 18.50, Drill Bit 4.2mm L 18.50
- Drill Bit 4.5mm L 18.50, Drill Bit 4.8mm L 18.50
- Drill Bit 5.2mm L 18.50

#### 8pcs Trephine Drills

- Int: 2.0mm, Ext: 3.0mm, Int: 3.0mm, Ext: 4.0mm
- Int: 4.0mm, Ext: 5.0mm, Int: 5.0mm, Ext: 6.0mm
- Int: 6.0mm, Ext: 7.0mm, Int: 7.0mm, Ext: 8.0mm
- Int: 8.0mm, Ext: 9.0mm, Int: 9.0mm, Ext: 10.0mm
- Compression Screw 2.8 / 4.0mm, Compression Screw 4.0mm
- Driver 2.5mm
- Compression Screw 2.0 / 2.8mm, Compression Screw 2.8 / 3.4mm
- Tissue Punch 4.5mm, Tissue Punch 5.8mm
- Pilot Drill 2.0mm
- Drill Extender
- Ratchet Driver 2.5mm, Hand Driver 2.5mm
- Torque Wrench 6.35mm (10-40Ncm)
- Depth Gauge
- Sterilization Cassette / Box



### DE-2612 Conical Implant Drill Kit

The Kit Includes:

#### Drills Sizes:

- 1.8mm / 2.2mm, 2.2mm / 2.7mm
- 2.3mm / 3.3mm, 2.7mm / 3.7mm
- 2.7mm / 4.5mm

#### Stopper Sizes:

- 1.0mm / L 13.0, 2.0mm / L 11.5
- 3.0mm / L 10.0, 5.0mm / L 8.0
- 7.0mm / L 6.0

#### Overall Drills Length:

- 13.0mm (32mm with Shaft)



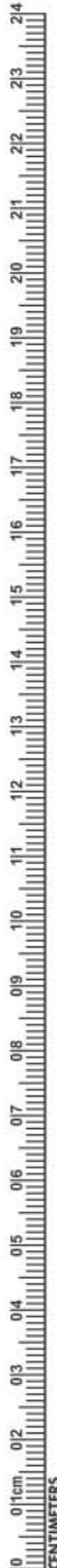

DESCRIPTION	PAGE #	DESCRIPTION	PAGE #	DESCRIPTION	PAGE #
3 PRONG CLASP ADJUSTABLE PLIER TC	107	CARVERS FILLING INSTRUMENTS	69	FLAT NOSE PLIER WITH SERRATION	105
ACORN FILLING INSTRUMENTS	52	CARVERS INSTRUMENTS	73	FLOHR ROOT ELEVATORS	20
ADAM PLIER WITH TC	102	CARVERS	71	FLUCH-CUT DISTAL AND CUTTING PLIERS	100
ADAMS PLIER ROUND BOX	100	CASTROVIEJO NEEDLE HOLDERS	86	FOERSTER DRESSING FORCEPS	
ADAMS PLIERS FOR BENDING WIRE	100	CASTROVIEJO SCISSORS	84	FORCEP JAR	148
ADAMS, SMALL WIRE BENDING AND LOOP FORMING PLIERS	99	CEMENT SPATULAS	75	FREEDMAN "DUCKHEAD" IMPLANTOLOGY INSTRUMENTS	112
ADERER FACEBOW LOOP FORMING PLIERS	101	CHEEK RETRACTOR LONG	80	FREEDMAN BURMISHERS IMPLANTOLOGY INSTRUMENTS	112
ADERER LARGE WIRE BENDING AND LOOP FORMING PLIERS	100	CHEEK RETRACTOR	78	FREER PERIOSTEEL ELEVATORS	95
ADERER PLIER	101	CHEEK RETRACTORS, MINNESOTA	80	FRIEDMAN BONE ROUNDER	14
ADSON BROWN TWEEZERS	32	CHEEK RETRACTORS, RETRACTOR IVORY	80	FRIEDMANN ROOTS ELEVATOR	21
ADSON CARBIDE TIPPED TISSUE FORCEPS	133	CHEEK RETRACTORS, TONGUE DEPRESSORS	80	GAUGE FOR MEASURING	109
ADSON NEEDLE HOLDERS	86	CHISELS HOES FILLING INSTRUMENTS	74	GERALD TWEEZERS	31
ADSON TWEEZERS	32	CLAMP OSTEOMETER	109	GILLES TWEEZERS	31
ADSON-TC TWEEZERS	32	CLAPPISONFRAHAM RESTORATIVE INSTRUMENTS	70	GILLIES NEEDLE HOLDER WITH SCISSORS	
ALLEN PERIOSTEEL ELEVATORS	95	CLAW-LIFT ROOTS ELEVATOR	22	GOLDMAN FOX EXPLORERS	36
ALLIS 4:5 HAEMOSTATIC FORCEPS	87	COHEN UNIVERSAL FORCEPS	10-11	GOLDMAN FOX MERRIT B EXPLORERS	36
ALLIS-BABY 3:4 HAEMOSTATIC FORCEPS	87	COLLEGE CURVED	32	GOLDMAN FOX UNIVERSITY OF MICHIGAN EXPLORERS	36
AMALGAM CARVERS	56-57, 70-71	COLLEGE TWEEZER	32	GOLDMAN FOX WILLIAMS EXPLORERS	36
AMALGAM FILES	71	COLLEGE WITH LOCK TWEEZERS	31	GOLDMAN PERIODONTAL INSTRUMENTS	58
AMALGAM INSTRUMENTS & SCALPEL HANDLES	92	COLLINS TONGUE FORCEPS	31	GOLDMAN-FOX PERIOSTEEL ELEVATORS	95
AMALGAM INSTRUMENTS	93	COMPOSITE/PLASTIC FILLING INSTRUMENTS	49-50, 54	GOLDMAN-FOX SCISSORS	83-84
AMALGAM WELL MATRIX RETAINERS	93	CONDENSER INSTRUMENTS	118	GOLDMAN-FOX SET	61
AMALGAM WELL	93	CONDENSER MORTONSON FILLING INSTRUMENTS	50	GOLDSTEIN INTERPROXIMAL EXCAVATOR	67
ANATOMICAL CARVER	71	CONTOURING INSTRUMENT IMPLANTOLOGY INSTRUMENTS	111	GRACEY AFTER FIVE	42
ANDREW RESTORATIVE INSTRUMENTS	70	CONTOURING PLIER	101	GRACEY CURETTE INSTRUMENTS	62
ANGLE FORMERS	72	COSMETIC CONTOURING	113	GRACEY CURETTE SET CASSETTES	147
ANGLED DIRECT BOND BRACKET REMOVER TC	106	COTTON HOLDER	148	GRACEY CURETTE	43
ANISWORTH CLAMPS FORCEPS	88	COUPLAND ROOT ELEVATORS	17	GRACEY MINI FIVE	42
ANTERIOR FILLING INSTRUMENTS	89	COUPLAND ROOT ELEVATORS	18	GRACEY PERIODONTAL INSTRUMENTS	39
ANTERIOR	47	CRANE-KAPLAN TWEEZERS	32	GRACEY SET OF 7 PCS	40-41
APEXO ROOT ELEVATORS	15-19	CRANE-KAPLAN PERIODONTAL INSTRUMENTS	59	GRAFT PACKER, CONCAVE TIPS	125
APICAL ROOT ELEVATORS	19	CRILE NEEDLE HOLDERS	85	GREGG IMPLANTOLOGY INSTRUMENTS	111
ARCH FORMING PLIERS	104	CRILE-WOOD NEEDLE HOLDERS	85-86	GRITMAN CEMENT SPATULAS	75
ARTICULATORS	77	CROWN AND BAND CONTOURING PLIERS	105	GROSS MAIER DRESSING FORCEPS	
A-TRAUMATIC EXTRACTION SET	03	CROWN REMOVER	90	GUM SCISSORS	
ATRAUMATIC TWEEZERS	31	CROWN SPREADERS	90	HAEMOSTATIC FORCEPS & TOWEL CLAMPS	87
BACK ACTION FILLING INSTRUMENTS	52	CRYSER EXTRACTING FORCEPS	20	HALSEY NEEDLE HOLDERS	85-86
BACKHAUS HAEMOSTATIC FORCEPS	87	CRYSER ROOTS ELEVATOR	23	HALSTEAD MOSQUITO HAEMOSTATIC FORCEPS	87
BACOLITE HANDLE WAX KNIVES	76	CURETTE COLUMBIA	43	HALSTEAD MOSQUITO NEEDLE HOLDERS	86
BALDWIN FILLING INSTRUMENTS	49	CURETTE INSTRUMENTS	63	HALTEPINZETTE WITH LOCK	134
BALL FILLING INSTRUMENTS	52	CURETTE MCCALL	43	HAMMER HEAD TIE BACK PLIER	104
BALL HOOK CRIMPING PLIER	105	CURETTE	60	HANDLES FOR MOUTH MIRRORS	30
BAND PUSHER	90	CURETTES SET OF 8 PIECES	43	HARD WIRE CUTTERS	107
BAND REMOVING PLIER	99	CURETTES	40-43, 61-62	HARRIS EXTRACTING FORCEPS	11
BAND SEATER AUTO CLEAVABLE	97	CUTTING INS PERIODONTAL INSTRUMENTS	39	HARTMANN (BABY MOSQUITO) NEEDLE HOLDERS	86
BAND SEATING PLIER	104	DARBY-PERRY EXCAVATORS	65	HATCHETS FILLING INSTRUMENTS	68
BANDS & CROWNS PLIER	101	DE LA ROSA PLIERS WITH GROOVED	105	HEAT CARRIERS	46
BASINS FOR BONE	138	DE LA ROSA PLIERS	105	HEBER ROOTS ELEVATOR	24
BAUMGARTER NEEDLE HOLDERS	85	DEAN SCISSORS	84	HEIDBRINK ROOT ELEVATORS	20-21, 26
BAUMGARTNER NEEDLE HOLDERS	86	DEBAKEY ATRAUMATIC TISSUE FORCEPS	133	HEIDMANN PERIODONTAL INSTRUMENTS	39
BAYONET ROOTS ELEVATOR SET	21	DEEP BOWL	148	HEMINGWAY CURETTE INSTRUMENTS	63
BEAVERTAIL FILLING INSTRUMENTS	52	DEEP ROOT PICK FORCEPS (APICAL SET OF 9)	04	HEMINGWAY TWEEZERS	32
BEEBEE NEEDLE HOLDERS	85	DELICATE NEEDLE HOLDERS	85	HOES	71
BEIN ROOT ELEVATORS	15-18, 24	DELUXE BRACKET HOLDER TWEEZERS	96	HOLLANBACK PERIODONTAL INSTRUMENTS	39
BEYER BONE ROUNDER	14	DENHARD CHEEK RETRACTORS	79	HOLLANBACK FILLING INSTRUMENTS	50
BINANGLE FILLING INSTRUMENTS	74	DENTAL MIRROR PERIODONTAL INSTRUMENTS	39	HOLLANBACK IMPLANTOLOGY INSTRUMENTS	114
BIRD BEAK ANGLED BENDING PLIER	103	DENTAL SYRINGES	13	HOLLANBACK RESTORATIVE INSTRUMENTS	70
BIRD BEAK PLIER WITH TC	102	DERF NEEDLE HOLDERS	85	HOLLOW HANDLE	132
BIRD BEAK WIRE BENDING & CUTTING PLIERS	101	DERF NEEDLE HOLDERS	86	HOLLOW WARE	148
BIRD BEAK WIRE BENDING PLIER	100	DIRECT BOND BRACKET HOLDER TWEEZERS	96	HOLLOWCHOP CONTOURING PLIERS	106
BIRD BEAK WITH CUTTER PLIERS	104	DIRECT BONDING BRACKET HOLDERS	96	HOOK CRIMPING PLIER ANGLED STRAIGHT TC	107
BLACK FILLING INSTRUMENTS	50	DIRECT BONDING BRACKET REMOVER PLIER TC	106	HOOK KNIVES	76
BLACK TITANIUM COLOUR COATED INSTRUMENTS	110-111	DIRECT BRACKET REMOVER TC	107	HOW PLIER CURVED WITH TC	103
BLADE AND PUSHER	126	DISCOID-CLEOID CARVER	71	HOW PLIER CURVED	99, 104
BLUMENTHAL BONE ROUNDER	14	DISTAL END CUTTER REGULAR WITH TC	102	HOW PLIER STRAIGHT WITH TC	103
BOGHOSIAN FILLING INSTRUMENTS	49	DISTAL END CUTTER, SAFETY HOLD PLIER		HOW PLIER STRAIGHT	103
BOGHOSIAN IMPLANTOLOGY INSTRUMENTS	111	(IDEAL FOR CUTTING WIRE) TC	107	HOWARD PERIOSTEEL ELEVATORS	95
BOLEY GAUGE	109	DISTAL END, WIRE CUTTERS & BRACKET REMOVER PLIERS	107	HYGIENIST PERIODONTAL INSTRUMENTS	58
BONE BRACKET GAUGE	96	DOUBLE ENDED CEMENT SPATULA	98	HYGIENIST-JACQUETTE PERIODONTAL INSTRUMENTS	58
BONE CARRIER TITANIUM	124	DRESSING TWEEZERS	31-32	HYGIENIST-TOWNER PERIODONTAL INSTRUMENTS	58
BONE CRUSHER	138, 140	ELASTIC SEPARATING PLIER	107	HYLIN CEMENT SPATULAS	75
BONE EXPANDER SCREW & SURGICAL KITS	141	ELASTOMERIC LIGATURE PLACING FORCEPS		HYLIN ROOTS ELEVATOR	23
BONE FILES	94	WITH GROOVE FALCON	107	IMPLANT GAGES	108
BONE GRAFT/CARRIER TITANIUM	128	ELLIOT MATRIX RETAINERS	91	IMPLANT SINUS LIFT INSTRUMENTS	117, 122
BONE GRAFTING INSTRUMENTS COMPACTOR /TAMPERS	125	ENDED CHEEK RETRACTORS	79	IMPLANT	123
BONE GRAFTING INSTRUMENTS	126-127	ENDODONTIC BOX	148	IMPLANTOLOGY IMPLANTOLOGY INSTRUMENTS	112
BONE INJECTORS, COLLECTORS & SUCTION TUBE	142	ENDODONTICS INSTRUMENTS	47	IMPLANTOLOGY INSTRUMENTS	111
BONE MILL	138	ENGLISH PATTERN KLEIN #3 PEDODONTIC UNIVERSAL FORCEPS	08	IMPLANTOLOGY	108-110
BONE ROUNDER	14	EXAMINATION KIT SET OF 3 PIECES	34	IMPRESSION TRAYS	143-146
BONE SCRAPER STRAIGHT & CURVED	138	EXAMINATION SET OF 4 PIECES	34	INSTRUMENTS BOX	148
BONE SPOON/PACKER	125	EXAVATORS	37	INSTRUMENTS CASSETTES & STANDS	147
BONE THICKNESS GAUGE	109	EXCAVATOR PERIODONTAL INSTRUMENTS	39	INTERPROXIMAL CARVER IMPLANTOLOGY INSTRUMENTS	111
BONE UNIVERSAL KIT	141	EXCAVATORS INSTRUMENTS SET OF 11 PIECES	57	INTERPROXIMAL OFF-ANGLE FILLING INSTRUMENTS	49
BRACKET REMOVER ANGULATED PLIER	103	EXCAVATORS INSTRUMENTS	64-67	INTRALIGAMENTAL ANESTHESIA SYRINGE	13
BRACKET REMOVER PLIER STRAIGHT	103	EXCAVATORS	64	IRIS SCISSORS	83-84
BRACKET REMOVER PLIERS ANGLED WITH TC	102	EXPLORER PERIODONTAL INSTRUMENTS	39	IVORY LIGHT WEIGHT CLAMPS FORCEPS	88
BRACKET REMOVER PLIERS STRAIGHT WITH TC	102	EXPLORERS INSTRUMENTS	35	IVORY MATRIX RETAINERS	91
BRACKET REMOVING PLIER ROUND BOX	99	EXPLORERS	33-45	IVANSON SPRING CALIPER	109
BRACKET REMOVING PLIER	99	EXTRACTING FORCEPS (AMERICAN PATTERN)	10-14	JACQUETTE SCALERS PERIODONTAL INSTRUMENTS	59
BREWER CLAMPS FORCEPS	88	EXTRACTING FORCEPS (ENGLISH PATTERN)	01-02, 05-07	JARA BEAK PLIER	104
BURNISHER FILLING INSTRUMENTS	49	EXTRA-FLEX IMPLANTOLOGY INSTRUMENTS	114	JENNINGS CHEEK RETRACTORS	79
BURNISHER FILLING INSTRUMENTS	49	FALCON BEAK CONTOURING PLIERS	100	JOHNSON CONTOURING PLIERS	100
BURNISHER UNIVERSITY OF MICHIGAN AMALGAM CARVERS	56	FARABEUF RETRACTOR	82	JONES HAEMOSTATIC FORCEPS	87
BURNISHERS FILLING INSTRUMENTS	52-53	FELDMAN RETRACTOR	82	JOSEPH SCISSORS	84
BURNISHERS IMPLANTOLOGY INSTRUMENTS	112	FILES FILLING INSTRUMENTS	53	KELLY HAEMOSTATIC FORCEPS	87
BUSER PERIOSTEEL ELEVATORS	95	FILLING INS PERIODONTAL INSTRUMENTS	39	KELLY SCISSORS	83-84
CARRY FORCEPS	134	FILLING INSTRUMENTS	37, 44, 49-55, 69, 72	KELLY-RANKIN HAEMOSTATIC FORCEPS	87
CARVER HOLLANBACK AMALGAM CARVERS	56	FLAT NOSE PLIER SMOOTH	105	KEYS FOR IMPLANT SCREW	139

INDEX

DESCRIPTION	PAGE #	DESCRIPTION	PAGE #	DESCRIPTION	PAGE #
KIDNEY TRAY WITH COVER (ENGLISH PATTERN)	148	ORTHO LIGHT SCALER HEAVY	97	SINUS LIFT INSTRUMENT	118-121
KIDNEY TRAYS	148	ORTHO LIGHT SCALER SINGLE ENDED	98	SINUS LIFT SET STAND	147
KILNER (RAGNELL) SCISSORS	84	ORTHO LIGHT SCALER	97	SINUS WINDOW BONE TAMPERS	127
KLEINERT-KUTZ BONE ROUNDER	14	ORTHODONTIC INSTRUMENTS	96-98	SINUSLIFT INSTRUMENTS	118
KOPP ROOTS ELEVATOR	23-24	ORTHOLITE LIGATURE DIRECTOR SCALER	98	SIOVELAND RETAINERS TOFFLEMIRE-JUNIER MATRIX RETAINERS	91
KRARNER-NEVINS BONE CHISEL	94	OSTEOMETER MEASURING FORCEPS	96	SMAHA ELASTOMERIC LIGATURE PLACING FORCEPS	107
LA GRANGE SCISSORS	83-84	OSTEOTOME CONVEXES / CONCAVE / CONIQUES	135-136	SPENCER SCISSORS	84
LADMORE FILLING INSTRUMENTS	52	OVAL SPOONS/DARBY-PERRY	65	SPIRIT LAMP	148
LADMORE IMPLANTOLOGY INSTRUMENTS	112	P.K. THOMAS WAXING INSTRUMENTS	73	SPOON AND PUSHER (TRINOVO)	128
LAP-JOINT THREE PRONG PLIER	106	PALATAL ARCH PLIER	105	SPOON AND PUSHER WITH SAFETY STOP	128
LAXUTOR ROOT ELEVATORS	19	PALMER CLAMPS FORCEPZ	88	SPOONS	64
LE CRON CEMENT SPATULAS	75	PDL ELEVATORS	28-29	SPREADERS	46
LESSMANN	76	PEDIATRIC TOOTH EXTRACTING FORCEPS SET	09	STANDARD LIGATURE CUTTER TC	106
LIGATURE FORMING PLIERS	101	PERIODONTAL FILLING INSTRUMENTS	53	STEP PLIERS WITH TC	103
LIGHT WIRE BIRD BEAK LONG PLIER WITH TC	102	PERIODONTAL INSTRUMENTS	37, 39, 58, 60, 95	STERILIZING DRUM	148
LIGHT WIRE BIRD BEAK LONG PLIER	104	PERIODONTAL PROBES	46, 48	STOP V BENDING PLIER	105
LIGHT WIRE BIRD BEAK PLIERS	104	PERIOSTEALS ELEVATOR	95, 129-130	STRAIGHT DIRECT BOND BRACKET REMOVER TC	107
LIGHT WIRE CUTTER MICRO WITH TC	102	PERIOTOME ROOTS ELEVATOR	26	SURGICAL CHISELS	123
LIGHT WIRE PLIER	104	PERRY TWEEZER	31-32	SURGICAL TWEEZERS	31
LINDO LEVIAN ROOT ELEVATORS	20	PESTERIOR BEND REMOVER PLIER LONG	103	SUTURE PLIERS SUTURE FORCEPS	133
LINGUAL / PALATAL ARCH FORMING PLIERS	101	PESTERIOR BEND REMOVER PLIER MEDIUM	103	SYNDESMOTOMES ROOTS ELEVATOR	26
LINGUAL PLIER LONG HANDLE	106	PESTERIOR BEND REMOVER PLIER SHORT	103	TAMPER	126
LINGUAL PLIER WEINGART	106	PIN & LIGATURE CUTTERS TC	106	TANNER FILLING INSTRUMENTS	52, 69
LINGUAL WEINGART PLIER	106	PIN HOLDING PLIER TC	107	TANNER IMPLANTOLOGY INSTRUMENTS	114
LINING APPLICATOR DOUBLE END	55	PIN-TWEEZERS	134	TC GRIPPER CARBIDE	133
LOCKLIN SCISSORS	84	PLAIN MIRRORS	30	THARP RESTORATIVE INSTRUMENTS	70
LONDON COLLEGE TWEEZERS	31	PLASTER KNIFE 76 SPECIAL INOX	76	THREE PRONG PLIERS REGULAR	106
LORNA HAEMOSTATIC FORCEPS	87	PLIERS FOR ORTHODONTICS & PROSTHETICS	99-106	TISSUE GRAFT FORCEP SERRATED TEETH	133
LUCAS	132	PLUGGER PERIODONTAL INSTRUMENTS	39	TISSUE MEMBRANE FORCEPS	132, 134
LUER BONE ROUNDER	14	PLUGGER BLACK AMALGAM CARVERS	56	TISSUE PUNCH FORCEPS	134
LUKS	47	PLUGGERS	45, 48	TISSUE PUNCH STRAIGHT & CURVED	138
LUXATOR ROOT ELEVATORS	15-16, 21	PLUGGERS/CONDENSERS FILLING INSTRUMENTS	50	TOFFLEMIRE-SENIOR MATRIX RETAINERS	91
LUXIER ROOTS ELEVATOR	22	PLUGGERS/CONDENSERS	51	TOFFLEMIRE-UNIVERSAL MATRIX RETAINERS	91
MAGNIFYING MIRRORS	30	POINTED CURETTE	60	TORQUE WRENCH & RATCHET	139
MANUAL CROWN REMOVER	90	POINTED PROBES SINGLE ENDED	36	TOWNER PERIODONTAL INSTRUMENTS	58
MARCOTTE LOOPING PLIER	105	POSTERIOR	48	TOWNER-JACQUETTE PERIODONTAL INSTRUMENTS	58
MARGIN TRIMMERS	72	POSTERIOR BAND REMOVER PLIERS	102	TREPINE DRILL SET OF EIGHT PIECES	137
MARGINAL RIDGE & EMBRASURE SHAPING INSTRUMENT	113	POTT ROOTS ELEVATOR	25	TUFTS FILLING INSTRUMENTS	49
MARKLEY PLUGGERS/CONDENSERS	51	POWER CROWN REMOVER LIFT	90	TUNNELIERUNGS INSTRUMENT	126
MARQUETTE FILLING INSTRUMENTS	50	PRICHARD PERIOSTEAL ELEVATORS	95	TWEED / ANGLE FORMING AND TORQUING PLIERS	101
MARYAM TWEEZERS	32	PROBES DOUBLE ENDED	35	TWEED / ANGLE RECTANGULAR ARCH FORMING & TORQUING PLIERS	100
MATHIEU NEEDLE HOLDERS	86	PROBES SINGLE ENDED	34	TWEED ARCH FORMING PLIER TC	102
MATRIX RETAINERS	91	QUETIN FILLING INSTRUMENTS	49	TWEED CUTTER PLIER	104
MAYO NEEDLE HOLDERS	85	RASPATOR, BENOUE	131	TWEED LOOP FORMIN PLIERS	100
MAYO SCISSORS	83	RASPATOR, FREER	129, 131	TWEED LOOP FORMING PLIER TC	105
MAYO-HEGAR NEEDLE HOLDERS	85-86	RASPATOR, MICRO FREER	131	TWEED LOOP FORMING PLIERS	99
MEAD 1A BONE ROUNDER	14	RASPATOR, MICRO RASPATOR / CHISEL	131	TWEED LOOP PLIER	104-105
MEAD BONE FILES	94	RASPATOR, MICRO-FREER	129	TWEEZER PERIODONTAL INSTRUMENTS	39
MEASURING LOOP	109	RASPATOR, NORDBERG	131	TWEEZERS	31
MEASURING LOOP CASTROVIEJO	109	RASPATOR, PRICHARD	124	TWEEZERS	32
MEDIUM CEMENT CEMENT SPATULAS	75	RASPATOR, RASPIRATORY PERIOSTEAL ELEVATORS	95	TWEL-ON ELASTIC MODULE INSTRUMENT	97
MEDIUM PLACING/CONDENSING IMPLANTOLOGY INSTRUMENTS	114	RASPATOR, WAUTIER	131	UNIVERSAL DOLPHIN STYLE WIRE BENDING & CUTTING PLIERS	99
MEMBRANE POSITIONING INSTRUMENTS	118	RASPATOR, WILLIGER PERIOSTEAL ELEVATORS	95	UNIVERSAL FILLING INSTRUMENTS	49
MEMBRANE TWEEZERS KUEHNE	134	RASPATORY CHIPPING	131	UNIVERSAL FILLING INSTRUMENTS	54
MERIAM TWEEZERS	31	RASPATORY MICRO MOLT	131	UNIVERSAL NEEDLE HOLDERS	85
MERRIT A EXPLORERS	36	RASPATORY MOLT	131	UNIVERSITY OF MICHIGAN EXPLORERS	36
MERRIT B EXPLORERS	36	REGULAR TWEED ARCH FORMING PLIERS	104	UTILITY PLIER WEINGART TC	107
MERSHON CROWN REMOVER	90	RESTORATIVE INSTRUMENTS	51-53, 68, 70-72	V BEND STOP PLIER TC	106
METZENBAUM NEEDLE HOLDERS	85	RETRACTOR WITH ERGO GRIP	90	W BARRY ROOTS ELEVATOR	25
METZENBAUM SCISSORS	83	RETRACTORS - MOUTH GAGS	78-79	WAHL BONE FILES	94
MICOR ADSON TISSUE FORCEP	133	RETRACTORS	80-82	WALDSAVHS WIRE BENDING AND CUTTING PLIERS	101
MICRO IRIS SCISSORS	83	RETRACTORS CHEEK RETRACTOR COMBINATION COMBINATION	81	WALL FILLING INSTRUMENTS	69
MICRO-FRIEDMAN BONE ROUNDER	14	RETRACTORS COMBINATION	81	WANGEN HOLDER	78
MILLER BONE FILES	94	RETRACTORS, LANGENBECK	82	WARD AMALGAM CARVERS	56
MILLER TWEEZERS	32	RETRACTORS, MINI-LANGENBECK	81	WARD FILLING INSTRUMENTS	69
MILLER	132	RETRACTORS, UNIOUE	81	WAX KNIVES	76
MINI LIGATURE CUTTERS	100	RETRO FILLING	48	WEDELSTAEDT	71
MINI PIN & LIGATURE CUTTER TC	106	REVERSED LIGATURE CUTTER ANGLED	102	WEINGART GENERAL UTILITY PLIER LONG MOUTH WITH TC	103
MIXING SPATULA WITH SHOVEL	124	RHODIUM MIRRORS	30	WEINGART PLIER MEDIUM	99-101
MODIED MCCALL	60	ROCHESTER-KOCHER 1X2 HAEMOSTATIC FORCEPS	87	WEINGART PLIER REGULAR WITH TC	103
MOLT BONE FILES	94	ROCHESTER-PEAN HAEMOSTATIC FORCEPS	87	WEINGART PLIER SLIM WITH TC	102
MOLT PERIOSTEAL ELEVATORS	95	ROOT ELEVATOR	15-29	WEINGART PLIER UNIVERSAL WITH TC	103
MORTONSEN FILLING INSTRUMENT	55	ROOT PLANNING FILES	94	WEINGART PLIER UTILITY WITH TC	103
MOUTH GAG MOLT	78	ROOT PLANNING FILES & BONE FILES	94	WEITLANDER CHEEK RETRACTORS	79
MOUTH MIRROR	37	ROSER-KÖNIG CHEEK RETRACTORS	79	WEITLANER CHEEK RETRACTORS	79
MSY CEMENT SPATULAS	75	ROUND NOSE PLIER	104	WERDELSTAEDT FILLING INSTRUMENTS	79
MULTIFUNCTIONAL METER	108	ROUNDED CONE	73	WESTON CEMENT SPATULAS	75
NAKAWALNL DENTAL LABORATORY INSTRUMENTS	77	ROUNDED-CONE FILLING INSTRUMENTS	49	WIDE MATRIX RETAINERS	91
NANCE LOOP FORMING PLIERS	99	RUBBER DAM CLAMPS	89	WILLIAM PROBE SET	38
NANCE PLIER	105	RUBBER DAM CLAMPS FORCEPS	89	WILLIAMS EXPLORERS	36
NARROW MATRIX RETAINERS	81	RUSSIAN LONG TISSUE FORCEPS	134	WINGURT PLIER SLIM	105
NEEDLE HOLDERS	85-86	RUSSIAN TISSUE FORCEPS	134	WINGURT UTILITY PLIER	105
NEUMANN SCISSORS	84	SCALER TRAY	148	WINTER ROOTS ELEVATOR	25
NOYES SCISSORS	84	SCALERS/CURETTE SETS	60	WIRE BENDING & LOOP FORMING PLIERS	99
OCCUSAL ANATOMY INSTRUMENT	113	SCALERS/CURETTE SETS INSTRUMENTS	61	WISDOM ROOTS ELEVATOR	21
OHL PERIOSTEAL ELEVATORS	95	SCHURE BAND SEATER	97	WOODEN HANDLE	76
OLSEN-HEGAR NEEDLE HOLDER WITH SCISSORS	81	SEPARATING ELASTIC PLIER	88	WOODSON FILLING INSTRUMENTS	49
OREGON PLUGGERS/CONDENSERS	51	SELIDIN PERIOSTEAL ELEVATORS	95	YOUNG PLIER WITH GROOVED	105
ORTHO BAND PUSHER SCALER	98	SELIDIN RETRACTOR	82	YOUNG TONGUE FORCEPS	99
ORTHO INSTRUMENT	97	SELIDIN ROOT ELEVATORS	15-18, 25	YOUNG WIRE BENDING & LOOP FORMING PLIERS	99
ORTHO LIGATURE DIRECTOR SINGLE ENDED	98	SELF LOCKING GROOVED	133	ZAHLE CEMENT SPATULAS	75
ORTHO LIGHT BAND PUSHER SCALER	97-98	SELF-LOCKING TWEEZER	32		
ORTHO LIGHT DOUBLE ENDED LIGATURE DIRECTOR SCALER	98	SEMKEN TAYLOR TWEEZERS	31		
ORTHO LIGHT DOUBLE ENDED LIGATURE DIRECTOR	98	SICKLE PERIODONTAL INSTRUMENTS	39		
ORTHO LIGHT DOUBLE ENDED LIGATURE SCALER	98	SICKLE SCALERS INSTRUMENTS	58		
ORTHO LIGHT DOUBLE ENDED LIGATURE SCALER/DIRECTOR	98	SINGLE ENDED PROBE	33		
ORTHO LIGHT LIGATURE DIRECTOR DOUBLE ENDED	98	SINUS LIFT ELEVATOR	115-116		
ORTHO LIGHT SCALER DOUBLE ENDED	97				





# ASIM

## Instruments

A SOURCE OF QUALITY INSTRUMENTS

Manufacturers, & Exporters of Surgical Dental, Orthodontic,  
Hollow Wears & Manicure Instruments.

Airport Road P.O. Gohadpur, Sialkot-51310-Pakistan.

Tell: +92-52-4270310

Cell: +92-300-8617050

E-mail: [asim@asiminst.com](mailto:asim@asiminst.com)

[info@asiminst.com](mailto:info@asiminst.com)

URL: [www.asiminst.com](http://www.asiminst.com)

